



Make your space work.

State of New York

The HON Company Price & Specification Guide October 2021

Make your space work.

HON®



2021 List Pricer

SHARED SPACES

Tables | Education | Seating | Workplace Tools

Effective Date
October 2021

LIST PRICER

Effective Date: October 2021

- All illustrations and specifications in this publication are based on the latest product information available at the time of print. For the most recent version, please go to www.hon.com.
- Software support packages furnished to the customer, either by The HON Company or by another source, which support the sale of HON products are superseded by printed price lists.
- All dimensions shown in this publication are nominal.
- Pricing is subject to change without notice.
- All orders are subject to prices in effect at the time of order.
- Ordering information appears at the beginning of a section complete with examples on how to specify. These specifying information pages are referenced at the bottom center of product pages.
- HON Full Lifetime Warranty applies unless otherwise noted.
- HON nationwide customer service:
Phone: (800) 833-3964

HON LIST PRICER

Table of Contents

INTRODUCTION

| | |
|---|-------|
| Table of Contents..... | 1-3 |
| Additions..... | 4 |
| Discontinuations..... | 5 |
| HON Full Lifetime Warranty Information..... | 6 |
| HON Limited 5-Year Warranty Information..... | 7 |
| Ordering Information..... | 8 |
| Integrated Design Solutions..... | 9 |
| Tailored Solutions Ordering Information..... | 10 |
| Customer's Own Material Ordering Information..... | 11-12 |
| Partnership Textile Information..... | 13 |
| Paint Program..... | 14 |
| Environmental Statement..... | 15 |
| Important Information..... | 16 |
| Legend..... | 17 |
| Fabric Patterns & Codes..... | 18 |
| Lead Times..... | 19 |
| Fabric Patterns & Codes..... | 20-22 |
| Panel Fabric Patterns & Codes..... | 23-24 |

TABLES

| | |
|--|-------|
| Arrange® | 26 |
| Arrange® Café Tables Ordering Information | 27 |
| Arrange® Café Table Tops..... | 28 |
| Arrange® Café Table Bases..... | 29 |
| Arrange® Café Accessories..... | 30 |
| Between™ Tables | 31 |
| Between™ Ordering Information | 32 |
| Between™ Table Tops..... | 33 |
| Between™ Table Bases..... | 34 |
| Between™ Rectangular Table Tops..... | 35 |
| Between™ Table Bases for Rectangular Tops..... | 35 |
| Between™ Nesting Tables..... | 36 |
| Between™ Shared Components..... | 36 |
| Between™ Accessories..... | 37 |
| Birk™ Tables | 38 |
| Birk™ Ordering Information | 39 |
| Birk™ Table Tops..... | 40 |
| Birk™ Bases..... | 41 |
| Birk™ Personal Table..... | 42 |
| Cantilever Table | 43 |
| Flock® | 44 |
| Flock® Collaborative Tables Ordering Information | 45 |
| Flock® Collaborative Solutions Table Specifying Information | 46 |
| Flock® Collaborative Laminate Table Tops..... | 47 |
| Flock® Collaborative Table Bases..... | 48 |
| Flock® Collaborative Tables..... | 49-50 |
| Flock® Collaborative Accessories..... | 51 |
| Huddle | 52 |
| Huddle Ordering Information | 53 |
| Huddle Multi-Purpose Tables | 54 |
| Huddle Typical..... | 55-56 |
| Huddle Multi-Purpose Table Tops..... | 57-58 |
| Huddle Multi-Purpose Table Bases..... | 59 |
| Huddle Mobile Laptop Table..... | 60 |
| Huddle Table Accessories..... | 61 |
| Cable Management..... | 61 |
| Interlink IQ Electrical..... | 62 |

| | |
|--|---------|
| 4-Trac Hardwire Electrical System..... | 63-64 |
| Huddle Power and Cable Management..... | 65 |
| Occasional Tables | 66 |
| Laminate Occasional Tables Options | 67 |
| Laminate Occasional Tables..... | 68 |
| Laminate Contemporary Occasional Tables..... | 69 |
| Motivate® | 70 |
| Motivate® Tables Specifying Information | 71 |
| Motivate® Fixed Height Tables..... | 72 |
| Motivate® Nesting Tables..... | 73 |
| Motivate® Adjustable Height Tables..... | 74 |
| Motivate® Shared Components..... | 75-76 |
| Interlink IQ Electrical..... | 77 |
| 4-Trac Hardwire Electrical System..... | 78-79 |
| Optional Electrical Accessories..... | 80 |
| Preside® | 81 |
| Preside® Ordering Information | 82 |
| Preside® Specifying Information | 83-92 |
| Preside® Grommet Cutout Placement..... | 93 |
| Preside® Laminate Table Tops..... | 94-95 |
| Preside® Laminate Bases..... | 96-97 |
| Preside® Metal Bases..... | 98-100 |
| Preside® Laminate Bases..... | 101 |
| Preside® Metal Bases..... | 102 |
| Preside® Collaborative Tables..... | 103 |
| Preside® Ganging Tables..... | 104 |
| Preside® Collaborative Tables..... | 105 |
| Preside® Ganging Tables..... | 106 |
| Preside® Mobile Collaborative Tables..... | 107 |
| Preside® Team Touchdown Tables..... | 108 |
| Preside® Ancillary..... | 109 |
| Preside® Laminate Storage..... | 110-111 |
| Modular Components..... | 112 |
| Modular Components Back Panels..... | 112 |
| Wall Mount Storage..... | 113-114 |
| Preside® Laminate Shared Components..... | 115 |
| Cable Management..... | 116 |
| Preside® Table Power Accessories..... | 117-118 |
| Preside® Laminate Tables..... | 119 |
| Preside® Laminate Tables — Pre-defined Typical..... | 120 |
| Scramble™ Occasional Tables | 121 |
| Scramble™ Options | 122 |
| Scramble™ Coffee Tables..... | 123 |
| Scramble™ End Tables..... | 124 |
| Utility Tables | 125 |
| Utility Tables Ordering Information | 126 |
| Utility Tables..... | 127 |
| EDUCATION | |
| Cross Reference by Application | 128-129 |
| Build™ | 130 |
| Build™ Ordering Information | 131 |
| Build™ Shape Matrix..... | 132 |
| Build™ Table Configurations..... | 133-135 |
| Build™ Table Tops..... | 136-138 |
| Build™ Tables..... | 139 |
| Build™ Nesting Tables..... | 140 |
| Build™ Accessories..... | 141 |
| Build™ Student Desk Surface Dimensions..... | 142 |

| | |
|---|---------|
| Build™ Student Desk Configurations..... | 143-144 |
| Build™ Student Desks..... | 145-146 |
| Build™ Student Desk Accessories..... | 147 |
| Build™ Makerspace Table..... | 148-150 |
| Build™ Makerspace Table Accessories..... | 151 |
| Build™ Makerspace Stools..... | 152 |
| Revel™ | 153 |
| Revel™ Stool..... | 154 |
| SmartLink® | 155 |
| SmartLink® Ordering Information | 156 |
| SmartLink® Specifying Information | 157-162 |
| SmartLink® Student Desks..... | 163 |
| SmartLink® Value Series Student Desks..... | 164 |
| SmartLink® Student Desk Accessories..... | 165 |
| SmartLink® Chairs..... | 166-169 |
| SmartLink® Teacher Stations..... | 170 |
| SmartLink® Value Teacher Stations..... | 171 |
| SmartLink® Teacher Station Accessories..... | 172 |
| SmartLink® Modular Storage..... | 173-174 |
| SmartLink® Modular Storage and Accessories..... | 175 |
| SmartLink® Wall Rail System..... | 176 |
| SmartLink® Wall Rail System Accessories..... | 177 |
| SmartLink® Value Mobile Storage..... | 178-180 |

WORKPLACE TOOLS

| | |
|---|---------|
| Workplace Tools | 181 |
| Workplace Tools Ordering Information | 182 |
| Monitor Arms..... | 183-184 |
| CPU Holders..... | 185 |
| Keyboard Trays..... | 186-187 |
| Corner Sleeves..... | 188 |
| Center Drawers..... | 189-190 |
| Coordinate™ Desktop Riser..... | 191 |
| Ergonomic Solutions..... | 192 |
| Chair Mats..... | 193 |
| Task Lights..... | 194-195 |
| Paper Management & Organizational Tools..... | 196-199 |
| Interlink IQ Electrical..... | 200-201 |
| 4-Trac Hardwire Electrical System..... | 202-203 |
| Power & Cable Management..... | 204 |
| Power..... | 205-207 |
| Power & Cable Management..... | 208 |
| Healthy Workplace Tools..... | 209-210 |

SEATING

| | |
|--|---------|
| Seating Functions | 212-213 |
| Ordering Information | 214-215 |
| Fire Code/Compliant Seating | 216 |
| Accommodate® | 217 |
| Accommodate® Options | 218 |
| Accommodate® Fabric Options | 219 |
| Accommodate®..... | 220-223 |
| Adjustable Task/Lab Stools | 224 |
| Assemble™ Nesting/Stacking Chairs | 225 |
| Astir™ Collaborative Work Seating | 226 |
| Astir™ Options | 227 |
| Astir™ Finish Options | 228 |
| Astir™ Collaborative Work Seating..... | 229-240 |
| Astir™ Power..... | 241 |

For information regarding HON registered and unregistered trademarks, please go to hon.com/protected-marks. Haworth®, Herman Miller®, Knoll®, and Steelcase® are registered trademarks of their respective owners and use of the marks do not imply affiliation or endorsement of The HON Company or its products.

LIST PRICER

Effective Date: October 2021

- All illustrations and specifications in this publication are based on the latest product information available at the time of print. For the most recent version, please go to www.hon.com.
- Software support packages furnished to the customer, either by The HON Company or by another source, which support the sale of HON products are superseded by printed price lists.
- All dimensions shown in this publication are nominal.
- Pricing is subject to change without notice.

- All orders are subject to prices in effect at the time of order.
- Ordering information appears at the beginning of a section complete with examples on how to specify. These specifying information pages are referenced at the bottom center of product pages.
- HON Full Lifetime Warranty applies unless otherwise noted.
- HON nationwide customer service:
Phone: (800) 833-3964

HON LIST PRICER

Table of Contents

| | | | | | |
|---|---------|--|---------|--|---------|
| Cambia™ 2160 Series | 242 | Ignition® | 327 | Neutralize™ | 401 |
| Cambia™ 2160 Series Options | 243 | Ignition® Options | 328-329 | Neutralize™ Mesh Chair..... | 402 |
| Cambia™ 2160 Series..... | 244 | Ignition® 2.0 Options | 330-331 | Nucleus® | 403 |
| Ceres® | 245 | Ignition® 2.0 Dimensions | 332-333 | Nucleus® Task Chair Options | 404 |
| Ceres® Task Chair Options | 246 | Ignition® 2.0..... | 334-338 | Nucleus® Multi-Purpose and Café Chair Options | 405 |
| Ceres® Multi-Purpose Chair Options | 247 | Ignition® 2.0 ReActiv®..... | 339-340 | Nucleus® Fabric Options | 406 |
| Ceres® Fabric Options | 248 | Ignition® 2.0 Upholstered..... | 341-342 | Nucleus®..... | 407-408 |
| Ceres®..... | 249-250 | Ignition® 2.0 Accessories..... | 343-344 | High-Density Olson Stacker® 4040 Series | 409 |
| Charge™ | 251 | Ignition® Multi-Purpose Chair Options | 345 | High-Density Olson Stacker® 4040 Series..... | 410 |
| Circulate™ Club/Lounge | 252 | Ignition® Multi-Purpose..... | 346 | Pagoda® | 411 |
| Client™ | 253 | Ignition® Multi-Fabric Multi-Purpose..... | 347 | Pagoda® Options | 412-413 |
| Cliq™ | 254 | Ignition® Multi-Fabric Stools..... | 348 | Pagoda® 4070 Series..... | 414-415 |
| Cliq™ Fabric Options | 255 | Ignition® Guest..... | 349 | Pagoda® 4090 Series..... | 416-417 |
| Cliq™..... | 256-257 | Ignition® Task Chair Options | 350 | Pagoda® 4070/4090 Series..... | 418 |
| Comfortask® 5900 Series | 258 | Ignition® Fabric Options | 351 | Park Avenue Collection® 5000 Series | 419 |
| Comfortask® 5900 Series Options | 259 | Ignition®..... | 352-355 | Park Avenue Collection® 5000 Series Options | 420 |
| Comfortask® 5900 Series Fabric Options | 260 | Ignition® Accessories..... | 356 | Park Avenue Collection® 5000 Series..... | 421 |
| Comfortask® 5900 Series..... | 261-262 | Instigate™ Mesh Guest Chairs | 357 | Perch™ Active Seating | 422 |
| Convergence® | 263 | Invitation® 2110 Series | 358 | Perpetual® Nesting Chairs | 423 |
| Convergence® Options | 264 | Invitation® 2110 Series Options | 359 | Perpetual® Nesting Chairs Options | 424 |
| Convergence® Fabric Options | 265 | Invitation® 2110 Series..... | 360 | Perpetual® Nesting Chairs..... | 425 |
| Convergence® Standard Task Chairs..... | 266 | Invitation® 2110 Series Connectors..... | 361 | Pillow-Soft® 2090 Series | 426 |
| Convergence® Value Task Chairs..... | 267 | Invitation® Lounge | 362 | Pillow-Soft® 2090 Series Options | 427 |
| Corral™ Contemporary Lounge | 268 | Invitation® Lounge Options | 363 | Pillow-Soft® 2090 Series..... | 428 |
| Contemporary Occasional Tables | 269 | Invitation® Lounge..... | 364 | Pillow-Soft® 2190 Series | 429 |
| Crio™ Mesh Chairs | 270 | Lota® | 365 | Pillow-Soft® 2190 Series Options | 430 |
| Define™ Executive Chairs | 271 | Lota® Options | 366 | Pillow-Soft® 2190 Series..... | 431 |
| Endorse® Collection | 272 | Lota® Fabric Options | 367 | Prominent™ Mesh Chairs | 432-433 |
| Endorse® Options | 273 | Lota®..... | 368 | Ruck™ | 434 |
| Endorse® Dimensions | 274 | Matter™ | 369 | Ruck™ Options | 435 |
| Endorse® Fabric Options | 275 | Matter™ Multi-Purpose Chairs..... | 370 | Ruck™ Laminate Seating..... | 436 |
| Endorse®..... | 276-280 | Mav™ | 371 | Ruck™ Wood Seating..... | 437 |
| Endorse® Accessories..... | 281 | Mav™ Finish Options | 372 | Ryder™ | 438 |
| Entire™ Mesh Chairs | 282 | Mav™..... | 373-377 | Ryder™ Sport Executive Chairs..... | 439 |
| Exposure™ Mesh Chairs | 283 | Merit™ | 378 | Scatter™ Guest Chairs | 440 |
| Flock® | 284 | Merit™ Executive Conference Chair..... | 379 | Skip | 441 |
| Flock® Options | 285-286 | Motivate® Chairs | 380 | Skip Collaborative Chair..... | 442 |
| Flock® Fabric Options | 287 | Motivate® Task Chair Options | 381 | Solutions Seating® 4000 Series | 443 |
| Flock® Collaborative..... | 288-292 | Motivate® Task Chair Fabric Options | 382 | Solutions Seating® 4000 Series Options | 444 |
| Flock® Multi-Fabric Collaborative..... | 293-297 | Motivate® Task Chairs..... | 383 | Solutions Seating® 4000 Series..... | 445 |
| Flock® Base Frames and Legs..... | 298 | Motivate® High-Density Sled Base Chair Options | 384 | Solve® | 446 |
| Flock® Options | 299 | Motivate® High-Density Sled Base Chairs..... | 385-386 | Solve® Options | 447-449 |
| Flock® Fabric Options | 300 | Motivate® 4-Leg Chair Options | 387 | Solve®..... | 450-456 |
| Flock® Collaborative..... | 301-303 | Motivate® 4-Leg Chair Fabric Options | 388 | Solve® Accessories..... | 457 |
| Flock® Multi-Fabric Collaborative..... | 304 | Motivate® 4-Leg Chairs..... | 389-390 | Soothe® | 458 |
| Flock® Options | 305 | Motivate® Nesting/Stacking Flex-Back Chair Options | 391 | Soothe® Options | 459-460 |
| Flock® Mini Cube and Cylinders..... | 306 | Motivate® Nesting/Stacking Flex-Back Chair Fabric Options | 392 | Soothe®..... | 461 |
| Flock® Multi-Fabric Mini Cube and Cylinder..... | 307 | Motivate® Nesting/Stacking Flex-Back Chairs..... | 393 | Soothe® Multi-Fabric..... | 463-464 |
| Gateway™ | 308 | Motivate® Chair with Tablet Arm Options | 394 | Soothe® Benches..... | 465 |
| Gateway™ Fabric Options | 309 | Motivate® Chair with Tablet Arm Fabric Options | 395 | Soothe® Tables..... | 466 |
| Gateway™ Standard Task Chair..... | 310 | Motivate® Chair with Tablet Arm..... | 396 | Soothe® Brackets..... | 467 |
| Gateway™ Value Task Chair..... | 311 | Motivate® Flex-Back Chair with Tablet Arm Options | 397 | TopFlight™ Wood Seating | 468 |
| Grove® | 312 | Motivate® Flex-Back Chair with Tablet Arm Fabric Options | 398 | Torch™ Mesh Chairs | 469 |
| Grove® Options | 313-314 | Motivate® Flex-Back Chair with Tablet Arm..... | 399 | Traction™ Executive Chairs | 470 |
| Grove® Fabric Options | 315 | Network™ | 400 | Validate™ | 471 |
| Grove®..... | 316-318 | | | ValuTask® | 472 |
| Grove® Multi-Fabric..... | 319-322 | | | Versant® Tandem | 473 |
| Grove® Accessories..... | 323 | | | Versant® Tandem Options | 474 |
| GuestStacker® 4030 Series | 324 | | | | |
| GuestStacker® 4030 Series..... | 325 | | | | |

For information regarding HON registered and unregistered trademarks, please go to hon.com/protected-marks. Haworth®, Herman Miller®, Knoll®, and Steelcase® are registered trademarks of their respective owners and use of the marks do not imply affiliation or endorsement of The HON Company or its products.

LIST PRICER

Effective Date: October 2021

- All illustrations and specifications in this publication are based on the latest product information available at the time of print. For the most recent version, please go to www.hon.com.
- Software support packages furnished to the customer, either by The HON Company or by another source, which support the sale of HON products are superseded by printed price lists.
- All dimensions shown in this publication are nominal.
- Pricing is subject to change without notice.
- All orders are subject to prices in effect at the time of order.
- Ordering information appears at the beginning of a section complete with examples on how to specify. These specifying information pages are referenced at the bottom center of product pages.
- HON Full Lifetime Warranty applies unless otherwise noted.
- HON nationwide customer service:
Phone: (800) 833-3964

HON LIST PRICER

Table of Contents

| | | | | | |
|--|-----|---|---------|--|---------|
| Versant® Tandem..... | 475 | Wave™ Mesh Chairs | 486 | Mesh Chairs | 504 |
| Versant® Tandem Laminate Occasional Tables..... | 476 | West Hill™ Casual Lounge Seating | 487 | Nesting Chairs | 505 |
| Versant® Tandem..... | 477 | West Hill™ Options | 488 | Task Chairs | 506 |
| Volt® | 478 | West Hill™ Finish Options | 489 | Workplace Tools Ergonomic Solutions | 507 |
| Volt® 5700/5710 Series Options | 479 | West Hill™ Casual Lounge Seating..... | 490-495 | Workplace Tools Chair Mats | 508 |
| Volt® 5700 Series..... | 480 | West Hill™ Ottomans..... | 496 | | |
| Volt® 5710 Series..... | 481 | West Hill™ Casual Lounge Seating | 497-498 | INDEX | |
| Volt® 5720/5730 Series Options | 482 | Throw Pillows..... | 499 | Cross Reference Index..... | 509-514 |
| Volt® 5720/5730 Series Fabric Options | 483 | West Hill™ Accessories..... | 500 | Information on Ordering Parts..... | 528 |
| Volt® 5720 Series..... | 484 | Executive Chairs | 501-502 | | |
| Volt® 5730 Series..... | 485 | Guest Chairs | 503 | | |

ADDITIONS

NEW ADDITIONS: PRODUCTS

| Tables | Effective Date |
|---|-----------------------|
| Scramble™ Models: HSCCSR2448LMK, HSCCSR2448BPG, HSCCSS36LMK, HSCCSS48LMK, HSCCSS36BPG, HSCCSS48BPG, HSCCR36LMK, HSCCR48LMK, HSCCR36BPG, HSCCR48BPG, HSCCESS24LMK, HSCCESS24BPG, HSCER24LMK, HSCER24BPG | January 1, 2021 |
| Seating | Effective Date |
| Cliq™ Model: HCLQS | July 1, 2021 |
| Ignition® Models: HIWMMHR, HIWMBT, HIWMMS, HIWMMSKD, HI2HR, HI2BTHR | July 1, 2021 |
| Fabrics and Finishes | Effective Date |
| Laminates Handspun Chestnut (LAHC), Handspun Dove (LAHD), Handspun Pearl (LAHP), Handspun Slate (LAHS) | July 1, 2021 |

DISCONTINUATIONS

| Tables | Effective Date | Workplace Tools | Effective Date |
|--|-------------------|--|------------------------------------|
| 66000 Series Models: H66591, H66581, H66571, H66551, H66531, H66541, H66597, H66582, H66577, H66557, H66537, H66547, H66280, H66282 | December 31, 2021 | Coordinate™ Models: HS1100, HS1101 Model: HS1102 | December 31, 2021 June 30, 2021 |
| Preside® Model: H94011 | December 31, 2021 | Ergonomic Solutions Model: HBEAFM1 | December 31, 2021 |
| Seating | Effective Date | Fabrics and Finishes | Effective Date |
| Accommodate® Fire Code Models: HSCS1FC, HSCS1DFFC, HSGSXFC, HSGSXDFFC, HSGS6FC, HSGS6DFFC, HSB50FC, HSB50DFFC, HSCS2FC, HSCS2DFFC | December 31, 2021 | 4-Way Stretch Mesh Chai (IH), Navy (IY) | July 1, 2021 |
| Boda™ Fire Code Models: HMH01, HMH02 | December 31, 2021 | Fabrics Clyde Weathered (CLYD09) | December 31, 2020 |
| Cambia™ Fire Code Models: H2165FC, H2164FC | December 31, 2021 | Laminates Sheer Mesh (A5) | June 30, 2022 |
| Ceres® Model: HCW1.PB | December 31, 2021 | Canyon Zephyr (K9) | June 30, 2022 |
| Ceres® Fire Code Models: HCW1FC, HCG6FC, HCG6DFFC | December 31, 2021 | Desert Zephyr (K8) | June 30, 2022 |
| ComforTask® Fire Code Models: H5905FC, H5903FC, H5902FC, H5901FC | December 31, 2021 | Shadow Zephyr (K1) | June 30, 2022 |
| Endorse® Fire Code Models: HLWUFC, HLWUBTFC, HLWMFC, HLWMBTFC, HLTUFC, HLTSUFC, HLTSPFC, HLTMFC, HLTDFC, HLTDFC, HLEUFC, HLEUBTFC | December 31, 2021 | Grey Tigris (L6) | June 30, 2022 |
| Flock® Fire Code Models: HFL450FC, HFLCC1DFFC, HFLCC1FC, HFLMC1DFFC, HFLMC1FC, HFLMC1SDFFC, HFLMC1SFC, HFLML1DFFC, HFLML1FC, HFLMR1DFFC, HFLMR1FC, HFLSC1DFFC, HFLSC1FC, HFLSC1SDFFC, HFLSC1SFC, HFLS01FC, HFLWI45DFFC, HFLWI45FC, HFLWO45DFFC, HFLWO45FC | December 31, 2021 | Whitestone (K4) | June 30, 2022 |
| Grove® Fire Code Models: HML1SDFFC, HML1SFC, HML2SDFFC, HML2SFC, HML2STDFFC, HML2STFC, HML3SDFFC, HML3SFC | December 31, 2021 | | |
| Ignition® Fire Code Model: HIGB1 | December 31, 2021 | | |
| Invitation® Fire Code Models: HFAA01FC, HFALO2FC, HFAS03FC | December 31, 2021 | | |
| Lota® Model: H2282 | December 31, 2021 | | |
| Network™ Fire Code Models: HVL281, HVL289 | December 31, 2021 | | |
| Nucleus® Fire Code Models: HN7FC, HN6FC, HNIUFC, HNIFC | December 31, 2021 | | |
| Pagoda® Fire Code Models: H4099FC, H4097FC, H4095FC, H4093FC, H4091FC, H4079FC, H4077FC, H4075FC, H4073FC, H4071FC | December 31, 2021 | | |
| Park Avenue Seating® Fire Code Models: H5001FC, H5002FC | December 31, 2021 | | |
| Perpetual® Fire Code Models: HPN2FC, HPN1FC | December 31, 2021 | | |
| Pillow-Soft® 2090 Series Fire Code Models: H2093FC, H2092FC, H2091FC | December 31, 2021 | | |
| Pillow-Soft® 2190 Series Fire Code Models: H2194FC, H2192FC, H2191FC | December 31, 2021 | | |
| Solutions Seating® Fire Code Models: H4008FC, H4003FC, H4002FC, H4001FC | December 31, 2021 | | |
| Solve® Fire Code Models: HSLVSMMSFC, HSLVTMMSFC, HSLVTMMFC, HSLVSMFC | December 31, 2021 | | |
| Soothe® Fire Code Models: HHCPIFC, HHCP1DFFC, HHCGB31FC, HHCGB21FC, HHCGB50FC, HHCGB50DFFC, HHCGB21FC, HHCGB21DFFC, HHCGB11FC, HHCGB11DFFC | December 31, 2021 | | |
| Tilt™ Model: HVL951 | December 31, 2021 | | |
| Traction™ Models: HVL103.SB06, HVL103.SB42 | December 31, 2021 | | |
| Versant® Fire Code Models: HHB02FC, HHB03FC, HHCBS0FC, HHCT01FC, HHCT02FC, HHCT12FC | December 31, 2021 | | |

HON FULL LIFETIME WARRANTY INFORMATION



FULL LIFETIME WARRANTY

YOUR HON FULL LIFETIME WARRANTY

Every time you purchase a HON product, you're making an investment in your future. We're proud to play a part in that future, and you can trust us to do our best for as long as you need us.

The HON Full Lifetime Warranty is our assurance to you that the HON desks, workstations, seating, tables, or storage you purchase will be free from defective material or workmanship for the life of the product.

In the unlikely event that any HON product or component covered by the HON Full Lifetime Warranty should fail under normal workplace use as a result of defective material or workmanship, HON shall repair or replace with comparable product (at HON's discretion), free of charge.

WHAT'S COVERED BY THE HON FULL LIFETIME WARRANTY?

Your HON Full Lifetime Warranty applies to product manufactured after January 1, 2011. All HON product lines, materials, and components are covered by the HON Full Lifetime Warranty except for the items described below.

The specific product lines, materials, and components listed below are covered under HON's Full 12-Year, Full 10-Year, and Full 5-Year Warranties (from date of purchase).

HON'S FULL 12-YEAR WARRANTY

- Electrical components (lamps and ballasts are not covered)
- 4-Way Stretch Mesh
- Seating controls
- Pneumatic Cylinders
- Wood Seating
- Accessories
- Laminate Surfaces

HON'S FULL 10-YEAR WARRANTY

- Coordinate™ Height Adjustable Bases (HHATB)

HON'S FULL 7-YEAR WARRANTY

- Coordinate™ Legacy Bases (HHAB and HREC)
- Workwall Markerboard Glass Tiles

HON'S FULL 5-YEAR WARRANTY

- All LED task lights
- Panel and seating textiles
- Coordinate™ ETA Height Adjustable Base (HHABETA2S2L)
- Coze™
- Between™ Multi-Purpose Table
- Acoustic Solutions by Unika Vaev
- Mod

HON'S FULL 1-YEAR WARRANTY

- Healthy Workplace Tools & Acrylic Screens

These warranties apply to HON products sold within the United States of America, U.S. Territories, and Canada, as well as U.S. Military and Federal Agency purchases (regardless of location).

IS ANYTHING NOT COVERED?

There are a few exclusions to the HON Full Lifetime Warranty and to the 12-, 10-, and 5-year warranties. These exclusions are:

- All HON products that are covered under a separate 5-year warranty.
- Color-fastness or matching of colors, woodgrains, or textures occurring in wood, leather, or other materials that naturally exhibit inherent color variations.
- Customer's own materials (COM) selected by and used at the request of the user.
- Modifications or attachments to the product that are not approved by The HON Company and product failures resulting from such modifications or attachments.
- Product normal wear and tear, which are to be expected over the course of ownership.
- Products that were not installed, used, or maintained in accordance with product instructions and warnings.
- Products used for rental purposes.
- Damage caused by cleaning chemicals.
- Dye transfer caused by external contaminants (including clothing and accessory dyes such as those used on denim jeans) may migrate to lighter colors. This phenomenon is increased by humidity and temperature and is irreversible.
- Fabric pattern match seat to back or chair to chair. If pattern match is needed, please submit a Tailored Solutions request or contact HON Customer Support/Tailored Solutions with questions.

WARRANTY REQUESTS OR QUESTIONS?

Your HON Dealer is our mutual partner in supporting your warranty requests. To obtain service under this warranty, please contact your HON dealer. If you are not sure who your dealer is, please call HON Customer Support at 800.833.3964.

THAT'S YOUR HON FULL LIFETIME WARRANTY AS AN OWNER OF HON PRODUCT, THE WARRANTY EXPLAINED HERE IS YOUR SOLE AND EXCLUSIVE REMEDY. THERE ARE SOME EXCEPTIONS IF YOU PURCHASED THE PRODUCT FOR HOME OR PERSONAL USE WHICH ARE EXPLAINED BELOW. TO THE EXTENT ALLOWED BY LAW, THE HON COMPANY MAKES NO OTHER WARRANTY, EITHER EXPRESS OR IMPLIED, INCLUDING ANY WARRANTY OF MERCHANTABILITY OR FITNESS FOR A PARTICULAR PURPOSE. THE HON COMPANY WILL NOT BE LIABLE FOR ANY CONSEQUENTIAL OR INCIDENTAL DAMAGES.

A WORD ABOUT PURCHASES FOR HOME OR PERSONAL USE

Please note, this section only applies if you purchased your HON product for your home or for your own personal or family use. HON's warranties give you specific legal rights and you may have other rights, which vary from state to state. As a consumer purchaser, the complete exclusion of implied warranties noted in the above paragraph does not apply to you, however, to the extent allowed by applicable state law, the implied warranties are limited to the applicable term of the warranty. Some states do not allow the exclusion or limitation of incidental or consequential damages, so the above exclusion or limitation may not apply to you.

HON LIMITED 5-YEAR WARRANTY INFORMATION



LIMITED 5-YEAR WARRANTY

The HON Company promises to repair or replace HON products or components covered under this warranty that are found to be defective in material or workmanship within five (5) years from the date of original purchase so long as you, the original purchaser, still owns it. This is your sole and exclusive remedy. This warranty is subject to the provisions below. It applies to the products listed here manufactured after January 1, 2018.

LIMITATIONS:

- Upholstery on chairs is warranted for two years from date of purchase.
- Damage caused by the carrier in-transit is handled under separate terms.

EXCLUSIONS:

This warranty does not apply and no other warranty applies to:

- Normal wear and tear, which are to be expected over the course of ownership.
- Modifications or attachments to the product that are not approved by The HON Company.
- Products that were not installed, used or maintained in accordance with product instructions and warnings.
- Products used for rental purposes.

SEATING USAGE

Normal commercial use for seating is identified as the equivalent of a single shift, forty-(40) hour workweek. To the extent that a seating product is used in a manner exceeding this, the applicable warranty period will be reduced in a pro-rata manner.

A WORD ABOUT COLOR VARIATIONS, FABRICS AND FINISHES:

The HON Company does not warrant the color-fastness or matching of colors, grains or textures of covering materials.

CUSTOMER'S OWN MATERIAL (COM)

Not available on HON products covered under the HON 5-year warranty.

TO THE EXTENT ALLOWED BY LAW, THE HON COMPANY MAKES NO OTHER WARRANTY, EITHER EXPRESS OR IMPLIED, INCLUDING ANY WARRANTY OF MERCHANTABILITY OR FITNESS FOR A PARTICULAR PURPOSE. THE HON COMPANY WILL NOT BE LIABLE FOR ANY CONSEQUENTIAL OR INCIDENTAL DAMAGES.

NOTICE TO PURCHASERS FOR HOME OR PERSONAL USE:

Federal law does not permit the exclusion of certain implied warranties for consumer products. Therefore, if you are purchasing this product for home or personal use, the exclusion of implied warranties noted in the above paragraph does not apply to you. Some states do not allow the exclusion or limitation of incidental or consequential damages, so the above limitation or exclusion may not apply to you. This warranty gives you specific legal rights, and you may also have other rights which vary from state to state.

This warranty applies only to products sold within the United States of America and the Commonwealth of Canada.

TO OBTAIN SERVICE UNDER THIS WARRANTY:

Your HON® Dealer is our mutual partner in supporting your warranty requests. By following the procedures outlined below, you can be assured of the best level of service. Please note: Consent of The HON Company must be obtained before any warranty work is performed. To obtain consent, please take the following steps:

1. Contact the Dealer from whom the product was purchased within 30 days of discovery of the defect. Be prepared to affirm that you are the original purchaser of the product and to provide the serial number(s) from the product in question.
2. Your Dealer will gather all pertinent information regarding the claim, inspect the product and contact a HON Company customer service representative. (Please allow a reasonable amount of time for inspection and review.)
3. If The HON Company affirms that the product in question is eligible under the conditions of the warranty as stated above, the customer service representative or another representative of the Company will determine whether to provide replacement parts, authorize repairs or replace the product.

ORDERING INFORMATION

ORDERING

Electronic ordering is the standard order process for HON. HON supports the following primary methods for the electronic transmission of orders and order related documents:

Electronic Ordering

Available in the HONReady portal at honready.hon.com. There are multiple options available for processing orders electronically.

Integration with the standard Office Furniture business systems or other pre-approved proprietary software packages.

SIF file upload using fully optioned SIF files into the electronic ordering applications.

Manual entry of line items into the electronic ordering application.

EDI-System to System Integration

With standard Office Product systems or other pre-approved proprietary software systems.

Training, technical set-up and support is available through our Dealer Operations Team at honready@honcompany.com.

ORDER REQUIREMENTS

- Customer must provide complete and correct information, including complete model number, finishes, colors, options, and quantity.
- If a bid quotation or other special pricing applies, such information must be clearly stated on the order with applicable bid number or contract number.
- Order Management contact name and phone number.
- Delivery Appointment contact name and phone number at the dealership or installation company. HON does not accept orders with end user appointment contacts.
- Dealer Sales Representative, primary or multiple DSRs.
- “Best Date Available” for the entire order is standard service for HON. If eligible, other Date Requests may be requested and must be submitted with the order. Other Date Requests are subject to review by HON prior to acceptance:
 - “Ship After” requests are eligible on all order sizes
 - “Deliver On” requests are eligible for full truckload orders
- Additional services outside of HON’s standard services may be available through HON’s ‘Enhanced Services’ for a corresponding fee. Requested services from ‘Enhanced Services’ must be provided at time of order placement.
- The Company reserves the right to require electronic orders or charge \$50 fee per Purchase Order (PO) for manual order processing.
- Failure to provide complete and accurate information results in delayed order entry and acknowledgment. Incomplete orders will not be produced and will be returned to Dealer for correction.

ACKNOWLEDGMENT SERVICE

- E-mailed acknowledgments are available by customer request.
- An acknowledgment will be emailed the morning of the next business day, unless order is placed on credit or other order hold.
- The order will not receive an acknowledged shipment date until all order holds are released.

ORDER CHANGES OR CANCELLATIONS

For Order Changes or Cancellations, please contact Customer Support at 800-833-3964.

TERMS AND CONDITIONS

See **HON NOW** on honready.hon.com for more information about HON NOW delivery, services and ordering information.

INTEGRATED DESIGN SOLUTIONS

HON INTEGRATED DESIGN SOLUTIONS

Need design assistance? We can help! Our expert design staff will create a professional design package that is sure to put you one step ahead of the competition. And the best part is – it's free!

AUDIT

We will check your drawing and parts list for accuracy. We verify quantity, specification accuracy, product compatibility and structural support.

PLAN & SPECIFY

We will provide a professional design package including a CAD furniture plan, 3-D line drawing and complete parts list based on the rough sketch and work order forms you supply.

VALUE ENGINEERING

We will optimize workstation layouts and propose potential cost saving measures to help your customer save money and make you more competitive and profitable.

RENDERING

We will create a photo realistic rendering of your furniture plan to help your customer visualize what their desired office space will look like.

*SPACE PLANNING (BILLABLE SERVICE)

Let our team do the creative work for you. Our low rates and expert staff will create a furniture layout and design that best suits your customer.

PLANNING TYPICALS

Quick planning ideas to share with your clients. Various settings showcasing desks, tables and workstations available in multiple formats. View them today under Design Resources on the HON Ready Portal.

CONTACT INTEGRATED DESIGN SOLUTIONS

Questions? Please reach out to your region's dedicated designer. Not sure how to reach your designer? Send us a note at the email below.

E-Mail: integrateddesign@honcompany.com



Solve® Chair shown with Coordinate™ Height Adjustable Table.

Project Space

A place for all HON Project Services

Project Space provides one platform to access the full portfolio of HON services including:

- Plan & Specify
- Audit
- Product Modification
- Special Laminates
- Value Engineering
- Rendering
- Customer's Own Material
- Dual Fabric Applications
- Space Planning
- Special Paints
- Project Bid Pricing

Submit your request on the Community powered by HNI, Projects.

Project Space Lead Time: 1-3 business days depending on complexity and size of your project.

TAILORED SOLUTIONS ORDERING INFORMATION

PRODUCT MODIFICATIONS

Modifications include structural and dimensional modifications to existing product and Dual Fabric Applications, when standard model is not available.

The HON Company, at its own discretion, may modify standard products to meet specific needs. Product specials can be requested on HON brand product only.

List prices contained in published list pricers are for standard catalog items only. Changes or alterations to catalog items other than those listed as catalog options are subject to additional charges. Pricing will only be furnished upon approval of the special request.

Requests to have the product produced in more than one fabric (e.g., fabric on the seat is different than the fabric on the back), are considered a Dual Fabric Applications request and follow the Product Modification request process within MyProjects.

SPECIAL LAMINATES

Special laminates include requests for laminates not available as part of The HON Company's standard offering. Requests for special laminates are subject to manufacturing approval and minimum order quantities. The HON Company approved special laminates will be subject to a designated upcharge per unit.

Requests for special laminates should be submitted through the MyProjects Application on the HON Ready portal. Pricing will only be furnished upon approval of the special request.

SPECIAL PAINTS

- The HON Company's paint matching equipment can match almost any color, excluding some metallic and whites.
- Special paint requests must be submitted on the HON Ready Portal MyProjects application.
- In order to request a paint sample, the customer must have a minimum order of 10 like product units. Any requests with less than that amount will not be processed.
 - For each new paint request, there will be a \$500 net charge. A sample of the exact color desired is required for matching and approval. The HON Company will match the color and provide a production sample for the customer to review and approve.

- Once the signed paint sample is received at The HON Company, the request will be approved.
- Each unique color or finish combination incurs a designated upcharge per color per order (all standard discounts/competitive project pricing applies).

Special note: Some special colors could fall outside of this program due to production costs or not meeting The HON Company's quality standards. The HON Company may apply additional charges to some colors which are costly to apply, and refuse some orders on colors that cannot meet The HON Company's high-quality standards. The HON Company will notify the customer upon completion of The HON Company's evaluation if a change in price is required or rejection of the order.

DISCONTINUED PRODUCT

Requests for discontinued product require engineering evaluation, safety review, and testing to current standards prior to approval. Many discontinued products are not available for order. Requests for discontinued products should be submitted through the MyProjects Application on the HON Ready portal.

LEAD TIMES FOR SPECIALS PRODUCT

Lead times on orders containing specials are subject to production capacity and material availability. When possible, the customer should order special products separately to avoid extended lead times for standard products. Extended lead times will be noted on the specials request.

CHANGES TO SPECIALS PRODUCT

A special model will be provided for each approved special item to process orders. Once an order is placed, no changes or cancellations can be made to the order without approval from Tailored Solutions.

CONTACT TAILORED SOLUTIONS

Phone: 800.833.3964 and listen for Tailored Solutions offering on the menu.

Email: HONSpecials@honcompany.com

CUSTOMER'S OWN MATERIAL ORDERING INFORMATION

CUSTOMER'S OWN MATERIAL (COM) PROGRAM

Customer's Own Material (COM) is a request to use fabrics not available as part of HON's standard fabric offering. Manufacture to Supply (MTS) and Dealer to Supply (DTS) are the two ordering methods. The HON Company has partnered with fabric manufacturers to provide competitive pricing and selection through the MTS program. MTS will be the standard offering unless The HON Company is unable to procure the fabric. If there is a DTS request submitted, The HON Company will advise at the time of the request if DTS is available.

CUSTOMER WARRANTY EXCLUSION

The HON Company shall have no responsibility for the condition, quality, value, performance, physical properties, or any other aspects of the COM.

The HON Company shall have no liability for any damages, injuries, or losses to the customer or to any third party that shall be caused by any COM or product modification, and the customer shall hold The HON Company harmless for all liability.

The HON Company assumes no responsibility for the overall appearance, flammability, normal durability, colorfastness, or any other quality of the COM or product modification after its application on a HON product beyond normal quality standards. The HON Company reserves the right to reject a COM fabric if the quality of the COM is not satisfactory for the product. Should this occur, the customer will be notified with an explanation of the issue.

The HON Company is not responsible for fabric that has become obsolete at the COM supplier, that is of poor quality, or that is delivered late to The HON Company from the COM supplier. The HON Company is not responsible for excess yardage created by DTS orders and reserves the right to dispose of the excess fabric.

As a standard HON does not pattern match any standard, partnership or COM fabric, therefore pattern match is not applicable under warranty. If pattern match is needed please submit a Tailored Solutions request or contact HON Customer Support/Tailored Solutions once your COM has been approved.

COM TESTING

As a result of recent legal requirements, The HON Company will need to obtain specific information from the fabric supplier about treatments and chemicals used in the fabric. To the extent the supplier is unwilling or unable to provide the necessary information, which could extend the testing lead time of the request.

To check if a COM has been tested previously, utilize the COM Search Tool on the HON Ready Portal > Design Resources > Textiles & Finishes section using the following information:

- COM Supplier's Name
- Fabric Pattern Name
- Color Name
- If the COM fabric has been tested and previously approved, the COM will not need to be re-tested unless testing standards have changed, fabric is to be used on a different series, or direction of the fabric has changed from what was previously approved. Please note that Panel product must be approved for each model and color.
- If the pattern has previously been tested and approved, but not in the specific requested color, the customer will need to request an order code for that color only. No further testing will be necessary since the pattern has already been approved.

If the fabric has not previously been tested, the customer must enter the COM request on the HON Ready Portal > Textiles & Finishes > COM Search Tool.

Complete the Supplier Name, Pattern, and Color drop-down fields. For quicker results in these fields, type the first letter of the (supplier, pattern, color) name and, when done, click Add and then Submit. (Multiple series can be added to the same request if they are the same supplier, pattern, and color.)

An email will be sent to the requestor stating the COM Request was successfully submitted. Up to four emails could be received: submitted, in testing, testing materials requested, and final approval/denial with price grade and fabric code. The testing process takes approximately 48 hours.

COM yardage in the pricer is shown as pattern cut only.

COM TESTING — FLAMMABILITY TESTING INFORMATION

The customer is responsible for ensuring that the COM fabric is certified to meet all flame-retardant requirements. All COM seating fabric must, at minimum, meet CAL 117 requirements. If the customer requires the chair be tested to meet the fire safety standards of CAL 133, additional testing and information is required.

MTS COM

As previously mentioned, MTS is the primary COM method.

If the COM fabric has not been tested, a COM request must be submitted on the HON Ready Portal.

For MTS orders, The HON Company will procure fabric needed for production. Should The HON Company not be able to obtain fabric yardage, the customer will be contacted.

CUSTOMER'S OWN MATERIAL ORDERING INFORMATION

When testing has been completed, the customer will be notified by the COM team of the test results. If the COM is approved, The HON Company will provide a COM tracking order code for MTS. That tracking code is required on the order in place of the standard fabric code.

If approved, MTS product will be assigned an appropriate fabric grade for pricing. The pricing can be found on the HON Ready Portal > Design Resources > Textiles & Finishes. (All standard discounts/competitive project pricing applies).

Written COM price quotes are valid for 90 days after the issue date.

DTS COM

DTS COM is only available if the COM fabric cannot be procured by The HON Company. If the fabric can be procured by The HON Company, the customer will be contacted to switch to MTS or cancel the request.

If your fabric is not listed as approved, and it is not a Partnership fabric you may request a "Dealer to Supply" code. Select the "Request COM Test" link on the COM Search website. Complete the Supplier Name, Pattern, and Color drop-down fields. For quicker results in these fields, type the first letter of the (supplier, pattern, color) name and, when done, click Add and then Submit. (Multiple series can be added to the same request if they are the same supplier, pattern, and color.)

An email will be sent to the requestor stating the COM Request was successfully submitted. Up to four emails could be received: submitted, in testing, testing materials requested, and final approval/denial with price grade and fabric code. It's rare actual test yardage is required. Testing is mainly done by reviewing the attributes of the fabric. The testing process takes approximately 48 hours.

If the COM has not been tested, a COM request must be submitted on the HON Ready Portal > Design Resources > Textiles & Finishes.

When testing has been completed, the customer will be notified by the COM team of the test results. If the COM is approved, The HON Company will provide a COM tracking order code. That tracking code is required on the order in the place of the standard fabric code.

DTS product is priced at the following grades (all standard discounts/competitive project pricing applies):

- Chairs are a Grade 4
- Panel product is a Grade D

Written COM price quotes are valid for 90 days after the issue date.

COM LEAD TIME

Ship dates will be based on fabric receipt and The HON Company's standard lead time. All fabric must be properly tagged and shipped to the appropriate producing location (provided in the approval email).

- Specific to DTS orders, COM orders will not receive a ship (acknowledged) date until The HON Company has the fabric in its possession for production.
- Specific to DTS orders, the customer may send the required yardage for the order to the address listed on the approval email to arrive no sooner than 4 weeks in advance of the acknowledgment date.

HON will make every effort to locate mis-directed COM shipments on behalf of the customer. However, The HON Company will not be responsible for any COM received without a tracking number or incorrectly shipped by the fabric vendor to an incorrect producing facility.

COM ORDERING INFORMATION

The following information must appear on or accompany the product purchase order:

- Approval tracking number and the customer's purchase order number
- COM supplier, pattern, and color name/number

The packing list for the COM must include the following information when The HON Company receives the shipment for production:

- Dealer or Wholesaler Name
- Purchase order number submitted to The HON Company
- Fabric name
- Yardage shipped
- Approval ordering code

If The HON Company receives fabric with incorrect labeling that cannot be linked to an order, The HON Company will hold the fabric for up to 7 days while the COM team attempts to identify the order. After 7 days, The HON Company will return the fabric to the sender.

Specific to DTS orders; the customer should send only the amount needed for the order. Excess yardage will be disposed of at The HON Company's discretion.

CHANGES TO COM PRODUCT

Once a COM product is ordered, no changes or cancellations can be made to the COM product without approval from the HON COM team.

CONTACT COM TEAM

Phone: 800.833.3964 and listen for COM TEAM offering on the menu.

COM Email: HONCOMTeam@honcompany.com

PARTNERSHIP TEXTILE INFORMATION

Partnership Textiles is the result of The HON Company's partnership with textile industry leaders Camira, HBF Textiles, Maharam, Stinson, and Ultrafabrics, LLC. The extensive collection of design-driven textiles create a superior offering at a great value. Partnership Textiles significantly updates HON's offering, expanding it with fresh and exciting options.

- **Fabric Warranty:** Partnership Textiles are covered by HON's Full Lifetime Warranty.
- **Lead Times:** Orders specified with Partnership Textiles will be acknowledged based on the supplier's availability and delivery schedule.
- **Availability:** The HON Company will regularly introduce new Partnership Textiles and reserves the right to change the offering at any time.
- **Fabric Cards:** A curated set of Partnership Textiles are carded jointly by HON and the supplier.

Camira

- Blazer

HBF Textiles*

- Everyday Textures

*HBF Textiles patterns are graded in to HON's offering.

Maharam

- Apt
- Bluff
- Collection 1
- Lariat
- Meld
- 6M

Stinson

- Edge
- Elevate
- Flow II
- Reliance IV

Ultrafabrics, LLC

- Brisa
- Ultraleather Pro

Fabric Memo Samples: Please contact the supplier directly:

Camira: memos@camirafabrics.com

HBF Textiles: Phone: +1 (877) 494-5727, orders@hbftextiles.com

Maharam: (800) 645-3943

Stinson: (800) 841-6279

Ultrafabrics: (877) 309-6648

HON BRANDED, PARTNERSHIP AND COM PATTERN MATCH

- Pattern matching provides alignment of patterns or stripes across individual chair surfaces. Additional yardage may be required depending on pattern repeat. If Pattern Match is needed, please contact HON Customer Support/Tailored Solutions.
- Chair to Chair Pattern Match provides identical pattern alignment from unit to unit and is available with an upcharge. Chair to Chair Pattern Match is reviewed on a case by case basis as several factors are reviewed to determine additional yardage required, including repeat and pattern direction. If Chair to Chair Pattern Match is needed, please contact HON Customer Support/Tailored Solutions.



PAINT PROGRAM

The HON Company has established paint grades to allow customers flexibility and ease in doing business with HON. HON has three paint grades P1, P2, and P3.

P1 PAINT COLORS

HON has established P1 paints which are available on a majority of core products.

P2 PAINT COLORS

Please see individual pricer pages for eligible series and upcharges for P2 paints. P2 paints are listed in the pricer pages under the column P2. Upcharges vary by product (all standard discounts/competitive project pricing applies). No minimum quantity required.

P3 PAINT COLORS

Please see individual pricer pages for eligible series and upcharges for P3 paints. P3 paints are listed in the pricer pages under the column P3. Upcharges vary by product (all standard discounts/competitive project pricing applies). No minimum quantity required.

SPECIAL PAINT COLORS (P4-P6)

With The HON Company's state of the art color matching equipment just about any color can be matched, excluding some metallic and whites. A sample of the exact color desired is required for matching and approval.

- For each newly requested paint, a net fee of \$500 will be charged to cover costs associated with the matching process.
- For existing, previously matched paints, there is no matching fee, however there is a \$100 net fee for sample panels required for the approval process. Refer to MyProjects on the HON Portal for a list of approved special paints.

For all special paint requests, HON will send a production sample for the customer to review and approve. Once the signed paint sample is received at HON the order can be entered. Upcharges vary by product (all standard discounts/competitive project pricing applies). A quantity of 10 like-model minimum order is required for special paints. For complete program details, access Tailored Solutions on the HON Ready Portal at honready.hon.com.

Some special colors could fall outside of this program due to production costs or not meeting HON quality standards. The HON Company may apply additional charges to some colors which are costly to apply, and deny some orders on colors that cannot meet our high-quality standards. We will notify the customer upon completion of our evaluation if a change in price is required or if the request is denied.

ENVIRONMENTAL STATEMENT

We continually reevaluate our purpose and processes, from fostering transparency and circularity in our supply chain to empowering our members to do and be better. We do it so the environments you create will be safer, more socially responsible, and more sustainable.

We've pursued product certifications to help communicate our commitment to developing sustainable products.

Clearing the air.

In 2006, The HON Company became one of the first office furniture manufacturer to have products certified under the Indoor Advantage™ program. Virtually all manufactured products emit chemical compounds into the air. Indoor Advantage™ certification helps assure customers that certified products will help improve the air quality within their offices and workspaces.

Developed by SCS Global Services, Indoor Advantage™ evaluates products against indoor air quality standards, like ANSI/BIFMA Furniture Emissions Standard, X7.1 and CDPH. The ANSI/BIFMA X7.1 standard allows manufacturers to test individual components, as well as complete products for emissions from volatile organic compounds (VOCs). This allows us to identify problematic materials and phase them out of our products.

Indoor Advantage™ certified products meet the LEED and WELL criteria for low-emitting materials.

Indoor Advantage™ offers two levels of certification, including Indoor Advantage™ and Indoor Advantage™ Gold.



On the LEVEL®.

LEVEL®, the certification program for the BIFMA e3 Sustainability Standard, was developed in response to increasing demand for proof that manufacturers were living up to their environmental claims. LEVEL® is a multi-attribute sustainability certification label for products that have met criteria in four categories of impact: Materials, Energy and Atmosphere, Human and Ecosystem Health, and Social Responsibility.

HON's products are certified to LEVEL 2 and LEVEL 3, the highest achievement.



Evaluating Our Impacts.

HON has begun studying the impacts our products have on the environment through lifecycle assessments and creating Environmental Product Declarations (EPDs). EPDs provide an understandable report of how a product impacts natural resources, the environment, and the atmosphere throughout its lifecycle.

Products that meet these specifications are identified throughout this publication with the following icons:

Certified SCS Indoor Advantage™

LEVEL® certified to the BIFMA e3 Sustainability Standard

Environmental Product Declarations

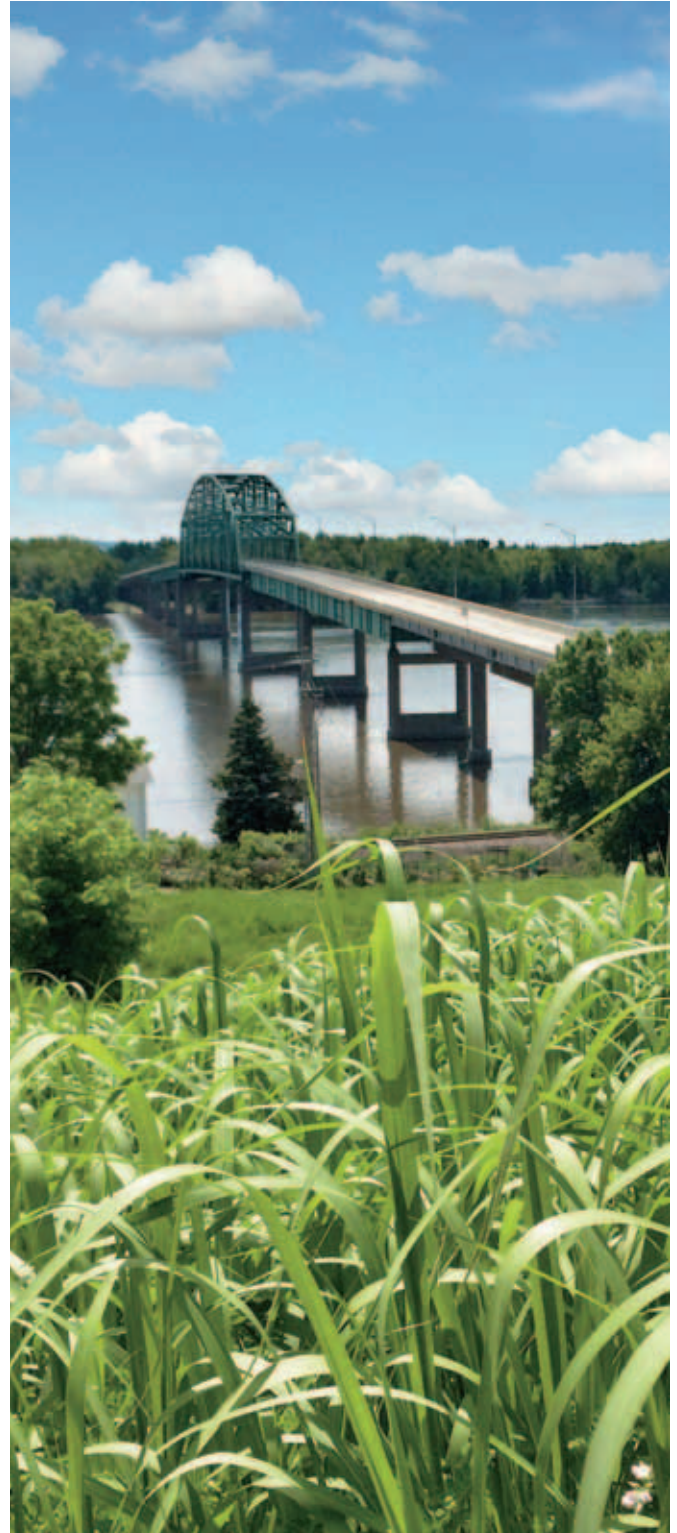

IMPORTANT INFORMATION

HON NOW™

SUPERIOR OFFICE SOLUTIONS AT THE SPEED YOU NEED

To keep your business at peak productivity, waiting is not always an option. The HON NOW™ Quickship program was designed for movers and shakers like you who want exceptional quality, durability, and versatility without compromising valuable time. Whether you're outfitting a brand new workspace or simply expanding the one you already have, we've got a variety of dependable and supportive office furniture solutions designed to fit your needs and your schedule — in a hurry, without the hassle.

To learn more, visit hon.to/now.

GSA CONTRACT INFORMATION

Model numbers identified with the verbiage “**Open Market**” are not offered on HON's GSA contract GS-27F-0015S. Model numbers identified with the following verbiage “Must be purchased with a configurable end product. If ordered separately, not on GSA contract” is to mean that these configurable components or options:

- Have no functionality or capability without being integrated into an end product, and
- Are not separately orderable; an eligible Schedule ordering activity may only purchase them with a configured system that is on contract.

HON CUSTOMER SUPPORT CONTACT INFORMATION

Nationwide CS Phone – (800) 833-3964

Nationwide CS Email – HONTeamBox@honcompany.com

Nationwide Order Entry – email: HONOE@honcompany.com

Government CS Phone – (800) 466-8694

GSA Team: HONGSATEAM@honcompany.com

GSA Order Entry: HONGSAOE@honcompany.com

Integrated Design Solutions – integrateddesign@honcompany.com

Online Order and Tool Support – HONReady@honcompany.com

DASH (transportation and delivery assistance) – (800) 334-8057

HON Literature Fulfillment Phone – (800) 466-4808



Nationwide CS Phone

800-833-3964

THE FOLLOWING ICONS MAY BE USED THROUGHOUT THIS PUBLICATION

| | | | |
|---|---|---|---|
|  | Meets or exceeds ANSI/BIFMA and ISTA performance standards |  | Readily Available. For additional lead time information see page 19. |
|  | Certified SCS Indoor Advantage™ See page 15 for more details. |  | Available within a “standard” or “extended” lead time. For additional lead time information see page 19. |
|  | Complies to the BIFMA e3 Sustainability Standard. See page 15 for more details. |  | May have extended lead times. For additional lead time information see page 19. |
|  | Caution |  | Product shipped two to a carton |
|  | Easy to assemble |  | Product shipped four to a carton |
|  | Shippable by small-package carrier |  | Fire Code |
|  | Wheel-chair compatible |  | Core Product Line |
|  | Soft-tread caster option available |  | ColorCorrect® Eligible Product |
|  | HON “One Key” Interchangeable core removable locks (see the Accessories section in the 2021 Workspaces Pricer). |  | Product scheduled for discontinuation |
|  | Omit core removable lock option available. Allows keyed alike workstations (see the Accessories section in the 2021 Workspaces Pricer). |  | DE-EMPHASIZED: Product or fabric/surface material is de-emphasized, effective date as noted. Not carded. View online at honready.hon.com |
|  | Base models available on the HON NOW Quickship Program with select options and finishes. View the entire NOW collection at honready.hon.com . |  | Warranted for multiple shift use, 24 hours a day 7 days a week |

FABRIC PATTERNS & CODES



FABRIC PATTERNS & CODES

- For additional HON to Supply COM fabric grade pricing, go to honready.hon.com and search on the HON to Supply COM link.
 - All specifications in this publication are based on the latest product information available at the time of print.
 - Certain dyes (including clothing and accessory dyes such as those used on denim jeans) may migrate to lighter colors. This phenomenon is increased by humidity and temperature and is irreversible. The HON Company LLC does not assume responsibility for dye transfer caused by external contaminants.
 - COM Ordering Information and pricing on page 12.
 - See page 13 for Partnership Textile program information.
 - All standard fabrics are carded. Cards are available through HON Literature Fulfillment.
 - Fabrics and foam meet requirements for CAL-TB 117-2013.
- ! Different fabrics and finishes have different recommended cleaning and maintenance methods. For the correct product care for all finishes view the HON Product Care guide at hon.com/customer-support/product-care.

LEAD TIMES

THE FOLLOWING ICONS ARE USED TO DENOTE FABRIC OPTION LEAD TIMES

FABRIC/FINISH LEAD TIME INDICATOR



Fabric is readily available. Products using these fabrics will receive the best available product lead time and are a good option for standards programs as they will be in the HON portfolio for several years. Go to honready.hon.com and use **Compass** for product lead times by series.



Fabric is available within standard lead times. Products using these fabrics will receive a “standard” or “extended” lead time. The lead time will be determined by the combination of product and fabric. Go to honready.hon.com and use **Compass** for product lead times by series.



Fabric may have extended lead times. Products using these fabrics will typically have a 4+ week lead time. Go to honready.hon.com and use the **Compass** tool for product lead times by series.

HON EXPRESS QUICK SHIP PROGRAM

For the full list of products delivered in 5 business days or less, visit honready.hon.com.

PRODUCT LEAD TIMES

Standard lead times for products are between 2-4 weeks. For current exceptions to our standard lead time, go to honready.hon.com and use the **Compass** tool.

In order to establish accurate expectations for your project, please review this listing prior to submitting your purchase order.

Lead time calculation begins when order is free from any holds (i.e., bad lines, material, credit, etc.).

Please note, these production lead time estimates do NOT include delivery time. All published lead times are estimates, not guarantees of delivery.

For further information concerning lead times, please contact HON Customer Support via email HONTeamBox@honcompany or by phone at **800-833-3964**.

FABRIC PATTERNS & CODES

GRADE 1

| APEX | APX |
|--------------|-------|
| ◆ Basalt | APX25 |
| ◆ Beet | APX12 |
| ◆ Blackberry | APX20 |
| ◆ Chive | APX05 |
| ◆ Iris | APX03 |
| ◆ Kiwi | APX06 |
| ◆ Lemonade | APX08 |
| ◆ Navy | APX13 |
| ◆ Papaya | APX09 |
| ◆ Pumice | APX23 |
| ◆ Rain | APX19 |
| ◆ Resort | APX15 |
| ◆ Royal | APX14 |
| ◆ Tiki | APX29 |
| ◆ Tomato | APX11 |

| ATTIRE | AI |
|-----------------|------|
| ◆ Blaze * | AI42 |
| ◆ Blue Lagoon * | AI90 |
| ◆ Crimson * | AI62 |
| ◆ Fatigue * | AI76 |
| ◆ Ivy * | AI82 |
| ◆ Lithium * | AI19 |
| ◆ Onyx * | AI10 |
| ◆ Sable * | AI49 |
| ◆ Taupe * | AI26 |
| ◆ Turquoise * | AI96 |

| BLACK FABRIC | ACCF |
|--------------|--------|
| ◆ Black | ACCF10 |

| BLACK MESH | ACCM |
|------------|--------|
| ◆ Black | ACCM10 |

| CENTURION | CU |
|-------------|------|
| ◆ Apricot | CU47 |
| ◆ Bark | CU25 |
| ◆ Black | CU10 |
| ◆ Espresso | CU49 |
| ◆ Fog | CU03 |
| ◆ Frost | CU22 |
| ◆ Goldenrod | CU27 |
| ◆ Indigo | CU06 |
| ◆ Iris | CU50 |
| ◆ Iron Ore | CU19 |
| ◆ Jade | CU83 |
| ◆ Marsala | CU63 |
| ◆ Morel | CU24 |
| ◆ Navy | CU98 |
| ◆ Peacock | CU97 |
| ◆ Pear | CU84 |
| ◆ Ruby | CU67 |
| ◆ Sapphire | CU09 |

GRADE 1 *continued*

| COMPASS | COMP |
|---------------|--------|
| ◆ Beach | COMP16 |
| ◆ Bittersweet | COMP46 |
| ◆ Chocolate | COMP49 |
| ◆ Ink | COMP10 |
| ◆ Meadow | COMP82 |
| ◆ Midnight | COMP90 |
| ◆ Putty | COMP22 |
| ◆ Ruby | COMP62 |
| ◆ Sterling | COMP19 |
| ◆ Taupe | COMP26 |
| ◆ Tide | COMP96 |

| COMPASS FOAM* | COMF |
|---------------|--------|
| ◆ Bittersweet | COMF46 |
| ◆ Ink | COMF10 |
| ◆ Meadow | COMF82 |
| ◆ Midnight | COMF90 |
| ◆ Putty | COMF22 |
| ◆ Sterling | COMF19 |

**This fabric available for Solve* Upholstered Back models only.*

| CONTOURETT | UR |
|---------------|------|
| ◆ Baltic | UR94 |
| ◆ Beach | UR23 |
| ◆ Black | UR10 |
| ◆ Bordeaux | UR63 |
| ◆ Buff | UR22 |
| ◆ Cloud | UR18 |
| ◆ Coffee Bean | UR49 |
| ◆ Crater | UR51 |
| ◆ Flame | UR62 |
| ◆ Graphite | UR19 |
| ◆ Iron | UR20 |
| ◆ Luggage | UR26 |
| ◆ Marine | UR92 |
| ◆ Navy | UR95 |
| ◆ Nimbus | UR93 |
| ◆ Ocean | UR96 |
| ◆ Pumpkin | UR42 |
| ◆ Quarry | UR24 |
| ◆ Red | UR64 |
| ◆ Safari | UR27 |
| ◆ Sage | UR82 |
| ◆ Steel | UR21 |
| ◆ Storm | UR17 |
| ◆ Taupe | UR28 |
| ◆ Trunk | UR50 |

GRADE 1 *continued*

| DAPPER | DAPR |
|--------------|--------|
| ◆ Ash | DAPR20 |
| ◆ Azalea * | DAPR95 |
| ◆ Breeze | DAPR06 |
| ◆ Canvas | DAPR25 |
| ◆ Charcoal | DAPR01 |
| ◆ Clover | DAPR22 |
| ◆ Currant | DAPR00 |
| ◆ Emerald * | DAPR75 |
| ◆ Fawn | DAPR35 |
| ◆ Fern | DAPR85 |
| ◆ Gerbera | DAPR16 |
| ◆ Grape | DAPR33 |
| ◆ Jewel | DAPR08 |
| ◆ Marigold | DAPR65 |
| ◆ Onyx | DAPR10 |
| ◆ Orchid | DAPR90 |
| ◆ Parrot | DAPR59 |
| ◆ Peony * | DAPR50 |
| ◆ Pool * | DAPR05 |
| ◆ Poppy | DAPR19 |
| ◆ Rose * | DAPR40 |
| ◆ Sapphire | DAPR07 |
| ◆ Scarlet | DAPR45 |
| ◆ Sepia | DAPR30 |
| ◆ Sky | DAPR44 |
| ◆ Slate | DAPR15 |
| ◆ Sorbet | DAPR55 |
| ◆ Spice * | DAPR60 |
| ◆ Spring | DAPR80 |
| ◆ Terracotta | DAPR13 |
| ◆ Titanium | DAPR17 |
| ◆ Varsity | DAPR09 |
| ◆ Zest | DAPR70 |

| ENSEMBLE | ENSB |
|--------------|--------|
| ◆ Aquamarine | ENSB30 |
| ◆ Ash | ENSB39 |
| ◆ Greige | ENSB36 |
| ◆ Harbor | ENSB34 |
| ◆ Navy | ENSB35 |
| ◆ Oat | ENSB37 |
| ◆ Pear | ENSB33 |
| ◆ Sand | ENSB38 |
| ◆ Scarlet | ENSB32 |
| ◆ Slate | ENSB31 |
| ◆ Stone | ENSB40 |

GRADE 1 *continued*

| HAMILTON | HAML |
|-----------------|--------|
| ◆ Azure | HAML10 |
| ◆ Biscotti | HAML11 |
| ◆ Cabernet | HAML08 |
| ◆ Carolina | HAML21 |
| ◆ Charcoal | HAML17 |
| ◆ Chocolate | HAML13 |
| ◆ Cloud | HAML18 |
| ◆ Dane | HAML16 |
| ◆ Dusty Rose | HAML07 |
| ◆ Esmeralda | HAML06 |
| ◆ Fern | HAML04 |
| ◆ Fresh | HAML03 |
| ◆ Granola | HAML19 |
| ◆ Lilac | HAML14 |
| ◆ Lime | HAML05 |
| ◆ Lipstick | HAML09 |
| ◆ Oxford | HAML20 |
| ◆ Passion Fruit | HAML02 |
| ◆ Pepper | HAML15 |
| ◆ Powder | HAML12 |
| ◆ Sunrise | HAML01 |

| INERTIA | NR |
|------------|------|
| ◆ Amethyst | NR61 |
| ◆ Calypso | NR98 |
| ◆ Cherry | NR66 |
| ◆ Cobalt | NR91 |
| ◆ Coffee | NR49 |
| ◆ Fog | NR19 |
| ◆ Fuchsia | NR63 |
| ◆ Gecko | NR76 |
| ◆ Glow | NR27 |
| ◆ Leaf | NR75 |
| ◆ Lime | NR82 |
| ◆ Loft | NR22 |
| ◆ Mandarin | NR47 |
| ◆ Meteor | NR30 |
| ◆ Mustard | NR26 |
| ◆ Nickel | NR23 |
| ◆ Onyx | NR10 |
| ◆ Regatta | NR90 |
| ◆ Shadow | NR20 |
| ◆ Surf | NR96 |
| ◆ Tangelo | NR46 |

| OPTIC | OP |
|----------------|------|
| ◆ Aurora | OP72 |
| ◆ Bark | OP24 |
| ◆ Canopy | OP84 |
| ◆ Char | OP49 |
| ◆ Ruby | OP42 |
| ◆ Sand | OP17 |
| ◆ Sky | OP83 |
| ◆ Slate | OP19 |
| ◆ Sprout | OP74 |
| ◆ Starry Night | OP11 |
| ◆ Storm | OP56 |
| ◆ Wildfire | OP66 |

* Fabric is de-emphasized.

FABRIC PATTERNS & CODES

GRADE 1 *continued*

| PEBBLE | PBLE |
|-------------|--------|
| ◆ Amber | PBLE01 |
| ◆ Chalk | PBLE02 |
| ◆ Coal | PBLE03 |
| ◆ Gravel | PBLE04 |
| ◆ Magma | PBLE06 |
| ◆ Moss | PBLE05 |
| ◆ Sandstone | PBLE07 |
| ◆ Talc | PBLE08 |
| ◆ Topaz | PBLE09 |
| ◆ Zircon | PBLE10 |

GRADE 2

| APPOINT SEATING | PNS |
|-----------------|--------|
| ◆ Artichoke | PNS014 |
| ◆ Blackberry | PNS012 |
| ◆ Bronze | PNS002 |
| ◆ Carbon | PNS008 |
| ◆ Chai | PNS013 |
| ◆ Cherry | PNS010 |
| ◆ Dark Pewter | PNS017 |
| ◆ Dune | PNS015 |
| ◆ Espresso | PNS003 |
| ◆ Framboise | PNS011 |
| ◆ Frost | PNS034 |
| ◆ Jet | PNS007 |
| ◆ Lawn | PNS005 |
| ◆ Mandarin | PNS009 |
| ◆ Morel | PNS001 |
| ◆ Nimbus | PNS016 |
| ◆ Platinum | PNS004 |
| ◆ Turquoise | PNS006 |

| BLUME | BLME |
|----------------|--------|
| ◆ Chalk | BLME03 |
| ◆ Char | BLME00 |
| ◆ Coin | BLME02 |
| ◆ Driftwood | BLME05 |
| ◆ Emerald City | BLME07 |
| ◆ Fir | BLME09 |
| ◆ Harvest | BLME04 |
| ◆ Haze | BLME08 |
| ◆ Hyacinth | BLME14 |
| ◆ Jasper | BLME13 |
| ◆ Merlot | BLME10 |
| ◆ Moonstone | BLME01 |
| ◆ Opal | BLME06 |
| ◆ Scarlet | BLME11 |
| ◆ Slate | BLME12 |

| CLYDE | CLYD |
|--------------|--------|
| ◆ Antique | CLYD04 |
| ◆ Artifact | CLYD01 |
| ◆ Blacksmith | CLYD10 |
| ◆ Claret | CLYD13 |
| ◆ Craftsman | CLYD08 |
| ◆ Crate | CLYD12 |
| ◆ Fossil | CLYD02 |
| ◆ Heirloom | CLYD05 |
| ◆ Iron | CLYD11 |
| ◆ Keepsake | CLYD15 |
| ◆ Linen | CLYD14 |
| ◆ Relic | CLYD06 |
| ◆ Seasoned | CLYD03 |
| ◆ Trestle | CLYD07 |

GRADE 2 *continued*

| DOTTY | DOT |
|-------------|-------|
| ◆ Candy | DOT63 |
| ◆ Gelato | DOT34 |
| ◆ Indigo | DOT31 |
| ◆ Onyx | DOT35 |
| ◆ Park | DOT83 |
| ◆ Peat | DOT24 |
| ◆ Peony | DOT32 |
| ◆ Suit | DOT20 |
| ◆ Sunflower | DOT33 |
| ◆ Tailor | DOT21 |
| ◆ Tide | DOT90 |
| ◆ Velum | DOT29 |
| ◆ Violet | DOT30 |

| RUSH | RUSH |
|-------------|--------|
| ◆ Anchor | RUSH07 |
| ◆ Basil | RUSH16 |
| ◆ Blueberry | RUSH10 |
| ◆ Flamingo | RUSH21 |
| ◆ Greenery | RUSH15 |
| ◆ Greyhound | RUSH06 |
| ◆ Marina | RUSH13 |
| ◆ Merlot | RUSH19 |
| ◆ Midnight | RUSH11 |
| ◆ Mint | RUSH09 |
| ◆ Mulberry | RUSH18 |
| ◆ Pumice | RUSH01 |
| ◆ Punch | RUSH20 |
| ◆ Sage | RUSH14 |
| ◆ Salsa | RUSH24 |
| ◆ Sand | RUSH05 |
| ◆ Seal | RUSH08 |
| ◆ Soot | RUSH02 |
| ◆ Stout | RUSH03 |
| ◆ Sunshine | RUSH23 |
| ◆ Tapestry | RUSH04 |
| ◆ Tiger | RUSH22 |
| ◆ Vintage | RUSH17 |
| ◆ Wave | RUSH12 |

| SEED | SED |
|-------------|-------|
| ◆ Apple | SED11 |
| ◆ Ash | SED15 |
| ◆ Cardinal | SED09 |
| ◆ Cinder | SED17 |
| ◆ Cream | SED12 |
| ◆ Driftwood | SED13 |
| ◆ Harbor | SED10 |
| ◆ Onyx | SED18 |
| ◆ Smoke | SED16 |
| ◆ Truffle | SED14 |

GRADE 2 *continued*

| SPIN SEATING | SPNN |
|---------------|--------|
| ◆ Alabaster | SPNN02 |
| ◆ Cavern | SPNN03 |
| ◆ Cobblestone | SPNN04 |
| ◆ Ember | SPNN06 |
| ◆ Flame | SPNN07 |
| ◆ Heron | SPNN13 |
| ◆ Oat | SPNN01 |
| ◆ Ocean | SPNN12 |
| ◆ Plum | SPNN15 |
| ◆ Pool | SPNN11 |
| ◆ Raven | SPNN10 |
| ◆ Rhubarb | SPNN14 |
| ◆ Tropic | SPNN08 |
| ◆ Willow | SPNN05 |

| WHISPER VINYL | WP |
|---------------|-------|
| ◆ Antelope | WP20 |
| ◆ Black | WP40 |
| ◆ Bone | WP17 |
| ◆ Bordeaux | WP26 |
| ◆ Brick Red | WP99 |
| ◆ Camel | WP18 |
| ◆ Cappuccino | WP21 |
| ◆ Carotene | WP97 |
| ◆ Cashew | WP29 |
| ◆ Cerulean | WP36 |
| ◆ Charcoal | WP39 |
| ◆ Cinnamon | WP25 |
| ◆ Cognac | WP62 |
| ◆ Cucumber | WP88 |
| ◆ Elephant | WP38 |
| ◆ Espresso | WP49 |
| ◆ Fawn | WP91 |
| ◆ Fog | WP100 |
| ◆ Forest | WP82 |
| ◆ Gravel | WP19 |
| ◆ Indigo | WP86 |
| ◆ Luggage | WP23 |
| ◆ Mahogany | WP93 |
| ◆ Mallard | WP90 |
| ◆ Merlot | WP27 |
| ◆ Molten | WP98 |
| ◆ Navy | WP37 |
| ◆ Ochre | WP96 |
| ◆ Paradise | WP85 |
| ◆ Patina | WP34 |
| ◆ Pewter | WP83 |
| ◆ Putty | WP84 |
| ◆ Salsa | WP42 |
| ◆ Sangre | WP28 |
| ◆ Sassafras | WP89 |
| ◆ Storm | WP92 |
| ◆ Truffle | WP95 |
| ◆ Zest | WP87 |

FABRIC PATTERNS & CODES

GRADE 3

| IN SEASON | ISN |
|-------------|--------|
| ◇ Black | ISN001 |
| ◇ Blue Jay | ISN007 |
| ◇ Fire | ISN004 |
| ◇ Jungle | ISN008 |
| ◇ Lake | ISN006 |
| ◇ Lead | ISN002 |
| ◇ Limestone | ISN041 |
| ◇ Ocean | ISN005 |
| ◇ Silver | ISN003 |
| ◇ Smoke | ISN020 |
| ◇ Tundra | ISN011 |

MOXIE

SX

| | |
|--------------|------|
| ◆ Barnwood | SX09 |
| ◆ Basalt | SX23 |
| ◆ Bayou | SX02 |
| ◆ Biscotti | SX08 |
| ◆ Blackberry | SX48 |
| ◆ Blarney | SX49 |
| ◆ Blueberry | SX05 |
| ◆ Bonsai | SX20 |
| ◆ Carob | SX24 |
| ◆ Chalk | SX50 |
| ◆ Chartreuse | SX34 |
| ◆ Cherry | SX38 |
| ◆ Cinnamon | SX13 |
| ◆ Cobalt | SX01 |
| ◆ Coconut | SX06 |
| ◆ Concrete | SX43 |
| ◆ Cumin | SX32 |
| ◆ Dragonfly | SX44 |
| ◆ Earl Grey | SX40 |
| ◆ Elysian | SX04 |
| ◆ Evergreen | SX21 |
| ◆ Fatigue | SX18 |
| ◆ Fawn | SX30 |
| ◆ Flint | SX39 |
| ◆ Hazel | SX31 |
| ◆ Hemp | SX45 |
| ◆ Hickory | SX25 |
| ◆ Holly | SX51 |
| ◆ Jam | SX16 |
| ◆ Kelly | SX33 |
| ◆ Lemongrass | SX19 |
| ◆ Lime | SX41 |
| ◆ Macintosh | SX12 |
| ◆ Mulberry | SX15 |
| ◆ Parchment | SX07 |
| ◆ Peacock | SX03 |
| ◆ Pineapple | SX42 |
| ◆ Plum | SX17 |
| ◆ Punch | SX46 |
| ◆ Riverstone | SX47 |
| ◆ Russet | SX14 |
| ◆ Smokestack | SX22 |
| ◆ Tangerine | SX37 |
| ◆ Terracotta | SX11 |
| ◆ Thicket | SX35 |
| ◆ Walnut | SX10 |

GRADE 3

continued

| PARKER | PRKR |
|-------------|--------|
| ◇ Aloe | PRKR01 |
| ◆ Cumulus | PRKR05 |
| ◆ Cyan | PRKR06 |
| ◆ Domino | PRKR07 |
| ◆ Fossil | PRKR10 |
| ◆ Graphite | PRKR11 |
| ◇ Grass | PRKR12 |
| ◆ Grenadine | PRKR13 |
| ◆ Griffin | PRKR14 |
| ◆ Kiln | PRKR16 |
| ◆ Magnesium | PRKR18 |
| ◆ Magnet | PRKR19 |
| ◆ Mica | PRKR20 |
| ◆ Mink | PRKR21 |
| ◆ Nightfall | PRKR22 |
| ◆ Paprika | PRKR24 |
| ◆ Pine | PRKR25 |
| ◆ Rapids | PRKR28 |
| ◆ Rioja | PRKR30 |

PURL

PURL

| | |
|------------|--------|
| ◇ Alpaca | PURL08 |
| ◇ Braid | PURL10 |
| ◆ Deep | PURL12 |
| ◆ Graze | PURL05 |
| ◆ Loom | PURL06 |
| ◆ Needle | PURL07 |
| ◆ Pasture | PURL02 |
| ◆ Ranch | PURL04 |
| ◆ Shuttle | PURL09 |
| ◆ Skein | PURL01 |
| ◆ Thistle | PURL11 |
| ◆ Yearling | PURL03 |

QUILL

QUL

| | |
|------------|-------|
| ◇ Aviary | QUL03 |
| ◆ Feather | QUL02 |
| ◆ Fountain | QUL06 |
| ◆ Ink | QUL05 |
| ◆ Metal | QUL04 |
| ◆ Reed | QUL08 |
| ◆ Scroll | QUL01 |
| ◆ Well | QUL07 |

GRADE L1

| DENVER LEATHER | SS |
|----------------|------|
| ◆ Black | SS11 |

For a complete list of fabrics, including partnership fabrics, go to hon.com/fabricsandfinishes.

PANEL FABRIC PATTERNS & CODES

PRICE CODE B

| ANALOG | ANLG |
|-------------------------------------|--------|
| <i>Not available on Accelerate®</i> | |
| ◆ Album | ANLG06 |
| ◆ Cartridge | ANLG04 |
| ◆ Cassette | ANLG09 |
| ◆ Dial | ANLG02 |
| ◆ Media | ANLG08 |
| ◆ Reel | ANLG07 |
| ◆ Signal | ANLG03 |
| ◆ Stereo | ANLG01 |
| ◆ Track | ANLG05 |

| COAST* | COA |
|-------------------------------------|-------|
| <i>Not available on Accelerate®</i> | |
| ◆ Channel | COA14 |
| ◆ Dune | COA03 |
| ◆ Headlands | COA10 |
| ◆ Marsh | COA02 |
| ◆ Pebble | COA12 |
| ◆ Pier | COA13 |
| ◆ Shoal | COA01 |
| ◆ Silt | COA06 |
| ◆ Tide | COA08 |

PRICE CODE B *continued*

| DISPERSE* | DISP |
|----------------|--------|
| ◆ Autumn | DISP03 |
| ◆ Branch | DISP10 |
| ◆ Coffee Bean | DISP13 |
| ◆ Dusk | DISP09 |
| ◆ Emerald City | DISP08 |
| ◆ Gold Rush | DISP02 |
| ◆ Igloo | DISP11 |
| ◆ Ink | DISP06 |
| ◆ Mist | DISP12 |
| ◆ Oatmeal | DISP15 |
| ◆ Prince | DISP07 |
| ◆ Reservoir | DISP01 |
| ◆ Rose | DISP04 |
| ◆ Spring | DISP05 |
| ◆ Steel | DISP16 |
| ◆ Taupe | DISP14 |

| MICA* | MCA |
|--------------|--------|
| ◆ Anthracite | MCA11 |
| ◆ Breeze | MCA18 |
| ◆ Bronze | MCA13 |
| ◆ Buff | MCA14 |
| ◆ Cremini | MCA17 |
| ◆ Crystal | MCAWIT |
| ◆ Dew | MCA20 |
| ◆ Dove | MCA12 |
| ◆ Fresh | MCA16 |
| ◆ Mineral | MCA15 |
| ◆ Nectar | MCA19 |
| ◆ Shale | MCA10 |

PRICE CODE B *continued*

| SPIN* | SPIN |
|---------------|--------|
| ◆ Alabaster | SPIN02 |
| ◆ Cavern | SPIN03 |
| ◆ Cobblestone | SPIN04 |
| ◆ Ember | SPIN06 |
| ◆ Flame | SPIN07 |
| ◆ Heron | SPIN13 |
| ◆ Oat | SPIN01 |
| ◆ Ocean | SPIN12 |
| ◆ Plum | SPIN15 |
| ◆ Pool | SPIN11 |
| ◆ Raven | SPIN10 |
| ◆ Rhubarb | SPIN14 |
| ◆ Tropic | SPIN08 |
| ◆ Willow | SPIN05 |

| TERRAIN* | TRRN |
|-----------|--------|
| ◆ Bay | TRRN05 |
| ◆ Bayou | TRRN35 |
| ◆ Canyon | TRRN30 |
| ◆ Cliff | TRRN45 |
| ◆ Crest | TRRN25 |
| ◆ Delta | TRRN10 |
| ◆ Plateau | TRRN15 |
| ◆ Ridge | TRRN20 |
| ◆ Valley | TRRN40 |

NOTES: Exchange is applied pattern cut and is not available on 78"W tackboards, Voi® screens, and Empower®.

Disperse is applied pattern cut and is not available on 72"W Accelerate® panels and not available on 66"W tackboards, Voi® screens, and Empower®.

◆◆◆ For lead time information see page 17.

* Directional fabrics

ARRANGE®

Want to see more? Scan here
to check out hon.com.



Arrange® Tables shown with Accommodate® Seating.

ARRANGE®

Non-traditional workspace? Transform it with Arrange tables. Ideal for cafés and other collaborative spaces, Arrange tables are available in seated, counter and standing-heights, and can accommodate anywhere from two to eight people. With four tabletop shapes and more than 40 different finish options, you can create a unique and usable space that brings people together.



FEATURES

- Simple, clean design coordinates nicely with other HON furniture.
- The traditional x-base can be updated with a disc shroud.
- Tables come with optional cord grommets and outlets to accommodate a wide range of technical needs — or none at all.
- Aluminum bases are durable, long-lasting and lightweight, making it easy to move and rearrange floor plans.
- Laminate surfaces are durable and resist scratches, spills and stains.

ARRANGE® CAFÉ TABLES ORDERING INFORMATION

LAMINATE

TOPS/L1 LAMINATES CODES

Woodgrain

- ◆ Bourbon Cherry **H**
- ◆ Cognac **COGN**
- ◆ Florence Walnut **LFW1**
- ◆ Harvest **C**
- ◆ Kingswood Walnut **LK11**
- ◆ Mahogany **N**
- ◆ Mocha **MOCH**
- ◆ Natural Maple **D**
- ◆ Pinnacle **PINC**
- ◆ Shaker Cherry **F**
- ◆ Sterling Ash **LSA1**

Solid

- ◆ Black **P**
- ◆ Charcoal **S**
- ◆ Designer White **LDW1**
- ◆ Loft **LOFT**

Patterned

- ◆ Handspun Chestnut **LAHC**
- ◆ Handspun Dove **LAHD**
- ◆ Handspun Pearl **LAHP**
- ◆ Handspun Slate **LAHS**
- ◆ Sheer Mesh * **A5**
- ◆ Silver Mesh **B9**
- ◆ Steel Mesh * **A9**
- ◆ Canyon Zephyr * **K9**
- ◆ Desert Zephyr * **K8**
- ◆ Shadow Zephyr * **K1**
- ◆ Gray **G2**
- ◆ Grey Tigris * **L6**
- ◆ White **G1**
- ◆ Whitestone * **K4**

TOPS/L2 LAMINATES CODES

Woodgrain

- ◆ Lowell Ash **LLA1**
- ◆ Natural Recon **LNR1**
- ◆ Phantom Ecu **LPE1**
- ◆ Portico Teak **LPT1**
- ◆ Skyline Walnut **LSW1**

PAINT

PAINT CODES

P1

- ◆ Textured Black **BLCK**
- ◆ Textured Brownstone **P7J**
- ◆ Textured Charcoal **P7A**
- ◆ Textured Designer White ... **PK7**
- ◆ Textured Loft **P7L**
- ◆ Textured Muslin **P7M**
- ◆ Textured Platinum
Metallic **PLAT**
- ◆ Textured Titanium **P8V**

P2

- ◆ Solar Black **P8X**
- ◆ Textured Silver **PR8**

EDGE BAND

EDGE BAND CODES

- ◆ Black **P**
- ◆ Bourbon Cherry **H**
- ◆ Brownstone **EY**
- ◆ Charcoal **S**
- ◆ Cognac **COGN**
- ◆ Designer White **DW**
- ◆ Florence Walnut **FW**
- ◆ Fossil **EH**
- ◆ Greige **R**
- ◆ Harvest **C**
- ◆ Kingswood Walnut **KI**
- ◆ Loft **LOFT**
- ◆ Lowell Ash **DL**
- ◆ Mahogany **N**
- ◆ Mocha **MOCH**
- ◆ Muslin **T**
- ◆ Natural Maple **D**
- ◆ Natural Recon **NR**
- ◆ Phantom Ecu **PE**
- ◆ Pinnacle **PINC**
- ◆ Platinum **K**
- ◆ Portico Teak **DP**
- ◆ Shadow * **SHDW**
- ◆ Shaker Cherry **F**
- ◆ Skyline Walnut **SW**
- ◆ Sterling Ash **SA**

Recommended Edgeband Color Selection:

| Laminate | | Edgeband | |
|------------------|-------------|------------------|-------------|
| Bourbon Cherry | H | Bourbon Cherry | H |
| Cognac | COGN | Cognac | COGN |
| Florence Walnut | LFW1 | Florence Walnut | FW |
| Grey Tigris | L6 | Greige | R |
| Harvest | C | Harvest | C |
| Kingswood Walnut | LK11 | Kingswood Walnut | KI |
| Mahogany | N | Mahogany | N |
| Mocha | MOCH | Mocha | MOCH |
| Natural Maple | D | Natural Maple | D |
| Pinnacle | PINC | Pinnacle | PINC |
| Shaker Cherry | F | Shaker Cherry | F |
| Sterling Ash | LSA1 | Sterling Ash | SA |
| Black | P | Black | P |
| Charcoal | S | Charcoal | S |
| Designer White | LDW1 | Designer White | DW |
| Whitestone | K4 | Muslin | T |
| Sheer Mesh | A5 | Muslin | T |
| Silver Mesh | B9 | Loft | LOFT |
| Steel Mesh | A9 | Charcoal | S |
| Canyon Zephyr | K9 | Greige | R |
| Desert Zephyr | K8 | Greige | R |
| Shadow Zephyr | K1 | Loft | LOFT |
| Lowell Ash | LLA1 | Lowell Ash | DL |
| Natural Recon | LNR1 | Natural Recon | NR |
| Phantom Ecu | LPE1 | Phantom Ecu | PE |
| Portico Teak | LPT1 | Portico Teak | DP |
| Skyline Walnut | LSW1 | Skyline Walnut | SW |
| Loft | LOFT | Loft | LOFT |

◆◆◆ For lead time information see page 17.

* De-emphasized

ARRANGE[®] Café Table Tops

GSA SIN 33721



Icon Legend on page 17

| | DESCRIPTION | MODEL | SHIP WEIGHT | CUBE | LIST PRICE BY LAMINATE GRADE | |
|--|-------------------------------|--------------------|-------------|------|------------------------------|--------------|
| | | | | | L1 | L2 |
| | Café Round Table Tops | | | | | |
| | 24"W Round Top | HCTRND24 | 19 | 1.9 | \$336 | \$351 |
| | 30"W Round Top | HCTRND30 | 31 | 2.9 | \$362 | \$377 |
| | 36"W Round Top | HCTRND36 | 44 | 4.0 | \$394 | \$409 |
| | 42"W Round Top | HCTRND42 | 57 | 5.4 | \$467 | \$487 |
| | Square Table Tops | | | | | |
| | 24"W Square Top | HCTSQR24 | 19 | 2.2 | \$319 | \$334 |
| | 30"W Square Top | HCTSQR30 | 31 | 2.9 | \$344 | \$359 |
| | 36"W Square Top | HCTSQR36 | 44 | 4.1 | \$375 | \$390 |
| | 42"W Square Top | HCTSQR42 | 57 | 5.6 | \$447 | \$467 |
| | Soft Square Table Tops | | | | | |
| | 24"W Soft Square Top | HCTSFT24 | 19 | 1.9 | \$336 | \$351 |
| | 30"W Soft Square Top | HCTSFT30 | 31 | 2.9 | \$362 | \$377 |
| | 36"W Soft Square Top | HCTSFT36 | 44 | 4.0 | \$394 | \$409 |
| | 42"W Soft Square Top | HCTSFT42 | 57 | 5.4 | \$467 | \$487 |
| | Rectangle Table Tops | | | | | |
| | 48"W x 24"D Rectangle Top | HCTRECT2448 | 36 | 3.6 | \$380 | \$395 |
| | 60"W x 24"D Rectangle Top | HCTRECT2460 | 44 | 4.4 | \$416 | \$431 |
| | 72"W x 24"D Rectangle Top | HCTRECT2472 | 56 | 4.9 | \$441 | \$461 |
| | 48"W x 30"D Rectangle Top | HCTRECT3048 | 51 | 4.4 | \$394 | \$409 |
| | 60"W x 30"D Rectangle Top | HCTRECT3060 | 63 | 5.4 | \$441 | \$456 |
| | 72"W x 30"D Rectangle Top | HCTRECT3072 | 75 | 6.0 | \$489 | \$509 |

NOTES:

- 2 grommet cutouts on Rectangles which will be positioned over the installed bases.

HOW TO SPECIFY

| | | | |
|--|--|---|---|
| <p>Select Model Number</p> <p>H C T R N D 2 4 .</p> | <p>Select Grommet Option</p> <p>G Round Grommet (\$15 upcharge) N No Grommet Upcharge doubles for HCTRECT models</p> <p>G .</p> | <p>Select Laminate</p> <p>See page 27</p> <p>C .</p> | <p>Select Edge Color</p> <p>See page 27</p> <p>C</p> |
|--|--|---|---|



Icon Legend on page 17

ARRANGE® Café Table Bases

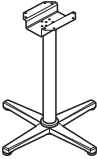
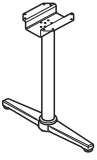
| | DESCRIPTION | MODEL | SHIP WEIGHT | CUBE | LIST PRICE | P2 UPCHARGE |
|---|---|----------------|-------------|--------------|--------------|-------------|
|  | Café Table Bases — X-Base | | | | | |
| | Seated-Height X-base for 24"-30"D Surfaces | HCT29SX | 22 | 3.3 | \$509 | \$20 |
| | Seated-Height X-base for 36"D Surfaces | HCT29MX | 23 | 3.3 | \$566 | \$20 |
| | Seated-Height X-base for 42"D Surfaces | HCT29LX | 25 | 3.3 | \$621 | \$20 |
| | Counter-Height X-base for 24"-30"D Surfaces | HCT36SX | 24 | 4.6 | \$566 | \$20 |
| | Counter-Height X-base for 36"D Surfaces | HCT36MX | 25 | 4.6 | \$621 | \$20 |
| | Counter-Height X-base for 42"D Surfaces | HCT36LX | 27 | 4.6 | \$678 | \$20 |
| | Bar-Height X-base for 24"-30"D Surfaces | HCT42SX | 25 | 4.6 | \$621 | \$20 |
| | Bar-Height X-base for 36"D Surfaces | HCT42MX | 26 | 4.6 | \$678 | \$20 |
| Bar-Height X-base for 42"D Surfaces | HCT42LX | 27 | 4.6 | \$734 | \$20 | |
|  | Café Table Bases — T-Leg Base | | | | | |
| | Seated-Height T-legs for 24"D Surfaces (2 bases incl.) | HCT29ST | 33 | 3.3 | \$689 | \$20 |
| | Seated-Height T-legs for 30"D Surfaces (2 bases incl.) | HCT29MT | 34 | 3.3 | \$767 | \$20 |
| | Counter-Height T-legs for 24"D Surfaces (2 bases incl.) | HCT36ST | 36 | 4.6 | \$741 | \$20 |
| | Counter-Height T-legs for 30"D Surfaces (2 bases incl.) | HCT36MT | 37 | 4.6 | \$799 | \$20 |
| | Bar-Height T-legs for 24"D Surfaces (2 bases incl.) | HCT42ST | 37 | 4.6 | \$794 | \$20 |
| Bar-Height T-legs for 30"D Surfaces (2 bases incl.) | HCT42MT | 38 | 4.6 | \$852 | \$20 | |

NOTES:

- Wire management is standard through table column.
- Adjustable glides available on all feet.

HOW TO SPECIFY

| | |
|----------------------------|---------------------------|
| Select Model Number | Select Paint Color |
| | See page 27 |
| HCT29SX | BLCK |

ARRANGE[®] Café Accessories

GSA SIN 3372IT EXCEPT AS NOTED



Icon Legend on page 17

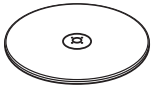

SIN 33721



DESCRIPTION

Café Table Bases — Disc Shroud

Small Disc Shroud for bases that support 24"-30" Surfaces
 Medium Disc Shroud for bases that support 36" Surfaces
 Large Disc Shroud for bases that support 42" Surfaces

MODEL

SHIP WEIGHT

CUBE

LIST PRICE

| | | | |
|-----------------------|------|-----|--------------|
| HCTS DS | 9.0 | 2.0 | \$102 |
| HCTM DS | 12.0 | 2.4 | \$118 |
| HCTL DS | 17.0 | 3.4 | \$136 |

NOTES: Shroud is used as an optional accessory to provide the aesthetic of a disc base. Shroud can be added to existing X-base configurations to provide a new and updated aesthetic. Shroud is made of 18 gauge steel.

- ! Shroud to be used in conjunction with X-bases only and cannot be used with a T-leg configuration.
- ! Shroud cannot be used as a support piece by itself.

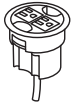

Power Hub, 3" Grommet Mount, 6' Cord

HGRMTAC

1.3

0.2

\$126

- Fits in 3" round grommet cutouts.
- Two grounded AC power outlets.
- Includes 6' cord with three-prong plug.
- Field installed with Plug-and-play ease.

NOTES: For additional information see page 204.

- ! Available in black only (no color designation so use .X - Specify: HGRMTAC.X).

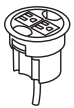

Power Hub, 3" Grommet Mount, 10' Cord

HGRMTAC2

1.5

0.2

\$159

- Includes 10' cord with three-prong plug.
- Fits in 3" round grommet holes.
- Two grounded AC power outlets.
- Field installed with Plug-and-play ease.

- ! Available in black finish only, no specification needed.

NOTES:

- ! HGRMTUSB2 is not compatible with Arrange[®] bases.

HOW TO SPECIFY

Select Model Number

Select Paint Color

For HCTS**DS**, HCTM**DS** and HCTL**DS** models only
 See page 27

H C T S D S .

B L C K

BETWEEN™ TABLES

Want to see more? Scan here
to check out hon.com.



Between™ Tables shown with
Motivate® and Ignition® Seating.

BETWEEN™ TABLES

That moment when everything you want meets everything you need. Choose Between table options that offer up a variety of sizes and top shapes, seated or café heights, training tables with fixed or nesting bases, and a wide range of laminates to fit in with any environment. With so many different uses, it will be easy to pick Between. Whether you're working here, there, or anywhere Between, this table collection's got you covered.



FEATURES

- Allows you to get the most out of every inch of space by creating hubs for people to engage, socialize, and be productive.
- This versatile, lightweight table line is simple to specify and easy to reconfigure, all at a competitive price point.
- Round, square, soft square, or rectangle tops and fixed, nesting, disc, or X-bases, allow versatility in design and function.
- With both standing- and seated-height options, Between tables can be used in multiple areas throughout your office, such as breakrooms, cafés, or breakaway spaces that support today's agile workforce.
- Choose from multiple, durable, high-quality laminate, edge, and finish options.

BETWEEN™ ORDERING INFORMATION

LAMINATE

TOPS/L1 LAMINATES CODES

Woodgrain

- ◆ Bourbon Cherry H
- ◆ Cognac COGN
- ◆ Florence Walnut LFW1
- ◆ Harvest C
- ◆ Kingswood Walnut LK11
- ◆ Mahogany N
- ◆ Mocha MOCH
- ◆ Natural Maple D
- ◆ Pinnacle PINC
- ◆ Shaker Cherry F
- ◆ Sterling Ash LSA1

Solid

- ◆ Black P
- ◆ Charcoal S
- ◆ Designer White LDW1
- ◆ Loft LOFT

Patterned

- ◆ Handspun Chestnut LAHC
- ◆ Handspun Dove LAHD
- ◆ Handspun Pearl LAHP
- ◆ Handspun Slate LAHS
- ◆ Sheer Mesh * A5
- ◆ Silver Mesh B9
- ◆ Steel Mesh * A9
- ◆ Canyon Zephyr * K9
- ◆ Desert Zephyr * K8
- ◆ Shadow Zephyr * K1
- ◆ Whitestone * K4

TOPS/L2 LAMINATES CODES

Woodgrain

- ◆ Lowell Ash LLA1
- ◆ Natural Recon LNR1
- ◆ Phantom Ecru LPE1
- ◆ Portico Teak LPT1
- ◆ Skyline Walnut LSW1

SEATED-, STANDING-, AND X-BASES

PAINT CODES

- P1**
- ◆ Black Mica Texture P6P
 - ◆ Textured Brownstone P7J
 - ◆ Textured Charcoal P7A
 - ◆ Textured Designer White ... PK7
 - ◆ Textured Loft P7L
 - ◆ Textured Muslin P7M
 - ◆ Textured Titanium P8V
- P2**
- ◆ Textured Silver PR8

FIXED AND NESTING BASES

PAINT CODES

- P1**
- ◆ Black P71
 - ◆ Brownstone P7D
 - ◆ Charcoal P02
 - ◆ Designer White PJW
 - ◆ Fossil P28
 - ◆ Greige T5
 - ◆ Loft LOFT
 - ◆ Muslin T3
 - ◆ Titanium P8T
- P2**
- ◆ Silver PR6

EDGE BAND

EDGE BAND CODES

- ◆ Black P
- ◆ Bourbon Cherry H
- ◆ Brownstone EY
- ◆ Charcoal S
- ◆ Cognac COGN
- ◆ Designer White DW
- ◆ Florence Walnut FW
- ◆ Fossil EH
- ◆ Greige R
- ◆ Harvest C
- ◆ Kingswood Walnut KI
- ◆ Loft LOFT
- ◆ Lowell Ash DL
- ◆ Mahogany N
- ◆ Mocha MOCH
- ◆ Muslin T
- ◆ Natural Maple D
- ◆ Natural Recon NR
- ◆ Phantom Ecru PE
- ◆ Pinnacle PINC
- ◆ Platinum K
- ◆ Portico Teak DP
- ◆ Shadow * SHDW
- ◆ Shaker Cherry F
- ◆ Skyline Walnut SW
- ◆ Sterling Ash SA

Recommended Edgeband Color Selection:

| Laminate | | Edgeband | |
|------------------|------|------------------|------|
| Bourbon Cherry | H | Bourbon Cherry | H |
| Cognac | COGN | Cognac | COGN |
| Florence Walnut | LFW1 | Florence Walnut | FW |
| Harvest | C | Harvest | C |
| Kingswood Walnut | LK11 | Kingswood Walnut | KI |
| Mahogany | N | Mahogany | N |
| Mocha | MOCH | Mocha | MOCH |
| Natural Maple | D | Natural Maple | D |
| Pinnacle | PINC | Pinnacle | PINC |
| Shaker Cherry | F | Shaker Cherry | F |
| Sterling Ash | LSA1 | Sterling Ash | SA |
| Black | P | Black | P |
| Charcoal | S | Charcoal | S |
| Designer White | LDW1 | Designer White | DW |
| Whitestone | K4 | Muslin | T |
| Sheer Mesh | A5 | Muslin | T |
| Silver Mesh | B9 | Loft | LOFT |
| Steel Mesh | A9 | Charcoal | S |
| Canyon Zephyr | K9 | Greige | R |
| Desert Zephyr | K8 | Greige | R |
| Shadow Zephyr | K1 | Loft | LOFT |
| Lowell Ash | LLA1 | Lowell Ash | DL |
| Natural Recon | LNR1 | Natural Recon | NR |
| Phantom Ecru | LPE1 | Phantom Ecru | PE |
| Portico Teak | LPT1 | Portico Teak | DP |
| Skyline Walnut | LSW1 | Skyline Walnut | SW |
| Loft | LOFT | Loft | LOFT |





◆◆◆ For lead time information see page 17.

* De-emphasized

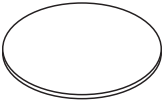

Icon Legend on page 17

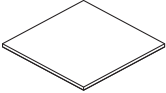
BETWEEN™ Table Tops

| | DESCRIPTION | MODEL | SHIP WEIGHT | CUBE | LIST PRICE BY LAMINATE GRADE | |
|---|-------------------------------|---|-------------|------|------------------------------|--------------|
| | | | | | L1 | L2 |
|  | Round Table Tops | | | | | |
| | 30"W Round Top | HBTRND30 | 31 | 2.9 | \$338 | \$353 |
| | 36"W Round Top | HBTRND36  | 44 | 4.0 | \$370 | \$386 |
| | 42"W Round Top | HBTRND42 | 57 | 5.4 | \$437 | \$457 |
|  | Square Table Tops | | | | | |
| | 30"W Square Top | HBTSQR30 | 31 | 2.9 | \$322 | \$336 |
| | 36"W Square Top | HBTSQR36 | 44 | 4.1 | \$352 | \$368 |
| | 42"W Square Top | HBTSQR42 | 57 | 5.6 | \$418 | \$437 |
|  | Soft Square Table Tops | | | | | |
| | 30"W Soft Square Top | HBTSFT30 | 31 | 2.9 | \$338 | \$353 |
| | 36"W Soft Square Top | HBTSFT36 | 44 | 4.0 | \$370 | \$386 |
| | 42"W Soft Square Top | HBTSFT42 | 57 | 5.4 | \$437 | \$457 |

HOW TO SPECIFY

| | | | |
|--|--|---|---|
| <p>Select Model Number</p> <p>H B T T R N D 3 0</p> | <p>Select Grommet Option</p> <p>N No Grommet</p> <p>N</p> | <p>Select Laminate</p> <p>See page 32</p> <p>C</p> | <p>Select Edge Color</p> <p>See page 32</p> <p>C</p> |
|--|--|---|---|

BETWEEN™ Table Bases

OPEN MARKET EXCEPT AS NOTED



Icon Legend on page 17

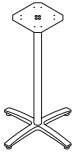

SIN 33721

| DESCRIPTION | MODEL | SHIP WEIGHT | CUBE | LIST PRICE |
|---|-------------------|-------------|------|--------------|
| X-Base | | | | |
| Seated-Height X-base for Support of 30", 36" Tops | HBTTX30S | 27 | 5.2 | \$325 |
| Seated-Height X-base for Support of 42" Tops | HBTTX30L | 29 | 5.2 | \$476 |
| Bar-Height X-base for Support of 30", 36" Tops | HBTTX42S ⓘ | 30 | 5.2 | \$391 |
| Bar-Height X-base for 42" Tops | HBTTX42L ⓘ | 34 | 5.2 | \$546 |

NOTES:

- Seated-Height (30³/₄" to top of surface).
- Bar-Height (42¹/₄" to top of surface).
- Adjustable glides with ³/₄" adjustment available on all feet.



| | | | | |
|--|----------------|----|-----|--------------|
| Seated-Height Disc Base | HBTTD30 | 24 | 3.3 | \$392 |
| ⓘ Disc Base not for use with 42" square top. | | | | |

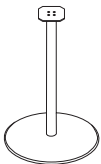

| | | | | |
|--|----------------|----|-----|--------------|
| Standing-Height Disc Base | HBTTD42 | 27 | 3.3 | \$463 |
| ⓘ Disc Base not for use with 42" square top. | | | | |

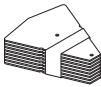

| | | | | |
|--|---------------|----|-----|--------------|
| Counterweight Kit for Disc Base | HBTTCW | 16 | 0.2 | \$156 |
| ⓘ Required when using disc base with 42" round and soft square tops. Optional for smaller top sizes. | | | | |

NOTES:

- Seated-Height (29" to top of surface).
- Bar-Height (42" to top of surface).
- Counterweight Kit required when using disc base with 42" round or soft square tops. Kit can be used for added stability on 30" or 36" round, square, and soft square tops if desired.

HOW TO SPECIFY

| | |
|---|--|
| <p>Select Model Number</p> <p>HBTTX30S .</p> | <p>Select Paint Color</p> <p>See page 32</p> <p>PR8</p> |
|---|--|

OPEN MARKET



Icon Legend on page 17

BETWEEN™ Rectangular Table Tops

TABLES

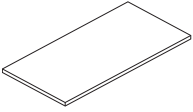
| | DESCRIPTION | MODEL | SHIP WEIGHT | CUBE | LIST PRICE BY LAMINATE GRADE | |
|---|-------------------------------|------------------|-------------|------|------------------------------|--------------|
| | | | | | L1 | L2 |
|  | Rectangular Table Tops | | | | | |
| | 48"W x 24"D | HMPTT2448 | 45 | 3.7 | \$378 | \$395 |
| | 60"W x 24"D | HMPTT2460 | 57 | 4.5 | \$418 | \$437 |
| | 72"W x 24"D | HMPTT2472 | 68 | 5.0 | \$463 | \$484 |
| | 48"W x 30"D | HMPTT3048 | 57 | 4.4 | \$394 | \$412 |
| | 60"W x 30"D | HMPTT3060 | 71 | 5.4 | \$431 | \$451 |
| | 72"W x 30"D | HMPTT3072 | 85 | 6.0 | \$492 | \$514 |

NOTES:

- HON 5-Year Limited Warranty.

HOW TO SPECIFY

| | | | |
|--|--|---|---|
| <p>Select Model Number</p> <p>HMPTT2448</p> | <p>Select Grommet Option</p> <p>N No Grommet</p> <p>N</p> | <p>Select Laminate</p> <p>See page 32</p> <p>C</p> | <p>Select Edge Color</p> <p>See page 32</p> <p>C</p> |
|--|--|---|---|

OPEN MARKET



Icon Legend on page 17

BETWEEN™ Table Bases for Rectangular Tops

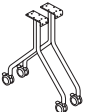
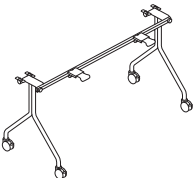
| | DESCRIPTION | MODEL | SHIP WEIGHT | CUBE | LIST PRICE |
|---|---|-----------------|-------------|------|--------------|
|  | Fixed Leg | HMPTBFX | 27 | 6.3 | \$287 |
|  | Nesting Base | | | | |
| | For use with 48"W Rectangular Tops | HMPTBNSS | 18 | 6.3 | \$331 |
| | For use with 60"W and 72"W Rectangular Tops | HMPTBNSL | 19 | 6.3 | \$353 |

NOTES:

- Tops and bases ship in separate cartons.
- Recommend ordering HMAGANG when intending to gang multiple tables together. See page 61.
- HON 5-Year Limited Warranty.

HOW TO SPECIFY

| | |
|--|--|
| <p>Select Model Number</p> <p>HMPTBFX</p> | <p>Select Paint Color</p> <p>See page 32</p> <p>P71</p> |
|--|--|

BETWEEN™ Nesting Tables

OPEN MARKET



Icon Legend on page 17

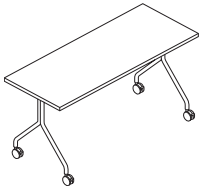

DESCRIPTION

Nesting Table

48"W x 24"D
60"W x 24"D
72"W x 24"D

48"W x 30"D
60"W x 30"D
72"W x 30"D

MODEL

SHIP WEIGHT

CUBE

LIST PRICE

| | | | |
|-------------------|-----|------|--------------|
| HMPT2448NS | 69 | 8.9 | \$638 |
| HMPT2460NS | 81 | 10.7 | \$693 |
| HMPT2472NS | 92 | 12.4 | \$733 |
| HMPT3048NS | 81 | 10.9 | \$651 |
| HMPT3060NS | 95 | 13.1 | \$705 |
| HMPT3072NS | 109 | 15.0 | \$759 |

NOTES:

- Top and base ship in one carton.
- Limited finishes available on single-carton tables.
- Recommend ordering HMAGANG when intending to gang multiple tables together. See page 61.
- **HON 5-Year Limited Warranty.**

HOW TO SPECIFY

| | | | |
|---|---|--|--|
| Select Model Number H M P T 2 4 4 8 N S . | Select Grommet Option N No Grommet N . | Select Laminate/Edge B9LOFT Silver Mesh/Loft Edge FF Shaker Cherry/Shaker Cherry Edge PINCPINC Pinnacle/Pinnacle Edge B 9 L O F T . | Select Base Paint P71 Black P 7 1 |
|---|---|--|--|

BETWEEN™ Shared Components

GSA SIN 33721



Icon Legend on page 17

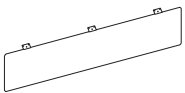

DESCRIPTION

Universal Modesty Panel

For 48"W Between™ Tables
For 60"/72"W Between™ Tables

MODEL

SHIP WEIGHT

CUBE

LIST PRICE BY PAINT GRADE

P1

P2

| | | | | |
|------------------|----|-----|--------------|--------------|
| HMTUMOD38 | 11 | 2.2 | \$241 | \$261 |
| HMTUMOD50 | 14 | 3.1 | \$263 | \$283 |

NOTES:

- Table Modesty Panels are hinged for use with Nesting Table models.

HOW TO SPECIFY

| | |
|---|---|
| Select Model Number H M T U M O D 3 8 . | Select Paint Color See page 32 T 1 |
|---|---|



Icon Legend on page 17

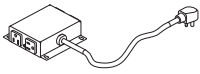

DESCRIPTION

Under Worksurface Power Module

NOTES: For additional information see page 205.

MODEL

HPWRMOD2

SHIP WEIGHT

1.5

CUBE

0.2

LIST PRICE

\$441

HOW TO SPECIFY

Select
Model Number

HPWRMOD2

BIRK™ TABLES

Want to see more? Scan here
to check out [hon.com](https://www.hon.com).



Birk™ Tables

BIRK™ TABLES

Why complicate matters when you can keep it simple? Offering a modern, minimalist design, Birk tables have a look that's as streamlined as its specification process. Whether you're looking for something well-rounded or think it's hip to be square, Birk is there for you with a variety of top shapes, sizes, and table heights. It's the support system you need to help people come together, collaborate, and socialize — anywhere.



FEATURES

- Ideal for informal meeting spaces and hospitality areas.
- Modern, minimalist design makes it easy to match a variety of styles.
- Designed for use with HON chairs, stools, and soft seating.
- Five different base heights outfit a variety of spaces.
- Five unique top shapes and sizes coordinate seamlessly with any surrounding aesthetic.
- The personal table is light in scale and gives people the ability to take notes and work in a lounge setting.

BIRK™ ORDERING INFORMATION

LAMINATE

L1 LAMINATES CODES

Woodgrain

- ◆ Bourbon Cherry **H**
- ◆ Cognac **COGN**
- ◆ Florence Walnut **LFW1**
- ◆ Harvest **C**
- ◆ Kingswood Walnut **LK11**
- ◆ Mahogany **N**
- ◆ Mocha **MOCH**
- ◆ Natural Maple **D**
- ◆ Pinnacle **PINC**
- ◆ Shaker Cherry **F**
- ◆ Sterling Ash **LSA1**

Solid

- ◆ Black **P**
- ◆ Charcoal **S**
- ◆ Designer White **LDW1**
- ◆ Loft **LOFT**

Patterned

- ◆ Handspun Chestnut **LAHC**
- ◆ Handspun Dove **LAHD**
- ◆ Handspun Pearl **LAHP**
- ◆ Handspun Slate **LAHS**
- ◆ Sheer Mesh * **A5**
- ◆ Silver Mesh **B9**
- ◆ Steel Mesh * **A9**

L2 LAMINATES CODES

Woodgrain

- ◆ Lowell Ash **LLA1**
- ◆ Natural Recon **LNRI**
- ◆ Phantom Ecu **LPE1**
- ◆ Portico Teak **LPT1**
- ◆ Skyline Walnut **LSW1**

EDGE BAND

EDGE BAND CODES

- ◆ Black **P**
- ◆ Bourbon Cherry **H**
- ◆ Brownstone **EY**
- ◆ Charcoal **S**
- ◆ Cognac **COGN**
- ◆ Designer White **DW**
- ◆ Florence Walnut **FW**
- ◆ Fossil **EH**
- ◆ Greige **R**
- ◆ Harvest **C**
- ◆ Kingswood Walnut **KI**
- ◆ Loft **LOFT**
- ◆ Lowell Ash **DL**
- ◆ Mahogany **N**
- ◆ Mocha **MOCH**
- ◆ Muslin **T**
- ◆ Natural Maple **D**
- ◆ Natural Recon **NR**
- ◆ Phantom Ecu **PE**
- ◆ Pinnacle **PINC**
- ◆ Platinum **K**
- ◆ Portico Teak **DP**
- ◆ Shaker Cherry **F**
- ◆ Skyline Walnut **SW**
- ◆ Sterling Ash **SA**

PAINT

PAINT CODES

P1

- ◆ Black Mica Texture **P6P**
- ◆ Textured Brownstone **P7J**
- ◆ Textured Charcoal **P7A**
- ◆ Textured Designer White ... **PK7**
- ◆ Textured Loft **P7L**
- ◆ Textured Muslin **P7M**
- ◆ Textured Titanium **P8V**

P2

- ◆ Solar Black **P8X**
- ◆ Textured Silver **PR8**

Recommended Edgeband Color Selection:

| Laminate | | Edgeband | |
|------------------|-------------|------------------|-------------|
| Bourbon Cherry | H | Bourbon Cherry | H |
| Cognac | COGN | Cognac | COGN |
| Florence Walnut | LFW1 | Florence Walnut | FW |
| Harvest | C | Harvest | C |
| Kingswood Walnut | LK11 | Kingswood Walnut | KI |
| Mahogany | N | Mahogany | N |
| Mocha | MOCH | Mocha | MOCH |
| Natural Maple | D | Natural Maple | D |
| Pinnacle | PINC | Pinnacle | PINC |
| Shaker Cherry | F | Shaker Cherry | F |
| Sterling Ash | LSA1 | Sterling Ash | SA |
| Black | P | Black | P |
| Charcoal | S | Charcoal | S |
| Designer White | LDW1 | Designer White | DW |
| Sheer Mesh | A5 | Muslin | T |
| Silver Mesh | B9 | Loft | LOFT |
| Steel Mesh | A9 | Charcoal | S |
| Lowell Ash | LLA1 | Lowell Ash | DL |
| Natural Recon | LNRI | Natural Recon | NR |
| Phantom Ecu | LPE1 | Phantom Ecu | PE |
| Portico Teak | LPT1 | Portico Teak | DP |
| Skyline Walnut | LSW1 | Skyline Walnut | SW |
| Loft | LOFT | Loft | LOFT |

* De-emphasized

BIRK™ Table Tops

OPEN MARKET



Icon Legend on page 17

| | DESCRIPTION | MODEL | SHIP WEIGHT | CUBE | LIST PRICE BY LAMINATE GRADE | |
|--|--|-------------|-------------|------|------------------------------|--------|
| | | | | | L1 | L2 |
| | Round Tops with Knife Edge | | | | | |
| | 30"W Round Top | HCWTRND30J | 28 | 2.8 | \$477 | \$500 |
| | 36"W Round Top | HCWTRND36J | 38 | 3.8 | \$520 | \$545 |
| | 42"W Round Top | HCWTRND42J | 50 | 5.1 | \$613 | \$642 |
| | Round Tops with Flat Edge | | | | | |
| | 30"W Round Top | HCWTRND30G | 28 | 2.8 | \$368 | \$385 |
| | 36"W Round Top | HCWTRND36G | 38 | 3.8 | \$400 | \$419 |
| | 42"W Round Top | HCWTRND42G | 50 | 5.1 | \$473 | \$495 |
| | Square Tops with Knife Edge | | | | | |
| | 30"W Square Top | HCWTSQR30J | 34 | 2.6 | \$422 | \$442 |
| | 36"W Square Top | HCWTSQR36J | 47 | 3.8 | \$495 | \$518 |
| | 42"W Square Top | HCWTSQR42J | 62 | 5.0 | \$586 | \$614 |
| | Square Tops with Flat Edge | | | | | |
| | 30"W Square Top | HCWTSQR30G | 34 | 2.6 | \$326 | \$342 |
| | 36"W Square Top | HCWTSQR36G | 47 | 3.8 | \$381 | \$399 |
| | 42"W Square Top | HCWTSQR42G | 62 | 5.0 | \$452 | \$473 |
| | Soft Square Tops with Knife Edge | | | | | |
| | 30"W Soft Square Top | HCWTSFTS30J | 34 | 2.6 | \$477 | \$500 |
| | 36"W Soft Square Top | HCWTSFTS36J | 47 | 3.8 | \$520 | \$545 |
| | 42"W Soft Square Top | HCWTSFTS42J | 62 | 5.0 | \$613 | \$642 |
| | Soft Square Tops with Flat Edge | | | | | |
| | 30"W Soft Square Top | HCWTSFTS30G | 34 | 2.6 | \$368 | \$385 |
| | 36"W Soft Square Top | HCWTSFTS36G | 47 | 3.8 | \$400 | \$419 |
| | 42"W Soft Square Top | HCWTSFTS42G | 62 | 5.0 | \$473 | \$495 |
| | Booth Tops with Knife Edge | | | | | |
| | 56"W x 36"D Booth Top | HCWTB3656J | 90 | 5.6 | \$661 | \$692 |
| | 84"W x 36"D Booth Top | HCWTB3684J | 150 | 8.2 | \$997 | \$1044 |
| | Booth Tops with Flat Edge | | | | | |
| | 56"W x 36"D Booth Top | HCWTB3656G | 90 | 5.6 | \$508 | \$532 |
| | 84"W x 36"D Booth Top | HCWTB3684G | 150 | 8.2 | \$767 | \$803 |
| | Soft Rectangle Tops with Knife Edge | | | | | |
| | 56"W x 36"D Soft Rectangle Top | HCWTSR3656J | 90 | 5.6 | \$688 | \$720 |
| | 84"W x 36"D Soft Rectangle Top | HCWTSR3684J | 150 | 8.2 | \$1025 | \$1073 |
| | Soft Rectangle Tops with Flat Edge | | | | | |
| | 56"W x 36"D Soft Rectangle Top | HCWTSR3656G | 90 | 5.6 | \$529 | \$554 |
| | 84"W x 36"D Soft Rectangle Top | HCWTSR3684G | 150 | 8.2 | \$789 | \$826 |

NOTES:

- Tops configured with pilot holes for easy installation of base.

HOW TO SPECIFY

| | | | |
|--|---|---|---|
| <p>Select Model Number</p> <p>HCWTSQR36J</p> | <p>Select Grommet Option</p> <p>N No Grommet</p> <p>N</p> | <p>Select Laminate</p> <p>See page 39</p> <p>LSA1</p> | <p>Select Edge Color</p> <p>See page 39</p> <p>SA</p> |
|--|---|---|---|

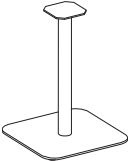
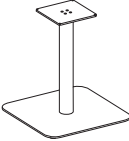
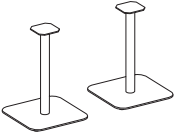

Icon Legend on page 17

| | DESCRIPTION | MODEL | SHIP WEIGHT | CUBE | LIST PRICE BY PAINT GRADE | |
|---|--|-------------------|-------------|------|---------------------------|---------------|
| | | | | | P1 | P2 |
|  | Single Pedestal, Medium | | | | | |
| | Occasional-Height Single Pedestal Base | HCWTSBM18 | 60 | 3.3 | \$592 | \$647 |
| | Working Lounge-Height Single Pedestal Base | HCWTSBM27 | 60 | 3.3 | \$596 | \$652 |
| | Seated-Height Single Pedestal Base | HCWTSBM29 | 60 | 3.3 | \$601 | \$657 |
| | Counter-Height Single Pedestal Base | HCWTSBM36 | 62 | 3.3 | \$607 | \$664 |
| | Bar-Height Single Pedestal Base | HCWTSBM42 | 66 | 3.6 | \$615 | \$673 |
|  | Single Pedestal, Large | | | | | |
| | Occasional-Height Single Pedestal Base | HCWTSBL18 | 95 | 3.8 | \$775 | \$847 |
| | Working Lounge-Height Single Pedestal Base | HCWTSBL27 | 95 | 3.8 | \$802 | \$877 |
| | Seated-Height Single Pedestal Base | HCWTSBL29 | 95 | 3.8 | \$838 | \$916 |
| | Counter-Height Single Pedestal Base | HCWTSBL36 | 98 | 3.8 | \$850 | \$929 |
| | Bar-Height Single Pedestal Base | HCWTSBL42 | 101 | 4.2 | \$867 | \$948 |
|  | Double Pedestal, Medium | | | | | |
| | Working Lounge-Height Double Pedestal Base | HCWTDSBM27 | 120 | 6.5 | \$1192 | \$1304 |
| | Seated-Height Double Pedestal Base | HCWTDSBM29 | 120 | 6.5 | \$1202 | \$1314 |
| | Counter-Height Double Pedestal Base | HCWTDSBM36 | 124 | 6.5 | \$1214 | \$1328 |
| | Bar-Height Double Pedestal Base | HCWTDSBM42 | 132 | 7.2 | \$1230 | \$1346 |

NOTES:

- See application matrix for top and base compatibility.
- Bases feature 1/4" H non-leveling slide glides.
- Some assembly required.

| Top & Base Compatibility Matrix | | Top | | | | |
|---------------------------------|-------------------------|----------------------------|------|------|-----------------------|------|
| | | Round, Square, Soft Square | | | Booth, Soft Rectangle | |
| | | 30"W | 36"W | 42"W | 56"W | 84"W |
| Base | Single Pedestal, Medium | • | • | | | |
| | Single Pedestal, Large | | | • | | |
| | Double Pedestal, Medium | | | | • | • |

HOW TO SPECIFY

| | |
|--|--|
| <p>Select Model Number</p> <p>HCWTSBL36</p> | <p>Select Paint Color</p> <p>See page 39</p> <p>PR8</p> |
|--|--|

BIRK™ Personal Table

OPEN MARKET



Icon Legend on page 17



DESCRIPTION

Personal Table
17"W x 15"D x 28"H

| MODEL | SHIP WEIGHT | CUBE | LIST PRICE BY LAMINATE GRADE | |
|-------|-------------|------|------------------------------|-------|
| | | | L1 | L2 |
| HCWPT | 18 | 2.7 | \$341 | \$351 |

NOTES:

- Top features flat edge on all sides.
- Top configured with pilot holes for easy installation of base.
- Some assembly required.

HOW TO SPECIFY

| | | | |
|---|--|--|--|
| <p>Select Model Number</p> <p>See page 39</p> <p>HCWPT</p> | <p>Select Laminate</p> <p>See page 39</p> <p>LSA1</p> | <p>Select Edge Color</p> <p>See page 39</p> <p>SA</p> | <p>Select Paint Color</p> <p>See page 39</p> <p>P2 upcharge + \$12</p> <p>PR8</p> |
|---|--|--|--|

OPEN MARKET



Icon Legend on page 17

CANTILEVER TABLE

TABLES

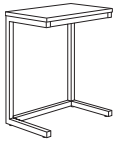

DESCRIPTION

Cantilever Table
17½"W x 9¾"D x 20¾"H

MODEL SHIP WEIGHT CUBE LIST PRICE

HML8858 12.8 1.1 \$203

NOTES:

- HON 5-Year Limited Warranty.

HOW TO SPECIFY

Select Model Number

H M L 8 8 5 8 .

Select Finish

P Black

P

FLOCK®

Want to see more? Scan here
to check out [hon.com](https://www.hon.com).



Flock® Tables and Seating.

FLOCK®

Great things happen when people come together, and Flock Collaborative Tables create the places that help make that possible. Quiet corners. Vibrant communal areas. Beautiful, comfortable spaces where clean lines and distinctive geometric design improve productivity and inspire big ideas. Choose from a variety of mix-and-match shapes and sizes to design spaces where your Flock will flourish.



FEATURES

- Flock Tables coordinate seamlessly with Flock Seating to support collaborative areas in any workplace.
- Choose from Square, Round, Rectangle or Racetrack shaped table tops.
- Table bases available in multiple heights and styles.
- Add convenient options like integrated power, cord grommets and tablet pedestals, and Flock is ready to work.
- Configurable and scalable, Flock Tables offer smaller footprints to better fit compact spaces.

COLLABORATIVE TABLES ORDERING INFORMATION

LAMINATE

TOPS/L1 LAMINATES CODES

Woodgrain

- ◆ Bourbon Cherry **H**
- ◆ Cognac **COGN**
- ◆ Florence Walnut **LFW1**
- ◆ Harvest **C**
- ◆ Kingswood Walnut **LK11**
- ◆ Mahogany **N**
- ◆ Mocha **MOCH**
- ◆ Natural Maple **D**
- ◆ Pinnacle **PINC**
- ◆ Shaker Cherry **F**
- ◆ Sterling Ash **LSA1**

Solid

- ◆ Black **P**
- ◆ Charcoal **S**
- ◆ Designer White **LDW1**
- ◆ Loft **LOFT**

Patterned

- ◆ Handspun Chestnut **LAHC**
- ◆ Handspun Dove **LAHD**
- ◆ Handspun Pearl **LAHP**
- ◆ Handspun Slate **LAHS**
- ◆ Sheer Mesh * **A5**
- ◆ Silver Mesh **B9**
- ◆ Steel Mesh * **A9**
- ◆ Canyon Zephyr * **K9**
- ◆ Desert Zephyr * **K8**
- ◆ Shadow Zephyr * **K1**
- ◆ Whitestone * **K4**

TOPS/L2 LAMINATES CODES

Woodgrain

- ◆ Lowell Ash **LLA1**
- ◆ Natural Recon **LNR1**
- ◆ Phantom Ecu **LPE1**
- ◆ Portico Teak **LPT1**
- ◆ Skyline Walnut **LSW1**

PAINT

PAINT CODES

- P1**
- ◆ Textured Charcoal **P7A**
- P2**
- ◆ Textured Silver **PR8**

EDGE BAND

EDGE BAND CODES

- ◆ Black **P**
- ◆ Bourbon Cherry **H**
- ◆ Brownstone **EY**
- ◆ Charcoal **S**
- ◆ Cognac **COGN**
- ◆ Designer White **DW**
- ◆ Florence Walnut **FW**
- ◆ Fossil **EH**
- ◆ Greige **R**
- ◆ Harvest **C**
- ◆ Kingswood Walnut **KI**
- ◆ Loft **LOFT**
- ◆ Lowell Ash **DL**
- ◆ Mahogany **N**
- ◆ Mocha **MOCH**
- ◆ Muslin **T**
- ◆ Natural Maple **D**
- ◆ Natural Recon **NR**
- ◆ Phantom Ecu **PE**
- ◆ Pinnacle **PINC**
- ◆ Platinum **K**
- ◆ Portico Teak **DP**
- ◆ Shadow * **SHDW**
- ◆ Shaker Cherry **F**
- ◆ Skyline Walnut **SW**
- ◆ Sterling Ash **SA**

Recommended Edgeband Color Selection:

| Laminate | | Edgeband | |
|------------------|-------------|------------------|-------------|
| Bourbon Cherry | H | Bourbon Cherry | H |
| Cognac | COGN | Cognac | COGN |
| Florence Walnut | LFW1 | Florence Walnut | FW |
| Harvest | C | Harvest | C |
| Kingswood Walnut | LK11 | Kingswood Walnut | KI |
| Mahogany | N | Mahogany | N |
| Mocha | MOCH | Mocha | MOCH |
| Natural Maple | D | Natural Maple | D |
| Pinnacle | PINC | Pinnacle | PINC |
| Shaker Cherry | F | Shaker Cherry | F |
| Sterling Ash | LSA1 | Sterling Ash | SA |
| Black | P | Black | P |
| Charcoal | S | Charcoal | S |
| Designer White | LDW1 | Designer White | DW |
| Whitestone | K4 | Muslin | T |
| Sheer Mesh | A5 | Muslin | T |
| Silver Mesh | B9 | Loft | LOFT |
| Steel Mesh | A9 | Charcoal | S |
| Canyon Zephyr | K9 | Greige | R |
| Desert Zephyr | K8 | Greige | R |
| Shadow Zephyr | K1 | Loft | LOFT |
| Lowell Ash | LLA1 | Lowell Ash | DL |
| Natural Recon | LNR1 | Natural Recon | NR |
| Phantom Ecu | LPE1 | Phantom Ecu | PE |
| Portico Teak | LPT1 | Portico Teak | DP |
| Skyline Walnut | LSW1 | Skyline Walnut | SW |
| Loft | LOFT | Loft | LOFT |

◆◆◆ For lead time information see page 17.

* De-emphasized

FLOCK® COLLABORATIVE SOLUTIONS TABLE SPECIFYING INFORMATION

TOP SHAPES

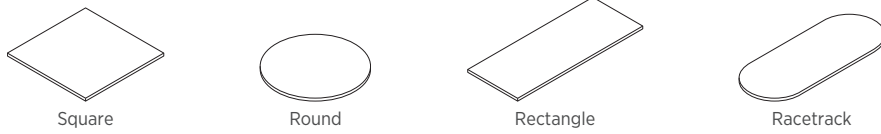
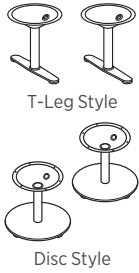
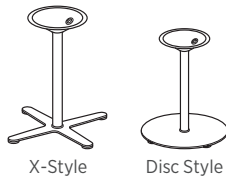

TABLE BASES

For Occasional-Height Tables



For Seated-Height Tables



For 41" H Bar-Height Tables

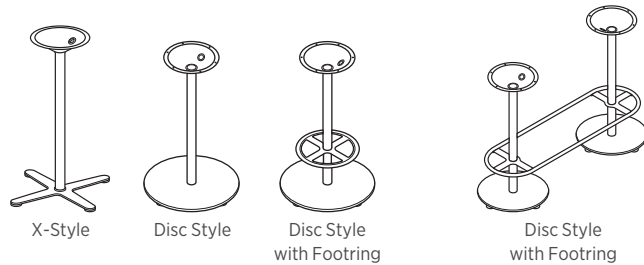

OCCASIONAL TABLES

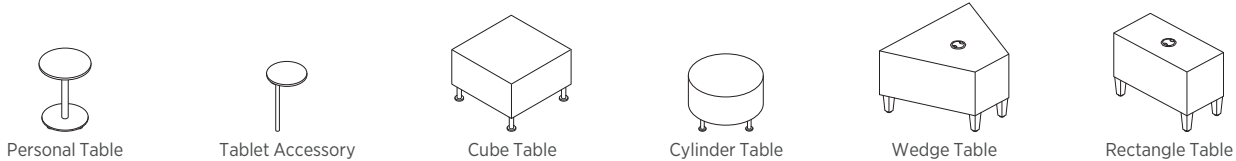

GROMMET MATRIX — ALL TABLES/TOPS

| TOP WIDTH | NO GROMMET | 1-3" ROUND GROMMET CENTERED | 2-3" ROUND GROMMET LEFT & RIGHT |
|-------------------------|------------|-----------------------------|---------------------------------|
| SIF OPTION CODE | N | G | G |
| 24" Cube | YES | YES | N/A |
| 26" Cylinder | YES | YES | N/A |
| 18" Personal | N/A | N/A | N/A |
| 30" Square/Round | YES | YES | N/A |
| 36" Square/Round | YES | YES | N/A |
| 60" Rectangle/Racetrack | YES | N/A | YES |
| 72" Rectangle/Racetrack | YES | N/A | YES |
| 84" Rectangle/Racetrack | YES | N/A | YES |
| 96" Rectangle/Racetrack | YES | N/A | YES |

NOTES: 3" round grommet color will need to be specified for tops. Grommet will coordinate with paint color specified for cube/cylinder tables. Charcoal grommets will be used with Textured Charcoal paint and Platinum Metallic grommets will be used with Textured Silver paint.

Grommet options can be used in conjunction with accessory ports on cube/cylinder tables. Grommet models HGRMTAC and HGRMTDATA on page 51 can also be used with Flock® tables.

3" ROUND GROMMET LOCATIONS

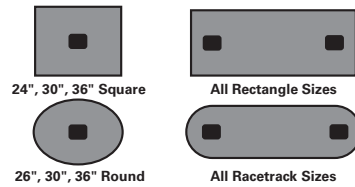

ACCESSORY PORT LOCATIONS

Only applies to models HFTLS24 and HFTLD26.

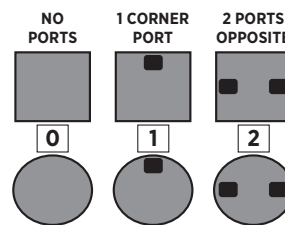

NOTES:

Port location 1 allows for one tablet accessory — see model on pages 49-50.

Port location 2 allows for two tablet accessories — see model on pages 49-50.



FLOCK® Collaborative Laminate Table Tops

| | DESCRIPTION | MODEL | SHIP WEIGHT | CUBE | LIST PRICE BY LAMINATE GRADE | |
|---------------------------|----------------------------|------------------|-------------|--------------|------------------------------|--------------|
| | | | | | L1 | L2 |
| | Laminate Table Tops | | | | | |
| | 36" Square Top | HFTLS36 | 45 | 1.2 | \$468 | \$488 |
| | 30" Square Top | HFTLS30 | 32 | 1.0 | \$415 | \$435 |
| | 36" Round Top | HFTLD36 | 35 | 1.2 | \$468 | \$488 |
| | 30" Round Top | HFTLD30 | 25 | 1.0 | \$415 | \$435 |
| | 96"W x 33"D Rectangle Top | HFTLC3396 | 105 | 2.9 | \$826 | \$861 |
| | 84"W x 33"D Rectangle Top | HFTLC3384 | 90 | 2.5 | \$706 | \$736 |
| | 72"W x 33"D Rectangle Top | HFTLC3372 | 78 | 2.2 | \$591 | \$616 |
| | 60"W x 24"D Rectangle Top | HFTLC2460 | 47 | 1.3 | \$432 | \$447 |
| | 96"W x 33"D Racetrack Top | HFTLA3396 | 101 | 2.9 | \$826 | \$861 |
| 84"W x 33"D Racetrack Top | HFTLA3384 | 83 | 2.5 | \$706 | \$736 | |
| 72"W x 33"D Racetrack Top | HFTLA3372 | 70 | 2.2 | \$591 | \$616 | |
| 60"W x 24"D Racetrack Top | HFTLA2460 | 43 | 1.3 | \$432 | \$447 | |

NOTES:

- Grommet models HGRMTAC and HGRMTDATA on page 51 can also be used with Flock® tables.
- Rectangle and Racetrack tops come with 2 grommet cutouts if specified with Round grommet.
- For a complete line of compatible Flock® collaborative seating solutions, please see pages 284-307.

HOW TO SPECIFY





| | | | |
|--|---|--|--|
| <p>Select Model Number</p> <p>HFTLS36</p> | <p>Select Edge Detail</p> <p>G 2mm Edge</p> <p>Select Edge Color</p> <p>See page 45</p> <p>GK</p> | <p>Select Grommet Option</p> <p>N No Grommet G Round Grommet (\$15 upcharge per grommet cutout)</p> <p>See page 46 for Grommet placement</p> <p>Select Grommet Color</p> <p>S Charcoal T1 Platinum Metallic</p> <p>GT1</p> | <p>Select Laminate Color</p> <p>See page 45</p> <p>K7</p> |
|--|---|--|--|

FLOCK® Collaborative Table Bases

GSA SIN 33721

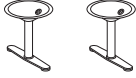
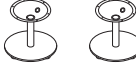

Icon Legend on page 17

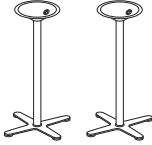
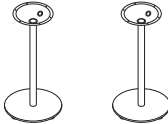
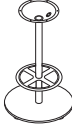
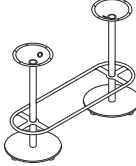
| | DESCRIPTION | MODEL | SHIP WEIGHT | CUBE | LIST PRICE BY PAINT GRADE | |
|--|---|---|-------------------|----------------------|---|---|
| | | | | | P1 | P2 |
|  | Base T-Leg Style — For 18”H Tables For 60”W x 24”D Rectangle or Racetrack Table Tops • Two bases shipped in separate cartons. | HFTB17N | 40 | 6.0 | \$1042 | \$1062 |
|  | Base Disc Style — For 18”H Tables • Use with 60”W x 24”D Racetrack or Rectangle table tops only. • Two bases shipped in separate cartons. | HFDB17N | 74 | 6.0 | \$1142 | \$1162 |
| | Base Disc Style — For 18”H Tables For 30” and 36” Round or Square Table Tops | HFDB17B | 37 | 3.0 | \$560 | \$580 |
|  | Base X-Style — For 29½”H Tables For 30” Round or Square Table Tops For 36” Round or Square Table Tops Use with 33”D x 72”W x 84”W and 96”W Rectangle or Racetrack Table Tops • Two bases shipped in separate cartons | HFXB29A HFXB29B HFXB29AN | 40 53 80 | 16.1 16.1 32.2 | \$650 \$687 \$1300 | \$670 \$707 \$1340 |
|  | Base X-Style — For 18”H Tables For 30” and 36” Round or Square Table Tops | HFXB17B | 37 | 3.0 | \$560 | \$580 |
|  | Base Disc Style — For 29½”H Tables For 30” Round or Square Table Tops For 36” Round or Square Table Tops Use with 33”D x 72”W x 84”W and 96”W Rectangle or Racetrack Table Tops • Two bases shipped in separate cartons | HFDB29A HFDB29B HFDB29AN | 40 56 80 | 16.1 16.1 32.2 | \$650 \$687 \$1300 | \$660 \$707 \$1320 |
|  | Base X-Style — For 41”H Standing-Height Tables • Use with 33”D x 72”W, 84”W and 96”W Rectangle or Racetrack Table Tops • Two bases shipped in separate cartons | HFXB42AN | 84 | 36.4 | \$1364 | \$1404 |
| | Base X-Style — For 41”H Standing-Height Tables For 30” Round or Square Table Tops For 36” Round or Square Table Tops | HFXB42A HFXB42B | 42 55 | 18.2 16.1 | \$682 \$720 | \$702 \$740 |
|  | Base Disc Style — For 41”H Standing-Height Tables • Use with 33”D x 72”W, 84”W and 96”W Rectangle or Racetrack table tops, when a Footring is not desired • Two bases shipped in separate cartons | HFDB42AN | 92 | 19.0 | \$1322 | \$1362 |
| | Base Disc Style — For 41”H Standing-Height Tables For 30” Round or Square Table Tops For 36” Round or Square Table Tops | HFDB42A HFDB42B | 46 62 | 9.5 13.5 | \$661 \$702 | \$681 \$722 |
|  | Base Disc Style with Footring — For 41”H Standing-Height Tables For 30” Round or Square Table Tops For 36” Round or Square Table Tops Use with 33”D x 72”W x 84”W and 96”W Rectangle or Racetrack Table Tops • Two bases shipped in separate cartons | HFDB42AF HFDB42BF HFDB42AFN | 56 68 112 | 9.5 13.5 32.2 | \$857 \$898 \$1714 | \$877 \$918 \$1754 |
|  | Base Disc Style with Footring — For 41”H Standing-Height Tables For 33”D x 96”W Rectangle or Racetrack Table Tops For 33”D x 84”W Rectangle or Racetrack Table Tops For 33”D x 72”W Rectangle or Racetrack Table Tops NOTES: Includes two bases and a single oval footring that spans both tables. Two bases and footring shipped in three separate cartons. | HFDB42AF96 HFDB42AF84 HFDB42AF72 | 121 123 125 | 19.7 19.8 19.9 | \$1980 \$1916 \$1882 | \$2020 \$1956 \$1922 |

NOTES:
 • Each base includes adjustable leveling glides.

HOW TO SPECIFY

| | |
|---------------------------------------|---|
| Select Model Number HFTB17N | Select Paint Color PR8 Textured Silver P7A Textured Charcoal |
|---------------------------------------|---|



FLOCK® Collaborative Tables

| | DESCRIPTION | MODEL | SHIP WEIGHT | CUBE | L1 LIST PRICE | L2 UPCHARGE |
|---|--|-----------------|-------------|------|---------------|-------------|
|  | Laminated Personal Table 18" Dia. x 25"H | HFTPTL18 | 36 | 4.5 | \$675 | \$12 |

HOW TO SPECIFY

| | | | |
|---|---|--|---|
| Select Model Number H F T P T L 1 8 | Select Edge Detail G 2mm Edge Select Edge Color See page 45 G K | Select Laminate Top Color See page 45 H | Select Base Paint Color PR8 Textured Silver P7A Textured Charcoal P R 8 |
|---|---|--|---|

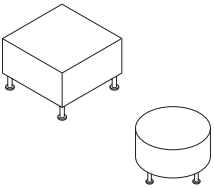
| | DESCRIPTION | MODEL | SHIP WEIGHT | CUBE | L1 LIST PRICE | L2 UPCHARGE |
|---|---|----------------------------------|-------------|------------|------------------------------|----------------------------|
|  | Laminated Collaborative Cube and Cylinder Tables 24" Laminated Cube Table — 24"W x 24"D x 17 1/8"H 26" Laminated Cylinder Table — 26" Dia. x 17 1/8"H | HFTLS24 HFTLD26 | 44 39 | 5.0 5.0 | \$811 \$744 | \$30 \$30 |
| | NOTES: Accessory port quantity and configuration on tables should correspond to the accessories planned for the table. For grommet and port information, see page 46. | | | | | |

NOTES:

- Accessory port options on the collaborative cube and cylinder tables allow for tablet accessory to be added.
- For grommet and port information, see page 46.
- HGRMTAC and HGRMTDATA on page 51 can also be used with Flock® tables.
- Standard Leg (L) can be adjusted for leveling.
- For a complete line of compatible Flock® collaborative seating solutions, please see pages 284-307.

HOW TO SPECIFY

| | | | | | |
|---|---|--|--|---|--|
| Select Model Number H F T L S 2 4 | Select Grommet Option See page 46 for Grommet placement N No Grommet G Round Grommet — centered (\$15 upcharge) | Select Accessory Port Option See page 46 for Port placement 0 No Port 1 One Corner Port 2 Two Ports — Opposite (\$10 upcharge per port) | Select Laminate See page 45 H | Select Leg Option L Standard Leg Leg Options TR Tapered Round Leg TS Tapered Square Leg | Select Paint Color PR8 Textured Silver P7A Textured Charcoal P R 8 |
|---|---|--|--|---|--|

FLOCK® Collaborative Tables

GSA SIN AS NOTED



Icon Legend on page 17

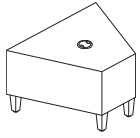

Shown with Round Grommet

OPEN MARKET

DESCRIPTION

Laminate Wedge Table
22.17"W x 29.43"D x 17"H

MODEL

HFTLW45

SHIP WEIGHT

34

CUBE

7.7

L1 LIST PRICE

\$774

L2 UPCHARGE

\$30

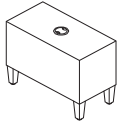

Shown with Round Grommet

OPEN MARKET

Laminate Rectangle Table
24"W x 12"D x 17"H

HFTLR12

29

3.9

\$540

\$20



SIN 33721

Laminate Tablet Accessory
14" Dia. x 10"H from table top

HFTTAL14

6

2.5

\$402

\$15

NOTES: Use with Collaborative Cube and Cylinder tables for additional workspace. Attaches to tables through ports. Multiple port location options are available. Tablet pivots/swivels toward the user.

NOTES:









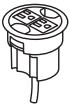
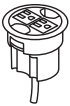

- Accessory Port options on the Collaborative Cube and Cylinder Tables allow for Tablet Accessory to be added.
- For grommet and port information, see page 46.
- HGRMTAC and HGRMTDATA on page 51 can also be used with Flock® tables.
- Standard Leg (L) can be adjusted for leveling.
- For a complete line of compatible Flock® collaborative seating solutions, please see pages 284-307.

HOW TO SPECIFY

| | | | | | |
|--|--|---|---|--|--|
| <p>Select Model Number</p> <p>HFTLW45</p> | <p>Select Grommet Option</p> <p>See page 46 for Grommet placement</p> <p>N No Grommet G Round Grommet — centered (\$15 upcharge)</p> <p>N</p> | <p>Select Accessory Port Option</p> <p>See page 46 for Port placement</p> <p>O No Port</p> <p>O</p> | <p>Select Laminate Top Color</p> <p>See page 45</p> <p>N</p> | <p>Select Leg Option</p> <p>L Standard Leg Leg Options TR Tapered Round Leg TS Tapered Square Leg</p> <p>TS</p> | <p>Select Paint Color</p> <p>PR8 Textured Silver P7A Textured Charcoal</p> <p>P7A</p> |
|--|--|---|---|--|--|

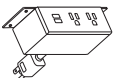
| | | | |
|---|--|---|--|
| <p>Select Model Number</p> <p>HFTTAL14</p> | <p>Select Edge Detail</p> <p>G 2mm Edge</p> <p>Select Edge Color</p> <p>See page 45</p> <p>GK</p> | <p>Select Laminate Top Color</p> <p>See page 45</p> <p>H</p> | <p>Select Paint Color</p> <p>PR8 Textured Silver P7A Textured Charcoal</p> <p>PR8</p> |
|---|--|---|--|

FLOCK® Collaborative Accessories

| | DESCRIPTION | MODEL | SHIP WEIGHT | CUBE | LIST PRICE |
|---|---|--|--|------|------------------------------|
|  | Power Hub, 3" Grommet Mount, 6' Cord <ul style="list-style-type: none"> Fits in 3" round grommet holes Field installed with Plug-and-play ease Two grounded AC power outlets Includes 6' cord with three-prong plug Available in Black only. <i>Specify X when ordering. Example: HGRMTAC.X.</i> NOTES: For additional information see page 204. | HGRMTAC | 1.3 | 0.2 | \$126 |
|  | 3" Round Power Grommet – 2 Outlets, 10' Cord <ul style="list-style-type: none"> Includes 10' cord with three-prong plug. Fits in 3" round grommet holes. Two grounded AC power outlets. Field installed with Plug-and-play ease. NOTES: For additional information see page 204.  Available in black finish only, no specification needed. | HGRMTAC2 | 1.5 | 0.2 | \$159 |
|  | Power/USB Hub, 3" Grommet Mount <ul style="list-style-type: none"> One grounded AC power outlet with 2 USB ports UL Listed NOTES: For additional information see page 204.  Available in black only (no color designation so use .X – Specify: HGRMTUSB2.X). | HGRMTUSB2 | 1.3  | 0.2 | \$250 |
|  | Data Grommet <p>Blank grommet kit that includes adapters for a variety of manufacturers jacks and couplers.</p> <ul style="list-style-type: none"> Fits in existing 3" round grommet housing Available in Black only. <i>Specify P when ordering. Example: HGRMTDATA.P.</i> NOTES: For additional information see page 204. | HGRMTDATA | 0.2 | 0.2 | \$23 |
|  | Power Modules <p>3 Receptacles with Under-Worksurface Mounting Bracket</p> <p>2 Receptacles 2 USB with Under-Worksurface Mounting Bracket</p> <ul style="list-style-type: none"> 6' power cord with standard three-prong plug. Under-worksurface mounting bracket models work with any top that has a 5" x 5" square clearance. Worksurface clamp models work on any top with a 4" overhang. UL Listed. NOTES: For additional information see page 205.  Finish choices coordinate with HON's Charcoal or Designer White. <i>Specify STRM for Storm or SNW for Snow. Example: HPWRMOD3UWM.SNW.</i> | HPWRMOD3UWM HPWRMOD2UWM | 2.3  2.3  | 0.2 | \$342 \$546 |

SIN 33721

Model HPWRMOD2UWM shown

SIN 33721

HUDDLE

Want to see more? Scan here
to check out hon.com.



Huddle Tables shown with Motivate® Seating.

HUDDLE

These sturdy, versatile tables link and unlink to quickly transform a space. Temporary workstation? Done. Impromptu conference table? Easy! Training session? No problem. Huddle helps you maximize time and square footage — not costs. And for today's businesses, that's a nice change of pace.



FEATURES

- 1½" thick solid core top is made from durable high-performance particleboard.
- Heavy-grade, warp-resistant particleboard tops and bases withstand heavy activity.
- Mobile nesting base option lets tables fold up and roll away until you need them.
- Choose wiring and power options so Huddle tables are ready to work when you are.
- Modesty panels offer the added level of privacy your employees want.
- Two edge profiles in over 20 colors and patterns to accommodate differing tastes.
- Height adjustable laptop table offers a mobile, personal table for working anywhere.

HUDDLE ORDERING INFORMATION

LAMINATE

TOPS/L1 LAMINATES CODES

- Woodgrain**
- ◆ Bourbon Cherry H
 - ◆ Cognac COGN
 - ◆ Florence Walnut LFW1
 - ◆ Harvest C
 - ◆ Kingswood Walnut LK11
 - ◆ Mahogany N
 - ◆ Mocha MOCH
 - ◆ Natural Maple D
 - ◆ Pinnacle PINC
 - ◆ Shaker Cherry F
 - ◆ Sterling Ash LSA1
- Solid**
- ◆ Black P
 - ◆ Charcoal S
 - ◆ Designer White LDW1
 - ◆ Loft LOFT
- Patterned**
- ◆ Handspun Chestnut LAHC
 - ◆ Handspun Dove LAHD
 - ◆ Handspun Pearl LAHP
 - ◆ Handspun Slate LAHS
 - ◆ Sheer Mesh * A5
 - ◆ Silver Mesh B9
 - ◆ Steel Mesh * A9
 - ◆ Canyon Zephyr * K9
 - ◆ Desert Zephyr * K8
 - ◆ Shadow Zephyr * K1
 - ◆ Battleship LBTT*
 - ◆ Gray G2
 - ◆ Grey Tigris * L6
 - ◆ Moroccan LMN1*
 - ◆ Mushroom LMH1*
 - ◆ Neon Carrot LNC1*
 - ◆ Tennis Ball LTB1*
 - ◆ White G1
 - ◆ Whitestone * K4

TOPS/L2 LAMINATES CODES

- Woodgrain**
- ◆ Lowell Ash LLA1
 - ◆ Natural Recon LNR1
 - ◆ Phantom Ecru LPE1
 - ◆ Portico Teak LPT1
 - ◆ Skyline Walnut LSW1

EDGE BAND

EDGES/ EDGE BAND (2MM) CODES

- ◆ Black P
- ◆ Bourbon Cherry H
- ◆ Brownstone EY
- ◆ Charcoal S
- ◆ Cognac COGN
- ◆ Designer White DW
- ◆ Florence Walnut FW
- ◆ Fossil EH
- ◆ Greige R
- ◆ Harvest C
- ◆ Kingswood Walnut KI
- ◆ Loft LOFT
- ◆ Lowell Ash DL
- ◆ Mahogany N
- ◆ Mocha MOCH
- ◆ Muslin T
- ◆ Natural Maple D
- ◆ Natural Recon NR
- ◆ Phantom Ecru PE
- ◆ Pinnacle PINC
- ◆ Platinum K
- ◆ Portico Teak DP
- ◆ Shadow * SHDW
- ◆ Shaker Cherry F
- ◆ Skyline Walnut SW
- ◆ Sterling Ash SA

T-MOLD

T-MOLD CODES

- ◆ Atom AT*
- ◆ Black P
- ◆ Brownstone EY
- ◆ Bullseye BY*
- ◆ Charcoal S*
- ◆ Designer White DW
- ◆ Ember MR*
- ◆ Fossil EH
- ◆ Greige R
- ◆ Ion IO*
- ◆ Iris IR*
- ◆ Krypton KT*
- ◆ Loft LOFT
- ◆ Lowell Ash DL
- ◆ Muslin T
- ◆ Natural Recon NR
- ◆ Phantom Ecru PE
- ◆ Platinum K
- ◆ Portico Teak DP
- ◆ Regatta RE*
- ◆ Shadow * SHDW
- ◆ Skyline Walnut SW

PAINT

BASE PAINT CODES

- P1**
- ◆ Black P
 - ◆ Brownstone P7D
 - ◆ Charcoal S
 - ◆ Designer White PJW
 - ◆ Fossil P28
 - ◆ Greige T5
 - ◆ Light Gray Q
 - ◆ Loft LOFT
 - ◆ Muslin T3
 - ◆ Putty L
 - ◆ Shadow * SHDW
 - ◆ Titanium P8T
- P2**
- ◆ Champagne Metallic T4
 - ◆ Platinum Metallic T1
 - ◆ Silver PR6
- P3**
- ◆ Atom P8S
 - ◆ Bullseye PJF
 - ◆ Ember P8P
 - ◆ Ion P8N
 - ◆ Iris P8J
 - ◆ Krypton P8F
 - ◆ Regatta P8M

Recommended Edgeband Color Selection:

| Laminate | | Edge | |
|------------------|------|------------------|------|
| Bourbon Cherry | H | Bourbon Cherry | H |
| Cognac | COGN | Cognac | COGN |
| Florence Walnut | LFW1 | Florence Walnut | FW |
| Harvest | C | Harvest | C |
| Kingswood Walnut | LK11 | Kingswood Walnut | KI |
| Mahogany | N | Mahogany | N |
| Mocha | MOCH | Mocha | MOCH |
| Natural Maple | D | Natural Maple | D |
| Pinnacle | PINC | Pinnacle | PINC |
| Shaker Cherry | F | Shaker Cherry | F |
| Sterling Ash | LSA1 | Sterling Ash | SA |
| Black | P | Black | P |
| Charcoal | S | Charcoal | S |
| Designer White | LDW1 | Designer White | DW |
| Loft | LOFT | Loft | LOFT |
| Whitestone | K4 | Muslin | T |
| Sheer Mesh | A5 | Muslin | T |
| Silver Mesh | B9 | Loft | LOFT |
| Steel Mesh | A9 | Charcoal | S |
| Canyon Zephyr | K9 | Greige | R |
| Desert Zephyr | K8 | Greige | R |
| Shadow Zephyr | K1 | Loft | LOFT |
| Gray | G2 | Charcoal | S |
| Grey Tigris | L6 | Greige | R |
| White | G1 | Charcoal | S |
| Lowell Ash | LLA1 | Lowell Ash | DL |
| Natural Recon | LNR1 | Natural Recon | NR |
| Phantom Ecru | LPE1 | Phantom Ecru | PE |
| Portico Teak | LPT1 | Portico Teak | DP |
| Skyline Walnut | LSW1 | Skyline Walnut | SW |

* Available on Laptop Table only.

◆◆◆ For lead time information see page 17.

* De-emphasized

HUDDLE

Multi-Purpose Tables

Huddle Multi-Purpose Tables are ready to jump into action for training, meetings, collaboration and more. Thoughtful design, flexibility and plenty of base, edge and finish options, make Huddle tables capable of meeting the needs of smart, agile businesses.

Tops - Rectangle

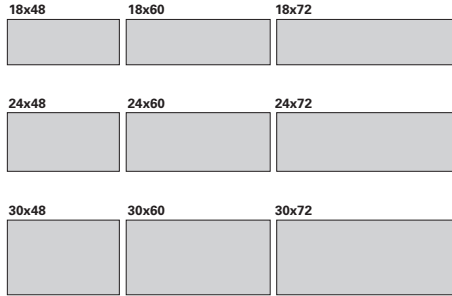

Edge Options

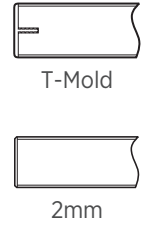

Tops - Half-Round and Extended Half-Round

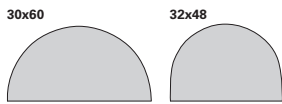

Bases

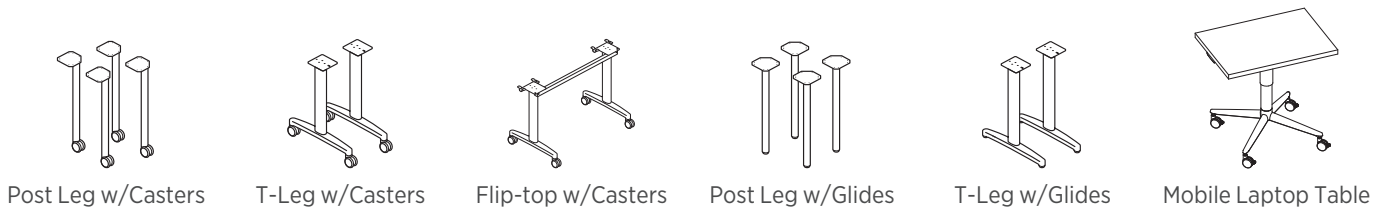

Accessories

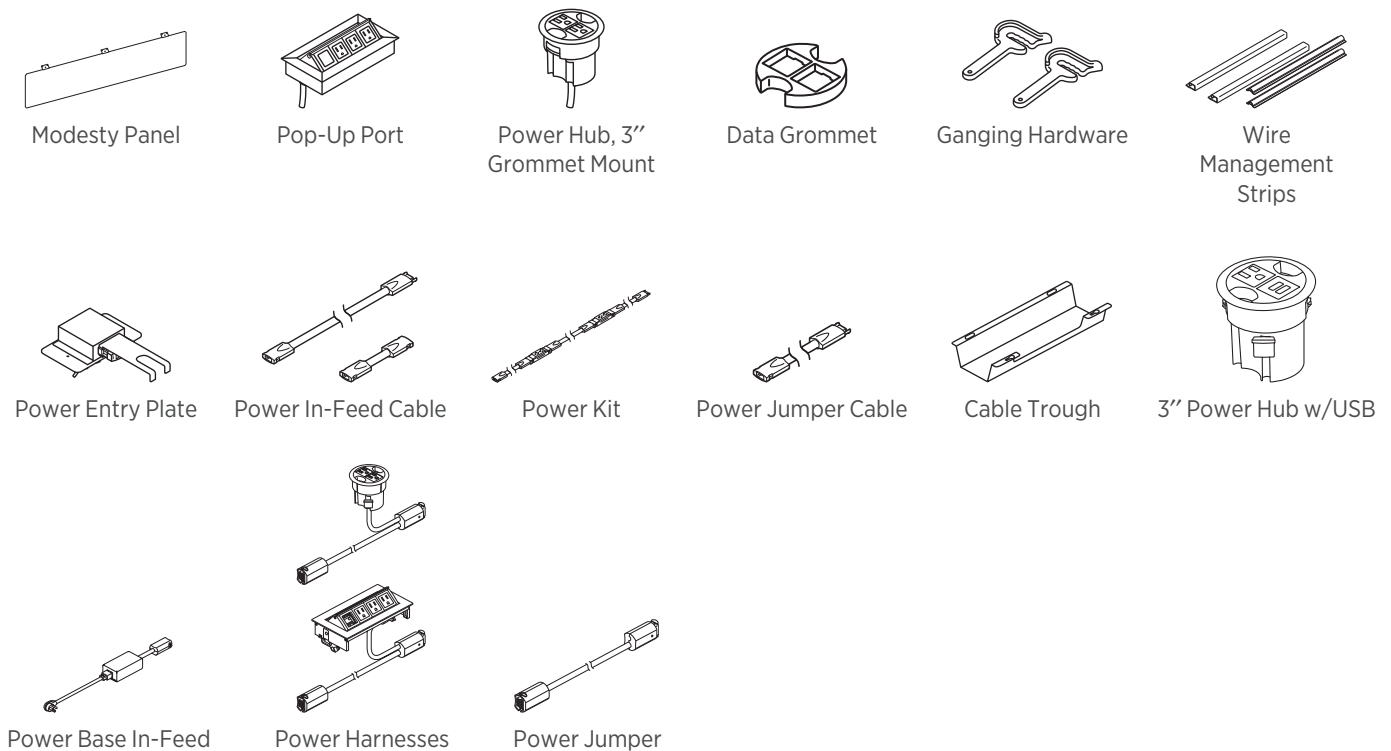



Icon Legend on page 17

HUDDLE Typicals

| QTY | DESCRIPTION | MODEL | LIST PRICE | PRICE EXTENSION |
|---------------|--------------------------------------|--------------|------------|-----------------|
| 12 | Rectangular Table Top 60"W x 24"D | HMT2460G | \$419 | \$5,028 |
| 12 | Flip-top Base | HMBFLIP24L.C | \$675 | \$8,100 |
| 21 | Perpetual® Nesting Chair | HPN1 | \$774 | \$16,254 |
| TOTAL: | | | | \$29,382 |

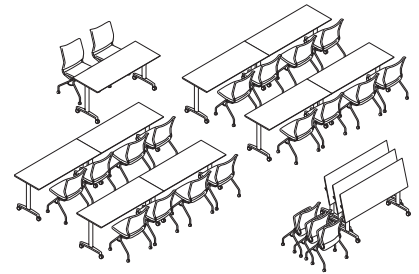

TRAINING

| QTY | DESCRIPTION | MODEL | LIST PRICE | PRICE EXTENSION |
|---------------|--------------------------------------|----------|------------|-----------------|
| 4 | Rectangular Table Top 72"W x 30"D | HMT3072G | \$494 | \$1,976 |
| 4 | Post Leg Base | HMBPOST | \$388 | \$1,552 |
| 8 | Perpetual® Nesting Chair | HPN1 | \$774 | \$6,192 |
| TOTAL: | | | | \$9,720 |

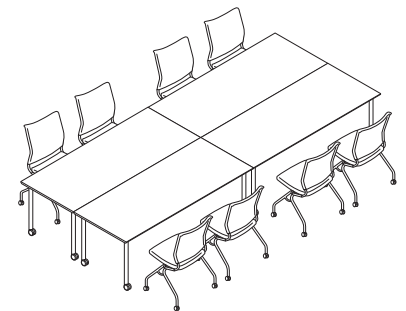

MEETING/CONFERENCE

| QTY | DESCRIPTION | MODEL | LIST PRICE | PRICE EXTENSION |
|---------------|--------------------------------------|------------|------------|-----------------|
| 2 | Rectangular Table Top 72"W x 30"D | HMT3072G | \$494 | \$988 |
| 2 | Half-round Table Top | HMTHR3060G | \$475 | \$950 |
| 2 | Flip-top Base | HMBFLIP30L | \$675 | \$1,350 |
| 2 | Flip-top Base | HMBFLIP24S | \$675 | \$1,350 |
| 4 | Perpetual® Nesting Chair | HPN1 | \$774 | \$3,096 |
| TOTAL: | | | | \$7,734 |

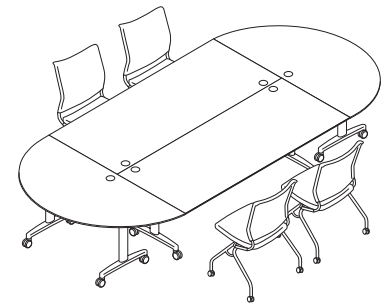

MEETING

HUDDLE Typicals



Icon Legend on page 17

| QTY | DESCRIPTION | MODEL | LIST PRICE | PRICE EXTENSION |
|---------------|--------------------------------------|-------------|------------|-----------------|
| 8 | Rectangular Table Top 60"W x 30"D | HMT3060G | \$433 | \$3,464 |
| 8 | Fixed Height T-Leg Base with Casters | HMBTLEG24.C | \$459 | \$3,672 |
| 8 | Perpetual® Nesting Chair | HPN1 | \$774 | \$6,192 |
| TOTAL: | | | | \$13,328 |

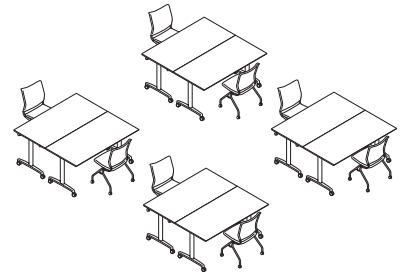

GROUP BREAKOUT

| QTY | DESCRIPTION | MODEL | LIST PRICE | PRICE EXTENSION |
|---------------|--------------------------------------|-------------|------------|-----------------|
| 6 | Rectangular Table Top 72"W x 24"D | HMT2472G | \$464 | \$2,784 |
| 6 | Fixed Height T-Leg Base with Casters | HMBTLEG24.C | \$459 | \$2,754 |
| 12 | Perpetual® Nesting Chair | HPN1 | \$774 | \$9,288 |
| TOTAL: | | | | \$14,826 |

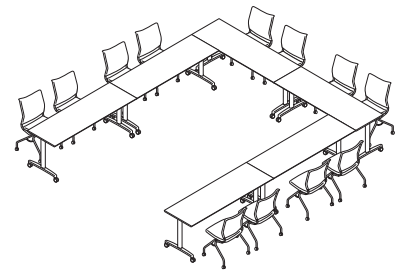

PRESENTATION

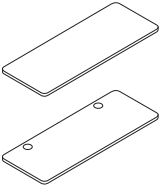
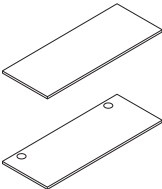

HUDDLE Multi-Purpose Table Tops

| | DESCRIPTION | MODEL | SHIP WEIGHT | CUBE | LIST PRICE BY LAMINATE GRADE | | |
|---|---|--|-------------|------|------------------------------|-------|-------|
| | | | | | L1 | L2 | |
|  <p>HMT1848E</p> | Rectangular T-Mold Table Tops | | | | | | |
| | 48"W x 18"D | HMT1848E | 34 | 2.9 | \$337 | \$347 | |
| | 60"W x 18"D | HMT1860E | 42 | 3.5 | \$358 | \$373 | |
| | 72"W x 18"D | HMT1872E | 51 | 3.9 | \$440 | \$455 | |
| | 48"W x 24"D | HMT2448E | 45 | 3.7 | \$379 | \$394 | |
| | 60"W x 24"D | HMT2460E | 57 | 4.5 | \$419 | \$439 | |
| | 72"W x 24"D | HMT2472E | 68 | 5.0 | \$464 | \$484 | |
| | 48"W x 30"D | HMT3048E | 57 | 4.4 | \$395 | \$410 | |
| | 60"W x 30"D | HMT3060E | 71 | 5.4 | \$433 | \$453 | |
| | 72"W x 30"D | HMT3072E | 85 | 6.0 | \$494 | \$514 | |
| |  <p>HMT1848G</p> | Rectangular Edgeband Table Tops | | | | | |
| | | 48"W x 18"D | HMT1848G | 34 | 2.9 | \$337 | \$347 |
| 60"W x 18"D | | HMT1860G | 42 | 3.5 | \$358 | \$373 | |
| 72"W x 18"D | | HMT1872G | 51 | 3.9 | \$440 | \$455 | |
| 48"W x 24"D | | HMT2448G | 45 | 3.7 | \$379 | \$394 | |
| 60"W x 24"D | | HMT2460G ⓘ | 57 | 4.5 | \$419 | \$439 | |
| 72"W x 24"D | | HMT2472G | 68 | 5.0 | \$464 | \$484 | |
| 48"W x 30"D | | HMT3048G | 57 | 4.4 | \$395 | \$410 | |
| 60"W x 30"D | | HMT3060G | 71 | 5.4 | \$433 | \$453 | |
| 72"W x 30"D | | HMT3072G | 85 | 6.0 | \$494 | \$514 | |

NOTES:

- Table tops are 1/8" thick.
- When post legs are used with 18"D tops, post leg to be specified with glides only.
- ⓘ Round grommets available in Black only.
- ⓘ Pop-up Port option (G1) is unfinished. Insert accessory must be ordered separately.

HOW TO SPECIFY

| | | | |
|---|--|---|---|
| <p>Select Model Number</p> <p>HMT1848G</p> | <p>Select Grommet Option</p> <p>N No Grommet G 2 Grommets (Black only) (\$30 upcharge) G1 Cutout for Pop-up Port (\$40 upcharge). Order port separately.</p> <p>N</p> | <p>Select Laminate</p> <p>See page 53</p> <p>D</p> | <p>Select Edge Color</p> <p>See page 53</p> <p>D</p> |
|---|--|---|---|

HUDDLE

Multi-Purpose Table Tops

GSA SIN 33721

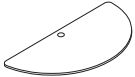
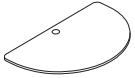
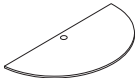
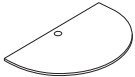

Icon Legend on page 17

| | DESCRIPTION | MODEL | SHIP WEIGHT | CUBE | LIST PRICE BY LAMINATE GRADE | |
|--|---|-------------------|-------------|------|------------------------------|--------------|
| | | | | | L1 | L2 |
|  HMTHR3060E | Half-Round and Extended Half-Round T-Mold Table Tops 60"W x 30"D, Half-Round Table Tops (use bases: HMBFLIP24S or HMBTLEG24 or HMBPOST) | HMTHR3060E | 69 | 6.1 | \$475 | \$495 |
| | 48"W x 32"D, Extended Half-Round Table Tops (use bases: HMBFLIP24S or HMBTLEG24) | HMTHR3248E | 57 | 6.1 | \$464 | \$484 |
|  HMTHR3248E | | | | | | |
| | | | | | | |
|  HMTHR3060G | Half-Round and Extended Half-Round Edgeband Table Tops 60"W x 30"D, Half-Round Table Tops (use bases: HMBFLIP24S or HMBTLEG24 or HMBPOST) | HMTHR3060G | 69 | 6.1 | \$475 | \$495 |
| | 48"W x 32"D, Extended Half-Round Table Tops (use bases: HMBFLIP24S or HMBTLEG24) | HMTHR3248G | 57 | 6.1 | \$464 | \$484 |
|  HMTHR3248G | | | | | | |
| | | | | | | |

NOTES:

- Table tops are 1½" thick.
- ❗ Round grommets available in Black only.
- ❗ Pop-up Port option (G1) is unfinished. Insert accessory must be ordered separately.

HOW TO SPECIFY

| | | | |
|--|--|---|---|
| <p>Select Model Number</p> <p>H M T H R 3 2 4 8 G .</p> | <p>Select Grommet Option</p> <p>N No Grommet G 1 Grommet (Black only) (\$15 upcharge) G1 Cutout for Pop-up Port (\$40 upcharge). Order port separately.</p> <p>N .</p> | <p>Select Laminate</p> <p>See page 53</p> <p>D .</p> | <p>Select Edge Color</p> <p>See page 53</p> <p>D</p> |
|--|--|---|---|



HUDDLE

Multi-Purpose Table Bases





| | DESCRIPTION | MODEL | SHIP WEIGHT | CUBE | LIST PRICE BY PAINT GRADE | | |
|---|--|--|-------------|--------------|------------------------------|------------------------------|------------------------------|
| | | | | | P1 | P2 | P3 |
|  | Fixed Height T-Leg Base (Includes 2 T-legs) | | | | | | |
| | For 18"D Table Tops For 24"D and 30"D Table Tops | HMBTLEG18 HMBTLEG24  | 12 14 | 3.6 3.6 | \$459 \$459 | \$479 \$479 | \$489 \$489 |
|  | Flip-top Base (Includes 1 Complete Base) | | | | | | |
| | For 18"D x 48"W Rectangular Table Tops | HMBFLIP18S | 23 | 4.1 | \$675 | \$695 | \$705 |
| | For 18"D x 60"W, 72"W Rectangular Table Tops | HMBFLIP18L | 26 | 4.1 | \$675 | \$695 | \$705 |
| | For 24"D x 48"W and 32"D x 48"W Rectangular Table Tops and 30"D x 60"W Half-Round Table Tops | HMBFLIP24S | 24 | 4.1 | \$675 | \$695 | \$705 |
| | For 24"D x 60"W, 72"W Rectangular Table Tops | HMBFLIP24L  | 27 | 4.1 | \$675 | \$695 | \$705 |
| | For 30"D x 48"W Rectangular Table Tops For 30"D x 60"W, 72"W Rectangular Table Tops | HMBFLIP30S HMBFLIP30L | 24 27 | 4.1 4.1 | \$675 \$675 | \$695 \$695 | \$705 \$705 |
|  | Post Leg Base (Includes 4 Post Legs) | | | | | | |
| For all Tops | HMBPOST | 18 | 2.3 | \$388 | \$408 | \$418 | |

Table Top to Base Compatibility Chart:

| | Flip-Top | T-Leg | Post Leg |
|----------------|------------|-----------|----------|
| 18"D x 48"W | HMBFLIP18S | HMBTLEG18 | HMBPOST* |
| 18"D x 60"W | HMBFLIP18L | HMBTLEG18 | HMBPOST* |
| 18"D x 72"W | HMBFLIP18L | HMBTLEG18 | HMBPOST* |
| 24"D x 48"W | HMBFLIP24S | HMBTLEG24 | HMBPOST |
| 32"D x 48"W HR | HMBFLIP24S | HMBTLEG24 | N/A |
| 30"D x 60"W HR | HMBFLIP24S | HMBTLEG24 | HMBPOST |
| 24"D x 60"W | HMBFLIP24L | HMBTLEG24 | HMBPOST |
| 24"D x 72"W | HMBFLIP24L | HMBTLEG24 | HMBPOST |
| 30"D x 48"W | HMBFLIP30S | HMBTLEG24 | HMBPOST |
| 30"D x 60"W | HMBFLIP30L | HMBTLEG24 | HMBPOST |
| 30"D x 72"W | HMBFLIP30L | HMBTLEG24 | HMBPOST |

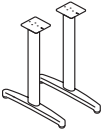
*Post legs should be specified with glides for use on 18"D worksurfaces.

NOTE: Glides/casters are NOT interchangeable on Post Leg and T-base.

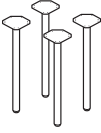
NOTES:

- When glides are specified, adjustable range is 1".
- Flip-top base is standard with casters.
- When post legs are used with 18"D tops, post leg to be specified with glides only.

HOW TO SPECIFY

| | | |
|---|---|---|
| Select Model Number <div style="border: 1px solid black; padding: 2px; display: flex; gap: 5px;"> HMBTLEG18 </div> | Select Glide/Caster Option G Glide C Caster Flip-top base is available with casters only When post legs are used with 18"D tops, specify with glides only <div style="border: 1px solid black; padding: 2px; display: flex; gap: 5px;"> G </div> | Select Paint Color See page 53 \$20 upcharge per model, for P2 paint \$30 upcharge per model, for P3 paint <div style="border: 1px solid black; padding: 2px; display: flex; gap: 5px;"> T1 </div> |
|---|---|---|

HUDDLE

Mobile Laptop Table

GSA SIN 33721



Icon Legend on page 17



| DESCRIPTION | MODEL | SHIP WEIGHT | CUBE | LIST PRICE | UPCHARGE BY LAMINATE/PAINT GRADE | | | |
|------------------------------|-------------------|-------------|------|--------------|----------------------------------|-------------|-------------|-------------|
| | | | | | L2 | L5 | P2 | P3 |
| T-Mold 28"W x 20"D | HPHAP2028E | 59 | 8.7 | \$873 | \$20 | \$80 | \$20 | \$30 |



| | | | | | | | | |
|--------------------------------|-------------------|----|-----|--------------|-------------|-------------|-------------|-------------|
| Edgeband 28"W x 20"D | HPHAP2028G | 59 | 8.7 | \$873 | \$20 | \$80 | \$20 | \$30 |
|--------------------------------|-------------------|----|-----|--------------|-------------|-------------|-------------|-------------|

NOTES:



- Tables adjust from 26"-33"H.
- Pneumatic height adjustment so no electricity is required to adjust height of table.

HOW TO SPECIFY

| | | | |
|---|--|--|--|
| <p>Select Model Number</p> <p>HPHAP2028E</p> | <p>Select Laminate</p> <p>See page 53</p> <p>LFW1</p> | <p>Select Edge Color</p> <p>See page 53</p> <p>FW</p> | <p>Select Paint Color</p> <p>See page 53</p> <p>P8T</p> |
|---|--|--|--|

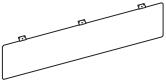

HUDDLE Table Accessories

| | DESCRIPTION | MODEL | SHIP WEIGHT | CUBE | LIST PRICE BY PAINT GRADE | | |
|---|---|------------------|-------------|------|---------------------------|-------|-------|
| | | | | | P1 | P2 | P3 |
|  | Universal Modesty Panel For 48"W Huddle Tables | HMTUMOD32 | 9 | 1.9 | \$232 | \$252 | \$262 |
| | For 60"W & 72"W Huddle Tables | HMTUMOD44 | 12 | 2.5 | \$253 | \$273 | \$283 |
| NOTES: Universal Modesty Panels nest between the table legs. | | | | | | | |
|  | Ganging Hardware • Includes two ganging links and two screws • No color designator when specifying. <i>Example: HMAGANG.</i> | HMAGANG | 1 ☉ | 0.1 | \$102 | | |

NOTES:

- Ganging Hardware must be ordered and installed on tables when using 4-trac electrical systems.
- Ganging hardware attaches to underside of table in pre-drilled pilot holes.
- Vertical Wire Management Strips must be trimmed when applied to legs of T-Leg and Flip-Top Bases with casters.

HOW TO SPECIFY

| | |
|--|---|
| Select Model Number <input type="text" value="HMTUMOD32"/> | Select Paint Color <input type="text" value="S"/> |
|--|---|

CABLE MANAGEMENT

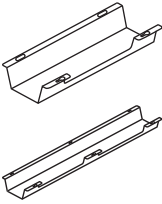
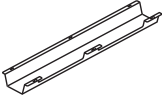
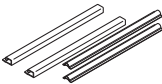
| | DESCRIPTION | MODEL | SHIP WEIGHT | CUBE | LIST PRICE |
|--|--|---------------------|-------------|------|------------|
|  | Cable Management Troughs 17"W — Single | HCTROUGH17 | 3 ☉ | 0.5 | \$73 |
| | 17"W — 10-Pack | HCTROUGH1710 | 14 ☉ | 0.5 | \$665 |
|  | 36"W — Single | HCTROUGH36 | 5 ☉ | 0.9 | \$122 |
| | 36"W — 10-Pack | HCTROUGH3610 | 30 ☉ | 0.9 | \$1121 |
| • Metal Cable Management Troughs ship flat • Troughs attach to underside of worksurface with screws • Cutouts in trough allow access to power without the need to detach from surface. 17"W = 1 cutout; 36"W = 2 cutouts. • Graphite only, no need to specify • Slim profile design NOTES: For additional information see page 208. | | | | | |
|  SIN 33721 | Wire Management Strips Includes: 2 - 24" vertical strips 2 - 24" horizontal strips • Available in Black only. <i>Specify P when ordering. Example: HBTMS.P.</i> • HON 5-Year Limited Warranty. | HBTMS | 3 ☉ | 0.2 | \$126 |
| OPEN MARKET | | | | | |



HOW TO SPECIFY

| |
|---|
| Select Model Number <input type="text" value="HCTROUGH17"/> |
|---|

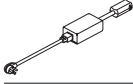

Icon Legend on page 17

INTERLINK IQ ELECTRICAL

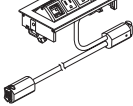
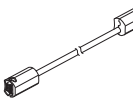
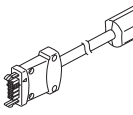
| | DESCRIPTION | MODEL | SHIP WEIGHT | CUBE | LIST PRICE |
|--|---|--------------------|-------------|------|--------------|
|  | Power Base In-Feed • 12 amp circuit breaker is built in to the Power Base In-Feed. • Available in Black finish, no specification needed. | HQB | 2 | 0.2 | \$566 |
|  | Power Harness – 1' Power Hub, 3'' Round Grommet Mount • Available in Black finish, no specification needed. | HQH1-3 | 2 | 0.2 | \$186 |
|  | Power Harness – 5' Power Hub, 3'' Round Grommet Mount • Available in Black finish, no specification needed. | HQH5-3 | 2 | 0.2 | \$208 |
|  | Power Harness – 5' with 4'' x 8'' Pop-Up Port (3 Power, 1 Blank) • For use with tables G1 grommet. Specify paint. | HQH5-P-3P1B | 3 | 0.3 | \$408 |
|  | Power Jumper – 3' • Available in Black finish, no specification needed. | HQJ3 | 2 | 0.2 | \$117 |
|  | IQ 1.0 Backward Compatible Jumper 36'' • Available in Black finish, no specification needed. • Use when connecting Interlink IQ 1.0 power harness (rectangle end) to Interlink IQ 2.0 (oval end) power harness. ! If using Interlink IQ 2.0 in-feed with Interlink IQ 1.0 power harness please contact Customer Support. | HQBCJ36 | 2 | 0.2 | \$89 |

Specification guide for IQ Electrical on Huddle tables

Determine table width, the type of power access being used (3" grommet or 4x8 pop-up) and the desired number per table (Columns 1, 2 or 3). The table will then identify the type and quantity of components needed per table along with the maximum table run. Note that this is in addition to the Power base in-feed which is needed for each run. For example, a 48"W table with two 3" power grommets per table will require (1) HQH5-3 harness and (1) HQH1-3 harness per table with a maximum run of four tables.

| Top Width | POWER ONE (1) PER TABLE 3" ROUND POWER GROMMET | | POWER TWO (2) PER TABLE 3" ROUND POWER GROMMETS | | POWER ONE (1) PER TABLE 4x8 POP-UP PORT | |
|------------------------|---|------------------------|--|--------------------|--|--------------------|
| | Quantity | Table Run Maximum | Quantity | Table Run Maximum | Quantity | Table Run Maximum |
| 36" | (1) HQH5-3 | 8 | N/A | N/A | (1) HQH5-P | 8 |
| 42" | (1) HQH5-3 | 8 | N/A | N/A | (1) HQH5-P | 8 |
| 48" | (1) HQH5-3 | 8 | (1) HQH5-3 (1) HQH1-3 | 4 Max Table Run | (1) HQH5-P | 8 Max Table Run |
| 54" | (1) HQH5-3 | 8 | (1) HQH5-3 (1) HQH1-3 | 4 Max Table Run | (1) HQH5-P | 8 Max Table Run |
| 60" | (1) HQH5-3 | 8 | (1) HQH5-3 (1) HQH1-3 | 4 Max Table Run | (1) HQH5-P | 8 Max Table Run |
| 66" | (1) HQH5-3 (1) HQJ3 | 4 Table Run Maximum | (1) HQH5-3 (1) HQH1-3 | 4 Max Table Run | (1) HQH5-P (1) HQJ3 | 4 Max Table Run |
| 72" | (1) HQH5-3 (1) HQJ3 | 4 Table Run Maximum | (1) HQH5-3 (1) HQH1-3 | 4 Max Table Run | (1) HQH5-P (1) HQJ3 | 4 Max Table Run |
| 84" | (1) HQH5-3 (1) HQJ3 | 4 Table Run Maximum | (2) HQH5-3 | 4 Max Table Run | (1) HQH5-P (1) HQJ3 | 4 Max Table Run |
| 96" | (1) HQH5-3 (1) HQJ3 | 4 Table Run Maximum | (2) HQH5-3 | 4 Max Table Run | (1) HQH5-P (1) HQJ3 | 4 Max Table Run |
| Half-Round (all sizes) | (1) HQH1-3 | 2 Tables Maximum | N/A | N/A | (1) HQH5-P | 2 Max Table Run |
| Trapezoid (all sizes) | (1) HQH5-3 | 8 Table Run Maximum | N/A | N/A | (1) HQH5-P | 8 Max Table Run |

NOTES:

- Interlink IQ Electrical is a pluggable, single circuit electrical system.
- All electrical models include wire management clips and hardware.
- Interlink IQ Electrical is non-sequential/non-directional. It can be installed in any direction.
- Interlink IQ Electrical is UL Recognized as a Powered Table System and meets the requirements of UL 962.

! 40' maximum run, or no more than 8 units, whichever comes first. Interlink IQ system will automatically shut off if maximum requirements are exceeded. Maximum run is based upon electrical harness width, not table width.

HOW TO SPECIFY

Select Model Number

H Q H 5 - P - 3 P 1 B .

Select Paint Color

FOG Fog
SVR Silver
BLK Black

S V R

4-TRAC HARDWIRE ELECTRICAL SYSTEM

4-Trac Electrical System

The 4-Trac Electrical System is a UL-recognized Manufactured Wiring System that seamlessly passes power from one worksurface to another. This low-profile non-sequential electrical system allows tables to be “daisy-chained” together in any desired order and allows users to reconfigure quickly due to simple connectable/disconnectable links.

- Meets requirements of UL 183 and National Electric Code Article 604
- 4-Wires, 2-circuits, 20 Amps each (Circuit 1 and Circuit 2 only)
- 13 Duplex Receptacles per circuit, 26, 15 Amp Duplex receptacle per power in-feed
- Electrical system attaches directly to underside of worksurface with included brackets
- Up to twelve tables can be linked together

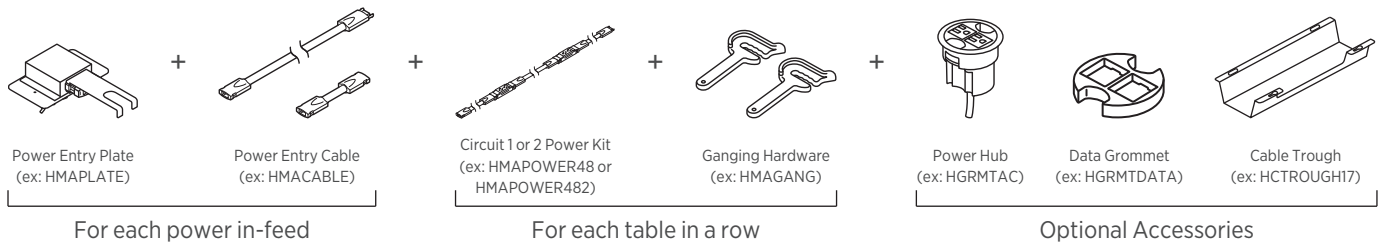



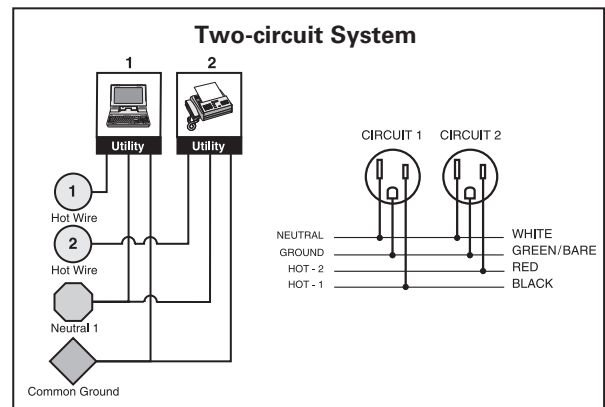
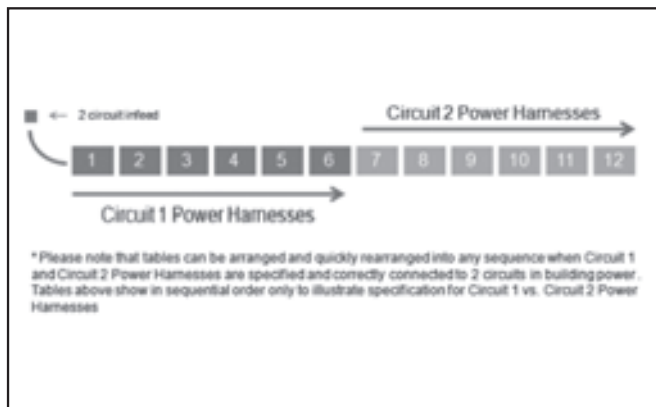

Steps for Electrical Specifications:

- Determine how many rows of tables are needed and order the following:
 - One HMAPLATE per row (or power in-feed)
 - One HMACABLE per row (or power in-feed)
- Order one power harness per table in each row
 - For 1-6 tables in a row (see illustration 1)
 - Order Circuit 1 Power Harnesses (ex. If powering six 24x60 tables order six sets of HMAPOWER60)
 - For 7-12 tables in a row (see illustration 1)
 - Order Circuit 1 Power Harness for first six tables and Circuit 2 Power Harness for remaining tables (ex. If powering eight 24x60 tables, order six sets of HMAPOWER60 and two sets of HMAPOWER602)
- Order one set of ganging hardware per table (ex. HMAGANG)
- Determine which accessories are needed:
 - Power Hub model HGRMTAC — to access power at worksurface.
 - Data Grommet model HGRMTDATA — to access data at worksurface.
 - Wire Management strips model HBTMS — for vertical and horizontal wire management.

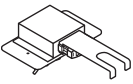
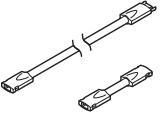

4-TRAC HARDWIRE ELECTRICAL SYSTEM

| | DESCRIPTION | MODEL | SHIP WEIGHT | CUBE | LIST PRICE |
|---|--|--------------------|-------------|--------------|--------------|
|  | Power Entry Plate | HMAPLATE | 1.0 | 0.2 | \$102 |
|  | Power Entry Cable • 6' power entry cable with male/female adapter. • Connects table to power entry plate. | HMACABLE | 1.8 | 0.2 | \$159 |
|  | Power Jumper Cable To connect tables front to front | HMAJUMP | 0.5 | 0.3 | \$54 |
|  | Circuit 1 Power Kit for 48" W Table | HMAPOWER48 | 1.8 | 0.3 | \$294 |
| | Circuit 1 Power Kit for 60" W Table | HMAPOWER60 | 2.0 | 0.3 | \$302 |
| | Circuit 1 Power Kit for 72" W Table | HMAPOWER72 | 2.2 | 0.3 | \$309 |
| | Circuit 1 Power Kit for 84" W Table | HMAPOWER84 | 2.4 | 0.3 | \$320 |
| | Circuit 1 Power Kit for 96" W Table | HMAPOWER96 | 2.6 | 0.3 | \$331 |
| | Circuit 2 Power Kit for 48" W Table | HMAPOWER482 | 1.8 | 0.3 | \$294 |
| Circuit 2 Power Kit for 60" W Table | HMAPOWER602 | 2.0 | 0.3 | \$302 | |
| Circuit 2 Power Kit for 72" W Table | HMAPOWER722 | 2.2 | 0.3 | \$309 | |
| Circuit 2 Power Kit for 84" W Table | HMAPOWER842 | 2.4 | 0.3 | \$320 | |
| Circuit 2 Power Kit for 96" W Table | HMAPOWER962 | 2.6 | 0.3 | \$331 | |
|  | Electrical Connectors 4-Way Splitter ! Available in Black (P) only. SPECIFYING EXAMPLE: HMASPLIT.P | HMASPLIT | 0.9 | 0.1 | \$55 |

NOTES:

- Ganging Hardware must be ordered and installed on tables when using 4-trac electrical systems. See page 61 for Ganging Hardware.
- Each power kit includes two duplex receptacles and attaches to the underside of the worksurface with included brackets.



HOW TO SPECIFY

Select
Model Number

HMAPLATE

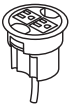
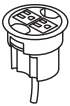

HUDDLE Power and Cable Management

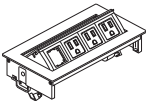
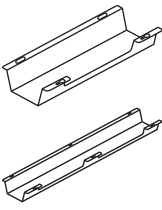
| | DESCRIPTION | MODEL | SHIP WEIGHT | CUBE | LIST PRICE |
|--|--|--|--------------------------|--|--------------|
|  SIN 33721T | Power Hub, 3" Grommet Mount, 6' Cord <ul style="list-style-type: none"> Fits in 3" round grommet holes. Field installed with Plug-and-play ease. Two grounded AC power outlets. Includes 6' cord with three-prong plug. Available in Black only. <i>Specify X when ordering. Example: HGRMTAC.X.</i> NOTES: For additional information see page 204. | HGRMTAC | 1.3 | 0.2 | \$126 |
|  SIN 33721T | 3" Round Power Grommet - 2 Outlets, 10' Cord <ul style="list-style-type: none"> Includes 10' cord with three-prong plug. Fits in 3" round grommet holes. Two grounded AC power outlets. Field installed with Plug-and-play ease. NOTES: Power Modules will also work with standing-height applications for 10500 Series™ and Voi® desks. ! Available in black finish only, no specification needed. | HGRMTAC2 | 1.5 | 0.2 | \$159 |
|  SIN 33721T | Power/USB Hub, 3" Grommet Mount <ul style="list-style-type: none"> One grounded AC power outlet with 2 USB ports. UL Listed. NOTES: For additional information see page 204. ! Available in black only (no color designation so use .X - Specify: HGRMTUSB2.X). | HGRMTUSB2 | 1.3 | 0.2 | \$250 |
|  SIN 33721 | Data Grommet Blank grommet kit that includes adapters for a variety of manufacturers jacks and couplers. <ul style="list-style-type: none"> Fits in existing 3" round grommet housing. Available in Black only. <i>Specify P when ordering. Example: HGRMTDATA.P.</i> NOTES: For additional information see page 204. | HGRMTDATA | 0.2 | 0.2 | \$23 |
|  SIN 33721 | MhoB 4" x 8" Pop-up Port <ul style="list-style-type: none"> Specify G1 cutout in table top. Pop-up Port provides three power ports and one blank data receptacle. Sits flush with worksurface when closed. Includes 6' cord with three-prong plug. | HTG1PWR-3P-1B | 5.0 | 0.3 | \$424 |
|  SIN 33721 | Cable Management Troughs 17"W - Single 17"W - 10-Pack 36"W - Single 36"W - 10-Pack <ul style="list-style-type: none"> Cable management troughs ship flat packed. The troughs attach to underneath the worksurface with screws. Cutouts in trough allow access to power without the need to detach from surface. 17"W = 1 cutout; 36"W = 2 cutouts. Color: Graphite. NOTES: For additional information see page 208. | HCTROUGH17 2.7 HCTROUGH1710 14.0 HCTROUGH36 4.9 HCTROUGH3610 30.0 | 0.5 0.5 0.9 0.9 | \$73 \$665 \$122 \$1121 | |

HOW TO SPECIFY

Select Model Number

H G R M T A C

Select Model Number

H T G 1 P W R - 3 P - 1 B .

Select Paint Color

FOG Fog
SVR Silver
BLK Black

S V R

OCCASIONAL TABLES

Want to see more? Scan here
to check out hon.com.



Occasional Tables shown with Ceres® Seating.

OCCASIONAL TABLES

Durable materials and construction make HON Occasional Tables ideal for high-traffic areas such as lobbies, reception areas and lounges. The versatile design also dresses up any corner of the executive office where casual, but important, conversations are held. Use them to hold lamps, magazines and more. They're available in 14 woodgrain, patterned or solid color laminates to coordinate with any decor.



FEATURES

- A high-quality solution for any organization wanting to make a great impression on clients and visitors.
- Scratch-, spill- and stain-resistant laminate stands up to heavy use.
- Heavy-grade, warp-resistant particleboard features high recycled content.
- Complement many interiors and furniture designs.
- Brings people together comfortably in reception areas, lounges and offices.

LAMINATE OCCASIONAL TABLES OPTIONS

H80191, H80192, H80193

L1 LAMINATES CODES

Woodgrain

- ◆ Bourbon Cherry H
- ◆ Cognac COGN
- ◆ Florence Walnut LFW1
- ◆ Harvest C
- ◆ Kingswood Walnut LK11
- ◆ Mahogany N
- ◆ Mocha MOCH
- ◆ Natural Maple D
- ◆ Pinnacle PINC
- ◆ Shaker Cherry F
- ◆ Sterling Ash LSA1

Solid

- ◆ Black P
- ◆ Charcoal S
- ◆ Designer White LDW1
- ◆ Loft LOFT

Patterned Top*

- ◆ Grey Tigris * L6
- ◆ Handspun Chestnut LAHC
- ◆ Handspun Dove LAHD
- ◆ Handspun Pearl LAHP
- ◆ Handspun Slate LAHS
- ◆ Sheer Mesh * A5
- ◆ Silver Mesh A9
- ◆ Canyon Zephyr * K9
- ◆ Desert Zephyr * K8

H80170, H80180

L1 LAMINATES CODES

Woodgrain

- ◆ Bourbon Cherry H
- ◆ Cognac COGN
- ◆ Florence Walnut LFW1
- ◆ Harvest C
- ◆ Kingswood Walnut LK11
- ◆ Mahogany N
- ◆ Mocha MOCH
- ◆ Natural Maple D
- ◆ Pinnacle PINC
- ◆ Shaker Cherry F
- ◆ Sterling Ash LSA1

Solid

- ◆ Black P
- ◆ Charcoal S
- ◆ Designer White LDW1
- ◆ Loft LOFT

Two-Tone Options for Laminate Occasional Tables (H80191, H80192 and H80193)

| | |
|---|--|
| Black/Charcoal (PS) | Handspun Pearl/Fossil (LAHP/EH) |
| Black/Designer White (PLDW1) | Handspun Slate/Charcoal (LAHS/S) |
| Bourbon Cherry/Black (HP) | Harvest/Black (CP) |
| Bourbon Cherry/Charcoal (HS) | Harvest/Charcoal (CS) |
| Bourbon Cherry/Designer White (HLDW1) | Harvest/Designer White (CLDW1) |
| Charcoal/Black (SP) | Kingswood Walnut/Black (LK11P) |
| Charcoal/Designer White (SLDW1) | Kingswood Walnut/Charcoal (LK11S) |
| Cognac/Black (COGNP) | Kingswood Walnut/Designer White (LK11LDW1) |
| Cognac/Charcoal (COGNS) | Kingswood Walnut/Loft (LK11LOFT) |
| Cognac/Designer White (COGNLDW1) | Mahogany/Black (NP) |
| Designer White/Black (LDW1P) | Mahogany/Charcoal (NS) |
| Designer White/Bourbon Cherry (LDW1H) | Mahogany/Designer White (NLDW1) |
| Designer White/Charcoal (LDW1S) | Mocha/Black (MOCHP) |
| Designer White/Cognac (LDW1COGN) | Mocha/Charcoal (MOCHS) |
| Designer White/Harvest (LDW1C) | Mocha/Designer White (MOCHLDW1) |
| Designer White/Mahogany (LDW1N) | Natural Maple/Black (DP) |
| Designer White/Mocha (LDW1MOCH) | Natural Maple/Charcoal (DS) |
| Designer White/Natural Maple (LDW1D) | Natural Maple/Designer White (DLDW1) |
| Designer White/Pinnacle (LDW1PINC) | Pinnacle/Black (PINCP) |
| Designer White/Shaker Cherry (LDW1F) | Pinnacle/Charcoal (PINCS) |
| Florence Walnut/Black (LFW1P) | Pinnacle/Designer White (PINCLDW1) |
| Florence Walnut/Charcoal (LFW1S) | Shaker Cherry/Black (FP) |
| Florence Walnut/Designer White (LFW1LDW1) | Shaker Cherry/Charcoal (FS) |
| Florence Walnut/Loft (LFW1LOFT) | Shaker Cherry/Designer White (FLDW1) |
| Handspun Chestnut/Loft (LAHC/LOFT) | Sterling Ash/Black (LSA1P) |
| Handspun Dove/Fossil (LAHD/EH) | Sterling Ash/Charcoal (LSA1S) |
| | Sterling Ash/Designer White (LSA1LDW1) |

* NOTE: For patterned top laminates, select one of the following for the edgeband around the top, apron, and legs — Black (P), Bourbon Cherry (H), Charcoal (S), Cognac (COGN), Designer White (LDW1), Florence Walnut (LFW1), Harvest (C), Kingswood Walnut (LK11), Mahogany (N), Mocha (MOCH), Natural Maple (D), Pinnacle (PINC), Shaker Cherry (F), Sterling Ash (LSA1).

◆◆◆ For lead time information see page 17.







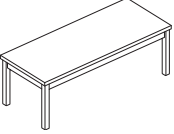

* De-emphasized

LAMINATE Occasional Tables

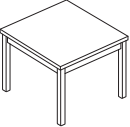
GSA SIN 33721

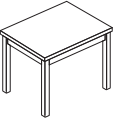

Icon Legend on page 17

| | DESCRIPTION | MODEL | SHIP WEIGHT | CUBE | LIST PRICE |
|--|--|---------------|--|------|--------------|
|   | Coffee Table 48"W x 20"D x 16"H | H80191 | 48  | 3.4 | \$541 |
|   | Corner Table 24"W x 24"D x 20"H | H80192 | 35  | 2.1 | \$466 |
|   | End Table 24"W x 20"D x 20"H | H80193 | 29  | 1.8 | \$445 |
|  | Cylinder Table 20" Diameter x 20"H | H80170 | 40 | 6.2 | \$728 |
|  | Cube Table 24"W x 24"D x 20"H | H80180 | 55 | 8.6 | \$788 |

NOTES:

- Durable material and construction make laminate occasional tables ideal for high traffic areas such as lobbies, reception rooms and lounges. Versatile design is also well suited to private offices.
- Coffee, Corner and End Tables feature top-over-apron styling with square corner detail, which complements many interiors and furniture designs, including the 10500 Series.
- Tables accommodate lamps, magazines, plants, laptops and more.
- Tops are abrasion- and stain-resistant laminate over 1/8" thick solid core high-performance particleboard.
- Cylinder and cube tables have recessed black plinth base with tack glides. Tops and sides are covered with high-pressure laminate.



H80191, H80192, H80193
Edge Detail

HOW TO SPECIFY

| | |
|--|---|
| <p>Select Model Number</p> <p>H 8 0 1 9 1 .</p> | <p>Select Laminate</p> <p>See page 67 for Select Laminate noted with each model</p> <p>N N</p> |
|--|---|



LAMINATE Contemporary Occasional Tables

| | DESCRIPTION | MODEL | SHIP WEIGHT | CUBE | LIST PRICE |
|---|--|----------------|-------------|------|--------------|
|  | Laminat Corner Table 24"W x 24"D x 17½"H | HML8851 | 24 | 1.7 | \$216 |
|  | Laminat Coffee Table 48"W x 24"D x 15½"H | HML8852 | 38 | 3.1 | \$270 |

- NOTES:**
- Silver frame.
 - **HON 5-Year Limited Warranty.**
 - ! Metal leg occasional tables available in Black laminate ONLY.

HOW TO SPECIFY

| | |
|----------------------------|------------------------|
| Select Model Number | Select Laminate |
| H M L 8 8 5 1 . | P Black |
| | P |

| | DESCRIPTION | MODEL | SHIP WEIGHT | CUBE | LIST PRICE |
|---|---|-----------------|-------------|------|--------------|
|  | Coffee Table 42"W x 20"D x 16"H | HBLH3160 | 24 | 3.0 | \$321 |
|  | Corner Table 24"W x 24"D x 20"H | HBLH3170 | 9 | 1.7 | \$250 |

- NOTES:**
- Square Edge Detail (Laminate)



 - **HON 5-Year Limited Warranty.**
 - Ideal for reception areas, lounges and offices.
 - Laminate tops have a hollow core honeycomb substructure, making them extremely lightweight.
 - 2" thick top.
 - Sleek contemporary design.
 - Models HBLH3160 and HBLH3170 available in Black finish only.

HOW TO SPECIFY

| | |
|----------------------------|------------------------|
| Select Model Number | Select Laminate |
| H B L H 3 1 6 0 . | P Black |
| | P |

MOTIVATE®

Want to see more? Scan here
to check out hon.com.



Motivate® Tables, Chairs, and Presentation Tools.

MOTIVATE®

Motivate tables were designed with flexible spaces in mind. Work patterns can change throughout the day. Task areas become collaborative areas. Learning areas become conference areas. Created for HON by designer Wolfgang Deisig, Motivate tables are mobile, lightweight and ready to support the many ways you work — adapting and reacting to your needs with ease. Because flexible spaces make for dynamic workplaces.



FEATURES

- 1½" thick solid core top is made from durable high-performance particleboard.
- Motivate Tables are available in three base options — fixed, nesting and height adjustable.
- Optional modular power can be ganged together without any tools.
- Motivate Tables coordinate perfectly with Motivate chairs — an ideal fit for flexible spaces.
- Add a mobile presentation cart or markerboard for increased function and productivity in your workspace.
- Available in multiple top shapes, edge types, and bases with a variety of laminate and paint finish options.

MOTIVATE® TABLES SPECIFYING INFORMATION

LAMINATE

L1 LAMINATES CODES

- Woodgrain**
- ◆ Bourbon Cherry H
 - ◆ Cognac COGN
 - ◆ Florence Walnut LFW1
 - ◆ Harvest C
 - ◆ Kingswood Walnut LK11
 - ◆ Mahogany N
 - ◆ Mocha MOCH
 - ◆ Natural Maple D
 - ◆ Pinnacle PINC
 - ◆ Shaker Cherry F
 - ◆ Sterling Ash LSA1
- Solid**
- ◆ Black P
 - ◆ Charcoal S
 - ◆ Designer White LDW1
 - ◆ Loft LOFT
- Patterned**
- ◆ Handspun Chestnut LAHC
 - ◆ Handspun Dove LAHD
 - ◆ Handspun Pearl LAHP
 - ◆ Handspun Slate LAHS
 - ◆ Sheer Mesh * A5
 - ◆ Silver Mesh B9
 - ◆ Steel Mesh * A9
 - ◆ Canyon Zephyr * K9
 - ◆ Desert Zephyr * K8
 - ◆ Shadow Zephyr * K1
 - ◆ Gray G2
 - ◆ White G1
 - ◆ Whitestone * K4

L2 LAMINATES CODES

- Woodgrain**
- ◆ Lowell Ash LLA1
 - ◆ Natural Recon LNR1
 - ◆ Phantom Ecu LPE1
 - ◆ Portico Teak LPT1
 - ◆ Skyline Walnut LSW1

EDGE BAND

EDGE BAND 2mm CODES

- ◆ Black P
- ◆ Bourbon Cherry H
- ◆ Brownstone EY
- ◆ Charcoal S
- ◆ Cognac COGN
- ◆ Designer White DW
- ◆ Florence Walnut FW
- ◆ Fossil EH
- ◆ Greige R
- ◆ Harvest C
- ◆ Kingswood Walnut KI
- ◆ Loft LOFT
- ◆ Lowell Ash DL
- ◆ Mahogany N
- ◆ Mocha MOCH
- ◆ Muslin T
- ◆ Natural Maple D
- ◆ Natural Recon NR
- ◆ Phantom Ecu PE
- ◆ Pinnacle PINC
- ◆ Platinum K
- ◆ Portico Teak DP
- ◆ Shadow * SHDW
- ◆ Shaker Cherry F
- ◆ Skyline Walnut SW
- ◆ Sterling Ash SA

ERGO

ERGO-EDGE CODES

- ◆ Black P
- ◆ Platinum K

PAINT

PAINT CODES

- P1**
- ◆ Black P
 - ◆ Brownstone P7D
 - ◆ Charcoal S
 - ◆ Designer White PJW
 - ◆ Fossil P28
 - ◆ Greige T5
 - ◆ Loft LOFT
 - ◆ Muslin T3
 - ◆ Putty L
 - ◆ Textured Black BLCK
 - ◆ Textured Platinum Metallic PLAT
 - ◆ Titanium P8T
- P2**
- ◆ Champagne Metallic T4
 - ◆ Platinum Metallic T1
 - ◆ Silver PR6
 - ◆ Solar Black P8X
 - ◆ Textured Silver P8B
- P3**
- ◆ Atom P8S
 - ◆ Bullseye PJF
 - ◆ Ember P8P
 - ◆ Ion P8N
 - ◆ Iris P8J
 - ◆ Krypton P8F
 - ◆ Regatta P8M

Recommended Edgeband Color Selection:

| Laminate | | Edgeband | |
|------------------|------|------------------|------|
| Bourbon Cherry | H | Bourbon Cherry | H |
| Cognac | COGN | Cognac | COGN |
| Florence Walnut | LFW1 | Florence Walnut | FW |
| Harvest | C | Harvest | C |
| Kingswood Walnut | LK11 | Kingswood Walnut | KI |
| Mahogany | N | Mahogany | N |
| Mocha | MOCH | Mocha | MOCH |
| Natural Maple | D | Natural Maple | D |
| Pinnacle | PINC | Pinnacle | PINC |
| Shaker Cherry | F | Shaker Cherry | F |
| Sterling Ash | LSA1 | Sterling Ash | SA |
| Black | P | Black | P |
| Charcoal | S | Charcoal | S |
| Designer White | LDW1 | Designer White | DW |
| Whitestone | K4 | Muslin | T |
| Sheer Mesh | A5 | Muslin | T |
| Silver Mesh | B9 | Loft | LOFT |
| Steel Mesh | A9 | Charcoal | S |
| Canyon Zephyr | K9 | Greige | R |
| Desert Zephyr | K8 | Greige | R |
| Shadow Zephyr | K1 | Loft | LOFT |
| Gray | G2 | Charcoal | S |
| White | G1 | Charcoal | S |
| Lowell Ash | LLA1 | Lowell Ash | DL |
| Natural Recon | LNR1 | Natural Recon | NR |
| Phantom Ecu | LPE1 | Phantom Ecu | PE |
| Portico Teak | LPT1 | Portico Teak | DP |
| Skyline Walnut | LSW1 | Skyline Walnut | SW |
| Loft | LOFT | Loft | LOFT |

◆◆◆ For lead time information see page 17.

* De-emphasized

MOTIVATE® Fixed Height Tables

GSA SIN 33721



Icon Legend on page 17



| DESCRIPTION | MODEL | SHIP WEIGHT | CUBE | LIST PRICE BY LAMINATE GRADE | | | |
|---------------------------------------|------------------|-------------|------|------------------------------|--------|---------------|--------|
| | | | | "G" 2MM EDGE | | "R" ERGO EDGE | |
| | | | | L1 | L2 | L1 | L2 |
| Rectangular Tables, Fixed Base | | | | | | | |
| 72"W x 18"D | HMVR-1872(?) -FX | 80 | 6.6 | \$1031 | \$1046 | \$1365 | \$1380 |
| 60"W x 18"D | HMVR-1860(?) -FX | 70 | 6.0 | \$949 | \$964 | \$1238 | \$1253 |
| 48"W x 18"D | HMVR-1848(?) -FX | 54 | 5.3 | \$940 | \$950 | \$1200 | \$1210 |
| 96"W x 24"D | HMVR-2496(?) -FX | 118 | 8.8 | \$1320 | \$1345 | N/A | N/A |
| 84"W x 24"D | HMVR-2484(?) -FX | 109 | 8.1 | \$1266 | \$1291 | N/A | N/A |
| 72"W x 24"D | HMVR-2472(?) -FX | 96 | 7.3 | \$1053 | \$1073 | \$1403 | \$1423 |
| 66"W x 24"D | HMVR-2466(?) -FX | 90 | 7.3 | \$1032 | \$1052 | N/A | N/A |
| 60"W x 24"D | HMVR-2460(?) -FX | 83 | 6.6 | \$1009 | \$1029 | \$1326 | \$1346 |
| 54"W x 24"D | HMVR-2454(?) -FX | 71 | 6.6 | \$990 | \$1010 | N/A | N/A |
| 48"W x 24"D | HMVR-2448(?) -FX | 65 | 5.8 | \$968 | \$983 | \$1253 | \$1268 |
| 42"W x 24"D | HMVR-2442(?) -FX | 60 | 5.4 | \$947 | \$962 | N/A | N/A |
| 36"W x 24"D | HMVR-2436(?) -FX | 54 | 5.1 | \$931 | \$946 | N/A | N/A |
| 96"W x 30"D | HMVR-3096(?) -FX | 145 | 10.7 | \$1428 | \$1453 | N/A | N/A |
| 84"W x 30"D | HMVR-3084(?) -FX | 131 | 10.7 | \$1415 | \$1440 | N/A | N/A |
| 72"W x 30"D | HMVR-3072(?) -FX | 115 | 9.8 | \$1146 | \$1166 | \$1519 | \$1539 |
| 66"W x 30"D | HMVR-3066(?) -FX | 108 | 9.8 | \$1115 | \$1135 | N/A | N/A |
| 60"W x 30"D | HMVR-3060(?) -FX | 100 | 8.9 | \$1087 | \$1107 | \$1429 | \$1449 |
| 54"W x 30"D | HMVR-3054(?) -FX | 87 | 8.9 | \$1066 | \$1086 | N/A | N/A |
| 48"W x 30"D | HMVR-3048(?) -FX | 80 | 7.9 | \$1052 | \$1067 | \$1351 | \$1366 |
| 42"W x 30"D | HMVR-3042(?) -FX | 73 | 7.4 | \$1026 | \$1041 | N/A | N/A |
| 36"W x 30"D | HMVR-3036(?) -FX | 65 | 6.9 | \$1005 | \$1020 | N/A | N/A |
| 72"W x 36"D | HMVR-3672(?) -FX | 131 | 10.8 | \$1312 | \$1337 | N/A | N/A |
| 60"W x 36"D | HMVR-3660(?) -FX | 114 | 9.7 | \$1217 | \$1242 | N/A | N/A |
| 48"W x 36"D | HMVR-3648(?) -FX | 91 | 9.7 | \$1137 | \$1157 | N/A | N/A |
| Half-Round Tables, Fixed Base | | | | | | | |
| 72"W x 36"D | HMVH-3672(?) -FX | 103 | 10.8 | \$1367 | \$1392 | N/A | N/A |
| 60"W x 30"D | HMVH-3060(?) -FX | 75 | 7.6 | \$1066 | \$1091 | \$1430 | \$1455 |
| 48"W x 24"D | HMVH-2448(?) -FX | 56 | 5.8 | \$996 | \$1016 | \$1303 | \$1323 |
| Trapezoid Tables, Fixed Base | | | | | | | |
| 72"W x 36"D | HMVT-3672(?) -FX | 91 | 10.8 | \$1389 | \$1414 | N/A | N/A |
| 60"W x 30"D | HMVT-3060(?) -FX | 66 | 7.6 | \$1075 | \$1100 | \$1446 | \$1471 |
| 48"W x 24"D | HMVT-2448(?) -FX | 56 | 5.8 | \$1015 | \$1035 | \$1325 | \$1345 |

NOTES:

- Specification includes top and base, however, top and base are boxed separately.
- Ergo edge is a bullnose on user side and 3mm on all other sides.
- Tops are 1 1/8" thick.
- Fixed Height base is standard 29 1/2" seated-height.
- See grommet matrix on page 77 for grommet location/placement.
- 36"-42" tops and all half-round and trapezoid tops standard with one 3" round grommet, 48"-96" tops standard with two 3" round grommets. When G1 grommet is selected, all tops standard with one cutout.

Edge Treatments

- HOW TO ORDER
 - 1) Select desired model numbers.
 - 2) Select desired top edge treatment.
 - 3) Replace the (?) after each model number with the suffix representing the chosen top edge treatment.



"G" 2mm Edge







"R" Ergo Edge

HOW TO SPECIFY

| Select Model Number | Select Grommet Option | Select Laminate | Select Edge Color | Select Caster/Glide Option | Select Base Paint Color |
|---------------------|---|-----------------|-------------------|--|--|
| N | <p>N No Grommet</p> <p>G Grommet (\$15 upcharge PER grommet)</p> <p>G1 Electrical Port (\$40 upcharge)</p> | See page 71 | See page 71 | <p>C Multi-Surface Caster</p> <p>G Glide</p> | See page 71 \$20 upcharge per model, for P2 paint |
| HMVR-1872G-FX | N | C | C | T | C |



MOTIVATE® Nesting Tables

| DESCRIPTION | MODEL | SHIP WEIGHT | CUBE | LIST PRICE BY LAMINATE GRADE | | | |
|---|-------------------------|-------------|------|------------------------------|--------|---------------|--------|
| | | | | "G" 2MM EDGE | | "R" ERGO EDGE | |
| | | | | L1 | L2 | L1 | L2 |
| Rectangular Nesting Tables | | | | | | | |
|  72"W x 18"D | HMVR-1872(?) -NS | 90 | 8.5 | \$1356 | \$1371 | \$1690 | \$1705 |
| 60"W x 18"D | HMVR-1860(?) -NS | 79 | 7.6 | \$1269 | \$1284 | \$1542 | \$1557 |
| 48"W x 18"D | HMVR-1848(?) -NS | 60 | 6.5 | \$1264 | \$1274 | \$1518 | \$1528 |
|  96"W x 24"D | HMVR-2496(?) -NS | 134 | 11.4 | \$1623 | \$1648 | N/A | N/A |
| 84"W x 24"D | HMVR-2484(?) -NS | 122 | 10.4 | \$1591 | \$1616 | N/A | N/A |
| 72"W x 24"D | HMVR-2472(?) -NS | 106 | 9.2 | \$1378 | \$1398 | \$1728 | \$1748 |
| 66"W x 24"D | HMVR-2466(?) -NS | 100 | 9.1 | \$1352 | \$1372 | N/A | N/A |
| 60"W x 24"D | HMVR-2460(?) -NS | 92 | 8.2 | \$1329 | \$1349 | \$1646 | \$1666 |
| 54"W x 24"D | HMVR-2454(?) -NS | 80 | 8.2 | \$1315 | \$1335 | N/A | N/A |
| 48"W x 24"D | HMVR-2448(?) -NS | 73 | 7.2 | \$1286 | \$1301 | \$1571 | \$1586 |
| 42"W x 24"D | HMVR-2442(?) -NS | 67 | 6.6 | \$1267 | \$1282 | N/A | N/A |
| 36"W x 24"D | HMVR-2436(?) -NS | 60 | 6.3 | \$1249 | \$1264 | N/A | N/A |
| 96"W x 30"D | HMVR-3096(?) -NS | 161 | 13.3 | \$1776 | \$1801 | N/A | N/A |
| 84"W x 30"D | HMVR-3084(?) -NS | 144 | 13.0 | \$1763 | \$1788 | N/A | N/A |
| 72"W x 30"D | HMVR-3072(?) -NS | 125 | 11.7 | \$1494 | \$1514 | \$1867 | \$1887 |
| 66"W x 30"D | HMVR-3066(?) -NS | 118 | 11.6 | \$1458 | \$1478 | N/A | N/A |
| 60"W x 30"D | HMVR-3060(?) -NS | 109 | 10.5 | \$1430 | \$1450 | \$1757 | \$1777 |
| 54"W x 30"D | HMVR-3054(?) -NS | 96 | 10.5 | \$1414 | \$1434 | N/A | N/A |
| 48"W x 30"D | HMVR-3048(?) -NS | 88 | 9.3 | \$1393 | \$1408 | \$1692 | \$1707 |
| 42"W x 30"D | HMVR-3042(?) -NS | 80 | 8.1 | \$1369 | \$1384 | N/A | N/A |
| 36"W x 30"D | HMVR-3036(?) -NS | 71 | 8.1 | \$1346 | \$1361 | N/A | N/A |
| 72"W x 36"D | HMVR-3672(?) -NS | 141 | 12.7 | \$1660 | \$1685 | N/A | N/A |
| 60"W x 36"D | HMVR-3660(?) -NS | 123 | 11.3 | \$1560 | \$1585 | N/A | N/A |
| 48"W x 36"D | HMVR-3648(?) -NS | 99 | 11.1 | \$1478 | \$1498 | N/A | N/A |
| Half-Round Nesting Tables | | | | | | | |
|  72"W x 36"D | HMVH-3672(?) -NS | 111 | 12.2 | \$1708 | \$1733 | N/A | N/A |
| 60"W x 30"D | HMVH-3060(?) -NS | 82 | 8.8 | \$1473 | \$1498 | \$1837 | \$1862 |
| 48"W x 24"D | HMVH-2448(?) -NS | 62 | 7.0 | \$1314 | \$1334 | \$1621 | \$1641 |
| Trapezoid Nesting Tables | | | | | | | |
|  72"W x 36"D | HMVT-3672(?) -NS | 98 | 12.0 | \$1732 | \$1757 | N/A | N/A |
| 60"W x 30"D | HMVT-3060(?) -NS | 72 | 8.8 | \$1393 | \$1418 | \$1749 | \$1774 |
| 48"W x 24"D | HMVT-2448(?) -NS | 57 | 7.0 | \$1342 | \$1362 | \$1643 | \$1663 |

NOTES:

- Ergo edge is a bullnose on user side and 3mm on all other sides.
- Tops are 1 1/8" thick.
- Specification includes top and base, however, top and base are boxed separately.
- See grommet matrix on page 77 for grommet location/placement.
- 36"-42" tops and all half-round and trapezoid tops standard with one 3" round grommet, 48"-96" tops standard with two 3" round grommets. When G1 grommet is selected, all tops standard with one cutout.

Edge Treatments

HOW TO ORDER

- Select desired model numbers.
- Select desired top edge treatment.
- Replace the (?) after each model number with the suffix representing the chosen top edge treatment.



"G" 2mm Edge



"R" Ergo Edge

HOW TO SPECIFY

| | | | | | |
|--|---|---|---|---|--|
| <p>Select Model Number</p> <p>HMVR-1872G-NS</p> | <p>Select Grommet Option</p> <p>N No Grommet G Grommet (\$15 upcharge PER grommet) G1 Electrical Port (\$40 upcharge)</p> <p>N</p> | <p>Select Laminate</p> <p>See page 71</p> <p>C</p> | <p>Select Edge Color</p> <p>See page 71</p> <p>C</p> | <p>Select Caster/Glide Option</p> <p>C Multi-Surface Caster G Glide</p> <p>C</p> | <p>Select Base Paint Color</p> <p>See page 71 \$20 upcharge per model, for P2 paint</p> <p>T1</p> |
|--|---|---|---|---|--|

MOTIVATE® Adjustable Height Tables

GSA SIN 33721



Icon Legend on page 17

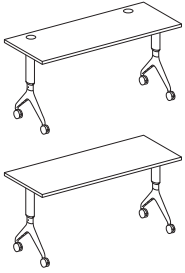

| DESCRIPTION | MODEL | SHIP WEIGHT | CUBE | LIST PRICE BY LAMINATE GRADE | | | |
|---|------------------|-------------|------|------------------------------|--------|---------------|--------|
| | | | | "G" 2MM EDGE | | "R" ERGO EDGE | |
| | | | | L1 | L2 | L1 | L2 |
| Rectangular Tables, Adjustable Height Base | | | | | | | |
| 72"W x 18"D | HMVR-1872(?) -AH | 83 | 6.6 | \$1341 | \$1356 | \$1675 | \$1690 |
| 60"W x 18"D | HMVR-1860(?) -AH | 73 | 6.0 | \$1259 | \$1274 | \$1548 | \$1563 |
| 48"W x 18"D | HMVR-1848(?) -AH | 57 | 5.3 | \$1250 | \$1260 | \$1510 | \$1520 |
| 72"W x 24"D | HMVR-2472(?) -AH | 99 | 7.3 | \$1363 | \$1383 | \$1713 | \$1733 |
| 66"W x 24"D | HMVR-2466(?) -AH | 93 | 7.3 | \$1342 | \$1362 | N/A | N/A |
| 60"W x 24"D | HMVR-2460(?) -AH | 86 | 6.6 | \$1319 | \$1339 | \$1636 | \$1656 |
| 54"W x 24"D | HMVR-2454(?) -AH | 74 | 6.6 | \$1300 | \$1320 | N/A | N/A |
| 48"W x 24"D | HMVR-2448(?) -AH | 68 | 5.8 | \$1278 | \$1293 | \$1563 | \$1578 |
| 42"W x 24"D | HMVR-2442(?) -AH | 63 | 5.4 | \$1257 | \$1272 | N/A | N/A |
| 36"W x 24"D | HMVR-2436(?) -AH | 57 | 5.1 | \$1241 | \$1256 | N/A | N/A |
| 72"W x 30"D | HMVR-3072(?) -AH | 118 | 9.8 | \$1479 | \$1499 | \$1852 | \$1872 |
| 66"W x 30"D | HMVR-3066(?) -AH | 111 | 9.8 | \$1448 | \$1468 | N/A | N/A |
| 60"W x 30"D | HMVR-3060(?) -AH | 103 | 8.9 | \$1420 | \$1440 | \$1762 | \$1782 |
| 54"W x 30"D | HMVR-3054(?) -AH | 90 | 8.9 | \$1399 | \$1419 | N/A | N/A |
| 48"W x 30"D | HMVR-3048(?) -AH | 83 | 7.9 | \$1385 | \$1400 | \$1684 | \$1699 |
| 42"W x 30"D | HMVR-3042(?) -AH | 76 | 7.4 | \$1359 | \$1374 | N/A | N/A |
| 36"W x 30"D | HMVR-3036(?) -AH | 68 | 6.9 | \$1338 | \$1353 | N/A | N/A |
| 72"W x 36"D | HMVR-3672(?) -AH | 134 | 10.8 | \$1645 | \$1670 | N/A | N/A |
| 60"W x 36"D | HMVR-3660(?) -AH | 117 | 9.7 | \$1550 | \$1575 | N/A | N/A |
| 48"W x 36"D | HMVR-3648(?) -AH | 94 | 9.7 | \$1470 | \$1490 | N/A | N/A |

NOTES:

- Ergo edge is a bullnose on user side and 3mm on all other sides.
- Tops are 1 1/8" thick.
- Specification includes top and base, however, top and base are boxed separately.
- Seated height adjustment from 27 1/2" - 32 1/2" in 1" increments.
- See grommet matrix on page 77 for grommet location/placement.
- 36"-42" tops and all half-round and trapezoid tops standard with one 3" round grommet, 48"-96" tops standard with two 3" round grommets. When G1 grommet is selected, all tops standard with one cutout.

! No tool required, adjustable bases have ratchet style adjustment mechanism.

Edge Treatments

HOW TO ORDER

- Select desired model numbers.
- Select desired top edge treatment.
- Replace the (?) after each model number with the suffix representing the chosen top edge treatment.



"G" 2mm Edge



"R" Ergo Edge

HOW TO SPECIFY

| | | | | | |
|--|---|---|---|---|---|
| <p>Select Model Number</p> <p>HMVR-1872G-AH</p> | <p>Select Grommet Option</p> <p>N No Grommet G Grommet (\$15 upcharge PER grommet) G1 Electrical Port (\$40 upcharge)</p> <p>N</p> | <p>Select Laminate</p> <p>See page 71</p> <p>C</p> | <p>Select Edge Color</p> <p>See page 71</p> <p>C</p> | <p>Select Caster/Glide Option</p> <p>C Multi-Surface Caster G Glide</p> <p>C</p> | <p>Select Base Paint Color</p> <p>See page 71 \$20 upcharge per model, for P2 paint</p> <p>P</p> |
|--|---|---|---|---|---|

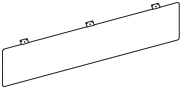

MOTIVATE® Shared Components

| DESCRIPTION | MODEL | SHIP WEIGHT | CUBE | LIST PRICE BY PAINT GRADE | |
|--|------------------|-------------|------|---------------------------|--------------|
| | | | | P1 | P2 |
|  <p>Universal Modesty Panel For 96"W Motivate® Tables For 84"W Motivate® Tables For 72"W Motivate® Tables For 66"W Motivate® Tables For 60"W Motivate® Tables For 54"W Motivate® Tables For 48"W Motivate® Tables For 42"W Motivate® Tables For 36"W Motivate® Tables</p> | HMTUMOD86 | 21 | 4.8 | \$305 | \$325 |
| | HMTUMOD74 | 20 | 4.4 | \$295 | \$315 |
| | HMTUMOD62 | 17 | 3.6 | \$284 | \$304 |
| | HMTUMOD56 | 16 | 3.4 | \$274 | \$294 |
| | HMTUMOD50 | 14 | 3.1 | \$263 | \$283 |
| | HMTUMOD44 | 12 | 2.5 | \$253 | \$273 |
| | HMTUMOD38 | 11 | 2.2 | \$241 | \$261 |
| | HMTUMOD32 | 9 | 1.9 | \$232 | \$252 |
| | HMTUMOD26 | 8 | 1.7 | \$221 | \$241 |

NOTES:

- Modesty Panels are hinged to nest along with Nesting Tables. Modesty Panels can be used with all base types.
- ! Use field installed Table Modesty Panels with all table widths 36"-96". Cannot be used with Half-Round or Trapezoid tables.

HOW TO SPECIFY

| | |
|--|--|
| <p>Select Model Number</p> <p>HMTUMOD86</p> | <p>Select Paint Color</p> <p>See page 71 \$20 upcharge per model, for P2 paint</p> <p>T1</p> |
|--|--|

MOTIVATE®

Shared Components

GSA SIN 33721 EXCEPT AS NOTED

ABI

Icon Legend on page 17

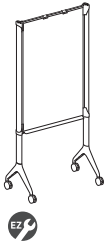
**DESCRIPTION****Mobile Markerboard**

36"W x 72"H
30"W x 72"H

Actual Markerboard size:
HMVMB-3672WW – 36¼"W x 42"H
HMVMB-3072WW – 30¼"W x 42"H

NOTES: 2-Sided Mobile Markerboard is porcelain over steel with four locking casters. Mobile Markerboard includes marker tray and flip-chart paper clips.

Porcelain Markerboard cleaning instructions: For everyday cleaning, use Clorox wipes. Use a citrus cleaner if a permanent marker is used by accident.

! A citrus cleaner is not recommended for everyday use as it leaves residue.

! \$20 list upcharge for P2 paint.

Specify Model.Base.Casters.Paint SPECIFYING EXAMPLE: HMVMB-3072WW.C.P

MODEL**SHIP WEIGHT****CUBE****LIST PRICE**

HMVMB-3672WW
HMVMB-3072WW

59
53

7.9
7.1

\$1599
\$1570

**Presentation Cart, Concave Front, Fixed Leg**

18"D x 30"W x 35"H, 2mm Edge
18"D x 30"W x 35"H, Ergo Edge

NOTES: Presentation Cart tops are 1⅝" thick with a concave user side. Choose from a 2mm or Ergo edge.

! \$10 list upcharge for L2 laminates.

Specify Model.Caster.TopLaminate.EdgeColor.Paint SPECIFYING EXAMPLE: HMVPCF-1830G.C.D.D.TI

HMVPCF-1830G
HMVPCF-1830R

38
38

3.9
3.9

\$981
\$1328

**Presentation Cart, Concave Front, Seated Height Adjustable-Leg**

18"D x 30"W x 27½"-34½"H, 2mm Edge
18"D x 30"W x 27½"-34½"H, Ergo Edge

NOTES: Presentation Cart tops are 1⅝" thick with a concave user side. Choose from a 2mm or Ergo edge.

! \$10 list upcharge for L2 laminates.

Specify Model.Caster.TopLaminate.EdgeColor.Paint SPECIFYING EXAMPLE: HMVPCA1-1830G.C.D.D.TI

HMVPCA1-1830G
HMVPCA1-1830R

40
40

3.9
3.9

\$1294
\$1656

**Presentation Cart, Concave Front, Standing-Height Adjustable-Leg**

18"D x 30"W x 31½"-38½"H, 2mm Edge
18"D x 30"W x 31½"-38½"H, Ergo Edge

NOTES: Presentation Cart tops are 1⅝" thick with a concave user side. Choose from a 2mm or Ergo edge.

! \$10 list upcharge for L2 laminates.

Specify Model.Caster.TopLaminate.EdgeColor.Paint SPECIFYING EXAMPLE: HMVPCA1-1830G.C.D.D.TI

HMVPCA2-1830G
HMVPCA2-1830R

42
42

3.9
3.9

\$1294
\$1656

**Presentation Cart, Modesty Panel**

Specify Model.Paint SPECIFYING EXAMPLE: HMVPC-MP.P

HMVPC-MP

6

1.4

\$200

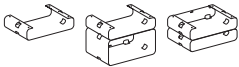
**Presentation Cart, Storage Shelves**

Single, 4" Open Back
Double, 4" Open Back / 4" Closed Back
Double, 4" Open Back / 9" Closed Back
Single, 4" Closed Back
Double, 4" Closed Back / 4" Closed Back
Double, 4" Closed Back / 9" Closed Back

NOTES: Storage Shelves for Presentation Carts are available in three preconfigured sizes and may be used on fixed or adjustable height models.

Specify Model.Paint SPECIFYING EXAMPLE: HMVPCSS-40.TI

HMVPCSS-40
HMVPCSS-404C
HMVPCSS-409C
HMVPCSS-4C
HMVPCSS-4C4C
HMVPCSS-4C9C

8
17
20
9
18
21

1.4
2.6
3.6
1.4
2.6
3.6

\$102
\$208
\$325
\$111
\$218
\$335

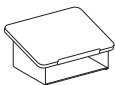

OPEN MARKET

Presentation Cart Desk Top Lectern, 2mm Edge

NOTES: Desk Top Lectern may be used on the Presentation Cart or is removable for use on table tops.

! \$15 list upcharge for L2 laminates.

! Desktop Lectern only available with 2mm edge.

Specify Model.LaminateTop.EdgeColor.Paint SPECIFYING EXAMPLE: HMVPC-DTLG.D.D.TI

HMVPC-DTLG

16

2.4

\$374





HOW TO SPECIFY

Select
Model Number

H M V M B - 3 6 7 2 W W

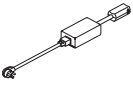

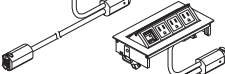
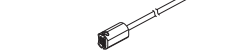
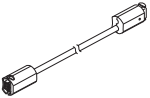
INTERLINK IQ ELECTRICAL

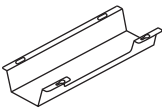
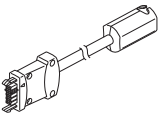
| | DESCRIPTION | MODEL | SHIP WEIGHT | CUBE | LIST PRICE |
|--|---|--|-------------|------------|-----------------------------|
|  | Power Base In-Feed • 12 amp circuit breaker is built in to the Power Base In-Feed. • Available in Black finish, no specification needed. | HQB | 2.0 | 0.2 | \$566 |
|  | Power Harness – 1' Power Hub, 3" Round Grommet Mount • Available in Black finish, no specification needed. | HQH1-3 | 2.0 | 0.2 | \$186 |
|  | Power Harness – 5' Power Hub, 3" Round Grommet Mount • Available in Black finish, no specification needed. | HQH5-3 | 2.0 | 0.2 | \$208 |
|  | Power Harness – 5' with 4" x 8" Pop-Up Port (3 Power, 1 Blank) • For use with tables G1 grommet. Specify paint. | HQH5-P-3P1B | 3.0 | 0.3 | \$408 |
|  | Power Jumper – 3' • Available in Black finish, no specification needed. | HQJ3 | 2.0 | 0.2 | \$117 |
|  | Ganging Hardware • Includes two ganging links and two screws. • No color designator when specifying. <i>Example: HMAGANG.</i> | HMAGANG | 1.0 | 0.1 | \$102 |
|  | Cable Management Troughs 17"W – Single 17"W – 10-Pack • Available in Graphite finish, no specification needed. NOTES: For additional information see page 208. | HCTROUGH17 HCTROUGH1710 | 2.7 14.0 | 0.5 0.5 | \$73 \$665 |
|  | IQ 1.0 Backward Compatible Jumper 36" • Available in Black finish, no specification needed. • Use when connecting Interlink IQ 1.0 power harness (rectangle end) to Interlink IQ 2.0 (oval end) power harness. ! If using Interlink IQ 2.0 in-feed with Interlink IQ 1.0 power harness please contact Customer Support. | HQB CJ36 | 2.0 | 0.2 | \$89 |

Specification guide for IQ Electrical on Motivate® tables

Determine table width, the type of power access being used (3" grommet or 4x8 pop-up) and the desired number per table (Columns 1, 2 or 3). The table will then identify the type and quantity of components needed per table along with the maximum table run. Note that this is in addition to the Power base in-feed which is needed for each run. For example, a 48"W table with two 3" power grommets per table will require (1) HQH5-3 harness and (1) HQH1-3 harness per table with a maximum run of four tables.

| Top Width | POWER ONE (1) PER TABLE 3" ROUND POWER GROMMET | | POWER TWO (2) PER TABLE 3" ROUND POWER GROMMETS | | POWER ONE (1) PER TABLE 4x8 POP-UP PORT | |
|------------------------|---|-------------------|--|--------------------|--|-------------------|
| | Quantity | Table Run Maximum | Quantity | Table Run Maximum | Quantity | Table Run Maximum |
| 36" | (1) HQH5-3 | 8 | N/A | N/A | (1) HQH5-P | 8 |
| 42" | (1) HQH5-3 | 8 | N/A | N/A | (1) HQH5-P | 8 |
| 48" | (1) HQH5-3 | 8 | (1) HQH5-3 (1) HQH1-3 | 4 Max Table Run | (1) HQH5-P | 8 |
| 54" | (1) HQH5-3 | 8 | (1) HQH5-3 (1) HQH1-3 | 4 Max Table Run | (1) HQH5-P | 8 |
| 60" | (1) HQH5-3 | 8 | (1) HQH5-3 (1) HQH1-3 | 4 Max Table Run | (1) HQH5-P | 8 |
| 66" | (1) HQH5-3 (1) HQJ3 | 4 | (1) HQH5-3 (1) HQH1-3 | 4 Max Table Run | (1) HQH5-P (1) HQJ3 | 4 |
| 72" | (1) HQH5-3 (1) HQJ3 | 4 | (1) HQH5-3 (1) HQH1-3 | 4 Max Table Run | (1) HQH5-P (1) HQJ3 | 4 |
| 84" | (1) HQH5-3 (1) HQJ3 | 4 | (2) HQH5-3 | 4 Max Table Run | (1) HQH5-P (1) HQJ3 | 4 |
| 96" | (1) HQH5-3 (1) HQJ3 | 4 | (2) HQH5-3 | 4 Max Table Run | (1) HQH5-P (1) HQJ3 | 4 |
| Half-Round (all sizes) | (1) HQH1-3 | 2 | N/A | N/A | (1) HQH5-P | 2 |
| Trapezoid (all sizes) | (1) HQH5-3 | 8 | N/A | N/A | (1) HQH5-P | 8 |

NOTES:

- Interlink IQ Electrical is a pluggable, single circuit electrical system.
- All electrical models include wire management clips and hardware.
- Interlink IQ Electrical is non-sequential/non-directional.

- Interlink IQ Electrical is UL Recognized as a Powered Table System and meets the requirements of UL 962 when paired with Motivate® or Huddle tables.

! 40' maximum run, or no more than 8 units, whichever comes first. Interlink IQ system will automatically shut off if maximum requirements are exceeded. Maximum run is based upon electrical harness width, not table width.

HOW TO SPECIFY

| | |
|---|--|
| Select Model Number HQH5 - P - 3 P1 B . | Select Paint Color FOG Fog SVR Silver BLK Black SVR |
|---|--|

4-TRAC HARDWIRE ELECTRICAL SYSTEM

4-Trac Electrical System

The 4-Trac Electrical System is a UL-recognized Manufactured Wiring System that seamlessly passes power from one worksurface to another. This low-profile non-sequential electrical system allows tables to be “daisy-chained” together in any desired order and allows users to reconfigure quickly due to simple connectable/disconnectable links.

- Meets requirements of UL 183 and National Electric Code Article 604
- 4-Wires, 2-circuits, 20 Amps each (Circuit 1 and Circuit 2 only)
- 13 Duplex Receptacles per circuit, 26, 15 Amp Duplex receptacle per power in-feed
- Electrical system attaches directly to underside of worksurface with included brackets
- Up to twelve tables can be linked together

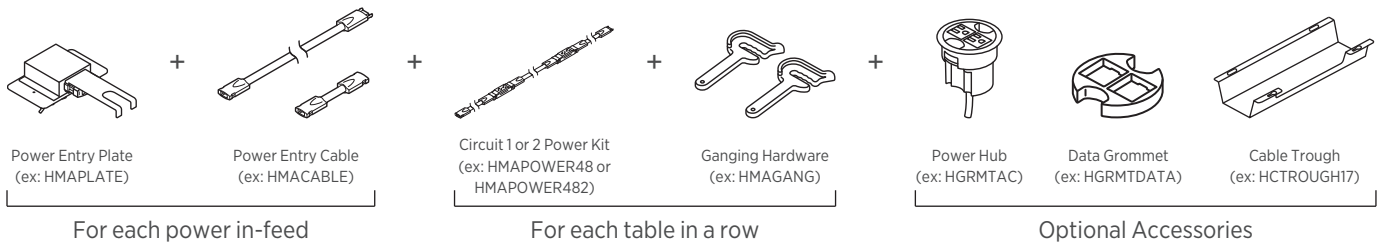



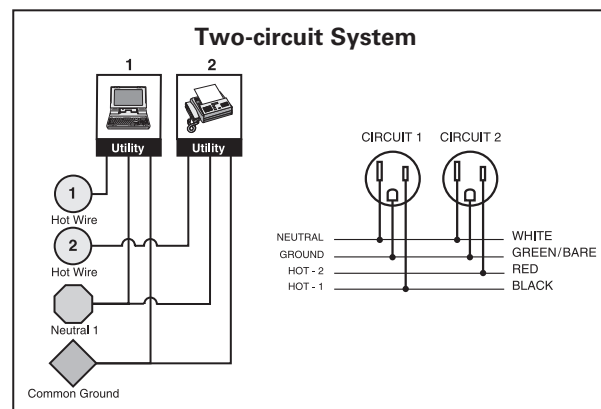
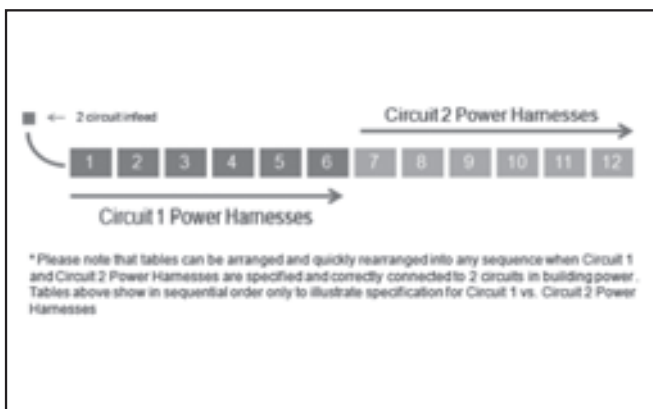

Steps for Electrical Specifications:

- Determine how many rows of tables are needed and order the following:
 - One HMAPLATE per row (or power in-feed)
 - One HMACABLE per row (or power in-feed)
- Order one power harness per table in each row
 - For 1-6 tables in a row (see illustration 1)
 - Order Circuit 1 Power Harnesses (ex. If powering six 24x60 tables order six sets of HMAPOWER60)
 - For 7-12 tables in a row (see illustration 1)
 - Order Circuit 1 Power Harness for first six tables and Circuit 2 Power Harness for remaining tables (ex. If powering eight 24x60 tables, order six sets of HMAPOWER60 and two sets of HMAPOWER602)
- Order one set of ganging hardware per table (ex. HMAGANG)
- Determine which accessories are needed:
 - Power Hub model HGRMTAC — to access power at worksurface.
 - Data Grommet model HGRMTDATA — to access data at worksurface.
 - Wire Management strips model HBTMS — for vertical and horizontal wire management.

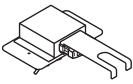
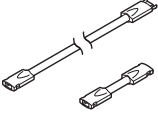

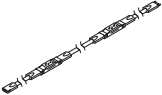
4-TRAC HARDWIRE ELECTRICAL SYSTEM

| | DESCRIPTION | MODEL | SHIP WEIGHT | CUBE | LIST PRICE |
|---|---|--------------------|-------------|--------------|--------------|
|  | Power Entry Plate | HMAPLATE | 1.0 | 0.2 | \$102 |
|  | Power Entry Cable • 6' power entry cable with male/female adapter. • Connects table to power entry plate. | HMACABLE | 1.8 | 0.2 | \$159 |
|  | Power Jumper Cable To connect tables front to front | HMAJUMP | 0.5 | 0.3 | \$54 |
|  | Circuit 1 Power Kit for 36" W Table | HMAPOWER36 | 1.5 | 0.3 | \$289 |
| | Circuit 1 Power Kit for 42" W Table | HMAPOWER42 | 1.8 | 0.3 | \$292 |
| | Circuit 1 Power Kit for 48" W Table | HMAPOWER48 | 1.8 | 0.3 | \$294 |
| | Circuit 1 Power Kit for 54" W Table | HMAPOWER54 | 2.0 | 0.3 | \$299 |
| | Circuit 1 Power Kit for 60" W Table | HMAPOWER60 | 2.0 | 0.3 | \$302 |
| | Circuit 1 Power Kit for 66" W Table | HMAPOWER66 | 2.2 | 0.3 | \$306 |
| | Circuit 1 Power Kit for 72" W Table | HMAPOWER72 | 2.2 | 0.3 | \$309 |
| | Circuit 1 Power Kit for 84" W Table | HMAPOWER84 | 2.4 | 0.3 | \$320 |
| | Circuit 1 Power Kit for 96" W Table | HMAPOWER96 | 2.6 | 0.3 | \$331 |
| | Circuit 2 Power Kit for 36" W Table | HMAPOWER362 | 1.5 | 0.3 | \$289 |
| | Circuit 2 Power Kit for 42" W Table | HMAPOWER422 | 1.8 | 0.3 | \$292 |
| | Circuit 2 Power Kit for 48" W Table | HMAPOWER482 | 1.8 | 0.3 | \$294 |
| | Circuit 2 Power Kit for 54" W Table | HMAPOWER542 | 2.0 | 0.3 | \$299 |
| | Circuit 2 Power Kit for 60" W Table | HMAPOWER602 | 2.0 | 0.3 | \$302 |
| Circuit 2 Power Kit for 66" W Table | HMAPOWER662 | 2.2 | 0.3 | \$306 | |
| Circuit 2 Power Kit for 72" W Table | HMAPOWER722 | 2.2 | 0.3 | \$309 | |
| Circuit 2 Power Kit for 84" W Table | HMAPOWER842 | 2.4 | 0.3 | \$320 | |
| Circuit 2 Power Kit for 96" W Table | HMAPOWER962 | 2.6 | 0.3 | \$331 | |
|  | Electrical Connectors 4-Way Splitter  Available in Black (P) only. SPECIFYING EXAMPLE: HMASPLIT.P | HMASPLIT | 0.9 | 0.1 | \$55 |

NOTES:

- Each power kit includes two duplex receptacles and attaches to the underside of the worksurface with included brackets.
- Power Kits are compatible with various base types including nesting bases.

HOW TO SPECIFY

Select
Model Number

H M A P L A T E

OPTIONAL ELECTRICAL ACCESSORIES

GSA SIN 33721 EXCEPT AS NOTED



Icon Legend on page 17

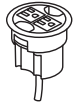

SIN 33721T

DESCRIPTION

Power Hub, 3" Grommet Mount, 6' Cord

- Fits in 3" round grommet holes.
- Field installed with Plug-and-play ease.
- Two grounded AC power outlets.
- Includes 6' cord with three-prong plug.
- Available in Black only. *Specify X when ordering. Example: HGRMTAC.X.*

NOTES: For additional information see page 204.

MODEL

HGRMTAC

SHIP WEIGHT

1.3

CUBE

0.2

LIST PRICE

\$126

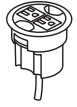

SIN 33721T

3" Round Power Grommet - 2 Outlets, 10' Cord

- Includes 10' cord with three-prong plug.
- Fits in 3" round grommet holes.
- Two grounded AC power outlets.
- Field installed with Plug-and-play ease.

NOTES: Power Modules will also work with standing-height applications for 10500 Series™ and Voi® desks.

- ! Available in black finish only, no specification needed.

HGRMTAC2

1.5

0.2

\$159



Data Grommet

Blank grommet kit that includes adapters for a variety of manufacturers jacks and couplers.

- Fits in existing 3" round grommet housing.
- Available in Black only. *Specify P when ordering. Example: HGRMTDATA.P.*

NOTES: For additional information see page 204.

HGRMTDATA

0.2

0.2

\$23

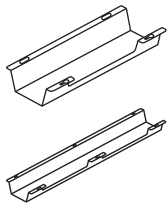

Cable Management Troughs

- 17"W - Single
- 17"W - 10-Pack
- 36"W - Single
- 36"W - 10-Pack

- Cable management troughs ship flat packed.
- The troughs attach to underneath the worksurface with screws.
- Cutouts in trough allow access to power without the need to detach from surface. 17"W = 1 cutout; 36"W = 2 cutouts.
- Color: Graphite.

NOTES: For additional information see page 208.

HCTROUGH17

2.7

0.5

\$73

HCTROUGH1710

14.0

0.5

\$665

HCTROUGH36

4.9

0.9

\$122

HCTROUGH3610

30.0

0.9

\$1121

HOW TO SPECIFY

Select Model Number

H T P W R G R O M 1



Preside® tables and bench shown
with Flock® guest seating.

PRESIDE®

Whether you're craving social interaction or breaking away for some "me time", Preside tables support the work activities you need to get it done. Versatile enough for touchdown spaces, meeting rooms, and even cafés, Preside offers everything from a contemporary light-scale vibe to a more classic aesthetic. Add in optional power for a dynamic table collection that lets you work your way.



FEATURES

- Preside offers a complete line of conference accessories, including presentation cabinets, hospitality and more.
- Optional flip-top and pop-up ports provide options today and for future data and power needs.
- Scratch-, spill- and stain-resistant laminate will look great for years to come.
- Add a splash of color to Preside using Colorwav™ paints to brighten any space.
- Enhanced aesthetics with power management options to keep the workspace tidy and looking its best.

PRESIDE® ORDERING INFORMATION

LAMINATE GROUP A

L1 LAMINATES CODES

- Woodgrain**
- ◆ Bourbon Cherry H
 - ◆ Cognac COGN
 - ◆ Florence Walnut LFW1
 - ◆ Harvest C
 - ◆ Kingswood Walnut LK11
 - ◆ Mahogany N
 - ◆ Mocha MOCH
 - ◆ Natural Maple D
 - ◆ Pinnacle PINC
 - ◆ Shaker Cherry F
 - ◆ Sterling Ash LSA1

- Solid**
- ◆ Black P
 - ◆ Charcoal S
 - ◆ Designer White LDW1
 - ◆ Loft LOFT

- Patterned**
- ◆ Handspun Chestnut LAHC
 - ◆ Handspun Dove LAHD
 - ◆ Handspun Pearl LAHP
 - ◆ Handspun Slate LAHS
 - ◆ Sheer Mesh * A5
 - ◆ Silver Mesh B9
 - ◆ Steel Mesh * A9
 - ◆ Canyon Zephyr * K9
 - ◆ Desert Zephyr * K8
 - ◆ Gray G2
 - ◆ Grey Tigris * L6
 - ◆ White G1
 - ◆ Whitestone * K4

L2 LAMINATES CODES

- Woodgrain**
- ◆ Lowell Ash LLA1
 - ◆ Natural Recon LNRI
 - ◆ Phantom Ecreu LPE1
 - ◆ Portico Teak LPT1
 - ◆ Skyline Walnut LSW1

LAMINATE GROUP B

L1 LAMINATES CODES

- Woodgrain**
- ◆ Bourbon Cherry H
 - ◆ Cognac COGN
 - ◆ Florence Walnut LFW1
 - ◆ Harvest C
 - ◆ Kingswood Walnut LK11
 - ◆ Mahogany N
 - ◆ Mocha MOCH
 - ◆ Natural Maple D
 - ◆ Pinnacle PINC
 - ◆ Shaker Cherry F
 - ◆ Sterling Ash LSA1

- Solid**
- ◆ Black P
 - ◆ Charcoal S
 - ◆ Designer White LDW1
 - ◆ Loft LOFT

L2 LAMINATES CODES

- Woodgrain**
- ◆ Lowell Ash LLA1
 - ◆ Natural Recon LNRI
 - ◆ Phantom Ecreu LPE1
 - ◆ Portico Teak LPT1
 - ◆ Skyline Walnut LSW1

LAMINATE GROUP C

L1 LAMINATES CODES

- Woodgrain**
- ◆ Bourbon Cherry H
 - ◆ Cognac COGN
 - ◆ Florence Walnut LFW1
 - ◆ Harvest C
 - ◆ Kingswood Walnut LK11
 - ◆ Mahogany N
 - ◆ Mocha MOCH
 - ◆ Natural Maple D
 - ◆ Pinnacle PINC
 - ◆ Shaker Cherry F
 - ◆ Sterling Ash LSA1

- Solid**
- ◆ Black P
 - ◆ Charcoal S
 - ◆ Designer White LDW1
 - ◆ Loft LOFT
 - ◆ Platinum LEPI

L2 LAMINATES CODES

- Woodgrain**
- ◆ Lowell Ash LLA1
 - ◆ Natural Recon LNRI
 - ◆ Phantom Ecreu LPE1
 - ◆ Portico Teak LPT1
 - ◆ Skyline Walnut LSW1

LAMINATE GROUP D

L1 LAMINATES CODES

- Woodgrain**
- ◆ Mahogany N

PAINT GROUP A

P1 CODES

- ◆ Black P
- ◆ Brownstone P7D
- ◆ Charcoal S
- ◆ Designer White PJW
- ◆ Fossil P28
- ◆ Greige T5
- ◆ Loft LOFT
- ◆ Muslin T3
- ◆ Titanium P8T

P2 CODES

- ◆ Champagne Metallic T4
- ◆ Platinum Metallic T1
- ◆ Silver PR6
- ◆ Solar Black P8X

P3 CODES

- ◆ Atom P8S
- ◆ Bullseye PJF
- ◆ Ember P8P
- ◆ Ion P8N
- ◆ Iris P8J
- ◆ Krypton P8F
- ◆ Regatta P8M

HON BRANDED FABRICS

GRADE 1

- Apex
- Attire
- Centurion
- Compass
- Contourett
- Dapper
- Ensemble
- Hamilton
- Inertia
- Optic
- Pebble

GRADE 2

- Appoint Seating
- Blume
- Clyde
- Dotty
- Rush
- Spin
- Whisper Vinyl

GRADE 3

- In Season
- Silvertex™ Vinyl

NOTES: Fabrics on Preside® bench cushion are upholstered in the railroad direction.

◆◆◆ For lead time information see page 17.
* De-emphasized

PRESIDE® SPECIFYING INFORMATION

| EDGE BAND OPTIONS | CODES | 2mm (G) | Knife (J) | T-Mold (E) | Traditional (T) |
|-------------------|-------|------------|--------------|---------------|--------------------|
| Bourbon Cherry | H | • | • | | |
| Cognac | COGN | • | • | • | |
| Florence Walnut | FW | • | • | • | |
| Harvest | C | • | • | | |
| Kingswood Walnut | KI | • | • | • | |
| Mahogany | N | • | • | • | • |
| Mocha | MOCH | • | • | • | |
| Natural Maple | D | • | • | | |
| Shaker Cherry | F | • | • | | |
| Sterling Ash | SA | • | • | • | |
| Black | P | • | • | • | |
| Brownstone | EY | • | • | • | |
| Charcoal | S | • | • | • | |
| Designer WHIT | DW | • | • | • | |
| Fossil | EH | • | • | • | |
| Greige | R | • | • | • | |
| Loft | LOFT | • | • | • | |
| Muslin | T | • | • | • | |
| Pinnacle | PINC | • | • | • | |
| Platinum | K | • | • | | |
| Lowell Ash | DL | • | • | | |
| Natural Recon | NR | • | • | | |
| Phantom Ecu | PE | • | • | | |
| Portico Teak | DP | • | • | | |
| Skyline Walnut | SW | • | • | | |

Recommended Edgeband Color Selection:

| Laminate | Edge |
|-----------------------|---------------------|
| Bourbon Cherry H | Bourbon Cherry H |
| Cognac COGN | Cognac COGN |
| Florence Walnut LFW1 | Florence Walnut FW |
| Harvest C | Harvest C |
| Kingswood Walnut LK11 | Kingswood Walnut KI |
| Mahogany N | Mahogany N |
| Mocha MOCH | Mocha MOCH |
| Natural Maple D | Natural Maple D |
| Pinnacle PINC | Pinnacle PINC |
| Shaker Cherry F | Shaker Cherry F |
| Sterling Ash LSA1 | Sterling Ash SA |
| Black P | Black P |
| Charcoal S | Charcoal S |
| Designer White LDW1 | Designer White DW |
| Loft LOFT | Loft LOFT |
| Whitestone K4 | Muslin T |
| Sheer Mesh A5 | Muslin T |
| Silver Mesh B9 | Loft LOFT |
| Steel Mesh A9 | Charcoal S |
| Canyon Zephyr K9 | Greige R |
| Desert Zephyr K8 | Greige R |
| Shadow Zephyr K1 | Loft LOFT |
| Gray G2 | Charcoal S |
| Grey Tigris L6 | Greige R |
| White G1 | Charcoal S |
| Lowell Ash LLA1 | Lowell Ash DL |
| Natural Recon LNR1 | Natural Recon NR |
| Phantom Ecu LPE1 | Phantom Ecu PE |
| Portico Teak LPT1 | Portico Teak DP |
| Skyline Walnut LSW1 | Skyline Walnut SW |

PRESIDE® SPECIFYING INFORMATION

Statement of Line

TOP SHAPES



Square



Round



Soft Square



Rectangle

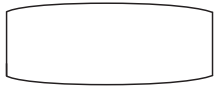

Boat



Racetrack



Arc End

TOP EDGE PROFILES

For Laminate Tops

Square/2mm Edgeband (1/8")



Knife Edge (1/8")



Traditional Edge (1/8")



T-Mold Edge (1/8")



BASES

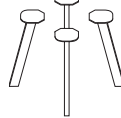
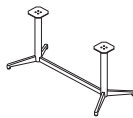
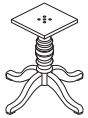
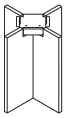
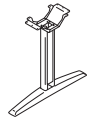
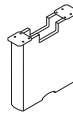
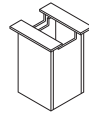
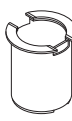
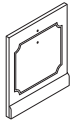
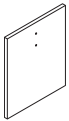

ANCILLARY COMPONENTS

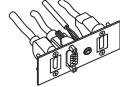
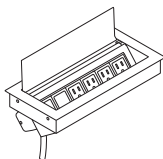
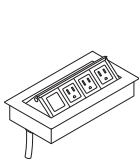
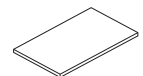
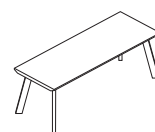
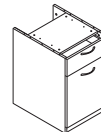
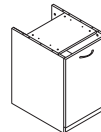
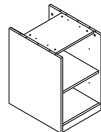
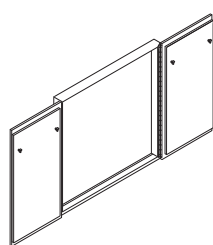
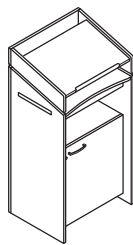
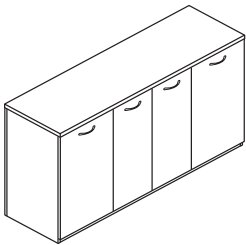







PRESIDE® SPECIFYING INFORMATION

Preside conference tops come in single piece or multi-piece sections depending on specified size. See below for top sizes, sections, and suggested seating capacity.





Product Reference: Sizes, Sections, Seating Capacity

Multi-piece tops: Rectangle, Racetrack, Boat, and Arc End Tops.



















Notes: Single- and two-piece tops ship in one carton, three-piece tops ship in two cartons.
Three-piece tops and larger will not contain grain match for all pieces.

| | Feet | Inches | 42"D | 48"D | 54"D | Suggested Capacity |
|---|------|--------|-----------|-----------|-----------|--------------------|
|  | 30 | 360" | 6 6 6 6 6 | 6 6 6 6 6 | 6 6 6 6 6 | 28-30 |
|  | 28 | 336" | 5 6 6 6 5 | 5 6 6 6 5 | 5 6 6 6 5 | 26-28 |
|  | 26 | 312" | 7 6 6 7 | 7 6 6 7 | 7 6 6 7 | 24-26 |
|  | 24 | 288" | 6 6 6 6 | 6 6 6 6 | 6 6 6 6 | 22-24 |
|  | 22 | 264" | 5 6 6 5 | 5 6 6 5 | 5 6 6 5 | 20-22 |
|  | 20 | 240" | 7 6 7 | 7 6 7 | 7 6 7 | 18-20 |
| | 18 | 216" | 6 6 6 | 6 6 6 | 6 6 6 | 16-18 |
| | 16 | 192" | 5 6 5 | 5 6 5 | 5 6 5 | 14-16 |
| | 15 | 180" | 4½ 6 4½ | 4½ 6 4½ | 4½ 6 4½ | 14-16 |
| | 14 | 168" | 7 7 | 7 7 | 7 7 | 12-14 |
| | 12 | 144" | 6 6 | 6 6 | 6 6 | 10-12 |
| | 10 | 120" | 5 5 | 5 5 | 5 5 | 8-10 |
| | 9 | 108" | 4½ 4½ | 4½ 4½ | 4½ 4½ | 8-10 |

Single-piece tops: Rectangle, Racetrack, Boat, and Arc End Tops

| | Feet | Inches | 30"D | 36"D | 42"D | 48"D | Suggested Capacity |
|---|------|--------|------|------|------|------|--------------------|
|  | 8 | 96" | | | 8 | 8 | 6-8 |
|  | 7 | 84" | | | 7 | | 4-6 |
|  | 6 | 72" | | 6 | | | 4-6 |
|  | 5 | 60" | 5 | | | | 4-6 |

Single-piece tops: Round, Square, and Soft Square

| | | 24" | 30" | 36" | 42" | 48" | 60"* | Suggested Capacity |
|---|-------------|---|---|---|---|---|---|--------------------|
|  | Round |  |  |  |  |  |  | 2-4 (*2-5) |
|  | Square |  |  |  |  |  | | 2-4 |
|  | Soft Square |  |  |  |  |  | | 2-4 |

PRESIDE[®] SPECIFYING INFORMATION

| Material | Type | Shape | Size | | | | | |
|----------|--------------------|-------------|------|-----|------------------------|------------------------|------------------------|------------------------|
| | | | 24" | 30" | 36" | 42" | 48" | 60" |
| Laminate | Cylinder | Round | N/A | N/A | ● ○ ○ ○ ○ ● ○ ○ ○ ○ | ○ ○ ○ ○ ○ ● ○ ○ ○ ○ | ○ ○ ○ ○ ○ ● ○ ○ ○ ○ | N/A |
| | | Square | N/A | N/A | ○ ○ ○ ○ ○ ● ○ ○ ○ ○ | ○ ○ ○ ○ ○ ● ○ ○ ○ ○ | ○ ○ ○ ○ ○ ● ○ ○ ○ ○ | |
| | | Soft Square | N/A | N/A | ○ ○ ○ ○ ○ ● ○ ○ ○ ○ | ○ ○ ○ ○ ○ ● ○ ○ ○ ○ | ○ ○ ○ ○ ○ ● ○ ○ ○ ○ | |
| | Cube | Round | N/A | N/A | N/A | N/A | ○ ○ ○ ○ ○ ● ○ ○ ○ ○ | ○ ○ ○ ○ ○ ● ○ ○ ○ ○ |
| | | Square | N/A | N/A | N/A | N/A | ○ ○ ○ ○ ○ ● ○ ○ ○ ○ | |
| | | Soft Square | N/A | N/A | N/A | N/A | ○ ○ ○ ○ ○ ● ○ ○ ○ ○ | |
| | X-Base | Round | N/A | N/A | ○ ○ ○ ○ ○ ● ○ ○ ○ ○ | ○ ○ ○ ○ ○ ● ○ ○ ○ ○ | ○ ○ ○ ○ ○ ● ○ ○ ○ ○ | N/A |
| | | Square | N/A | N/A | ○ ○ ○ ○ ○ ● ○ ○ ○ ○ | ○ ○ ○ ○ ○ ● ○ ○ ○ ○ | ○ ○ ○ ○ ○ ● ○ ○ ○ ○ | |
| | | Soft Square | N/A | N/A | ○ ○ ○ ○ ○ ● ○ ○ ○ ○ | ○ ○ ○ ○ ○ ● ○ ○ ○ ○ | ○ ○ ○ ○ ○ ● ○ ○ ○ ○ | |
| | Traditional X-Base | Round | N/A | N/A | ○ ○ ○ ○ ○ ● ○ ○ ○ ○ | ○ ○ ○ ○ ○ ● ○ ○ ○ ○ | ○ ○ ○ ○ ○ ● ○ ○ ○ ○ | N/A |
| | | Square | N/A | N/A | ○ ○ ○ ○ ○ ● ○ ○ ○ ○ | ○ ○ ○ ○ ○ ● ○ ○ ○ ○ | N/A | |
| | | Soft Square | N/A | N/A | ○ ○ ○ ○ ○ ● ○ ○ ○ ○ | ○ ○ ○ ○ ○ ● ○ ○ ○ ○ | N/A | |

| | | | |
|---------------------------------|--------|---------|----------|
| ● | ● | ● | ● |
| ○ | ○ | ○ | ○ |
| Working Lounge | Seated | Counter | Standing |
| 27H | 29H | 36H | 42H |
| ● Available | | | |
| ○ Unavailable or Not Compatible | | | |

PRESIDE® SPECIFYING INFORMATION

| | | Rectangle - Boat - Racetrack - Arc End | | | | | | | | | | | | | | |
|----------|---------------|--|-------|-------|-------|-------|-------|-------|-------|-------|-------|-------|-------|-------|-----------|-------|
| Material | Type | Width | 60" | 72" | 84" | 96" | 108" | 120" | 144" | 168" | 180" | 192" | 216" | 240" | 72" Adder | |
| | | Depth | | | | | | | | | | | | | | |
| Painted | Footed Y-Base | 30" | ●●●●● | | | | | | | | | | | | | |
| | | 36" | | ●●●●● | | | | | | | | | | | | |
| | | 42" | | | ●●●●● | ●●●●● | ●●●●● | ●●●●● | ●●●●● | ●●●●● | ●●●●● | ●●●●● | ●●●●● | ●●●●● | ●●●●● | ●●●●● |
| | | 48" | | | | ●●●●● | ●●●●● | ●●●●● | ●●●●● | ●●●●● | ●●●●● | ●●●●● | ●●●●● | ●●●●● | ●●●●● | ●●●●● |
| | | 54" | | | | | N/A | N/A | N/A | N/A | N/A | N/A | N/A | N/A | N/A | N/A |
| | Angled Leg | 30" | ○●●●● | | | | | | | | | | | | | |
| | | 36" | | ○●●●● | | | | | | | | | | | | |
| | | 42" | | | ○●●●● | ○●●●● | ○●●●● | ○●●●● | ○●●●● | ○●●●● | ○●●●● | ○●●●● | ○●●●● | ○●●●● | ○●●●● | ○●●●● |
| | | 48" | | | | ○●●●● | ○●●●● | ○●●●● | ○●●●● | ○●●●● | ○●●●● | ○●●●● | ○●●●● | ○●●●● | ○●●●● | ○●●●● |
| | | 54" | | | | | ○●●●● | ○●●●● | ○●●●● | ○●●●● | ○●●●● | ○●●●● | ○●●●● | ○●●●● | ○●●●● | ○●●●● |
| | T-Leg | 30" | ○●●●● | | | | | | | | | | | | | |
| | | 36" | | ○●●●● | | | | | | | | | | | | |
| | | 42" | | | ○●●●● | ○●●●● | ○●●●● | ○●●●● | ○●●●● | ○●●●● | ○●●●● | ○●●●● | ○●●●● | ○●●●● | ○●●●● | ○●●●● |
| | | 48" | | | | ○●●●● | ○●●●● | ○●●●● | ○●●●● | ○●●●● | ○●●●● | ○●●●● | ○●●●● | ○●●●● | ○●●●● | ○●●●● |
| | | 54" | | | | | ○●●●● | ○●●●● | ○●●●● | ○●●●● | ○●●●● | ○●●●● | ○●●●● | ○●●●● | ○●●●● | ○●●●● |

| | |
|--|---|
| | <p>● Available</p> <p>○ Unavailable or Not Compatible</p> |
|--|---|

PRESIDE[®]

SPECIFYING INFORMATION

| Material | Type | Rectangle - Boat - Racetrack - Arc End | | | | | | | | | | | | | |
|----------|-------------------|--|-----|-----|-----|-----|------|------|------|------|------|------|------|------|-----------|
| | | Width Depth | 60" | 72" | 84" | 96" | 108" | 120" | 144" | 168" | 180" | 192" | 216" | 240" | 72" Adder |
| Laminate | Panel | 30" | | | | | | | | | | | | | |
| | | 36" | | | | | | | | | | | | | |
| | | 42" | | | | | | | | | | | | | |
| | | 48" | | | | | | | | | | | | | |
| | | 54" | | | | | | | | | | | | | |
| | Traditional Panel | 30" | N/A | | | | | | | | | | | | |
| | | 36" | | | | | | | | | | | | | |
| | | 42" | | | | | | | | N/A | N/A | N/A | N/A | N/A | N/A |
| | | 48" | | | | | | | | N/A | N/A | N/A | N/A | N/A | N/A |
| | | 54" | | | | | | | | N/A | N/A | N/A | N/A | N/A | N/A |
| | Hollow Panel | 30" | N/A | | | | | | | | | | | | |
| | | 36" | | N/A | | | | | | | | | | | |
| | | 42" | | | N/A | N/A | N/A | N/A | N/A | N/A | N/A | N/A | N/A | N/A | N/A |
| | | 48" | | | | | | | | | | | | | |
| | | 54" | | | | | | | | | | | | | |

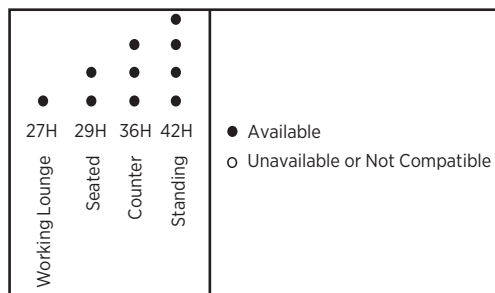

PRESIDE® SPECIFYING INFORMATION

| | | Rectangle - Boat - Racetrack - Arc End | | | | | | | | | | | | | |
|----------|-----------------------------|--|-----|-----|--------------------|--------------------|--------------------|--------------------|--------------------|--------------------|--------------------|--------------------|--------------------|--------------------|--------------------|
| Material | Type | Width | 60" | 72" | 84" | 96" | 108" | 120" | 144" | 168" | 180" | 192" | 216" | 240" | 72" Adder |
| | | Depth | | | | | | | | | | | | | |
| Laminate | Cube | 30" | N/A | | | | | | | | | | | | |
| | | 36" | | N/A | | | | | | | | | | | |
| | | 42" | | | ○ ○ ○ ○ ● ○ ○ ○ | ○ ○ ○ ○ ● ○ ○ ○ | ○ ○ ○ ○ ● ○ ○ ○ | ○ ○ ○ ○ ● ○ ○ ○ | ○ ○ ○ ○ ● ○ ○ ○ | ○ ○ ○ ○ ● ○ ○ ○ | ○ ○ ○ ○ ● ○ ○ ○ | ○ ○ ○ ○ ● ○ ○ ○ | ○ ○ ○ ○ ● ○ ○ ○ | ○ ○ ○ ○ ● ○ ○ ○ | ○ ○ ○ ○ ● ○ ○ ○ |
| | | 48" | | | ○ ○ ○ ○ ● ○ ○ ○ | ○ ○ ○ ○ ● ○ ○ ○ | ○ ○ ○ ○ ● ○ ○ ○ | ○ ○ ○ ○ ● ○ ○ ○ | ○ ○ ○ ○ ● ○ ○ ○ | ○ ○ ○ ○ ● ○ ○ ○ | ○ ○ ○ ○ ● ○ ○ ○ | ○ ○ ○ ○ ● ○ ○ ○ | ○ ○ ○ ○ ● ○ ○ ○ | ○ ○ ○ ○ ● ○ ○ ○ | ○ ○ ○ ○ ● ○ ○ ○ |
| | | 54" | | | ○ ○ ○ ○ ● ○ ○ ○ | ○ ○ ○ ○ ● ○ ○ ○ | ○ ○ ○ ○ ● ○ ○ ○ | ○ ○ ○ ○ ● ○ ○ ○ | ○ ○ ○ ○ ● ○ ○ ○ | ○ ○ ○ ○ ● ○ ○ ○ | ○ ○ ○ ○ ● ○ ○ ○ | ○ ○ ○ ○ ● ○ ○ ○ | ○ ○ ○ ○ ● ○ ○ ○ | ○ ○ ○ ○ ● ○ ○ ○ | ○ ○ ○ ○ ● ○ ○ ○ |
| | Cylinder | 30" | N/A | | | | | | | | | | | | |
| | | 36" | | N/A | | | | | | | | | | | |
| | | 42" | | | ○ ○ ○ ○ ● ○ ○ ○ | ○ ○ ○ ○ ● ○ ○ ○ | ○ ○ ○ ○ ● ○ ○ ○ | ○ ○ ○ ○ ● ○ ○ ○ | ○ ○ ○ ○ ● ○ ○ ○ | ○ ○ ○ ○ ● ○ ○ ○ | ○ ○ ○ ○ ● ○ ○ ○ | ○ ○ ○ ○ ● ○ ○ ○ | ○ ○ ○ ○ ● ○ ○ ○ | ○ ○ ○ ○ ● ○ ○ ○ | ○ ○ ○ ○ ● ○ ○ ○ |
| | | 48" | | | ○ ○ ○ ○ ● ○ ○ ○ | ○ ○ ○ ○ ● ○ ○ ○ | ○ ○ ○ ○ ● ○ ○ ○ | ○ ○ ○ ○ ● ○ ○ ○ | ○ ○ ○ ○ ● ○ ○ ○ | ○ ○ ○ ○ ● ○ ○ ○ | ○ ○ ○ ○ ● ○ ○ ○ | ○ ○ ○ ○ ● ○ ○ ○ | ○ ○ ○ ○ ● ○ ○ ○ | ○ ○ ○ ○ ● ○ ○ ○ | ○ ○ ○ ○ ● ○ ○ ○ |
| | | 54" | | | ○ ○ ○ ○ ● ○ ○ ○ | ○ ○ ○ ○ ● ○ ○ ○ | ○ ○ ○ ○ ● ○ ○ ○ | ○ ○ ○ ○ ● ○ ○ ○ | ○ ○ ○ ○ ● ○ ○ ○ | ○ ○ ○ ○ ● ○ ○ ○ | ○ ○ ○ ○ ● ○ ○ ○ | ○ ○ ○ ○ ● ○ ○ ○ | ○ ○ ○ ○ ● ○ ○ ○ | ○ ○ ○ ○ ● ○ ○ ○ | ○ ○ ○ ○ ● ○ ○ ○ |
| | Cylinder w/ Wire Management | 30" | N/A | | | | | | | | | | | | |
| | | 36" | | N/A | | | | | | | | | | | |
| | | 42" | | | ○ ○ ○ ○ ● ○ ○ ○ | ○ ○ ○ ○ ● ○ ○ ○ | ○ ○ ○ ○ ● ○ ○ ○ | ○ ○ ○ ○ ● ○ ○ ○ | ○ ○ ○ ○ ● ○ ○ ○ | ○ ○ ○ ○ ● ○ ○ ○ | ○ ○ ○ ○ ● ○ ○ ○ | ○ ○ ○ ○ ● ○ ○ ○ | ○ ○ ○ ○ ● ○ ○ ○ | ○ ○ ○ ○ ● ○ ○ ○ | ○ ○ ○ ○ ● ○ ○ ○ |
| | | 48" | | | ○ ○ ○ ○ ● ○ ○ ○ | ○ ○ ○ ○ ● ○ ○ ○ | ○ ○ ○ ○ ● ○ ○ ○ | ○ ○ ○ ○ ● ○ ○ ○ | ○ ○ ○ ○ ● ○ ○ ○ | ○ ○ ○ ○ ● ○ ○ ○ | ○ ○ ○ ○ ● ○ ○ ○ | ○ ○ ○ ○ ● ○ ○ ○ | ○ ○ ○ ○ ● ○ ○ ○ | ○ ○ ○ ○ ● ○ ○ ○ | ○ ○ ○ ○ ● ○ ○ ○ |
| | | 54" | | | ○ ○ ○ ○ ● ○ ○ ○ | ○ ○ ○ ○ ● ○ ○ ○ | ○ ○ ○ ○ ● ○ ○ ○ | ○ ○ ○ ○ ● ○ ○ ○ | ○ ○ ○ ○ ● ○ ○ ○ | ○ ○ ○ ○ ● ○ ○ ○ | ○ ○ ○ ○ ● ○ ○ ○ | ○ ○ ○ ○ ● ○ ○ ○ | ○ ○ ○ ○ ● ○ ○ ○ | ○ ○ ○ ○ ● ○ ○ ○ | ○ ○ ○ ○ ● ○ ○ ○ |

| | |
|--|--|
| | <ul style="list-style-type: none"> ● Available ○ Unavailable or Not Compatible |
|--|--|

PRESIDE® SPECIFYING INFORMATION

Specify Preside tables with two steps—select a top and select a base.

1. Select desired top size, shape, and edge profile.

Multi-piece Tops:

Multi-piece tops are made of 108", 120", 144" and 168" two-piece "starter-sections" in rectangle, boat, arc end, or racetrack shapes in 42", 48", or 54" depths. For tables up to 20', models are preconfigured for you. If you need a table top longer than 20', add as many 72" adder sections as you need. The examples below illustrate preconfigured sizes as well as how starter section and adder section tops can be used to create tables in virtually any length. **Please note that 2-piece tops, in woodgrain colors, will not have exact grain alignment in the center where the two halves meet, a reasonable match can be expected. For tops utilizing an adder section, there will not be a grain match for those pieces.**

Preconfigured and Modular Size Examples

| | Feet | Inches | Ex. Top Starter Section | Quantity | Adder Section | Quantity | Total Number of Top Sections |
|---------------------|------|--------|-------------------------|----------|---------------|----------|------------------------------|
| Preconfigured Sizes | 9' | 108" | HTLC48108 | 1 | n/a | n/a | 2 |
| | 10' | 120" | HTLC48120 | 1 | n/a | n/a | 2 |
| | 12' | 144" | HTLC48144 | 1 | n/a | n/a | 2 |
| | 14' | 168" | HTLC48168 | 1 | n/a | n/a | 2 |
| | 15' | 180" | HTLC48180 | 1 | n/a | n/a | 3 |
| | 16' | 192" | HTLC48192 | 1 | n/a | n/a | 3 |
| | 18' | 216" | HTLC48216 | 1 | n/a | n/a | 3 |
| | 20' | 240" | HTLC48240 | 1 | n/a | n/a | 3 |
| Modular Sizes | 22' | 264" | HTLC48120 | 1 | HTLM4872 | 2 | 4 |
| | 24' | 288" | HTLC48144 | 1 | HTLM4872 | 2 | 4 |
| | 26' | 312" | HTLC48168 | 1 | HTLM4872 | 2 | 4 |
| | 28' | 336" | HTLC48120 | 1 | HTLM4872 | 3 | 5 |
| | 30' | 360" | HTLC48144 | 1 | HTLM4872 | 3 | 5 |

Note: Beyond 30', tables can be configured in 6' increments to any length.

Illustrations of Preconfigured Tops

48" x 108" Table Top (9')

| | |
|-----|-----|
| 54" | 54" |
|-----|-----|

Ex: HTLC48108

48" x 120" Table Top (10')

| | |
|-----|-----|
| 60" | 60" |
|-----|-----|

Ex: HTLC48120

48" x 144" Table Top (12')

| | |
|-----|-----|
| 72" | 72" |
|-----|-----|

Ex: HTLC48144

48" x 168" Table Top (14')

| | |
|-----|-----|
| 84" | 84" |
|-----|-----|

Ex: HTLC48168

48" x 180" Table Top (15')

| | | |
|-----|-----|-----|
| 54" | 72" | 54" |
|-----|-----|-----|

Ex: HTLC48180

48" x 192" Table Top (16')

| | | |
|-----|-----|-----|
| 60" | 72" | 60" |
|-----|-----|-----|

Ex: HTLC48192

48" x 216" Table Top (18')

| | | |
|-----|-----|-----|
| 72" | 72" | 72" |
|-----|-----|-----|

Ex: HTLC48216

48" x 240" Table Top (20')

| | | |
|-----|-----|-----|
| 84" | 72" | 84" |
|-----|-----|-----|

Ex: HTLC48240

Illustrations of User Configured Modular Tops

48" x 72" Adder Section

| |
|-----|
| 72" |
|-----|

Ex: HTLM4872

48"D x 360"W Table Top (30')

| | | | | |
|-----|-----|-----|-----|-----|
| 72" | 72" | 72" | 72" | 72" |
|-----|-----|-----|-----|-----|

Ex: HTLC48144 + HTLM4872 + HTLM4872 + HTLM4872

PRESIDE® SPECIFYING INFORMATION

2. Select desired base style and identify model that coincides with top length.

Bases for Tops in Preconfigured Sizes

Bases include the appropriate number of supports for tables up to 20'. Simply identify the length of the table top in inches and specify the base with the same length in the model number. The example below illustrates how to select a base for a preconfigured size top.

Examples of Base for Preconfigured Top Size

Example top: HTLC48240 Top Description: 240" Rectangle Top
 Example base: HTLHP240 Base Description: Hollow Panel Base for 240" Top

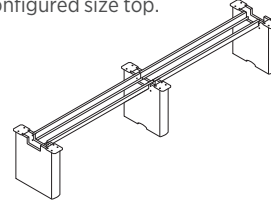

Example: HTLHP240

Bases for Tops in User Configured Modular Sizes

If you need a table top longer than 20', add as many 72" adder section bases as needed. The examples below illustrate preconfigured sizes as well as how starter section and adder section bases can be used to create tables in any desired length.

Examples of Tops and Bases for User Configured Modular Top

| | Feet | Inches | Ex. Top Starter Section | | Ex. Top Adder Section | | Ex. Base Starter Section | | Ex. Base Adder Section | | Total # of Top Sections |
|---------------------|------|--------|-------------------------|----------|-----------------------|----------|--------------------------|----------|------------------------|-----|-------------------------|
| | | | Quantity | Quantity | Quantity | Quantity | Quantity | Quantity | | | |
| Preconfigured Sizes | 9' | 108" | HTLC48108 | 1 | n/a | n/a | HTLHP108 | 1 | n/a | n/a | 2 |
| | 10' | 120" | HTLC48120 | 1 | n/a | n/a | HTLHP120 | 1 | n/a | n/a | 2 |
| | 12' | 144" | HTLC48144 | 1 | n/a | n/a | HTLHP144 | 1 | n/a | n/a | 2 |
| | 14' | 168" | HTLC48168 | 1 | n/a | n/a | HTLHP168 | 1 | n/a | n/a | 2 |
| | 15' | 180" | HTLC48180 | 1 | n/a | n/a | HTLHP180 | 1 | n/a | n/a | 3 |
| | 16' | 192" | HTLC48192 | 1 | n/a | n/a | HTLHP192 | 1 | n/a | n/a | 3 |
| | 18' | 216" | HTLC48216 | 1 | n/a | n/a | HTLHP216 | 1 | n/a | n/a | 3 |
| | 20' | 240" | HTLC48240 | 1 | n/a | n/a | HTLHP240 | 1 | n/a | n/a | 3 |
| Modular Sizes | 22' | 264" | HTLC48120 | 1 | HTLM4872 | 2 | HTLHP120 | 1 | HTLHPM | 2 | 4 |
| | 24' | 288" | HTLC48144 | 1 | HTLM4872 | 2 | HTLHP144 | 1 | HTLHPM | 2 | 4 |
| | 26' | 312" | HTLC48168 | 1 | HTLM4872 | 2 | HTLHP168 | 1 | HTLHPM | 2 | 4 |
| | 28' | 336" | HTLC48120 | 1 | HTLM4872 | 3 | HTLHP120 | 1 | HTLHPM | 3 | 5 |
| | 30' | 360" | HTLC48144 | 1 | HTLM4872 | 3 | HTLHP144 | 1 | HTLHPM | 3 | 5 |

Note: Tables can be configured to any desired length beyond 30' in 6' increments.

Note: Preconfigured bases include the appropriate number of supports for tables up to 20'. Depending on base type, number of required supports varies. For information regarding total number of supports please refer to chart below.

| Feet | Inches | HTLP | HTLT | HTTLEG | HTLHP | HTLCUBE/S | HTLR/C | HTYLEG | HTALEG |
|------|--------|------|------|--------|-------|-----------|--------|--------|--------|
| 9' | 108" | 2 | 2 | 2 | 2 | 2 | 2 | 3 | 6 |
| 10' | 120" | 2 | 2 | 2 | 2 | 2 | 2 | 3 | 6 |
| 12' | 144" | 2 | 2 | 2 | 2 | 2 | 2 | 3 | 6 |
| 14' | 168" | 3 | 3 | 3 | 3 | 2 | 2 | 3 | 6 |
| 15' | 180" | 3 | n/a | 3 | 3 | 3 | 3 | 4 | 8 |
| 16' | 192" | 3 | n/a | 3 | 3 | 3 | 3 | 4 | 8 |
| 18' | 216" | 3 | n/a | 3 | 3 | 3 | 3 | 4 | 8 |
| 20' | 240" | 4 | n/a | 4 | 3 | 3 | 3 | 4 | 8 |

Base Model Descriptions

- HTLP = Panel Base
- HTLT = Traditional Panel Base
- HTTLEG = Aluminum T-Leg
- HTLHP = Hollow Panel Base
- HTLCUBE = Cube Base
- HTLCUBES = Standing-Height Cube Base
- HTLR = Cylinder Base
- HTLRC = Wire Management Cylinder Base
- HTYLEG = Footed Y-Leg Base
- HTALEG = Angled Leg

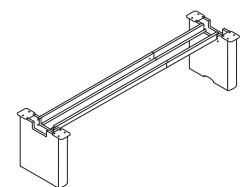

Example: HTHLP168

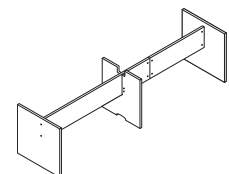

Example: HTLP168

PRESIDE® Grommet Cutout Placement

Tops specified with a grommet cutout get one cutout per section of top, centered in both directions. Cutouts do not include blank or powered inserts. Inserts must be specified separately.

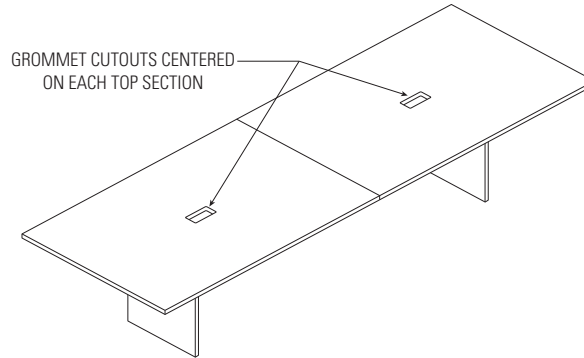

Upcharges for grommet cutouts (\$15 per G cutout, \$40 per G1 cutout, \$50 per G2 cutout)



| Top Width | # Cutouts | G | G1 | G2 |
|-----------|-----------|------|-------|-------|
| 24" | 1 | \$15 | N/A | N/A |
| 30" | 1 | \$15 | N/A | N/A |
| 36" | 1 | N/A | \$40 | \$50 |
| 42" | 1 | N/A | \$40 | \$50 |
| 48" | 1 | N/A | \$40 | \$50 |
| 60" | 1 | N/A | \$40 | \$50 |
| 72" | 1 | N/A | \$40 | \$50 |
| 84" | 1 | N/A | \$40 | \$50 |
| 96" | 1 | N/A | \$40 | \$50 |
| 108" | 2 | N/A | \$80 | \$100 |
| 120" | 2 | N/A | \$80 | \$100 |
| 144" | 2 | N/A | \$80 | \$100 |
| 168" | 2 | N/A | \$80 | \$100 |
| 180" | 3 | N/A | \$120 | \$150 |
| 192" | 3 | N/A | \$120 | \$150 |
| 216" | 3 | N/A | \$120 | \$150 |
| 240" | 3 | N/A | \$120 | \$150 |

PRESIDE® Laminate Table Tops

GSA SIN 33721

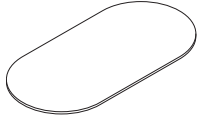
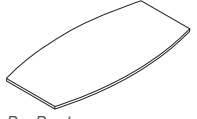
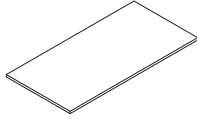
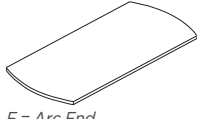

Icon Legend on page 17

| DESCRIPTION | MODEL | SHIP WEIGHT | CUBE | LIST PRICE BY EDGE TREATMENT | | | | L2 UPCHARGE | |
|---|--|-------------|------|------------------------------|--------|--------|--------|-------------|-------|
| | | | | "E" | "G" | "J" | "T" | | |
| Laminate Boat, Racetrack, Rectangle and Arc End Shaped Tops | | | | | | | | | |
|  A = Racetrack Not available in "T" edge option | 240"W x 54"D | HTL(?)54240 | 425 | 25.1 | N/A | \$2975 | \$4780 | N/A | \$125 |
| | 216"W x 54"D | HTL(?)54216 | 384 | 23.3 | N/A | \$2600 | \$4074 | N/A | \$105 |
| | 192"W x 54"D | HTL(?)54192 | 345 | 21.4 | N/A | \$2423 | \$3864 | N/A | \$100 |
| | 180"W x 54"D | HTL(?)54180 | 442 | 21.4 | N/A | \$2423 | \$3864 | N/A | \$100 |
| | 168"W x 54"D | HTL(?)54168 | 300 | 13.5 | \$1854 | \$2002 | \$3121 | N/A | \$85 |
| | 144"W x 54"D | HTL(?)54144 | 259 | 11.6 | \$1514 | \$1627 | \$2415 | N/A | \$65 |
| | 120"W x 54"D | HTL(?)54120 | 220 | 9.8 | \$1345 | \$1450 | \$2205 | N/A | \$60 |
| | 108"W x 54"D | HTL(?)54108 | 324 | 9.8 | \$1345 | \$1450 | \$2205 | N/A | \$60 |
|  B = Boat Not available in "T" edge option | 240"W x 48"D | HTL(?)48240 | 392 | 21.9 | N/A | \$2416 | \$3882 | N/A | \$105 |
| | 216"W x 48"D | HTL(?)48216 | 351 | 19.7 | N/A | \$2116 | \$3322 | N/A | \$90 |
| | 192"W x 48"D | HTL(?)48192 | 312 | 18.1 | N/A | \$1976 | \$3153 | N/A | \$85 |
| | 180"W x 48"D | HTL(?)48180 | 300 | 18.6 | N/A | \$1976 | \$3153 | N/A | \$85 |
| | 168"W x 48"D | HTL(?)48168 | 281 | 12.1 | \$1482 | \$1602 | \$2495 | \$4121 | \$70 |
| | 144"W x 48"D | HTL(?)48144 | 240 | 9.8 | \$1212 | \$1302 | \$1935 | \$3579 | \$55 |
| | 120"W x 48"D | HTL(?)48120 | 201 | 8.2 | \$1077 | \$1162 | \$1766 | \$2898 | \$50 |
| | 108"W x 48"D | HTL(?)48108 | 203 | 9.8 | \$1077 | \$1162 | \$1766 | N/A | \$50 |
| | 96"W x 48"D | HTL(?)4896 | 153 | 13.2 | \$914 | \$945 | \$1414 | \$2236 | \$50 |
|  C = Rectangle | 240"W x 42"D | HTL(?)42240 | 382 | 27.1 | \$2116 | \$2221 | \$3469 | N/A | \$99 |
| | 216"W x 42"D | HTL(?)42216 | 350 | 25.8 | \$1889 | \$1977 | \$3097 | N/A | \$88 |
| | 192"W x 42"D | HTL(?)42192 | 317 | 22.2 | \$1776 | \$1856 | \$2912 | N/A | \$83 |
| | 180"W x 42"D | HTL(?)42180 | 302 | 22.2 | \$1776 | \$1856 | \$2912 | N/A | \$83 |
| | 168"W x 42"D | HTL(?)42168 | 255 | 18.7 | \$1414 | \$1519 | \$2318 | N/A | \$66 |
| | 144"W x 42"D | HTL(?)42144 | 223 | 17.4 | \$1187 | \$1275 | \$1946 | N/A | \$55 |
| | 120"W x 42"D | HTL(?)42120 | 190 | 13.8 | \$1074 | \$1154 | \$1761 | N/A | \$50 |
| | 108"W x 42"D | HTL(?)42108 | 175 | 13.8 | \$1074 | \$1154 | \$1761 | N/A | \$50 |
| | 96"W x 42"D | HTL(?)4296 | 159 | 22.8 | N/A | \$954 | \$1423 | N/A | \$40 |
| | 84"W x 42"D | HTL(?)4284 | 157 | 12.1 | \$914 | \$945 | \$1414 | N/A | \$40 |
| | 72"W x 36"D | HTL(?)3672 | 90 | 7.9 | \$609 | \$663 | \$1070 | \$1167 | \$30 |
| | 60"W x 30"D | HTL(?)3060 | 63 | 5.6 | \$482 | \$525 | \$861 | N/A | \$20 |
|  E = Arc End Not available in "T" edge option | 240"W x 42"D | HTL(?)42240 | 382 | 27.1 | \$2116 | \$2221 | \$3469 | N/A | \$99 |
| | 216"W x 42"D | HTL(?)42216 | 350 | 25.8 | \$1889 | \$1977 | \$3097 | N/A | \$88 |
| | 192"W x 42"D | HTL(?)42192 | 317 | 22.2 | \$1776 | \$1856 | \$2912 | N/A | \$83 |
| | 180"W x 42"D | HTL(?)42180 | 302 | 22.2 | \$1776 | \$1856 | \$2912 | N/A | \$83 |
| | 168"W x 42"D | HTL(?)42168 | 255 | 18.7 | \$1414 | \$1519 | \$2318 | N/A | \$66 |
| | 144"W x 42"D | HTL(?)42144 | 223 | 17.4 | \$1187 | \$1275 | \$1946 | N/A | \$55 |
| | 120"W x 42"D | HTL(?)42120 | 190 | 13.8 | \$1074 | \$1154 | \$1761 | N/A | \$50 |
| | 108"W x 42"D | HTL(?)42108 | 175 | 13.8 | \$1074 | \$1154 | \$1761 | N/A | \$50 |
| | 96"W x 42"D | HTL(?)4296 | 159 | 22.8 | N/A | \$954 | \$1423 | N/A | \$40 |
| | 84"W x 42"D | HTL(?)4284 | 157 | 12.1 | \$914 | \$945 | \$1414 | N/A | \$40 |
| | 72"W x 36"D | HTL(?)3672 | 90 | 7.9 | \$609 | \$663 | \$1070 | \$1167 | \$30 |
| | 60"W x 30"D | HTL(?)3060 | 63 | 5.6 | \$482 | \$525 | \$861 | N/A | \$20 |
| Laminate Adder Section for Boat, Racetrack, Rectangle and Arc Shaped Tops | | | | | | | | | |
| | 72"W x 54"D | HTLM5472 | 125 | 11.6 | N/A | \$973 | \$1659 | N/A | \$40 |
| | 72"W x 48"D | HTLM4872 | 111 | 9.8 | N/A | \$814 | \$1387 | N/A | \$35 |
| | 72"W x 42"D | HTLM4272 | 127 | 8.4 | \$702 | \$754 | \$1151 | N/A | \$33 |
|  M = Mid-section Adder | ⚠ Adder section cannot be used as stand-alone table. Only long edges are finished. | | | | | | | | |

NOTES:

- Tops with E, G, and T edge details feature durable laminate tops over solid core high-performance particleboard. Tops with J edge feature an MDF core.
- Laminate tops with Traditional (T) edge feature high gloss laminate and wood edge to coordinate with 94000 Series Desks.
- Tops with E edge detail have 3" radius corners. All other edge details have 90 degree corners.
- See page 93 for number of cutouts for each table top size.

⚠ Tops with Traditional edge available in Mahogany only.

⚠ See pages 85-90 for top and base compatibility.

HOW TO SPECIFY

| | | | |
|---|--|--|---|
| <p>Select Model Number</p> <p>For laminate tops with Traditional (T) edge, place a "T" at the end of the base model.</p> <p>HTLC4296</p> <p>Traditional Edge</p> <p>HTLC4896T</p> | <p>Select Edge Detail and Edge Color</p> <p>See page 83</p> <p>For laminate tops with Traditional (T) edge, select edge color ONLY.</p> <p>J C</p> <p>N</p> | <p>Select Cutout Option</p> <p>N No Cutout</p> <p>G1 Cutout for Pop-up Port (\$40 upcharge per cutout)</p> <p>G2 Cutout for Flip-top Port (\$50 upcharge per cutout) Flip-top Port cannot be specified for Round or Square tops</p> <p>G 2</p> <p>G 2</p> | <p>Select Laminate</p> <p>See page 82, Laminate Group A</p> <p>D</p> <p>See page 82, Laminate Group D</p> <p>N</p> |
|---|--|--|---|



PRESIDE® Laminate Table Tops



D = Round

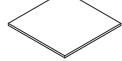

S = Square



SFT = Soft Square

| DESCRIPTION | MODEL | SHIP WEIGHT | | | LIST PRICE BY EDGE TREATMENT | | | | | L2 UPCHARGE |
|---|-----------------|-------------|--------|----------------|------------------------------|-------|-------|--------|--------|----------------|
| | | ROUND | SQUARE | SOFT SQUARE | CUBE | "E" | "G" | "J" | "T" | |
| Laminate Round, Square, and Soft Square Tops | | | | | | | | | | |
| 60" Round Top | HTLD60 | 95 | N/A | N/A | 10.1 | \$655 | \$704 | \$1073 | N/A | \$31 |
| 48" Top | HTL(?)48 | 66 | 76 | 80 | 6.3 | \$523 | \$563 | \$908 | \$1061 | \$25 |
| 42" Top | HTL(?)42 | 51 | 61 | 61 | 4.9 | \$466 | \$509 | \$845 | \$928 | \$20 |
| 36" Top | HTL(?)36 | 36 | 46 | 46 | 3.7 | \$408 | \$467 | \$723 | \$837 | \$20 |
| 30" Top | HTL(?)30 | 28 | 33 | 33 | 3.0 | \$369 | \$397 | \$604 | N/A | \$17 |
| 24" Top | HTL(?)24 | 19 | 23 | 23 | 2.1 | \$341 | \$367 | \$559 | N/A | \$16 |

NOTES: Tops are available in three shapes: Round (D), Square (S), and Soft Square (SFT). Replace the (?) shown in each model with D, S, or SFT to specify shape.

❗ 60" top only available in Round (D) shape.

NOTES:

- Tops with E, G, and T edge details feature durable laminate tops over solid core high-performance particleboard. Tops with J edge feature an MDF core.
- Laminate tops with Traditional (T) edge feature high gloss laminate and wood edge to coordinate with 94000 Series Desks.
- Tops with E edge detail have 3" radius corners. All other edge details have 90 degree corners.
- See page 93 for number of cutouts for each table top size.

❗ Tops with Traditional edge available in Mahogany only.

❗ See pages 85-90 for top and base compatibility.

HOW TO SPECIFY

| Select Model Number | Select Edge Detail and Edge Color | Select Cutout Option | Select Laminate |
|---|--|---|--|
| <p>See page 83</p> <p>HTLD48</p> <p>Traditional Edge</p> <p>HTLD48T</p> | <p>See page 83</p> <p>J C</p> <p>N</p> | <p>No Cutout</p> <p>G Cutout for 24" and 30" tops (+ \$15 upcharge)</p> <p>G1 Cutout for Pop-up Port (+ \$40 upcharge per cutout)</p> <p>G2 Cutout for Flip-top Port (+ \$50 upcharge per cutout)</p> <p>G1</p> <p>G1</p> | <p>See page 82, Laminate Group A</p> <p>D</p> <p>N</p> |

PRESIDE® Laminate Bases

GSA SIN 33721



Icon Legend on page 17

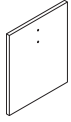

| DESCRIPTION | PANELS INCLUDED PER KIT | MODEL | SHIP WEIGHT | CUBE | LIST PRICE BY LAMINATE GRADE | |
|--|----------------------------|----------------|----------------|------|------------------------------|---------------|
| | | | | | L1 | L2 |
| Laminate Seated-Height Panel Base for Tops 60" or Wider | | | | | | |
| For 240"W Table Tops | 4 | HTLP240 | 197 | 16.4 | \$1496 | \$1576 |
| For 216"W Table Tops | 3 | HTLP216 | 158 | 12.4 | \$1145 | \$1202 |
| For 192"W Table Tops | 3 | HTLP192 | 147 | 11.6 | \$1145 | \$1202 |
| For 180"W Table Tops | 3 | HTLP180 | 147 | 11.6 | \$1145 | \$1202 |
| For 168"W Table Tops | 3 | HTLP168 | 136 | 10.6 | \$998 | \$1053 |
| For 144"W Table Tops | 2 | HTLP144 | 97 | 6.6 | \$647 | \$679 |
| For 120"W Table Tops | 2 | HTLP120 | 86 | 5.8 | \$647 | \$679 |
| For 108"W Table Tops | 2 | HTLP108 | 86 | 5.8 | \$647 | \$679 |
| For 96"W Table Tops | 2 | HTLP96 | 75 | 4.9 | \$647 | \$679 |
| For 84"W Table Tops | 2 | HTLP84 | 75 | 5.0 | \$647 | \$679 |
| For 72"W Table Tops | 2 | HTLP72 | 25 | 2.9 | \$608 | \$640 |
| For 60"W Table Tops | 2 | HTLP60 | 25 | 2.9 | \$608 | \$640 |
| For 72" Adder Section | 1 | HTLPM | 61 | 5.8 | \$498 | \$523 |

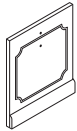

| | | | | | | |
|--|---|----------------|-----|------|---------------|------------|
| Laminate Seated-Height Traditional Panel Base for Tops 72" or Wider | | | | | | |
| For 168"W Table Tops | 3 | HTLT168 | 145 | 12.1 | \$1243 | N/A |
| For 144"W Table Tops | 2 | HTLT144 | 106 | 8.2 | \$892 | N/A |
| For 120"W Table Tops | 2 | HTLT120 | 95 | 7.3 | \$892 | N/A |
| For 96"W Table Tops | 2 | HTLT96 | 62 | 4.6 | \$892 | N/A |
| For 72"W Table Tops | 2 | HTLT72 | 84 | 6.5 | \$818 | N/A |

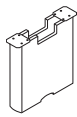

| | | | | | | |
|---|---|-----------------|-----|------|---------------|---------------|
| Laminate Seated-Height Hollow Panel Base for Tops 84" or Wider | | | | | | |
| For 240"W Table Tops | 3 | HTLHP240 | 206 | 17.5 | \$3258 | \$3378 |
| For 216"W Table Tops | 3 | HTLHP216 | 204 | 17.3 | \$3173 | \$3293 |
| For 192"W Table Tops | 3 | HTLHP192 | 202 | 17.1 | \$3101 | \$3221 |
| For 180"W Table Tops | 3 | HTLHP180 | 202 | 17.1 | \$3101 | \$3221 |
| For 168"W Table Tops | 3 | HTLHP168 | 193 | 16.9 | \$3000 | \$3120 |
| For 144"W Table Tops | 2 | HTLHP144 | 133 | 11.4 | \$2059 | \$2139 |
| For 120"W Table Tops | 2 | HTLHP120 | 131 | 11.2 | \$1987 | \$2067 |
| For 108"W Table Tops | 2 | HTLHP108 | 131 | 11.2 | \$1987 | \$2067 |
| For 96"W Table Tops | 2 | HTLHP96 | 125 | 11.0 | \$1915 | \$1995 |
| For 84"W Table Tops | 2 | HTLHP84 | 125 | 11.0 | \$1915 | \$1995 |
| For 72" Adder Section | 1 | HTLHPM | 71 | 5.9 | \$1114 | \$1154 |

NOTES:

- Tops and bases are sold and shipped separately.
- End caps for Hollow Panel bases can be matched to woodgrain finishes or specified in select solid colors.
- Bases ship with appropriate number of supports for table width. See page 92 for details.
- Laminate panel bases feature sturdy 1½" thick x 12"H particleboard support beam in matching finish.
- Traditional panel base for 168"W Top includes two traditional panels and one standard panel.

- ! Traditional style bases available in Mahogany (N) only.
- ! For Base and Top compatibility, see base information on pages 85-92.
- ! Laminate hollow panel bases feature dual aluminum support beams with integrated wire management.

HOW TO SPECIFY**Select
Model Number**

HTLHP240

**Select
Laminate**

See page 82, Laminate Group B

D

**Select
Endcap/Inlay Option**See page 82, Laminate Group C
(Specify for Hollow Panel Bases only)

LFW1



PRESIDE® Laminate Bases

| DESCRIPTION | PANELS INCLUDED | | SHIP WEIGHT | CUBE | LIST PRICE BY LAMINATE GRADE | |
|--|-----------------|--------------------|-------------|------|------------------------------|---------------|
| | PER KIT | MODEL | | | L1 | L2 |
| Laminate Seated-Height Cube Base for Tops 84" or Wider | | | | | | |
| For 240"W Table Tops | 3 | HTLCUBE240 | 278 | 29.2 | \$3900 | \$4035 |
| For 216"W Table Tops | 3 | HTLCUBE216 | 276 | 29.0 | \$3815 | \$3950 |
| For 192"W Table Tops | 3 | HTLCUBE192 | 274 | 28.8 | \$3743 | \$3878 |
| For 180"W Table Tops | 3 | HTLCUBE180 | 274 | 28.8 | \$3743 | \$3878 |
| For 168"W Table Tops | 2 | HTLCUBE168 | 183 | 19.4 | \$2572 | \$2662 |
| For 144"W Table Tops | 2 | HTLCUBE144 | 181 | 19.2 | \$2487 | \$2577 |
| For 120"W Table Tops | 2 | HTLCUBE120 | 179 | 19.0 | \$2415 | \$2505 |
| For 108"W Table Tops | 2 | HTLCUBE108 | 179 | 19.0 | \$2415 | \$2505 |
| For 96"W Table Tops | 2 | HTLCUBE96 | 164 | 18.2 | \$2140 | \$2230 |
| For 84"W Table Tops | 2 | HTLCUBE84 | 164 | 18.2 | \$2140 | \$2230 |
| For 72" Adder Section | 1 | HTLCUBEM | 95 | 9.8 | \$1328 | \$1373 |
| Laminate Standing-Height Cube Base for Tops 48" or Wider | | | | | | |
| For 240"W Table Tops | 3 | HTLCUBES240 | 302 | 45.7 | \$4716 | \$4881 |
| For 216"W Table Tops | 3 | HTLCUBES216 | 300 | 45.5 | \$4631 | \$4796 |
| For 192"W Table Tops | 3 | HTLCUBES192 | 298 | 45.3 | \$4559 | \$4724 |
| For 180"W Table Tops | 3 | HTLCUBES180 | 298 | 45.3 | \$4559 | \$4724 |
| For 168"W Table Tops | 2 | HTLCUBES168 | 199 | 30.4 | \$3116 | \$3226 |
| For 144"W Table Tops | 2 | HTLCUBES144 | 197 | 30.2 | \$3031 | \$3141 |
| For 120"W Table Tops | 2 | HTLCUBES120 | 195 | 30.0 | \$2959 | \$3069 |
| For 108"W Table Tops | 2 | HTLCUBES108 | 195 | 30.0 | \$2959 | \$3069 |
| For 96"W Table Tops | 2 | HTLCUBES96 | 180 | 29.2 | \$2684 | \$2794 |
| For 72" Adder | 1 | HTLCUBESM | 103 | 15.3 | \$1600 | \$1655 |
| Laminate Seated-Height Cylinder Base for Tops 84" or Wider | | | | | | |
| For 240"W Table Tops | 3 | HTLR240 | 191 | 51.9 | \$3159 | \$3264 |
| For 216"W Table Tops | 3 | HTLR216 | 189 | 51.7 | \$3074 | \$3179 |
| For 192"W Table Tops | 3 | HTLR192 | 187 | 51.5 | \$3002 | \$3107 |
| For 180"W Table Tops | 3 | HTLR180 | 187 | 51.5 | \$3002 | \$3107 |
| For 168"W Table Tops | 2 | HTLR168 | 125 | 34.5 | \$2078 | \$2148 |
| For 144"W Table Tops | 2 | HTLR144 | 123 | 34.3 | \$1993 | \$2063 |
| For 120"W Table Tops | 2 | HTLR120 | 121 | 34.1 | \$1921 | \$1991 |
| For 108"W Table Tops | 2 | HTLR108 | 121 | 34.1 | \$1921 | \$1991 |
| For 96"W Table Tops | 2 | HTLR96 | 106 | 33.3 | \$1646 | \$1716 |
| For 84"W Table Tops | 2 | HTLR84 | 106 | 33.3 | \$1646 | \$1716 |
| For 72" Adder Section | 1 | HTLRM | 66 | 17.4 | \$1081 | \$1116 |
| Laminate Seated-Height Cylinder Base with Wire Management for Tops 84" or Wider | | | | | | |
| For 240"W Table Tops | 3 | HTLRC240 | 191 | 51.9 | \$4107 | \$4242 |
| For 216"W Table Tops | 3 | HTLRC216 | 189 | 51.7 | \$4022 | \$4157 |
| For 192"W Table Tops | 3 | HTLRC192 | 187 | 51.4 | \$3950 | \$4085 |
| For 180"W Table Tops | 3 | HTLRC180 | 187 | 51.4 | \$3950 | \$4085 |
| For 168"W Table Tops | 2 | HTLRC168 | 125 | 34.5 | \$2710 | \$2800 |
| For 144"W Table Tops | 2 | HTLRC144 | 123 | 34.3 | \$2625 | \$2715 |
| For 120"W Table Tops | 2 | HTLRC120 | 121 | 34.1 | \$2553 | \$2643 |
| For 108"W Table Tops | 2 | HTLRC108 | 121 | 34.1 | \$2553 | \$2643 |
| For 96"W Table Tops | 2 | HTLRC96 | 106 | 33.3 | \$2278 | \$2368 |
| For 84"W Table Tops | 2 | HTLRC84 | 106 | 33.3 | \$2278 | \$2368 |
| For 72" Adder | 1 | HTLRM | 66 | 17.4 | \$1397 | \$1442 |

NOTES:

- Tops and bases are sold and shipped separately.
- Bases ship with appropriate number of supports for table width. See page 92 for details.
- Standing-Height Cube Bases are 39"H.
- Laminate cube and cylinder bases for tops 108"W and greater feature dual aluminum support beams with integrated wire management.
- Cube bases feature removable door to allow access to cables and enable wire routing.
- Standing-Height Bases feature a hinged door for easy access and for cable routing through the base.

① Seated Cube Base requires 150 lbs. of sand or other ballast in each base for stability (not supplied). Standing-Height Cube Base does not require additional ballast.

② For Base and Top compatibility, see base information on pages 85-92.

HOW TO SPECIFY

| | |
|---|--|
| <p>Select Model Number</p> <p>HTLCUBE180</p> | <p>Select Laminate</p> <p>See page 82, Laminate Group B</p> <p>LFW1</p> |
|---|--|

PRESIDE[®] Metal Bases

OPEN MARKET



Icon Legend on page 17

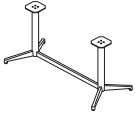

| DESCRIPTION | MODEL | SHIP WEIGHT | CUBE | LIST PRICE BY PAINT GRADE | | |
|--|--------------------|-------------|------|---------------------------|---------------|---------------|
| | | | | P1 | P2 | P3 |
| Footed Y-Base for Tops 60" or Wider | | | | | | |
| 42½"H Standing Height Base for 42" and 48" x 240" Tops | HT42FB48240 | 88 | 10.8 | \$2697 | \$2947 | \$3073 |
| 42½"H Standing Height Base for 42" and 48" x 216" Tops | HT42FB48216 | 85 | 10.4 | \$2578 | \$2818 | \$2938 |
| 42½"H Standing Height Base for 42" and 48" x 192" Tops | HT42FB48192 | 82 | 10.1 | \$2484 | \$2715 | \$2830 |
| 42½"H Standing Height Base for 42" and 48" x 180" Tops | HT42FB48180 | 82 | 10.1 | \$2484 | \$2715 | \$2830 |
| 42½"H Standing Height Base for 42" and 48" x 168" Tops | HT42FB48168 | 67 | 9.3 | \$1907 | \$2084 | \$2173 |
| 36½"H Counter Height Base for 42" and 48" x 240" Tops | | | | | | |
| 36½"H Counter Height Base for 42" and 48" x 216" Tops | HT36FB48240 | 86 | 10.8 | \$2633 | \$2879 | \$3001 |
| 36½"H Counter Height Base for 42" and 48" x 192" Tops | HT36FB48192 | 80 | 10.1 | \$2420 | \$2647 | \$2758 |
| 36½"H Counter Height Base for 42" and 48" x 180" Tops | HT36FB48180 | 80 | 10.1 | \$2420 | \$2647 | \$2758 |
| 36½"H Counter Height Base for 42" and 48" x 168" Tops | HT36FB48168 | 65 | 9.3 | \$1859 | \$2033 | \$2119 |
| 29½"H Seated Height Base for 42" and 48" x 240" Tops | | | | | | |
| 29½"H Seated Height Base for 42" and 48" x 216" Tops | HT29FB48216 | 81 | 10.4 | \$2450 | \$2678 | \$2794 |
| 29½"H Seated Height Base for 42" and 48" x 192" Tops | HT29FB48192 | 78 | 10.1 | \$2356 | \$2575 | \$2686 |
| 29½"H Seated Height Base for 42" and 48" x 180" Tops | HT29FB48180 | 78 | 10.1 | \$2356 | \$2575 | \$2686 |
| 29½"H Seated Height Base for 42" and 48" x 168" Tops | HT29FB48168 | 63 | 9.3 | \$1811 | \$1979 | \$2065 |
| 27¼"H Working Lounge Base for 42" and 48" x 240" Tops | | | | | | |
| 27¼"H Working Lounge Base for 42" and 48" x 216" Tops | HT27FB48216 | 79 | 10.4 | \$2410 | \$2634 | \$2746 |
| 27¼"H Working Lounge Base for 42" and 48" x 192" Tops | HT27FB48192 | 76 | 10.1 | \$2316 | \$2531 | \$2638 |
| 27¼"H Working Lounge Base for 42" and 48" x 180" Tops | HT27FB48180 | 76 | 10.1 | \$2316 | \$2531 | \$2638 |
| 27¼"H Working Lounge Base for 42" and 48" x 168" Tops | HT27FB48168 | 61 | 9.3 | \$1781 | \$1946 | \$2029 |

NOTES:

- Tops and bases are sold and shipped separately.
- Bases ship with appropriate number of supports for table width.
- ⚠ Footed base not to be used on 54"D conference tables.
- ⚠ See pages 85-90 for top and base compatibility.
- ⚠ Footed Y-base for tops 84"W or greater feature dual aluminum support beams with integrated wire management. Footed Y-base for 60"W and 72"W tops do not include aluminum beams.

HOW TO SPECIFY

| | |
|--|--|
| <p>Select Model Number</p> <p>HT27FB48168</p> | <p>Select Paint Color</p> <p>See page 82, Paint Group A</p> <p>T1</p> |
|--|--|



Icon Legend on page 17

PRESIDE® Metal Bases

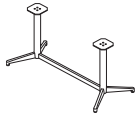

DESCRIPTION

MODEL

SHIP WEIGHT CUBE

LIST PRICE BY PAINT GRADE
P1 P2 P3

Footed Y-Base for Tops 60" or Wider

| | | | | | | |
|--|--------------------|----|-----|--------|--------|--------|
| 42½"H Standing Height Base for 42" and 48" x 144" Tops | HT42FB48144 | 64 | 8.9 | \$1788 | \$1955 | \$2038 |
| 42½"H Standing Height Base for 42" and 48" x 120" Tops | HT42FB48120 | 61 | 8.7 | \$1694 | \$1852 | \$1930 |
| 42½"H Standing Height Base for 42" and 48" x 108" Tops | HT42FB48108 | 61 | 8.7 | \$1694 | \$1852 | \$1930 |
| 42½"H Standing Height Base for 42" and 48" x 96" Tops | HT42FB4896 | 37 | 4.9 | \$1146 | \$1252 | \$1306 |
| 42½"H Standing Height Base for 42" x 84" Tops | HT42FB4284 | 36 | 4.8 | \$1129 | \$1234 | \$1287 |
| 42½"H Standing Height Base for 36" x 72" Tops | HT42FB3672 | 27 | 4.2 | \$1019 | \$1105 | \$1148 |
| 42½"H Standing Height Base for 30" x 60" Tops | HT42FB3060 | 25 | 4.2 | \$893 | \$976 | \$1018 |

| | | | | | | |
|---|--------------------|----|-----|--------|--------|--------|
| 36½"H Counter Height Base for 42" and 48" x 144" Tops | HT36FB48144 | 62 | 8.9 | \$1740 | \$1904 | \$1984 |
| 36½"H Counter Height Base for 42" and 48" x 120" Tops | HT36FB48120 | 59 | 8.7 | \$1646 | \$1801 | \$1876 |
| 36½"H Counter Height Base for 42" and 48" x 108" Tops | HT36FB48108 | 59 | 8.7 | \$1646 | \$1801 | \$1876 |
| 36½"H Counter Height Base for 42" and 48" x 96" Tops | HT36FB4896 | 36 | 4.9 | \$1114 | \$1218 | \$1270 |
| 36½"H Counter Height Base for 42" x 84" Tops | HT36FB4284 | 35 | 4.8 | \$1097 | \$1200 | \$1251 |
| 36½"H Counter Height Base for 36" x 72" Tops | HT36FB3672 | 26 | 4.2 | \$987 | \$1071 | \$1112 |
| 36½"H Counter Height Base for 30" x 60" Tops | HT36FB3060 | 24 | 4.2 | \$863 | \$944 | \$984 |

| | | | | | | |
|--|--------------------|----|-----|--------|--------|--------|
| 29½"H Seated Height Base for 42" and 48" x 144" Tops | HT29FB48144 | 60 | 8.9 | \$1692 | \$1850 | \$1930 |
| 29½"H Seated Height Base for 42" and 48" x 120" Tops | HT29FB48120 | 57 | 8.7 | \$1598 | \$1747 | \$1822 |
| 29½"H Seated Height Base for 42" and 48" x 108" Tops | HT29FB48108 | 57 | 8.7 | \$1598 | \$1747 | \$1822 |
| 29½"H Seated Height Base for 42" and 48" x 96" Tops | HT29FB4896 | 35 | 4.9 | \$1082 | \$1182 | \$1234 |
| 29½"H Seated Height Base for 42" x 84" Tops | HT29FB4284 | 34 | 4.8 | \$1065 | \$1164 | \$1215 |
| 29½"H Seated Height Base for 36" x 72" Tops | HT29FB3672 | 25 | 4.2 | \$955 | \$1035 | \$1076 |
| 29½"H Seated Height Base for 30" x 60" Tops | HT29FB3060 | 23 | 4.2 | \$831 | \$908 | \$946 |

| | | | | | | |
|---|--------------------|----|-----|--------|--------|--------|
| 27¼"H Working Lounge Base for 42" and 48" x 144" Tops | HT27FB48144 | 58 | 8.9 | \$1662 | \$1817 | \$1894 |
| 27¼"H Working Lounge Base for 42" and 48" x 120" Tops | HT27FB48120 | 55 | 8.7 | \$1568 | \$1714 | \$1786 |
| 27¼"H Working Lounge Base for 42" and 48" x 108" Tops | HT27FB48108 | 55 | 8.7 | \$1568 | \$1714 | \$1786 |
| 27¼"H Working Lounge Base for 42" and 48" x 96" Tops | HT27FB4896 | 34 | 4.9 | \$1062 | \$1160 | \$1210 |
| 27¼"H Working Lounge Base for 42" x 84" Tops | HT27FB4284 | 33 | 4.8 | \$1045 | \$1142 | \$1191 |
| 27¼"H Working Lounge Base for 36" x 72" Tops | HT27FB3672 | 24 | 4.2 | \$935 | \$1013 | \$1052 |
| 27¼"H Working Lounge Base for 30" x 60" Tops | HT27FB3060 | 22 | 4.2 | \$809 | \$884 | \$922 |

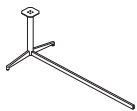

Footed Base Adder for 72"W or Wider Tops

| | | | | | | |
|------|----------------|----|-----|--------|--------|--------|
| 42"H | HT42FBM | 40 | 4.9 | \$1820 | \$1940 | \$2000 |
| 36"H | HT36FBM | 39 | 4.9 | \$1772 | \$1890 | \$1948 |
| 29"H | HT29FBM | 38 | 4.9 | \$1724 | \$1838 | \$1896 |
| 27"H | HT27FBM | 37 | 4.9 | \$1694 | \$1806 | \$1862 |



Wire Manager

| | | | | | | |
|---------------------------------------|------------------|---|-----|-------|-------|-------|
| Manager for 42"H Footed Base — 1-Pack | HTFWMGR42 | 2 | 0.3 | \$157 | \$172 | \$179 |
| Manager for 36"H Footed Base — 1-Pack | HTFWMGR36 | 1 | 0.3 | \$148 | \$162 | \$169 |
| Manager for 29"H Footed Base — 1-Pack | HTFWMGR29 | 1 | 0.4 | \$140 | \$153 | \$160 |
| Manager for 27"H Footed Base — 1-Pack | HTFWMGR27 | 1 | 0.4 | \$131 | \$143 | \$149 |

NOTES:

- Tops and bases are sold and shipped separately.
- Bases ship with appropriate number of supports for table width.
- To conceal any power cords from table top to floor, specify wire manager based on table height. Wire manager adheres to the vertical column of the base.
- ❗ Footed base not to be used on 54"D conference tables.
- ❗ See pages 85-90 for top and base compatibility.
- ❗ Footed Y-base for tops 84"W or greater feature dual aluminum support beams with integrated wire management. Footed Y-base for 60"W and 72"W tops do not include aluminum beams.

HOW TO SPECIFY

| | |
|--|--|
| <p>Select Model Number</p> <p>HT29FB48144</p> | <p>Select Paint Color</p> <p>See page 82, Paint Group A</p> <p>T1</p> |
|--|--|

PRESIDE® Metal Bases

GSA SIN 33721 EXCEPT AS NOTED



Icon Legend on page 17

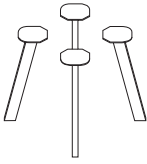

OPEN MARKET

| DESCRIPTION | MODEL | SHIP | | LIST PRICE BY PAINT GRADE | | |
|---|------------|--------|------|---------------------------|--------|--------|
| | | WEIGHT | CUBE | P1 | P2 | P3 |
| Angled Leg | | | | | | |
| 42½" H Standing Height Base for Round, Square, and Soft Square Tops | HT42ALEG | 32 | 2.6 | \$1726 | \$1886 | \$1966 |
| 29½" H Seated Height Base for Round, Square, and Soft Square Tops | HT29ALEG | 25 | 2.6 | \$1404 | \$1534 | \$1600 |
| 42½" H Standing Height Base for 96" W Tops | HT42AL96 | 32 | 2.6 | \$2589 | \$2829 | \$2949 |
| 42½" H Standing Height Base for 84" W Tops | HT42AL84 | 41 | 3.1 | \$1929 | \$2108 | \$2198 |
| 42½" H Standing Height Base for 72" W Tops | HT42AL72 | 32 | 2.6 | \$1726 | \$1886 | \$1966 |
| 42½" H Standing Height Base for 60" W Tops | HT42AL60 | 32 | 2.6 | \$1726 | \$1886 | \$1966 |
| 29½" H Seated Height Base for 240" W Tops | HT29AL240 | 57 | 4.5 | \$3498 | \$3823 | \$3987 |
| 29½" H Seated Height Base for 216" W Tops | HT29AL216 | 55 | 4.2 | \$3413 | \$3730 | \$3890 |
| 29½" H Seated Height Base for 192" W Tops | HT29AL192 | 53 | 4.0 | \$3341 | \$3651 | \$3808 |
| 29½" H Seated Height Base for 180" W Tops | HT29AL180 | 53 | 4.0 | \$3341 | \$3651 | \$3808 |
| 29½" H Seated Height Base for 168" W Tops | HT29AL168 | 44 | 3.8 | \$2538 | \$2774 | \$2893 |
| 29½" H Seated Height Base for 144" W Tops | HT29AL144 | 42 | 3.5 | \$2453 | \$2681 | \$2796 |
| 29½" H Seated Height Base for 120" W Tops | HT29AL120 | 40 | 3.3 | \$2381 | \$2602 | \$2714 |
| 29½" H Seated Height Base for 108" W Tops | HT29AL108 | 40 | 3.3 | \$2381 | \$2602 | \$2714 |
| 29½" H Seated Height Base for 96" W Tops | HT29AL96 | 37 | 3.3 | \$1609 | \$1756 | \$1831 |
| 29½" H Seated Height Base for 84" W Tops | HT29AL84 | 34 | 3.1 | \$1607 | \$1756 | \$1832 |
| 29½" H Seated Height Base for 72" W Tops | HT29AL72 | 25 | 2.6 | \$1404 | \$1534 | \$1600 |
| 29½" H Seated Height Base for 60" W Tops | HT29AL60 | 25 | 2.6 | \$1404 | \$1534 | \$1600 |
| 29½" H Seated Height Base for 72" W Adder | HT29ALM | 38 | 3.3 | \$960 | \$1049 | \$1094 |
| Wire Manager | | | | | | |
| Angled Leg Wire Manager for 42½" H Leg | HTALWMGR42 | 3 | 4.0 | \$104 | \$114 | \$119 |
| Angled Leg Wire Manager for 29½" H Leg | HTALWMGR29 | 2 | 4.0 | \$82 | \$90 | \$94 |



OPEN MARKET

| DESCRIPTION | LEGS INCLUDED PER KIT | MODEL | SHIP | | LIST PRICE BY PAINT GRADE | | |
|---|-----------------------|-----------|--------|------|---------------------------|--------|--------|
| | | | WEIGHT | CUBE | P1 | P2 | P3 |
| Aluminum T-Leg for Tops 60" or Wider | | | | | | | |
| For 240" W Table Tops | 4 | HTTLEG240 | 76 | 8.9 | \$2042 | \$2082 | \$2102 |
| For 216" W Table Tops | 3 | HTTLEG216 | 65 | 8.6 | \$1632 | \$1672 | \$1692 |
| For 192" W Table Tops | 3 | HTTLEG192 | 63 | 8.4 | \$1560 | \$1600 | \$1620 |
| For 180" W Table Tops | 3 | HTTLEG180 | 63 | 8.4 | \$1560 | \$1600 | \$1620 |
| For 168" W Table Tops | 3 | HTTLEG168 | 54 | 8.2 | \$1459 | \$1499 | \$1519 |
| For 144" W Table Tops | 2 | HTTLEG144 | 39 | 4.5 | \$1023 | \$1043 | \$1053 |
| For 120" W Table Tops | 2 | HTTLEG120 | 37 | 4.3 | \$951 | \$971 | \$981 |
| For 108" W Table Tops | 2 | HTTLEG108 | 37 | 4.2 | \$951 | \$971 | \$981 |
| For 96" W Table Tops | 2 | HTTLEG96 | 31 | 4.0 | \$879 | \$899 | \$909 |
| For 84" W Table Tops | 2 | HTTLEG84 | 31 | 4.0 | \$879 | \$899 | \$909 |
| For 72" W Table Tops | 2 | HTTLEG72 | 26 | 3.5 | \$676 | \$696 | \$706 |
| For 60" W Table Tops | 2 | HTTLEG60 | 22 | 3.5 | \$676 | \$696 | \$706 |
| For 72" Adder Section | 1 | HTTLEGM | 26 | 4.2 | \$609 | N/A | N/A |

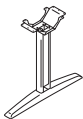

NOTES:

- Tops and bases are sold and shipped separately.
- Bases ship with appropriate number of supports for table width.
- To conceal any power cords from table top to floor, specify wire manager based on table height. Angled leg wire manager is friction fit with magnets to hold in place.
- ❗ Aluminum T-legs for tops 84" and greater feature dual aluminum support beams with integrated wire management. Aluminum T-legs for 60" and 72" tops do not include aluminum beams.
- ❗ Footed base not to be used on 54"D conference tables.
- ❗ See pages 85-90 for top and base compatibility.

HOW TO SPECIFY

| | |
|---------------------|----------------------------|
| Select Model Number | Select Paint Color |
| HT42ALEG | See page 82, Paint Group A |
| PR6 | |



PRESIDE® Laminate Bases

| | DESCRIPTION | BASES INCLUDED | | SHIP WEIGHT | CUBE | LIST PRICE BY LAMINATE GRADE | |
|---|---|----------------|-------------------|-------------|------|------------------------------|---------------|
| | | PER KIT | MODEL | | | L1 | L2 |
| | Laminate Cube Base for Round, Square, and Soft Square Tops | | | | | | |
| | For 60" Round and all 48" Tops, Seated-Height | 1 | HTLCUBE48 | 82 | 9.1 | \$1070 | \$1115 |
| | For 60" Round and all 48" Tops, Standing-Height | 1 | HTLCUBES48 | 90 | 14.6 | \$1342 | \$1397 |
| | Laminate Cylinder Base for Round, Square, and Soft Square Tops | | | | | | |
| | For 48" Tops | 1 | HTLR48 | 53 | 16.7 | \$823 | \$858 |
| | For 42" Tops | 1 | HTLR42 | 42 | 11.6 | \$743 | \$778 |
| | For 36" Tops | 1 | HTLR36 | 42 | 11.6 | \$743 | \$778 |
| <i>Used with 36" and 42" table tops</i> | For 48" Tops, with Wire Management | 1 | HTLRC48 | 53 | 16.7 | \$1139 | \$1184 |
| | Laminate Panel X-Base | 1 | HTLXP48 | 54 | 5.2 | \$478 | \$498 |
| | | 1 | HTLXP42 | 54 | 5.2 | \$478 | \$498 |
| | | 1 | HTLXP36 | 47 | 4.7 | \$445 | \$465 |
| | NOTES: Can be used with 36", 42" and 48" Round and Soft Square Tops, and 36" and 42" Square Tops. | | | | | | |
| | Not compatible with cutouts or power ports. | | | | | | |

NOTES:

- Tops and bases are sold and shipped separately.
- Cube Base features removable door for wire management.
- Cube Base requires 150 lbs. of sand or other ballast in each base for stability (not supplied).
- See pages 85-90 for top and base compatibility.

HOW TO SPECIFY

| | |
|--|---|
| <p>Select Model Number</p> <p>H T L C U B E 4 8</p> | <p>Select Laminate</p> <p>See page 82, Laminate Group B</p> <p>D</p> |
|--|---|

PRESIDE® Metal Bases

GSA SIN 33721 EXCEPT AS NOTED



Icon Legend on page 17



DESCRIPTION

Aluminum X-Leg Base for Round, Square, and Soft Square Tops

MODEL

HTXLEG

SHIP WEIGHT

16

CUBE

3.5

LIST PRICE

\$536

P2 LIST PRICE

\$556



Standing-Height Aluminum X-Leg Base for 36" and 42" Round, Square, and Soft Square Tops

HTXLEGSH

17

3.5

\$669

\$689



OPEN MARKET

DESCRIPTION

Footed Café X-Base

42½"H Standing Height X-Base for 48" Tops
 42½"H Standing Height X-Base for 36" and 42" Tops
 42½"H Standing Height X-Base for 30" Tops
 36½"H Counter Height X-Base for 48" Tops
 36½"H Counter Height X-Base for 36" and 42" Tops
 36½"H Counter Height X-Base for 30" Tops
 29½"H Seated Height X-Base for 48" and 60" Tops
 29½"H Seated Height X-Base for 36" and 42" Tops
 29½"H Seated Height X-Base for 30" Tops
 29½"H Seated Height X-Base for 24" Tops
 27¼"H Working Lounge X-Base for 48" and 60" Tops
 27¼"H Working Lounge X-Base for 36" and 42" Tops
 27¼"H Working Lounge X-Base for 30" Tops
 27¼"H Working Lounge X-Base for 24" Tops

MODEL

HTFXL42
 HTFXM42
 HTFXS42
 HTFXL36
 HTFXM36
 HTFXS36
 HTFXL29
 HTFXM29
 HTFXS29
 HTFXT29
 HTFXL27
 HTFXM27
 HTFXS27
 HTFXT27

SHIP WEIGHT

32
 31
 30
 31
 30
 29
 30
 29
 28
 27
 29
 28
 27
 26

CUBE

3.7
 3.7
 3.7
 3.7
 3.7
 3.7
 3.7
 3.7
 3.7
 3.7
 3.7
 3.7
 3.7
 3.7

LIST PRICE BY PAINT GRADE

| P1 | P2 | P3 |
|-------|-------|-------|
| \$740 | \$809 | \$843 |
| \$676 | \$739 | \$770 |
| \$579 | \$633 | \$660 |
| \$692 | \$756 | \$788 |
| \$625 | \$683 | \$712 |
| \$541 | \$591 | \$616 |
| \$616 | \$673 | \$702 |
| \$568 | \$621 | \$647 |
| \$503 | \$550 | \$573 |
| \$460 | \$503 | \$524 |
| \$563 | \$615 | \$641 |
| \$513 | \$561 | \$585 |
| \$455 | \$497 | \$518 |
| \$432 | \$472 | \$492 |

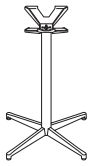

OPEN MARKET

Footed Café X-Base w/Power

42½"H Standing Height X-Base for 48" Tops
 42½"H Standing Height X-Base for 36" and 42" Tops
 42½"H Standing Height X-Base for 30" Tops
 36½"H Counter Height X-Base for 48" Tops
 36½"H Counter Height X-Base for 36" and 42" Tops
 36½"H Counter Height X-Base for 30" Tops
 29½"H Seated Height X-Base for 48" and 60" Tops
 29½"H Seated Height X-Base for 36" and 42" Tops
 29½"H Seated Height X-Base for 30" Tops
 29½"H Seated Height X-Base for 24" Tops
 27¼"H Working Lounge X-Base for 48" and 60" Tops
 27¼"H Working Lounge X-Base for 36" and 42" Tops
 27¼"H Working Lounge X-Base for 30" Tops
 27¼"H Working Lounge X-Base for 24" Tops

HTFXL42P
 HTFXM42P
 HTFXS42P
 HTFXL36P
 HTFXM36P
 HTFXS36P
 HTFXL29P
 HTFXM29P
 HTFXS29P
 HTFXT29P
 HTFXL27P
 HTFXM27P
 HTFXS27P
 HTFXT27P

32
 31
 30
 31
 31
 29
 30
 29
 28
 27
 29
 28
 27
 26

3.7
 3.7
 3.7
 3.7
 3.7
 3.7
 3.7
 3.7
 3.7
 3.7
 3.7
 3.7
 3.7
 3.7

| P1 | P2 | P3 |
|-------|-------|-------|
| \$740 | \$809 | \$843 |
| \$676 | \$739 | \$770 |
| \$579 | \$633 | \$660 |
| \$692 | \$756 | \$788 |
| \$625 | \$683 | \$712 |
| \$541 | \$591 | \$616 |
| \$616 | \$673 | \$702 |
| \$568 | \$621 | \$647 |
| \$503 | \$550 | \$573 |
| \$460 | \$503 | \$524 |
| \$563 | \$615 | \$641 |
| \$513 | \$561 | \$585 |
| \$455 | \$497 | \$518 |
| \$432 | \$472 | \$492 |



OPEN MARKET

Footed Café X-Base w/Casters

42½"H Standing Height X-Base for 48" Tops
 42½"H Standing Height X-Base for 36" and 42" Tops
 36½"H Counter Height X-Base for 48" Tops
 36½"H Counter Height X-Base for 36" and 42" Tops
 29½"H Seated Height X-Base for 48" Tops
 29½"H Seated Height X-Base for 36" and 42" Tops
 27¼"H Working Lounge X-Base for 48" Tops
 27¼"H Working Lounge X-Base for 36" and 42" Tops

HTFXL42C
 HTFXM42C
 HTFXL36C
 HTFXM36C
 HTFXL29C
 HTFXM29C
 HTFXL27C
 HTFXM27C

32
 31
 31
 30
 30
 29
 29
 28

3.7
 3.7
 3.7
 3.7
 3.7
 3.7
 3.7
 3.7

| P1 | P2 | P3 |
|-------|-------|-------|
| \$767 | \$838 | \$874 |
| \$702 | \$767 | \$800 |
| \$719 | \$786 | \$819 |
| \$652 | \$713 | \$743 |
| \$643 | \$703 | \$733 |
| \$594 | \$649 | \$677 |
| \$589 | \$644 | \$671 |
| \$541 | \$591 | \$616 |

NOTES:

- Tops and bases are sold and shipped separately.
- HTXLEG and HTXLEGSH allow wires to pass through the center of the leg.
- Grommet cutouts not compatible with Footed Café X-Base and Footed Café X-Base with Casters.
- ! Footed Café X-Base with Power allows wires to pass through the center of the leg except when using HTPWRGROM2.
- ! Cannot specify grommet cutouts in top when using footed X-base and footed X-base with casters. Utilize footed X-base with power for situations where power/grommet cutouts are needed.
- ! See pages 85-90 for top and base compatibility.

HOW TO SPECIFY

| | |
|---|--|
| <p>Select Model Number</p> <p>HTFXL42</p> | <p>Select Paint Color</p> <p>See page 82, Paint Group A</p> <p>PJW</p> |
|---|--|



Icon Legend on page 17

PRESIDE® Collaborative Tables

| | DESCRIPTION | MODEL | SHIP WEIGHT | CUBE | LIST PRICE BY LAMINATE GRADE | |
|--|---|----------------------|-------------|------|------------------------------|---------------|
| | | | | | L1 | L2 |
| | Seated-Height, Collaborative Table with Partial Modesty Panel | | | | | |
| | 60"W x 42"D | HTLC4260LCTP | 152 | 2.8 | \$1246 | \$1268 |
| | 72"W x 42"D | HTLC4272LCTP | 167 | 14.5 | \$1483 | \$1513 |
| | 96"W x 42"D | HTLC4296LCTP | 122 | 18.3 | \$1827 | \$1857 |
| | Standing-Height, Collaborative Table with Partial Modesty Panel | | | | | |
| | 60"W x 42"D | HTLC4260HCTP | 187 | 3.7 | \$1424 | \$1446 |
| | 72"W x 42"D | HTLC4272HCTP | 187 | 15.7 | \$1661 | \$1691 |
| | 96"W x 42"D | HTLC4296HCTP | 242 | 19.4 | \$2005 | \$2035 |
| | Seated-Height, Collaborative Table with Full Modesty Panel | | | | | |
| | 60"W x 42"D | HTLC4260LCTFP | 167 | 13.4 | \$1246 | \$1268 |
| | 72"W x 42"D | HTLC4272LCTFP | 175 | 14.9 | \$1483 | \$1513 |
| | 96"W x 42"D | HTLC4296LCTFP | 233 | 18.8 | \$1827 | \$1857 |
| | Standing-Height, Collaborative Table with Full Modesty Panel | | | | | |
| | 60"W x 42"D | HTLC4260HCTFP | 202 | 17.0 | \$1424 | \$1446 |
| | 72"W x 42"D | HTLC4272HCTFP | 211 | 17.9 | \$1661 | \$1691 |
| | 96"W x 42"D | HTLC4296HCTFP | 275 | 22.4 | \$2005 | \$2035 |
| | Seated-Height, Collaborative Table with Power Management, No Modesty Panel | | | | | |
| | 60"W x 42"D | HTLC4260LCTHP | 153 | 10.8 | \$1546 | \$1568 |
| | 72"W x 42"D | HTLC4272LCTHP | 196 | 13.6 | \$1781 | \$1811 |
| | 96"W x 42"D | HTLC4296LCTHP | 244 | 16.0 | \$2124 | \$2154 |
| | NOTES: Wire management available underneath top and through the base. Bases include a removable door to access cords at any time. | | | | | |
| | Standing-Height, Collaborative Table with Power Management, No Modesty Panel | | | | | |
| | 60"W x 42"D | HTLC4260HCTHP | 173 | 12.0 | \$1898 | \$1920 |
| | 72"W x 42"D | HTLC4272HCTHP | 236 | 15.8 | \$2133 | \$2163 |
| | 96"W x 42"D | HTLC4296HCTHP | 284 | 18.3 | \$2476 | \$2506 |
| | NOTES: Wire management available underneath top and through the base. Bases include a removable door to access cords at any time. | | | | | |

NOTES:

- Tops feature 2mm flat edge.
- Partial modesty models will feature different modesty heights than units produced on or before March 16, 2020.
- ! Tables with partial and full modesty panels always feature cutout in modesty panel to accommodate grommet inserts in the top. However, top cutout is optional. Wire management is not included in legs.
- ! Collaborative Tables with power management will not have modesty panels.

HOW TO SPECIFY

| | | | | | |
|---|---|---|--|---|---|
| <p>Select Model Number</p> <p>HTLC4272LCTP</p> | <p>Select Cutout Option</p> <p>N No Cutout G1 Cutout for Pop-up Port (\$40 upcharge) G2 Cutout for Flip-top Port (\$50 upcharge)</p> <p>N</p> | <p>Select Top Laminate Color</p> <p>See page 82, Laminate Group A</p> <p>H</p> | <p>Select Base Laminate Color</p> <p>See page 82, Laminate Group B</p> <p>H</p> | <p>Select Modesty Laminate Color</p> <p>See page 82, Laminate Group B</p> <p><i>Do not specify for Power Management models</i></p> <p>LDW1</p> | <p>Select 2mm Edge Color</p> <p>See page 83</p> <p>H</p> |
|---|---|---|--|---|---|

PRESIDE® Ganging Tables

OPEN MARKET



Icon Legend on page 17

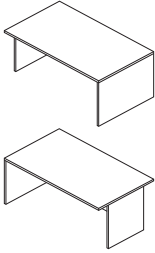

| DESCRIPTION | MODEL | SHIP WEIGHT | CUBE | LIST PRICE BY LAMINATE GRADE | |
|--|---------------|-------------|------|------------------------------|--------|
| | | | | L1 | L2 |
| Seated-Height, Partial Modesty — Full Right Leg | | | | | |
| 60"W x 42"D | HTLC4260LCTPR | 165 | 13.8 | \$1254 | \$1276 |
| 72"W x 42"D | HTLC4272LCTPR | 170 | 14.2 | \$1491 | \$1521 |
| 96"W x 42"D | HTLC4296LCTPR | 223 | 38.9 | \$1835 | \$1878 |
| Seated-Height, Partial Modesty — Full Left Leg | | | | | |
| 60"W x 42"D | HTLC4260LCTPL | 165 | 13.8 | \$1254 | \$1276 |
| 72"W x 42"D | HTLC4272LCTPL | 170 | 14.2 | \$1491 | \$1521 |
| 96"W x 42"D | HTLC4296LCTPL | 223 | 38.9 | \$1835 | \$1878 |
| Standing-Height, Partial Modesty — Full Right Leg | | | | | |
| 60"W x 42"D | HTLC4260HCTPR | 207 | 16.2 | \$1432 | \$1454 |
| 72"W x 42"D | HTLC4272HCTPR | 216 | 16.9 | \$1669 | \$1699 |
| 96"W x 42"D | HTLC4296HCTPR | 274 | 41.6 | \$2013 | \$2056 |
| Standing-Height, Partial Modesty — Full Left Leg | | | | | |
| 60"W x 42"D | HTLC4260HCTPL | 207 | 16.2 | \$1432 | \$1454 |
| 72"W x 42"D | HTLC4272HCTPL | 216 | 16.9 | \$1669 | \$1699 |
| 96"W x 42"D | HTLC4296HCTPL | 274 | 41.6 | \$2013 | \$2056 |

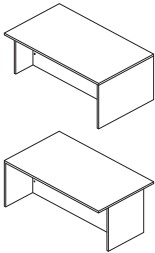

| | | | | | |
|---|----------------|-----|------|--------|--------|
| Seated-Height, Full Modesty — Full Right Leg | | | | | |
| 60"W x 42"D | HTLC4260LCTFPR | 180 | 14.2 | \$1254 | \$1276 |
| 72"W x 42"D | HTLC4272LCTFPR | 188 | 14.2 | \$1491 | \$1521 |
| 96"W x 42"D | HTLC4296LCTFPR | 247 | 39.3 | \$1835 | \$1878 |
| Seated-Height, Full Modesty — Full Left Leg | | | | | |
| 60"W x 42"D | HTLC4260LCTFPL | 180 | 14.2 | \$1254 | \$1276 |
| 72"W x 42"D | HTLC4272LCTFPL | 188 | 14.2 | \$1491 | \$1521 |
| 96"W x 42"D | HTLC4296LCTFPL | 247 | 39.3 | \$1835 | \$1878 |
| Standing-Height, Full Modesty — Full Right Leg | | | | | |
| 60"W x 42"D | HTLC4260HCTFPR | 223 | 18.0 | \$1432 | \$1454 |
| 72"W x 42"D | HTLC4272HCTFPR | 234 | 18.9 | \$1669 | \$1699 |
| 96"W x 42"D | HTLC4296HCTFPR | 299 | 44.7 | \$2013 | \$2056 |
| Standing-Height, Full Modesty — Full Left Leg | | | | | |
| 60"W x 42"D | HTLC4260HCTFPL | 223 | 18.0 | \$1432 | \$1454 |
| 72"W x 42"D | HTLC4272HCTFPL | 234 | 18.9 | \$1669 | \$1699 |
| 96"W x 42"D | HTLC4296HCTFPL | 299 | 44.7 | \$2013 | \$2056 |

NOTES:

- Maximum of 2 ganging tables can be used together. However, different widths may be combined to optimize your space (i.e., 60"W left-hand and 96"W right-hand can be combined).
- Ganging tables ship with all required hardware and light gap filler strip for use between the two partial legs.
- Tops feature 2mm flat edge.

⚠ Tables with partial and full modesty panels always feature cutout in modesty panel to accommodate grommet inserts in the top. However, top cutout is optional. Wire management is not included in legs.

HOW TO SPECIFY

| | | | | | |
|------------------------------------|--|--|---|---|--|
| <p>Select Model Number</p> | <p>Select Grommet Cutout</p> <p>N No Grommet G1 G1 Grommet (centered, + \$40 upcharge) G2 G2 Grommet (centered, + \$50 upcharge)</p> | <p>Select Top Laminate Color</p> <p>See page 82, Laminate Group A</p> | <p>Select Base Laminate Color</p> <p>See page 82, Laminate Group B</p> | <p>Select Modesty Laminate Color</p> <p>See page 82, Laminate Group B <i>Do not specify for Power Management models</i></p> | <p>Select 2mm Edge Color</p> <p>See page 83</p> |
| <p>H T L C 4 2 6 0 L C T P R .</p> | <p>G 1 .</p> | <p>L S A 1 .</p> | <p>H .</p> | <p>L S A 1 .</p> | <p>H</p> |



Icon Legend on page 17

PRESIDE® Collaborative Tables

| | DESCRIPTION | MODEL | SHIP WEIGHT | CUBE | LIST PRICE BY LAMINATE GRADE | |
|---|---|----------------------|-------------|------|------------------------------|---------------|
| | | | | | L1 | L2 |
| | Seated-Height, Collaborative Table with Partial Modesty Panel | | | | | |
| | 60"W x 30"D | HTLC3060LCTP | 136 | 11.1 | \$1055 | \$1074 |
| | 72"W x 30"D | HTLC3072LCTP | 150 | 12.6 | \$1274 | \$1300 |
| | 96"W x 30"D | HTLC3096LCTP | 184 | 15.7 | \$1583 | \$1620 |
| | Standing-Height, Collaborative Table with Partial Modesty Panel | | | | | |
| | 60"W x 30"D | HTLC3060HCTP | 174 | 13.1 | \$1207 | \$1226 |
| | 72"W x 30"D | HTLC3072HCTP | 192 | 14.8 | \$1426 | \$1452 |
| | 96"W x 30"D | HTLC3096HCTP | 232 | 18.0 | \$1735 | \$1772 |
| | Seated-Height, Collaborative Table with Full Modesty Panel | | | | | |
| | 60"W x 30"D | HTLC3060LCTFP | 151 | 11.5 | \$1055 | \$1074 |
| | 72"W x 30"D | HTLC3072LCTFP | 168 | 13.1 | \$1274 | \$1300 |
| | 96"W x 30"D | HTLC3096LCTFP | 208 | 16.1 | \$1583 | \$1620 |
| | Standing-Height, Collaborative Table with Full Modesty Panel | | | | | |
| | 60"W x 30"D | HTLC3060HCTFP | 190 | 14.8 | \$1207 | \$1226 |
| | 72"W x 30"D | HTLC3072HCTFP | 210 | 16.9 | \$1426 | \$1452 |
| | 96"W x 30"D | HTLC3096HCTFP | 256 | 21.1 | \$1735 | \$1772 |
| | Seated-Height, Collaborative Table with Power Management, No Modesty Panel | | | | | |
| | 60"W x 30"D | HTLC3060LCTHP | 133 | 8.3 | \$1312 | \$1331 |
| | 72"W x 30"D | HTLC3072LCTHP | 135 | 9.1 | \$1529 | \$1555 |
| | 96"W x 30"D | HTLC3096LCTHP | 164 | 11.3 | \$1837 | \$1874 |
| NOTES: Wire management available underneath top and through the base. Bases include a removable door to access cords at any time. | | | | | | |
| | Standing-Height, Collaborative Table with Power Management, No Modesty Panel | | | | | |
| | 60"W x 30"D | HTLC3060HCTHP | 156 | 9.8 | \$1616 | \$1653 |
| | 72"W x 30"D | HTLC3072HCTHP | 158 | 10.5 | \$1833 | \$1859 |
| | 96"W x 30"D | HTLC3096HCTHP | 187 | 12.8 | \$2141 | \$2178 |
| NOTES: Wire management available underneath top and through the base. Bases include a removable door to access cords at any time. | | | | | | |

NOTES:

- Tops feature 2mm flat edge.
- ! Tables with partial and full modesty panels always feature cutout in modesty panel to accommodate grommet inserts in the top. However, top cutout is optional. Wire management is not included in legs.
- ! Collaborative Tables with power management will not have modesty panels.

HOW TO SPECIFY

| | | | | | |
|---|---|---|--|---|---|
| <p>Select Model Number</p> <p>HTLC3060LCTP .</p> | <p>Select Cutout Option</p> <p>N No Cutout G1 Cutout for Pop-up Port (\$40 upcharge) G2 Cutout for Flip-top Port (\$50 upcharge)</p> <p>N .</p> | <p>Select Top Laminate Color</p> <p>See page 82, Laminate Group A</p> <p>H .</p> | <p>Select Base Laminate Color</p> <p>See page 82, Laminate Group B</p> <p>H .</p> | <p>Select Modesty Laminate Color</p> <p>See page 82, Laminate Group B</p> <p><i>Do not specify for Power Management models</i></p> <p>LDW1 .</p> | <p>Select 2mm Edge Color</p> <p>See page 83</p> <p>H</p> |
|---|---|---|--|---|---|

PRESIDE® Ganging Tables

OPEN MARKET



Icon Legend on page 17

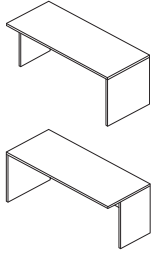

| DESCRIPTION | MODEL | SHIP WEIGHT | CUBE | LIST PRICE BY LAMINATE GRADE | |
|--|---------------|-------------|------|------------------------------|--------|
| | | | | L1 | L2 |
| Seated-Height, Partial Modesty — Full Right Leg | | | | | |
| 60"W x 30"D | HTLC3060LCTPR | 128 | 11.1 | \$1055 | \$1074 |
| 72"W x 30"D | HTLC3072LCTPR | 175 | 12.6 | \$1274 | \$1300 |
| 96"W x 30"D | HTLC3096LCTPR | 286 | 15.7 | \$1583 | \$1620 |
| Seated-Height, Partial Modesty — Full Left Leg | | | | | |
| 60"W x 30"D | HTLC3060LCTPL | 128 | 11.1 | \$1055 | \$1074 |
| 72"W x 30"D | HTLC3072LCTPL | 175 | 12.6 | \$1274 | \$1300 |
| 96"W x 30"D | HTLC3096LCTPL | 286 | 15.7 | \$1583 | \$1620 |
| Standing-Height, Partial Modesty — Full Right Leg | | | | | |
| 60"W x 30"D | HTLC3060HCTPR | 163 | 13.1 | \$1207 | \$1226 |
| 72"W x 30"D | HTLC3072HCTPR | 180 | 14.8 | \$1426 | \$1452 |
| 96"W x 30"D | HTLC3096HCTPR | 220 | 18.0 | \$1735 | \$1772 |
| Standing-Height, Partial Modesty — Full Left Leg | | | | | |
| 60"W x 30"D | HTLC3060HCTPL | 163 | 13.1 | \$1207 | \$1226 |
| 72"W x 30"D | HTLC3072HCTPL | 180 | 14.8 | \$1426 | \$1452 |
| 96"W x 30"D | HTLC3096HCTPL | 220 | 18.0 | \$1735 | \$1772 |

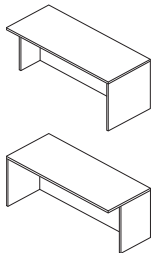

| | | | | | |
|---|----------------|-----|------|--------|--------|
| Seated-Height, Full Modesty — Full Right Leg | | | | | |
| 60"W x 30"D | HTLC3060LCTFPR | 143 | 11.5 | \$1055 | \$1074 |
| 72"W x 30"D | HTLC3072LCTFPR | 160 | 13.1 | \$1274 | \$1300 |
| 96"W x 30"D | HTLC3096LCTFPR | 200 | 16.1 | \$1583 | \$1620 |
| Seated-Height, Full Modesty — Full Left Leg | | | | | |
| 60"W x 30"D | HTLC3060LCTFPL | 143 | 11.5 | \$1055 | \$1074 |
| 72"W x 30"D | HTLC3072LCTFPL | 160 | 13.1 | \$1274 | \$1300 |
| 96"W x 30"D | HTLC3096LCTFPL | 200 | 16.1 | \$1583 | \$1620 |
| Standing-Height, Full Modesty — Full Right Leg | | | | | |
| 60"W x 30"D | HTLC3060HCTFPR | 178 | 14.8 | \$1207 | \$1226 |
| 72"W x 30"D | HTLC3072HCTFPR | 199 | 16.9 | \$1426 | \$1452 |
| 96"W x 30"D | HTLC3096HCTFPR | 245 | 21.1 | \$1735 | \$1772 |
| Standing-Height, Full Modesty — Full Left Leg | | | | | |
| 60"W x 30"D | HTLC3060HCTFPL | 178 | 14.8 | \$1207 | \$1226 |
| 72"W x 30"D | HTLC3072HCTFPL | 199 | 16.9 | \$1426 | \$1452 |
| 96"W x 30"D | HTLC3096HCTFPL | 245 | 21.1 | \$1735 | \$1772 |

NOTES:

- Maximum of 2 ganging tables can be used together. However, different widths may be combined to optimize your space (i.e., 60"W left-hand and 96"W right-hand can be combined).
- Ganging tables ship with all required hardware and light gap filler strip for use between the two partial legs.
- Tops feature 2mm flat edge.
- ⚠ Tables with partial and full modesty panels always feature cutout in modesty panel to accommodate grommet inserts in the top. However, top cutout is optional. Wire management is not included in legs.
- ⚠ Collaborative Tables with power management will not have modesty panels.

HOW TO SPECIFY

| | | | | | |
|--|---|--|--|--|---|
| <p>Select Model Number</p> <p>HTLC3060LCTPR</p> | <p>Select Grommet Cutout</p> <p>N No Grommet G1 G1 Grommet (centered, + \$40 upcharge) G2 G2 Grommet (centered, + \$50 upcharge)</p> <p>G1</p> | <p>Select Top Laminate Color</p> <p>See page 82, Laminate Group A</p> <p>LSA1</p> | <p>Select Base Laminate Color</p> <p>See page 82, Laminate Group B</p> <p>H</p> | <p>Select Modesty Laminate Color</p> <p>See page 82, Laminate Group B</p> <p>LSA1</p> | <p>Select 2mm Edge Color</p> <p>See page 83</p> <p>H</p> |
|--|---|--|--|--|---|

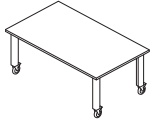

| DESCRIPTION | MODEL | SHIP WEIGHT | CUBE | LIST PRICE BY LAMINATE GRADE | |
|---|-------------------|-------------|------|------------------------------|---------------|
| | | | | L1 | L2 |
| Mobile Collaborative Tables | | | | | |
| 42" x 96" Seated | HTMC304296 | 205 | 16.5 | \$2339 | \$2382 |
| 42" x 72" Seated | HTMC304272 | 167 | 13.4 | \$2050 | \$2087 |
| 42" x 60" Seated | HTMC304260 | 147 | 12.1 | \$1783 | \$1811 |
| Mobile Collaborative Tables with Butcher Block Top | | | | | |
| 42" x 96" Standing | HTMC424296 | 219 | 17.8 | \$2417 | \$2460 |
| 42" x 72" Standing | HTMC424272 | 181 | 14.6 | \$2128 | \$2165 |
| 42" x 60" Standing | HTMC424260 | 161 | 13.3 | \$1861 | \$1889 |

| DESCRIPTION | MODEL | SHIP WEIGHT | CUBE | BUTCHER BLOCK |
|--------------------|---------------------|-------------|------|---------------|
| | | | | |
| 42" x 96" Seated | HTMC304296BB | 206 | 9.6 | \$3507 |
| 42" x 72" Seated | HTMC304272BB | 191 | 7.6 | \$3006 |
| 42" x 60" Seated | HTMC304260BB | 167 | 7.1 | \$2637 |
| 42" x 96" Standing | HTMC424296BB | 220 | 10.9 | \$3585 |
| 42" x 72" Standing | HTMC424272BB | 205 | 8.9 | \$3084 |
| 42" x 60" Standing | HTMC424260BB | 181 | 8.5 | \$2715 |

NOTES:

- Mobile collaborative tables standard with 4 locking 5" casters.
- Laminate tops feature 2mm flat edge.
- Butcher block top is 1½" thick and features 1½" radius corners.
- Butcher block tops will naturally feature variation between tops due to the nature of the real wood finish. Constructed of natural Birch wood, no two tops are exactly alike. Top is coated in a clear polyurethane finish for maximum durability.

HOW TO SPECIFY

| | | | | | |
|----------------------------|--|---|---|---------------------------------------|--|
| Select Model Number | Select Grommet Cutout N No Grommet | Select Top Laminate Color See page 82, Laminate Group A | Select Edge Color See page 83 | Select Caster C With Caster | Select Paint Color See page 82 |
| HTMC304296 | N | LSA1 | LSA1 | C | T1 |

| | | | | |
|----------------------------|--|---|---------------------------------------|--|
| Select Model Number | Select Grommet Cutout N No Grommet | Select Wood LH903 Butcher Block | Select Caster C With Caster | Select Paint Color See page 82 |
| HTMC304296BB | N | LH903 | C | T1 |

PRESIDE® Team Touchdown Tables

OPEN MARKET



Icon Legend on page 17

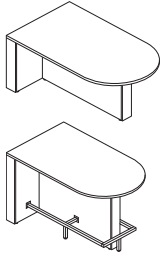

| DESCRIPTION | MODEL | SHIP WEIGHT | CUBE | LIST PRICE BY LAMINATE GRADE | |
|--|---------------------|-------------|------|------------------------------|---------------|
| | | | | L1 | L2 |
| Team Touchdown Tables | | | | | |
| 42" x 72" Seated Table | HTLMT4272L | 202 | 12.5 | \$1416 | \$1451 |
| 42" x 60" Seated Table | HTLMT4260L | 170 | 10.0 | \$1168 | \$1196 |
| 42" x 72" Standing Table | HTLMT4272H | 246 | 14.2 | \$1740 | \$1775 |
| 42" x 60" Standing Table | HTLMT4260H | 208 | 11.4 | \$1442 | \$1470 |
| 42" x 72" Standing Table w/ Footring | HTLMT4272HFR | 272 | 24.5 | \$2850 | \$2885 |
| 42" x 60" Standing Table w/ Footring | HTLMT4260HFR | 231 | 19.6 | \$2371 | \$2399 |
| Back Panel for Seated Team Touchdown Table | HTLMTLBACK | 23 | 3.2 | \$321 | \$336 |
| Back Panel for Standing Team Touchdown Table | HTLMTBACK | 33 | 4.5 | \$363 | \$380 |

NOTES: Specify Laminate, see page 82, Laminate Group B.
SPECIFYING EXAMPLE: HTLMTLBACK.LSA1

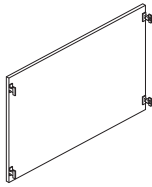

NOTES:

- Team Touchdown Tables feature open back standard. If closed back is desired, back panels must be specified separately.
- Back panel provides clearance for TV mount.
- Tops feature 2mm flat edge.

HOW TO SPECIFY

| | | | | | |
|---|--|--|--|--|--|
| <p>Select Model Number</p> <p>HTLMT4272L</p> | <p>Select Grommet Cutout</p> <p>N No Grommet G1 G1 Grommet (centered, + \$40 upcharge) G2 G2 Grommet (centered, + \$50 upcharge)</p> <p>G1</p> | <p>Select Top Laminate Color</p> <p>See page 82, Laminate Group A</p> <p>LSA1</p> | <p>Select Edge Color</p> <p>See page 83</p> <p>LSA1</p> | <p>Select Chassis Laminate</p> <p>See page 82, Laminate Group B</p> <p>LSA1</p> | <p>Select Paint Color</p> <p><i>Footring only available on FR models in P6P only</i></p> <p>P6P</p> |
|---|--|--|--|--|--|

| DESCRIPTION | MODEL | SHIP WEIGHT | CUBE | LIST PRICE BY PAINT GRADE | |
|-----------------|----------------|-------------|------|---------------------------|--------------|
| | | | | P1 | P2 |
| TV Mount | HTLMTTV | 4 | 1.0 | \$324 | \$354 |

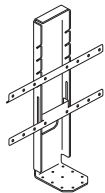

NOTES:

- TV mount is used to mount a television to the flat end of a Team Touchdown Table.
- Mounting hardware provided for television sizes 32" to 50" with VESA mounts of 100x100 to 200x200; for some televisions, additional hardware will be required (not provided).

HOW TO SPECIFY

| | |
|--|---|
| <p>Select Model Number</p> <p>HTLMTTV</p> | <p>Select Paint Color</p> <p>P Black</p> <p>P</p> |
|--|---|

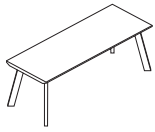

| DESCRIPTION | MODEL | SHIP WEIGHT | CUBE | LIST PRICE BY PAINT GRADE | | L2 UPCHARGE |
|----------------|-------------------|-------------|------|---------------------------|--------|-------------|
| | | | | P1 | P2 | |
| Benches | | | | | | |
| 18"D x 60"W | HTLBENCH60 | 23 | 2.3 | \$1593 | \$1693 | \$24 |
| 18"D x 48"W | HTLBENCH48 | 21 | 1.8 | \$1295 | \$1375 | \$20 |
| 18"D x 30"W | HTLBENCH30 | 18 | 1.8 | \$945 | \$1003 | \$15 |

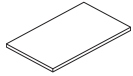

| DESCRIPTION | MODEL | SHIP WEIGHT | CUBE | LIST PRICE BY FABRIC GRADE | | | | | |
|----------------------|-----------------------|-------------|------|----------------------------|-------|-------|-------|-------|-------|
| | | | | 1 | 2 | 3 | 4 | 5 | 6 |
| Bench Cushion | | | | | | | | | |
| 18"D x 60"W | HTLBENCHCUSH60 | 16 | 3.6 | \$362 | \$406 | \$479 | \$499 | \$556 | \$616 |
| 18"D x 48"W | HTLBENCHCUSH48 | 12 | 2.9 | \$322 | \$361 | \$427 | \$445 | \$495 | \$549 |
| 18"D x 30"W | HTLBENCHCUSH30 | 8 | 1.9 | \$274 | \$307 | \$363 | \$378 | \$421 | \$466 |

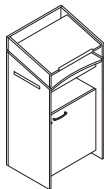

| DESCRIPTION | MODEL | SHIP WEIGHT | CUBE | LIST PRICE BY LAMINATE GRADE | |
|-------------------------|-----------------|-------------|------|------------------------------|--------|
| | | | | L1 | L2 |
| Laminate Lectern | HTLLECTA | 132 | 15.6 | \$1623 | \$1688 |

- Overall cabinet dimensions 24"W x 18"D x 50"H.
- Adjustable top worksurface features 3 tilt positions.
- Top of lectern can be removed and used on table top.
- Laptop shelf slides left or right.
- Includes 2 locking and 2 non-locking casters.
- Includes adjustable shelf in storage compartment.
- Features scallops in rear of lectern to route and conceal cables and wires.
- Metal components standard in black finish.

NOTES:

- Bench features knife edge along two long sides of seat; depth edges of top features flat edge allowing benches to be placed side by side without gaps.
- Bench cushions attach to bench seat with hook and loop.
- Fabric for bench cushions is upholstered in the railroad direction.

HOW TO SPECIFY

| | | | |
|---|--|--|--|
| <p>Select Model Number</p> <p>HTLBENCH48</p> | <p>Select Top Laminate Color</p> <p>See page 82, Laminate Group A</p> <p>LSA1</p> | <p>Select Edge Color</p> <p>See page 83</p> <p>SA</p> | <p>Select Paint Color</p> <p>See page 82, Paint Group A</p> <p>T1</p> |
| <p>Select Model Number</p> <p>HTLBENCHCUSH48</p> | <p>Select Fabric</p> <p>See page 82</p> <p>PBLE09</p> | | |
| <p>Select Model Number</p> <p>HTLLECTA</p> | <p>Select Laminate</p> <p>See page 82, Laminate Group B</p> <p>H</p> | <p>Select Pull</p> <p>J Loop Satin Nickel G Loop Black</p> <p>G</p> | |

PRESIDE® Laminate Storage

GSA SIN AS NOTED



Icon Legend on page 17

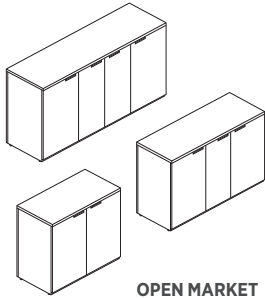

OPEN MARKET

DESCRIPTION

Hospitality Credenza
20\"/>

| MODEL | SHIP WEIGHT | CUBE | LIST PRICE BY LAMINATE GRADE | |
|------------------|-------------|------|------------------------------|---------------|
| | | | L1 | L2 |
| HTLCRED72 | 301 | 40.0 | \$3023 | \$3073 |
| HTLCRED57 | 250 | 31.8 | \$2622 | \$2662 |
| HTLCRED42 | 200 | 23.7 | \$2087 | \$2184 |

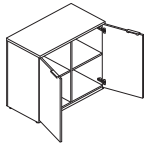

OPEN MARKET

Hospitality Credenza with Shelves

20\"/>

| | | | | |
|-------------------|-----|------|---------------|---------------|
| HTLCRED72S | 311 | 41.5 | \$3175 | \$3225 |
| HTLCRED57S | 260 | 33.3 | \$2774 | \$2814 |
| HTLCRED42S | 210 | 25.2 | \$2239 | \$2336 |

NOTES: Hospitality credenzas with shelves ship with 2 shelves in separate cartons. Additional shelves can be ordered separately if desired.

HOW TO SPECIFY

| Select Model Number | Select Top Laminate Color | Select 2mm Edge Color | Select Chassis Laminate | Select Pull | Select Back Cutout | Select Shelf Laminate |
|-------------------------------|-------------------------------|-----------------------|-------------------------------|---|---|---|
| See page 82, Laminate Group A | See page 82, Laminate Group B | See page 83 | See page 82, Laminate Group B | J Loop Satin Nickel G Loop Black 3 Rounded Square Matte Chrome 4 Rounded Square Black VP HLSL Voi® Pull Black VPJW HLSL Voi® Pull Designer White VT4 HLSL Voi® Pull Champagne Metallic VT1 HLSL Voi® Pull Platinum Metallic VPR6 HLSL Voi® Pull Silver VP8X HLSL Voi® Pull Solar Black | C Vent Cutout (+ \$50) N No Cutout | See page 82, Laminate Group B <i>Specify for shelf models only</i> |
| HTLCRED57S | LSA1 | SA | LSA1 | J | C | T1 |

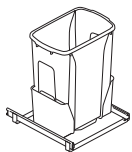

OPEN MARKET

DESCRIPTION

Trash Bin Slide
 • Holds a 35 quart bin.
 • Trash bin is included with model.
 • Can be used in outer compartments of credenza models above.

| MODEL | SHIP WEIGHT | CUBE | L1 LIST PRICE | L2 UPCHARGE |
|-------------------|-------------|------|---------------|-------------|
| HTBINSLIDE | 15 | 3.5 | \$226 | N/A |

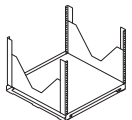

SIN 33721

Mounted AV Rack

• Can be used in outer compartments of credenza models above.

| | | | | |
|---------------|----|-----|---------------|------------|
| HTRACK | 15 | 4.8 | \$2049 | N/A |
|---------------|----|-----|---------------|------------|



SIN 33721

Laminate Credenza Shelf

• Shelf can be utilized in the outer compartments of the credenza.
 • 3 mounting locations within outer compartment on the credenza.
 • Mounting locations are 6\"/>

| | | | | |
|-----------------|----|-----|-------------|-------------|
| HTLSHELF | 10 | 1.5 | \$76 | \$10 |
|-----------------|----|-----|-------------|-------------|

HOW TO SPECIFY

| Select Model Number | Select Laminate |
|-------------------------------|-----------------|
| See page 82, Laminate Group B | |
| HTLSHELF | H |



Icon Legend on page 17

PRESIDE® Laminate Storage

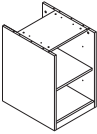
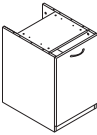
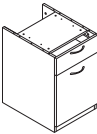
| | DESCRIPTION | MODEL | SHIP WEIGHT | CUBE | LIST PRICE BY LAMINATE GRADE | |
|---|--|-------------|-------------|------|------------------------------|-------|
| | | | | | L1 | L2 |
|  <i>Model HTLMC1828O shown</i> | Modular Pedestal, Bookshelf, No Door | HTLMC1828O | 70 | 9.8 | \$592 | \$617 |
|  <i>Model HTLMC1828L shown</i> | Modular Pedestal, Bookshelf, with Door (left) | HTLMC1828L | 70 | 9.8 | \$723 | \$753 |
| | Modular Pedestal, Bookshelf, with Door (right) | HTLMC1828R | 70 | 9.8 | \$723 | \$753 |
|  <i>Model HTLMC1828DR shown</i> | Modular Pedestal, Box Drawer, Cabinet Door (left) | HTLMC1828DL | 70 | 9.8 | \$769 | \$799 |
| | Modular Pedestal, Box Drawer, Cabinet Door (right) | HTLMC1828DR | 70 | 9.8 | \$769 | \$799 |

NOTES:

- Use Concinnity™ laminate tops and backs with Preside® modular storage for a finished look. See page 112.

HOW TO SPECIFY

| | | |
|---|--|---|
| <p>Select Model Number</p> <p>HTLMC1828L</p> | <p>Select Pull Option</p> <p>J Loop Satin Handle G Loop Black 3 Rounded Square Matte Chrome 4 Rounded Square Black X No Pull (for model HTLMC1828O only)</p> <p>J</p> | <p>Select Laminate</p> <p>See page 82, Laminate Group B</p> <p>N</p> |
|---|--|---|

MODULAR COMPONENTS

OPEN MARKET



Icon Legend on page 17

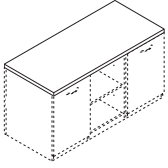

| DESCRIPTION | MODEL | SHIP WEIGHT | CUBE | LIST PRICE BY LAMINATE GRADE | |
|--|------------------|-------------|------|------------------------------|--------------|
| | | | | L1 | L2 |
| Concinnity™ Rectangle Worksurface with Horizontal Grain | | | | | |
| 90"W x 24"D | HNLRC2490 | 75 | 5.5 | \$572 | \$602 |
| 72"W x 24"D | HNLRC2472 | 60 | 4.6 | \$402 | \$422 |
| 54"W x 24"D | HNLRC2454 | 45 | 3.5 | \$328 | \$348 |
| 36"W x 24"D Rectangle Worksurface/Pedestal Top | HNLRC2436 | 30 | 2.4 | \$253 | \$268 |

NOTES: Use Concinnity™ laminate tops and backs with Preside® modular storage for a finished look.

- ! Grain direction on all rectangle worksurfaces runs horizontal (side-to-side) except as follows: 30"W - 36"W - 42"W - 48"W - 54"W - 60"W x 24"D tops can be specified with horizontal (side-to-side) or vertical (front-to-back) grain.
- ! 42"W and 48"W x 20"D tops are available with vertical (front-to-back) grain only.

HOW TO SPECIFY

| | | | |
|--|--|--|--|
| <p>Select Model Number</p> <p>H N L R C 2 4 9 0 .</p> | <p>Select Edge Profile and Edge Color</p> <p>See page 29 in the 2021 Workspaces Pricer</p> <p>B H .</p> | <p>Select Worksurface Grommet Finish</p> <p>P Black T1 Platinum X No Grommet</p> <p>P .</p> | <p>Select Worksurface Color</p> <p>See page 29 in the 2021 Workspaces Pricer</p> <p>H</p> |
|--|--|--|--|

MODULAR COMPONENTS

Back Panels

OPEN MARKET



Icon Legend on page 17

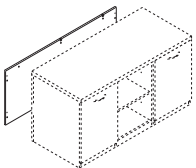

| DESCRIPTION | MODEL | SHIP WEIGHT | CUBE | LIST PRICE BY LAMINATE GRADE | |
|--|------------------|-------------|------|------------------------------|--------------|
| | | | | L1 | L2 |
| Concinnity™ Modesty/Back Panels — Full-Length | | | | | |
| 90"W x 27 ⁷ / ₈ "H | HNLMP9028 | 58 | 6.7 | \$459 | \$484 |
| 72"W x 27 ⁷ / ₈ "H | HNLMP7228 | 46 | 5.3 | \$314 | \$334 |
| 54"W x 27 ⁷ / ₈ "H | HNLMP5428 | 34 | 4.0 | \$258 | \$278 |
| 36"W x 27 ⁷ / ₈ "H Modesty/Pedestal Back Panel | HNLMP3628 | 22 | 2.8 | \$208 | \$220 |

NOTES: Component is 3/4" thick. Provide approach-side kneespace privacy for user seated at desks, credenzas, returns, and bridges.

HOW TO SPECIFY

| | | |
|--|---|---|
| <p>Select Model Number</p> <p>H N L M P 7 2 2 8 .</p> | <p>Select Grommet</p> <p>P Black X No Grommet</p> <p>X .</p> | <p>Select Laminate Color</p> <p>See page 29 in the 2021 Workspaces Pricer</p> <p>H</p> |
|--|---|---|



WALL MOUNT STORAGE

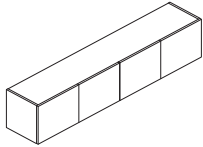

DESCRIPTION

Concinnity™ Wall Mount Storage, Laminate Doors

- 78"W x 15"D x 15"H — 4 doors, 2 compartments
- 72"W x 15"D x 15"H — 4 doors, 2 compartments
- 66"W x 15"D x 15"H — 4 doors, 2 compartments
- 60"W x 15"D x 15"H — 4 doors, 2 compartments
- 48"W x 15"D x 15"H — 3 doors, 2 compartments
- 42"W x 15"D x 15"H — 2 doors, 1 compartment
- 36"W x 15"D x 15"H — 2 doors, 1 compartment
- 30"W x 15"D x 15"H — 2 doors, 1 compartment

| MODEL | SHIP WEIGHT | CUBE | L1 LIST | L2 UPCHARGES | |
|------------------|-------------|------|---------------|--------------|-------------|
| | | | | CHASSIS | FRONTS |
| HNL1578LD | 126 | 17.1 | \$1362 | \$35 | \$20 |
| HNL1572LD | 118 | 15.9 | \$1265 | \$25 | \$20 |
| HNL1566LD | 109 | 14.6 | \$1206 | \$25 | \$20 |
| HNL1560LD | 100 | 13.3 | \$1083 | \$25 | \$20 |
| HNL1548LD | 83 | 10.9 | \$977 | \$20 | \$20 |
| HNL1542LD | 68 | 9.7 | \$923 | \$20 | \$10 |
| HNL1536LD | 60 | 8.4 | \$842 | \$20 | \$10 |
| HNL1530LD | 51 | 7.2 | \$777 | \$20 | \$10 |

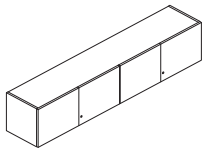

Concinnity™ Wall Mount Storage, Laminate Locking Doors

- 78"W x 15"D x 15"H — 4 doors, 2 compartments
- 72"W x 15"D x 15"H — 4 doors, 2 compartments
- 66"W x 15"D x 15"H — 4 doors, 2 compartments
- 60"W x 15"D x 15"H — 4 doors, 2 compartments
- 48"W x 15"D x 15"H — 3 doors, 2 compartments
- 42"W x 15"D x 15"H — 2 doors, 1 compartment
- 36"W x 15"D x 15"H — 2 doors, 1 compartment
- 30"W x 15"D x 15"H — 2 doors, 1 compartment

| | | | | | |
|------------------|-----|------|---------------|-------------|-------------|
| HNL1578LL | 126 | 17.1 | \$1451 | \$35 | \$20 |
| HNL1572LL | 118 | 15.9 | \$1354 | \$25 | \$20 |
| HNL1566LL | 109 | 14.6 | \$1295 | \$25 | \$20 |
| HNL1560LL | 100 | 13.3 | \$1172 | \$25 | \$20 |
| HNL1548LL | 83 | 10.9 | \$1044 | \$20 | \$20 |
| HNL1542LL | 68 | 9.7 | \$967 | \$20 | \$10 |
| HNL1536LL | 60 | 8.4 | \$887 | \$20 | \$10 |
| HNL1530LL | 51 | 7.2 | \$822 | \$20 | \$10 |

! Lock available in Black (P) or Satin (SA) finish. Lock is core removable. Keyed alike cores must be ordered separately. For stack-on and wall mount storage with locking hinged doors, specify model HF27B (Black) or HF27S (Satin) and the key number, see the Desks section in the 2021 Workspaces Pricer. Model HNL1548LL has one lock, which secures two of the three doors.

NOTES:

- Preside® tables pair well with Concinnity™ Wall Mounted Storage to create a complete conference or collaborative layout.
- Convenient off-the-worksurface storage requires no additional floor space.
- Available with laminate doors, frosted/silver doors, or sliding door.
- Doors are sized to overlap the top, end panels and light valance, to provide a clean design.
- Laminate and frosted/silver door units are equipped with self-closing, adjustable hinges.
- Laminate hinged door units are available with or without a lock.
- For tackboards, see the Desks section in the 2021 Workspaces Pricer.
- For task lights, see the Desks section in the 2021 Workspaces Pricer.
- For paper organizers, see the Desks section in the 2021 Workspaces Pricer.
- **IMPORTANT: See installation guidelines in the Desks section in the 2021 Workspaces Pricer.**

HOW TO SPECIFY

| | | | |
|--|--|---|---|
| <p>Select Model Number</p> <p>H N L 1 5 7 8 L D</p> | <p>Select Chassis Color</p> <p>See page 29 in the 2021 Workspaces Pricer</p> <p>H</p> | <p>Select Door Front Color</p> <p>See page 29 in the 2021 Workspaces Pricer</p> <p>H</p> | |
| <p>Select Model Number</p> <p>H N L 1 5 7 8 L L</p> | <p>Select Lock Finish</p> <p>See page 29 in the 2021 Workspaces Pricer</p> <p>P</p> | <p>Select Chassis Color</p> <p>See page 29 in the 2021 Workspaces Pricer</p> <p>H</p> | <p>Select Door Front Color</p> <p>See page 29 in the 2021 Workspaces Pricer</p> <p>H</p> |

WALL MOUNT STORAGE

OPEN MARKET



Icon Legend on page 17

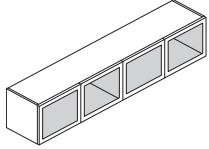

DESCRIPTION

Concinnity™ Wall Mount Storage, Frosted Doors with Silver Frame

- 78"W x 15"D x 15"H — 4 doors, 2 compartments
- 72"W x 15"D x 15"H — 4 doors, 2 compartments
- 66"W x 15"D x 15"H — 4 doors, 2 compartments
- 60"W x 15"D x 15"H — 4 doors, 2 compartments
- 48"W x 15"D x 15"H — 3 doors, 2 compartments
- 42"W x 15"D x 15"H — 2 doors, 1 compartment
- 36"W x 15"D x 15"H — 2 doors, 1 compartment
- 30"W x 15"D x 15"H — 2 doors, 1 compartment

| MODEL | SHIP WEIGHT | CUBE | L1 LIST | L2 UPCHARGES | |
|------------------|-------------|------|---------------|--------------|------------|
| | | | | CHASSIS | FRONTS |
| HNL1578FD | 106 | 17.1 | \$2060 | \$35 | N/A |
| HNL1572FD | 99 | 15.9 | \$1961 | \$25 | N/A |
| HNL1566FD | 92 | 14.6 | \$1901 | \$25 | N/A |
| HNL1560FD | 85 | 13.3 | \$1777 | \$25 | N/A |
| HNL1548FD | 71 | 10.9 | \$1498 | \$20 | N/A |
| HNL1542FD | 57 | 9.7 | \$1274 | \$20 | N/A |
| HNL1536FD | 50 | 8.4 | \$1193 | \$20 | N/A |
| HNL1530FD | 43 | 7.2 | \$1127 | \$20 | N/A |

❗ Frosted door models do not have a lock option.

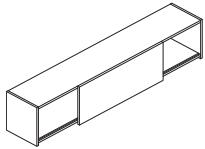

Concinnity™ Wall Mount Storage, Sliding Door

- 78"W x 15"D x 15"H
- 72"W x 15"D x 15"H
- 66"W x 15"D x 15"H
- 60"W x 15"D x 15"H
- 48"W x 15"D x 15"H

| | | | | | |
|------------------|-----|------|---------------|-------------|-------------|
| HNL1578SD | 114 | 17.1 | \$1325 | \$35 | \$20 |
| HNL1572SD | 107 | 15.9 | \$1217 | \$25 | \$20 |
| HNL1566SD | 99 | 14.6 | \$1135 | \$25 | \$20 |
| HNL1560SD | 91 | 13.3 | \$1031 | \$25 | \$20 |
| HNL1548SD | 76 | 10.9 | \$965 | \$20 | \$20 |

NOTES: One door per unit. Standard with black lock, which is located on the inside vertical support panel.

NOTES:

- Preside® tables pair well with Concinnity™ Wall Mounted Storage to create a complete conference or collaborative layout.
- Convenient off-the-worksurface storage requires no additional floor space.
- Available with laminate doors, frosted/silver doors, or sliding door.
- Doors are sized to overlap the top, end panels and light valance, to provide a clean design.
- Laminate and frosted/silver door units are equipped with self-closing, adjustable hinges.
- Laminate hinged door units are available with or without a lock.
- For tackboards, see the Desks section in the 2021 Workspaces Pricer.
- For task lights, see the Desks section in the 2021 Workspaces Pricer.
- For paper organizers, see the Desks section in the 2021 Workspaces Pricer.
- **IMPORTANT: See installation guidelines in the Desks section in the 2021 Workspaces Pricer.**

HOW TO SPECIFY

| | | |
|---|---|--|
| <p>Select Model Number</p> <div style="border: 1px solid black; display: flex; justify-content: space-between; padding: 2px;"> HNL1578FD </div> | <p>Select Chassis Color</p> <p>See page 29 in the 2021 Workspaces Pricer</p> <div style="border: 1px solid black; display: flex; justify-content: space-between; padding: 2px;"> H </div> | |
| <p>Select Model Number</p> <div style="border: 1px solid black; display: flex; justify-content: space-between; padding: 2px;"> HNL1578SD </div> | <p>Select Chassis Color</p> <p>See page 29 in the 2021 Workspaces Pricer</p> <div style="border: 1px solid black; display: flex; justify-content: space-between; padding: 2px;"> H </div> | <p>Select Door Front Color</p> <p>See page 29 in the 2021 Workspaces Pricer</p> <div style="border: 1px solid black; display: flex; justify-content: space-between; padding: 2px;"> H </div> |



Icon Legend on page 17

PRESIDE® Laminate Shared Components

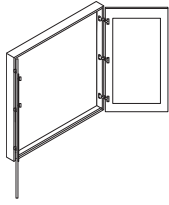

DESCRIPTION

Laminate Presentation Cabinet

- Overall cabinet dimensions 48⁷/₈"W x 5"D x 49¹/₂"H.
- Mounts to wall.
- Presentation cabinet features one magnetic white board, one tackboard and one paper pad.
- Self-adjusting hinges ensure doors are in alignment.

| MODEL | SHIP WEIGHT | CUBE | LIST PRICE BY LAMINATE GRADE | |
|---------|-------------|------|------------------------------|--------|
| | | | L1 | L2 |
| HTLPRES | 169 | 10.9 | \$1777 | \$1857 |

HOW TO SPECIFY

| | |
|----------------------------|-------------------------------|
| Select Model Number | Select Laminate |
| H T L P R E S . | See page 82, Laminate Group B |
| | D |

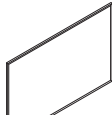
| DESCRIPTION | MODEL | SHIP WEIGHT | CUBE | LIST PRICE |
|---|-------------------|-------------|------|--------------|
|  <p>Markerboard</p> <ul style="list-style-type: none"> • Overall markerboard dimensions 48"W x 31"H. • Mounts on wall. Can be mounted horizontally or vertically. • Markerboard is magnetic. • No specification required. | HLSL4831MB | 44.0 | 3.4 | \$713 |

OPEN MARKET

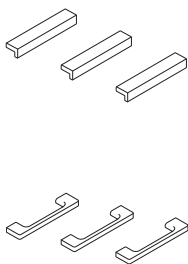

Field Installable Drawer/Door Handle Kits

| | | | | |
|------------------------------|------------------|-----|-----|--------------|
| Linear, Black, 1-pack | HLINEARA1 | 0.5 | 1.4 | \$37 |
| Linear, Matte Chrome, 1-pack | HLINEARC1 | 0.5 | 1.4 | \$37 |
| Linear, Black, 8-pack | HLINEARA8 | 0.5 | 1.4 | \$197 |
| Linear, Matte Chrome, 8-pack | HLINEARC8 | 0.5 | 1.4 | \$197 |
| Arch, Black, 1-pack | HARCHA1 | 0.5 | 1.4 | \$37 |
| Arch, Matte Chrome, 1-pack | HARCHC1 | 0.5 | 1.4 | \$37 |
| Arch, Black, 8-pack | HARCHA8 | 0.5 | 1.4 | \$197 |
| Arch, Matte Chrome, 8-pack | HARCHC8 | 0.5 | 1.4 | \$197 |

HOW TO SPECIFY

| | |
|----------------------------|--|
| Select Model Number | |
| H L I N E A R A 1 | |



Icon Legend on page 17

CABLE MANAGEMENT

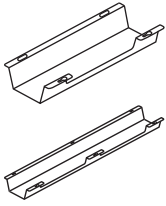
**DESCRIPTION****Cable Management Troughs**

17"W — Single

17"W — 10-Pack

36"W — Single

36"W — 10-Pack

- Cable management troughs ship flat packed.
- The troughs attach to underneath the worksurface with screws.
- Cutouts in trough allow access to power without the need to detach from surface. 17"W = 1 cutout; 36"W = 2 cutouts.
- Color: Graphite.
- Material: Metal.
- TAA Compliant.

MODEL**SHIP WEIGHT****CUBE****LIST PRICE****HCTROUGH17**

2.7

0.5

\$73**HCTROUGH1710**

14.0

0.5

\$665**HCTROUGH36**

4.9

0.9

\$122**HCTROUGH3610**

30.0

0.9

\$1121





HOW TO SPECIFY

Select
Model Number

HCTROUGH17

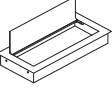
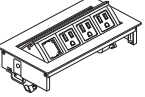
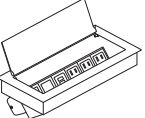

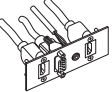
PRESIDE® Table Power Accessories

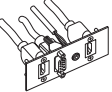
| | DESCRIPTION | MODEL | SHIP WEIGHT | CUBE | LIST PRICE |
|---|---|-------------------------|-------------|------|--------------|
|  | Blank G1 Cutout Insert | HGROM1BLANK | 2 | 0.2 | \$163 |
| | Blank G2 Cutout Insert | HGROM2BLANK | 2 | 0.2 | \$249 |
| ! Grommets available in BLK, FOG, and SVR only. | | | | | |
|  | MhoB 4" x 8" Pop-up Port | HTG1PWR-3P-1B | 5 | 0.3 | \$424 |
| | <ul style="list-style-type: none"> Specify G1 cutout in table top. Pop-up Port provides three power ports and one blank data receptacle. Sits flush with worksurface when closed. Includes 6' cord with three-prong plug. | | | | |
|  | ElloraB 5" x 11" Flip-top Port | HTG2PWR-4P-2B | 5 | 0.3 | \$626 |
| | <ul style="list-style-type: none"> Specify G2 cutout in table top. Flip-top Port provides four power ports and two blank data receptacles. Conceals wires and allows power cords to be plugged in while in use. Includes 10' cord with three-prong circuit breaker plug. <p>NOTES: Two circuit breaker plugs do not fit into one duplex.</p> | | | | |
|  | ElloraB 5" x 11" Flip-top Port | HTG2PWR-3P-1E | 5 | 0.3 | \$767 |
| | <ul style="list-style-type: none"> Specify G2 cutout in table top. Flip-top Port provides one blank for Extron plate and three power ports. Extron AAP plates can be integrated into grommet to support changing technology. Conceals wires and allows power cords to be plugged in while in use. Includes 10' cord with three-prong plug. | | | | |
|  | ElloraB 5" x 11" Flip-top Port | HTG2PWR-3P-2B-2U | 5 | 0.3 | \$909 |
| | <ul style="list-style-type: none"> Specify G2 cutout in table top. Flip-top Port provides 3 Power, 1 USB, and 2 Blank Data Ports. Conceals wires and allows power cords to be plugged in while in use. Includes 10' cord with three-prong plug. | | | | |
|  | ElloraB 5" x 11" Flip-top Port | HTG2PWR-3P-1U-W | 5 | 0.3 | \$930 |
| | <ul style="list-style-type: none"> Specify G2 cutout in table top. Flip-top Port provides 3 Power, 1 USB, and Qi wireless charging lid. Conceals wires and allows power cords to be plugged in while in use. Includes 10' cord with three-prong plug. | | | | |
|  | Extron Plate (Double Space) — VGA, HDMI, HDMI, Audio | HTPLATEVHAU | 1 | 0.1 | \$428 |
| | <p>NOTES: 1 Double Space plate can be used in a single HTG2PWR-3P-1E flip-top port.</p> <p>! Extron plates can be retrofitted to be used on HTG2PWR-3P-1E.</p> | | | | |

HOW TO SPECIFY

Select Model Number

HTG2PWR-4P-2B.

Select Paint Color

FOG Fog
SVR Silver
BLK Black

SVR

PRESIDE® Table Power Accessories

GSA SIN 33721



Icon Legend on page 17

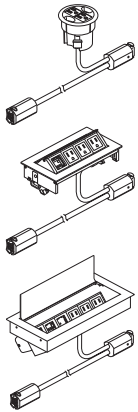

| DESCRIPTION | MODEL | SHIP WEIGHT | CUBE | LIST PRICE |
|---|---------------|-------------|------|------------|
| Interlink IQ Power Harness – 1’ Power Hub, 3” Round Grommet Mount • Available in Black finish, no specification needed. | HQH1-3 | 2.0 | 0.2 | \$186 |
| Interlink IQ Power Harness – 5’ Power Hub, 3” Round Grommet Mount • Available in Black finish, no specification needed. | HQH5-3 | 2.0 | 0.2 | \$208 |
| Interlink IQ Power Harness – 5’ with 4” x 8” Pop-Up Port (3 Power, 1 Blank) • For use with tables G1 grommet. Specify paint. | HQH5-P-3P1B | 3.0 | 0.3 | \$408 |
| Interlink IQ Power Harness – 5’ with 5” x 11” Flip-Top Port (3 Power, 3 Blank) • For use with Preside® G2 grommet. Specify paint. | HQH5-E-3P3B | 5.0 | 0.2 | \$429 |
| Interlink IQ Power Harness – 5’ with 5” x 11” Flip-Top Port (3 Power, 1 Extron Double Space) • For use with Preside® G2 grommet. Specify paint. | HQH5-E-3P1E | 5.0 | 0.2 | \$452 |
| Interlink IQ Power Harness – 5’ with 5” x 11” Flip-Top Port (3 Power, 2 USB, 2 Blank) • For use with Preside® G2 grommet. Specify paint. | HQH5-E-3P1U2B | 5.0 | 0.2 | \$473 |

Hardwire Power System:

The hardwire power system is only needed if 6’ power cables from power ports are not long enough to reach an outlet, or if there is a need to route power below entire length of worksurface from one power in-feed. By specifying one power kit for each top section, there will be two duplex receptacles below each top section. For technical details regarding 2-circuit power system, see page 63.

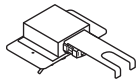

| | | | | |
|--|----------|-----|-----|-------|
| 4-Trac Power Entry Plate • Connects to wall to route power to table. | HMAPLATE | 1.0 | 0.2 | \$102 |
|--|----------|-----|-----|-------|

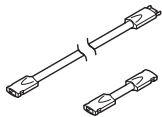

| | | | | |
|---|----------|-----|-----|-------|
| 4-Trac Power Entry Cable • 6’ power entry cable with male/female adapter. • Connects table to power entry plate. | HMACABLE | 1.8 | 0.2 | \$159 |
|---|----------|-----|-----|-------|

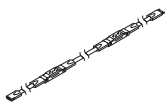

| | | | | |
|--|------------|-----|-----|-------|
| 4-Trac Circuit 1 Power Kit for 60”W Top Section | HMAPOWER60 | 2.0 | 0.3 | \$302 |
| 4-Trac Circuit 1 Power Kit for 72”W Top Section | HMAPOWER72 | 2.2 | 0.3 | \$309 |
| 4-Trac Circuit 1 Power Kit for 84”W Top Section | HMAPOWER84 | 2.4 | 0.3 | \$320 |
| 4-Trac Circuit 1 Power Kit for 96”W Top Section | HMAPOWER96 | 2.6 | 0.3 | \$331 |

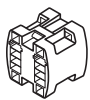

| | | | | |
|---|----------|-----|-----|------|
| Electrical Connectors 4-Way Splitter ! Available in Black (P) only. SPECIFYING EXAMPLE: HMASPLIT.P | HMASPLIT | 0.9 | 0.1 | \$55 |
|---|----------|-----|-----|------|

HOW TO SPECIFY

| | |
|---|--|
| Select Model Number HQH5-E-3P3B | Select Paint Color FOG Fog SVR Silver BLK Black SVR |
|---|--|

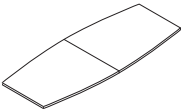
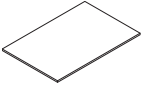
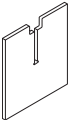

PRESIDE® Laminate Tables

| | DESCRIPTION | MODEL | SHIP WEIGHT | CUBE | LIST PRICE |
|---|---|-------------------|-------------|------|---------------|
|  | Laminate Boat Shaped Table Tops with Stretcher | | | | |
| | 168"W x 48"D | HTLB16848P | 319 | 11.9 | \$1564 |
| | 144"W x 48"D | HTLB14448P | 266 | 9.8 | \$1242 |
| | 120"W x 48"D | HTLB12048P | 217 | 8.2 | \$1126 |
|  | Laminate Adder Section with Stretcher 72"W x 48"D | HTLM7248P | 144 | 9.8 | \$826 |
|  | Laminate Bases | | | | |
| | Laminate Panel Bases, Double Pack | HTLPB | 53 | 3.1 | \$448 |
| | Laminate Panel Bases, Single Pack | HTLPBS | 28 | 3.1 | \$271 |

| | With Panel Base |
|--------------------------|---|
| HTLB12048P HTLB14448P | 1 x HTLPB (Laminate Panel Base) |
| HTLB16848P | 1 x HTLPB (Laminate Panel Base) 1 x HTLPBS (Laminate Panel Mid-Base) |
| HTLM7248P | 1 x HTLPBS (Laminate Panel Mid-Base) |

NOTES:

- Tops and Modesty Panels are 1/8" Melamine.
- 168"W Boat-Shaped Top needs 3 bases; 72"W Middle Adder needs 1 base. All other tops need 2 bases.
- 120", 144", and 168"W Tops ship in 2 pieces to facilitate handling and installation; these top sizes will not have an exact grain alignment where the two halves meet, a reasonable match can be expected.
- ! Tops with Stretcher and Adder Section with Stretcher available in Harvest (C) and Mahogany (N) finishes only.
- ! Tops available in Boat Shape with G edge (2mm self edge) only; Middle Adder is rectangular with G edge.
- ! Edge finish always matches top finish.

HOW TO SPECIFY

| | | |
|--|---|---|
| <p>Select Model Number</p> <p>HTLB16848P.</p> | <p>Select Grommet Option</p> <p>N No grommet (only option)</p> <p>N.</p> | <p>Select Laminate</p> <p>C Harvest N Mahogany</p> <p>C.</p> |
|--|---|---|

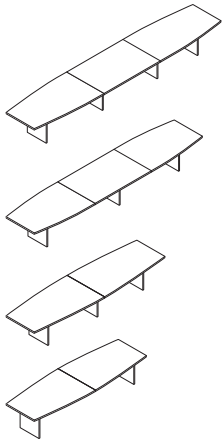

| DESCRIPTION | MODEL | SHIP WEIGHT | CUBE | LIST PRICE |
|---|-------------------|-------------|------|---------------|
| Boat Shape Laminate Tables with Panel Base | | | | |
| 240"W x 48"D | HTLB2048LP | 572 | 31.0 | \$3380 |
| 216"W x 48"D | HTLB1848LP | 491 | 25.9 | \$2787 |
| 192"W x 48"D | HTLB1648LP | 442 | 24.3 | \$2671 |
| 168"W x 48"D | HTLB1448LP | 400 | 18.1 | \$2283 |
| 144"W x 48"D | HTLB1248LP | 319 | 12.9 | \$1690 |
| 120"W x 48"D | HTLB1048LP | 270 | 11.3 | \$1574 |

NOTES: Order entire typical with one model number to get desired table size. Table top and bases are included.

NOTES:

- Tops and Modesty Panels are 1 1/8" Melamine.
- 168"W Boat-Shaped Top needs 3 bases; 72"W Middle Adder needs 1 base. All other tops need 2 bases.
- 120", 144", and 168"W Tops ship in 2 pieces to facilitate handling and installation; these top sizes will not have an exact grain alignment where the two halves meet, a reasonable match can be expected.
- ! Available in Harvest (C) and Mahogany (N) finishes only.
- ! Tops available in Boat Shape with G edge (2mm self edge) only; Middle Adder is rectangular with G edge.
- ! Edge finish always matches top finish.

HOW TO SPECIFY

| | | | |
|---|--|--|--|
| <p>Select Model Number</p> <p>HTLB2048LP</p> | <p>Select Grommet Option</p> <p>N No grommet (only option)</p> <p>N</p> | <p>Select Laminate</p> <p>C Harvest N Mahogany</p> <p>C</p> | <p>Select Edge Color</p> <p>C Harvest N Mahogany</p> <p>C</p> |
|---|--|--|--|

SCRAMBLE™ OCCASIONAL TABLES

Want to see more? Scan here
to check out hon.com.



Scramble™ Coffee Table shown with
West Hill™ Casual Lounge Seating.

SCRAMBLE™

For every tablet, coffee mug, or notepad there's a need for an occasional table. Don't scramble to find an open meeting room when you can move to where relaxed productivity happens whether it's a lounge, commons, or nook area. Designed to coordinate with any of HON's soft seating lines, Scramble occasional tables fit in any space you need to work comfortably.



FEATURES

- Select from Soft Rectangle, Soft Square, and Round top shapes.
- Multiple size ranges available from side to large coffee tables.
- Coordinate with any of HON's soft seating series to create a space that works.
- Angled hardwood legs with metal stretcher bars provide a mid-century feel.
- Assorted leg and stretcher bar finishes available to match any aesthetic.
- Match the style of any space, with laminate tops including both flat and knife edges, as well as premium back-painted glass tops.

SCRAMBLE™ Options

MODEL OPTIONS

HSCCSR2448LM
HSCCSR2448LMK
HSCCSR2448BPG

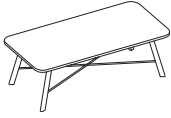

Coffee Table
Soft Rectangle

HSCCSS36LM, HSCCSS36LMK, HSCCSS36BPG
HSCCSS48LM, HSCCSS48LMK, HSCCSS48BPG



Coffee Table
Soft Square

HSCCR36LM, HSCCR36LMK, HSCCR36BPG
HSCCR48LM, HSCCSS48LMK, HSCCR48BPG



Coffee Table
Round

HSCSS24LM
HSCSS24LMK
HSCSS24BPG



End Table
Soft Square

HSCER24LM
HSCER24LMK
HSCER24BPG



End Table
Round

Available Laminates and Corresponding Edge:

| Laminate | | Edgeband | |
|-------------------|-------------|------------------|-------------|
| Charcoal | S | Charcoal | S |
| Designer White | LDW1 | Designer White | DW |
| Florence Walnut | LFW1 | Florence Walnut | FW |
| Handspun Chestnut | LAHC | Loft | LOFT |
| Handspun Dove | LAHD | Fossil | EH |
| Handspun Pearl | LAHP | Fossil | EH |
| Handspun Slate | LAHS | Charcoal | S |
| Kingswood Walnut | LKI1 | Kingswood Walnut | KI |
| Lowell Ash | LLA1 | Lowell Ash | DL |
| Natural Maple | D | Natural Maple | D |
| Natural Recon | LNR1 | Natural Recon | NR |
| Phantom Ecru | LPE1 | Phantom Ecru | PE |
| Pinnacle | PINC | Pinnacle | PINC |
| Portico Teak | LPT1 | Portico Teak | PT |
| Skyline Walnut | LSW1 | Skyline Walnut | SW |
| Sterling Ash | LSA1 | Sterling Ash | SA |

EDGE & MATERIAL OPTIONS



Laminate
2mm Edge, 3/4" thick

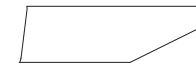

Laminate*
Knife Edge, 1 1/8" thick

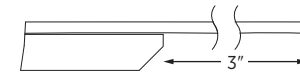

Back-Painted Glass*

- 1/4" thick glass, painted on the bottom surface with frosted/etched top and sides.
- 3/4" MDF sub-top inset 3" from all sides, for attachment to base.

*Coming Soon

WOOD LEG OPTIONS

| CODE | DESCRIPTION | PRICE |
|--------------|------------------|-------------|
| LFW1 | Florence Walnut | +\$0 |
| LKI1 | Kingswood Walnut | +\$0 |
| LLA1 | Lowell Ash | +\$0 |
| D | Natural Maple | +\$0 |
| LNR1 | Natural Recon | +\$0 |
| LPE1 | Phantom Ecru | +\$0 |
| PINC | Pinnacle | +\$0 |
| LPT1 | Portico Teak | +\$0 |
| LSW1 | Skyline Walnut | +\$0 |
| LSA1 | Sterling Ash | +\$0 |
| LE404 | Warm White | +\$0 |
| LE405 | Mist | +\$0 |
| LE408 | Peppercorn | +\$0 |

NOTES: Wood Legs are stained solid maple. Stain finishes will be tonal matches to the respective laminate finishes. Some natural woodgrain may show through the stain; therefore, stained wood legs may have slight variation in appearance.

STRETCHER BAR PAINT OPTIONS

| CODE | DESCRIPTION | PRICE |
|-----------------|--------------------|--------------|
| Grade P1 | | |
| P7A | Textured Charcoal | +\$0 |
| P8V | Textured Titanium | +\$0 |
| Grade P2 | | |
| PR5 | Champagne Metallic | +\$20 |
| P8X | Solar Black | +\$20 |



BACK-PAINTED GLASS OPTION

| CODE | DESCRIPTION | PRICE |
|-------------|-------------------|-------------|
| GWH1 | Ice White, Etched | +\$0 |

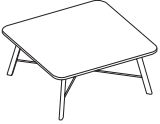

Icon Legend on page 17

SCRAMBLE™ Coffee Tables

| | DESCRIPTION | MODEL | SHIP WEIGHT | CUBE | LIST PRICE BY LAMINATE GRADE | | GLASS LIST PRICE |
|---|---|----------------------|-------------|------|------------------------------|--------|------------------|
| | | | | | L1 | L2 | |
|  | Coffee Table, Soft Rectangle 24"D x 48"W x 16"H, Laminate Top, 2mm Edge | HSCCSR2448LM | 46.5 | 9.7 | \$1333 | \$1353 | |
| | 24"D x 48"W x 16"H, Laminate Top, Knife Edge | HSCCSR2448LMK | 94.0 | 6.4 | \$1599 | \$1619 | |
| | 24"D x 48"W x 16"H, Back-Painted Glass Top | HSCCSR2448BPG | 61.5 | 5.9 | | | \$3076 |
|  | Coffee Table, Soft Square 36"D x 36"W x 16"H, Laminate Top, 2mm Edge | HSCCSS36LM | 48.5 | 9.0 | \$1281 | \$1301 | |
| | 48"D x 48"W x 16"H, Laminate Top, 2mm Edge | HSCCSS48LM | 80.5 | 12.8 | \$1387 | \$1407 | |
| | 36"D x 36"W x 16"H, Laminate Top, Knife Edge | HSCCSS36LMK | 63.0 | 6.7 | \$1494 | \$1514 | |
| | 48"D x 48"W x 16"H, Laminate Top, Knife Edge | HSCCSS48LMK | 96.5 | 9.9 | \$1706 | \$1726 | |
| | 36"D x 36"W x 16"H, Back-Painted Glass Top | HSCCSS36BPG | 66.0 | 6.2 | | | \$3340 |
| 48"D x 48"W x 16"H, Back-Painted Glass Top | HSCCSS48BPG | 110.5 | 9.1 | | | \$3869 | |
|  | Coffee Table, Round 36"D x 16"H, Laminate Top, 2mm Edge | HSCCR36LM | 41.0 | 8.8 | \$1281 | \$1301 | |
| | 48"D x 16"H, Laminate Top, 2mm Edge | HSCCR48LM | 70.0 | 12.6 | \$1387 | \$1407 | |
| | 36"D x 16"H, Laminate Top, Knife Edge | HSCCR36LMK | 49.0 | 6.7 | \$1494 | \$1514 | |
| | 48"D x 16"H, Laminate Top, Knife Edge | HSCCR48LMK | 82.0 | 9.0 | \$1706 | \$1726 | |
| | 36"D x 16"H, Back-Painted Glass Top | HSCCR36BPG | 49.0 | 6.2 | | | \$3340 |
| 48"D x 16"H, Back-Painted Glass Top | HSCCR48BPG | 90.0 | 8.2 | | | \$3869 | |

HOW TO SPECIFY

| | | | |
|---|---|---|--|
| <p>Select Model Number</p> <p>See page 122</p> | <p>Select Laminate and Edge or Glass</p> <p>See page 122</p> | <p>Select Leg Finish</p> <p>See page 122</p> | <p>Select Stretcher Bar Paint Color</p> <p>See page 122</p> |
| H S C C S R 2 4 4 8 L M . | L S A 1 S A . | L S A 1 . | P 8 V |

SCRAMBLE™ End Tables

OPEN MARKET



Icon Legend on page 17



| DESCRIPTION | MODEL | SHIP WEIGHT | CUBE | LIST PRICE BY LAMINATE GRADE | | GLASS LIST PRICE |
|---|---------------------|-------------|------|------------------------------|--------|------------------|
| | | | | L1 | L2 | |
| End Table, Soft Square 24"W x 24"D x 22"H, Laminate Top, 2mm Edge | HSCCESS24LM | 34.5 | 19.0 | \$1227 | \$1247 | |
| 24"W x 24"D x 22"H, Laminate Top, Knife Edge | HSCCESS24LMK | 42.0 | 3.9 | \$1388 | \$1408 | |
| 24"W x 24"D x 22"H, Back-Painted Glass Top | HSCCESS24BPG | 38.0 | 3.7 | | | \$2601 |



| | | | | | | |
|--|-------------------|------|------|--------|--------|--------|
| End Table, Round 24"D x 22"H, Laminate Top, 2mm Edge | HSCER24LM | 32.0 | 19.0 | \$1227 | \$1247 | |
| 24"D x 22"H, Laminate Top, Knife Edge | HSCER24LMK | 33.0 | 3.9 | \$1388 | \$1408 | |
| 24"D x 22"H, Back-Painted Glass Top | HSCER24BPG | 33.0 | 3.7 | | | \$2601 |

HOW TO SPECIFY

| | | | |
|--|--|--|---|
| <p>Select Model Number</p> <p>See page 122</p> <p>H S C E S S 2 4 L M .</p> | <p>Select Laminate and Edge or Glass</p> <p>See page 122</p> <p>L S A 1 S A .</p> | <p>Select Leg Finish</p> <p>See page 122</p> <p>L S A 1 .</p> | <p>Select Stretcher Bar Paint Color</p> <p>See page 122</p> <p>P 8 V</p> |
|--|--|--|---|

UTILITY TABLES

Want to see more? Scan here
to check out hon.com.



Utility Tables shown with Accommodate® Seating.

UTILITY TABLES

All-purpose Utility Tables from HON have a place in every work and educational setting. The Chrome steel legs and square edge detail complement HON 34000 Series desks. The top is scratch-, spill-, and stain-resistant laminate. Adjustable glides won't mar hard-surface floors.



FEATURES

- Scratch-, spill- and stain-resistant laminate stands up to heavy use and is specially treated to withstand boiling liquids.
- Heavy-grade, warp-resistant particleboard withstands high activity.
- Formed steel legs and perimeter frame are built to endure frequent moves and high activity.
- Leveling glides compensate for uneven floors.

UTILITY TABLES ORDERING INFORMATION

LAMINATE

LAMINATES CODES

Woodgrain

- ◆ Bourbon Cherry **H**
- ◆ Cognac **COGN**
- ◆ Florence Walnut **LFW1**
- ◆ Harvest **C**
- ◆ Kingswood Walnut **LKI1**
- ◆ Mahogany **N**
- ◆ Mocha **MOCH**
- ◆ Natural Maple **D**
- ◆ Pinnacle **PINC**
- ◆ Shaker Cherry **F**
- ◆ Sterling Ash **LSA1**

Solid

- ◆ Designer White **LDW1**
- ◆ Loft **LOFT**

Patterned

- ◆ Gray **G2**

PAINT

BASE PAINT CODES

P1

- ◆ Black **P**
- ◆ Brownstone **P7D**
- ◆ Charcoal **S**
- ◆ Designer White **PJW**
- ◆ Fossil **P28**
- ◆ Greige **T5**
- ◆ Loft **LOFT**
- ◆ Muslin **T3**
- ◆ Putty **L**
- ◆ Shadow* **SHDW**
- ◆ Titanium **P8T**

LEG FINISH

BASE PAINT CODES

- ◆ Black **P**
- ◆ Chrome **CHR**

Recommended Edgeband Color Selection:

| Laminate | | Edge | |
|------------------|-------------|------------------|-------------|
| Bourbon Cherry | H | Bourbon Cherry | H |
| Cognac | COGN | Cognac | COGN |
| Florence Walnut | LFW1 | Florence Walnut | FW |
| Harvest | C | Harvest | C |
| Kingswood Walnut | LKI1 | Kingswood Walnut | KI |
| Mahogany | N | Mahogany | N |
| Mocha | MOCH | Mocha | MOCH |
| Natural Maple | D | Natural Maple | D |
| Pinnacle | PINC | Pinnacle | PINC |
| Shaker Cherry | F | Shaker Cherry | F |
| Gray | G2 | Charcoal | S |

◆◆◆ For lead time information see page 17.

* De-emphasized



Icon Legend on page 17

UTILITY TABLES



DESCRIPTION

Rectangle Shaped Utility Table — Metal

72"W x 18"D x 29"H

40"W x 20"D x 29"H

60"W x 20"D x 29"H

60"W x 24"D x 29"H

60"W x 30"D x 29"H

72"W x 30"D x 29"H

72"W x 36"D x 29"H

MODEL

SHIP WEIGHT

CUBE

LIST PRICE

HUTM1872

73 **Ⓢ**

4.8

\$631

HUTM2040

50 **Ⓢ**

3.3

\$522

HUTM2060 **Ⓢ**

68 **Ⓢ**

4.9

\$583

HUTM2460

81 **Ⓢ**

5.6

\$620

HUTM3060 **Ⓢ**

88

6.5

\$637

HUTM3072

106

7.2

\$795

HUTM3672

116

10.4

\$843

NOTES:

- 1/8" thick top with self-edge.
- Adjustable non-marring leveling floor glides.
- 90-degree square corners.
- Legs secured to top with steel corner brace.
- ! 1/4" square Chrome or Black painted legs ONLY.

HOW TO SPECIFY

| | | | |
|---|---|---|---|
| <p>Select Model Number</p> <p>HUTM1872</p> | <p>Select Laminate</p> <p>See page 126</p> <p>MOCH</p> | <p>Select Paint Color</p> <p>See page 126</p> <p>P</p> | <p>Select Leg Paint Color or Finish</p> <p>P Black CHR Chrome</p> <p>CHR</p> |
|---|---|---|---|

CROSS REFERENCE BY APPLICATION

| | Page |
|---|---|
| CLASSROOM | |
| Student Desks | |
| SmartLink® Student Desks | 163-165 |
| Teacher/Administration Desks | |
| SmartLink® Teacher Stations | 170-172 |
| Voi® | <i>See the Desks section in the 2021 Workspaces Pricer.</i> |
| 10700 Series™ | <i>See the Desks section in the 2021 Workspaces Pricer.</i> |
| 10500 Series™ | <i>See the Desks section in the 2021 Workspaces Pricer.</i> |
| Mentor® Series Desks | <i>See the Desks section in the 2021 Workspaces Pricer.</i> |
| 38000 Series™ ... | <i>See the Desks section in the 2021 Workspaces Pricer.</i> |
| Seating | |
| SmartLink® Seating | 166-169 |
| Perpetual® Nesting | 423-425 |
| Olson Stacker® - 4040 Series | |
| High-Density | 409-410 |
| Motivate® Seating | 380-399 |
| Volt® - 5700/5710/5720/5730 Series | 478-485 |
| ComforTask® - 5900 Series | 258-262 |
| Ignition®/Ignition® 2.0 | 327-356 |
| Solve® | 446-457 |
| Convergence® | 263-267 |
| Storage & Files | |
| SmartLink® Modular Storage | 173-175 |
| Brigade® 800 Series Lateral Files | <i>See the Storage section in the 2021 Workspaces Pricer.</i> |
| Brigade® 700 Series Lateral Files | <i>See the Storage section in the 2021 Workspaces Pricer.</i> |
| Brigade® 600 Series Lateral Files | <i>See the Storage section in the 2021 Workspaces Pricer.</i> |
| Lateral File Accessories | <i>See the Storage section in the 2021 Workspaces Pricer.</i> |
| 310 Series Vertical Files - 26½"D | <i>See the Storage section in the 2021 Workspaces Pricer.</i> |
| 510 Series Vertical Files - 25"D | <i>See the Storage section in the 2021 Workspaces Pricer.</i> |
| Flagship® Bookcases and Storage Cabinets | <i>See the Storage section in the 2021 Workspaces Pricer.</i> |
| Brigade® Storage Cabinets | <i>See the Storage section in the 2021 Workspaces Pricer.</i> |
| Brigade® Steel Bookcases | <i>See the Storage section in the 2021 Workspaces Pricer.</i> |
| 10500 Series™ Bookcases | <i>See the Storage section in the 2021 Workspaces Pricer.</i> |
| 1870 Series Bookcases | <i>See the Storage section in the 2021 Workspaces Pricer.</i> |
| Tables | |
| Huddle Multi-Purpose Tables | 54-61 |
| Motivate® Tables | 72-76 |
| Utility Tables | 125-127 |
| Learning Applications | |
| SmartLink® Wall Rail System | 176-177 |
| Motivate® Mobile Markerboards | 76 |
| COMPUTER LAB | |
| Tables | |
| Huddle Multi-Purpose Tables | 54-61 |
| Motivate® Tables | 72-76 |
| Between™ Tables | 33-37 |
| Seating | |
| Motivate® Seating | 380-399 |
| Perpetual® Nesting | 423-425 |

| | Page |
|-----------------------------------|---|
| CAFETERIA | |
| Seating | |
| SmartLink® Seating | 166-169 |
| Motivate® Seating | 380-399 |
| Olson Stacker® - 4040 Series | |
| High-Density | 409-410 |
| Tables | |
| Huddle Multi-Purpose Tables | 54-61 |
| Motivate® Tables | 72-76 |
| Between™ Tables | 33-37 |
| COMMON AREAS | |
| Reception Seating | |
| Flock® Lounge | 284-307 |
| Grove® | 312-323 |
| Accommodate® | 217-223 |
| Invitation® - 2110 Series | 358-361 |
| Cambia™ - 2160 Series | 242-244 |
| Pagoda® - 4070/4090 Series | 411-418 |
| Invitation® Lounge | 362-364 |
| Tables | |
| Huddle Multi-Purpose Tables | 54-61 |
| Motivate® Tables | 72-76 |
| Laminate Occasional Tables | 68 |
| Flock® | 46-51 |
| Between™ Tables | 33-37 |
| LIBRARY / MEDIA CENTER | |
| Storage | |
| Flagship® Bookcases | <i>See the Storage section in the 2021 Workspaces Pricer.</i> |
| Brigade® Steel Bookcases | <i>See the Storage section in the 2021 Workspaces Pricer.</i> |
| SmartLink® Modular Storage | 173-175 |
| Reception Seating | |
| Flock® Lounge | 284-307 |
| Grove® | 312-323 |
| Accommodate® | 217-223 |
| Invitation® - 2110 Series | 358-361 |
| Cambia™ - 2160 Series | 242-244 |
| Pagoda® - 4070/4090 Series | 411-418 |
| Invitation® Lounge | 362-364 |
| Student Seating | |
| SmartLink® Seating | 166-169 |
| Motivate® Seating | 380-399 |
| Accommodate® | 217-223 |
| Tables | |
| Huddle Multi-Purpose Tables | 54-61 |
| Motivate® Tables | 72-76 |
| Laminate Occasional Tables | 68 |
| Flock® | 46-51 |
| Between™ Tables | 33-37 |

CROSS REFERENCE BY APPLICATION

| | Page |
|-----------------------------------|---|
| ART ROOM | |
| Seating | |
| Motivate® Seating | 380-399 |
| Storage | |
| SmartLink® Modular Storage | 173-175 |
| Flagship® Storage Cabinets | <i>See the Storage section in the 2021 Workspaces Pricer.</i> |
| Brigade® Storage Cabinets | <i>See the Storage section in the 2021 Workspaces Pricer.</i> |
| Flagship® Bookcases | <i>See the Storage section in the 2021 Workspaces Pricer.</i> |
| Brigade® Steel Bookcases | <i>See the Storage section in the 2021 Workspaces Pricer.</i> |
| 10500 Series™ Bookcases | <i>See the Storage section in the 2021 Workspaces Pricer.</i> |
| 1870 Series Bookcases | <i>See the Storage section in the 2021 Workspaces Pricer.</i> |
| Tables | |
| Huddle Multi-Purpose Tables | 54-61 |
| Motivate® Tables | 72-76 |

TEACHER PLANNING

| | |
|--|---|
| Desks | |
| SmartLink® Teacher Stations | 170-172 |
| Voi® | <i>See the Desks section in the 2021 Workspaces Pricer.</i> |
| 10700 Series™ | <i>See the Desks section in the 2021 Workspaces Pricer.</i> |
| 10500 Series™ | <i>See the Desks section in the 2021 Workspaces Pricer.</i> |
| Mentor® Series Desks | <i>See the Desks section in the 2021 Workspaces Pricer.</i> |
| 38000 Series™ ... | <i>See the Desks section in the 2021 Workspaces Pricer.</i> |
| Seating | |
| Volt® - 5700/5710/5720/5730 Series | 478-485 |
| ComforTask® - 5900 Series | 258-262 |
| Ignition®/Ignition® 2.0 | 327-356 |
| Solve® | 446-457 |
| Convergence® | 263-267 |
| Storage | |
| SmartLink® Modular Storage | 173-175 |
| Brigade® 800 Series Lateral Files | <i>See the Storage section in the 2021 Workspaces Pricer.</i> |
| Brigade® 700 Series Lateral Files | <i>See the Storage section in the 2021 Workspaces Pricer.</i> |
| Brigade® 600 Series Lateral Files | <i>See the Storage section in the 2021 Workspaces Pricer.</i> |
| Flagship® Lateral Files | <i>See the Storage section in the 2021 Workspaces Pricer.</i> |
| 400 Series Lateral Files | <i>See the Storage section in the 2021 Workspaces Pricer.</i> |
| Lateral File Accessories | <i>See the Storage section in the 2021 Workspaces Pricer.</i> |
| 210 Series Vertical Files - 28½"D | <i>See the Storage section in the 2021 Workspaces Pricer.</i> |
| 310 Series Vertical Files - 26½"D | <i>See the Storage section in the 2021 Workspaces Pricer.</i> |
| 510 Series Vertical Files - 25"D | <i>See the Storage section in the 2021 Workspaces Pricer.</i> |
| Vertical File Accessories | <i>See the Storage section in the 2021 Workspaces Pricer.</i> |
| Flagship® Storage Cabinets | <i>See the Storage section in the 2021 Workspaces Pricer.</i> |
| Brigade® Storage Cabinets | <i>See the Storage section in the 2021 Workspaces Pricer.</i> |
| Flagship® Bookcases | <i>See the Storage section in the 2021 Workspaces Pricer.</i> |
| Brigade® Steel Bookcases | <i>See the Storage section in the 2021 Workspaces Pricer.</i> |
| 10500 Series™ Bookcases | <i>See the Storage section in the 2021 Workspaces Pricer.</i> |
| 1870 Series Bookcases | <i>See the Storage section in the 2021 Workspaces Pricer.</i> |

| | Page |
|-------------------------------------|-------|
| TEACHER PLANNING (continued) | |
| Tables | |
| Huddle Multi-Purpose Tables | 54-61 |
| Motivate® Tables | 72-76 |
| Flock® | 46-51 |
| Between™ Tables | 33-37 |

ADMINISTRATION

| | |
|---|---|
| Desks | |
| 10700 Series™ | <i>See the Desks section in the 2021 Workspaces Pricer.</i> |
| 10500 Series™ | <i>See the Desks section in the 2021 Workspaces Pricer.</i> |
| Mentor® Series Desks | <i>See the Desks section in the 2021 Workspaces Pricer.</i> |
| 38000 Series™ ... | <i>See the Desks section in the 2021 Workspaces Pricer.</i> |
| Reception Seating | |
| Invitation® - 2110 Series | 358-361 |
| Cambia™ - 2160 Series | 242-244 |
| Pagoda® - 4070/4090 Series | 411-418 |
| Task / Administrative Seating | |
| Ignition®/Ignition® 2.0 | 327-356 |
| Motivate® Seating | 380-399 |
| Pillow-Soft® - 2190 Series | 429-431 |
| Volt® - 5700/5710/5720/5730 Series | 478-485 |
| ComforTask® - 5900 Series | 258-262 |
| Solve® | 446-457 |
| Convergence® | 263-267 |
| Storage & Files | |
| SmartLink® Modular Storage | 173-175 |
| Brigade® 800 Series Lateral Files | <i>See the Storage section in the 2021 Workspaces Pricer.</i> |
| Brigade® 700 Series Lateral Files | <i>See the Storage section in the 2021 Workspaces Pricer.</i> |
| Brigade® 600 Series Lateral Files | <i>See the Storage section in the 2021 Workspaces Pricer.</i> |
| Lateral File Accessories | <i>See the Storage section in the 2021 Workspaces Pricer.</i> |
| 310 Series Vertical Files - 26½"D | <i>See the Storage section in the 2021 Workspaces Pricer.</i> |
| 510 Series Vertical Files - 25"D | <i>See the Storage section in the 2021 Workspaces Pricer.</i> |
| Flagship® Bookcases and Storage Cabinets | <i>See the Storage section in the 2021 Workspaces Pricer.</i> |
| Brigade® Storage Cabinets | <i>See the Storage section in the 2021 Workspaces Pricer.</i> |
| Brigade® Steel Bookcases | <i>See the Storage section in the 2021 Workspaces Pricer.</i> |
| 10500 Series™ Bookcases | <i>See the Storage section in the 2021 Workspaces Pricer.</i> |
| 1870 Series Bookcases | <i>See the Storage section in the 2021 Workspaces Pricer.</i> |
| Tables | |
| Huddle Multi-Purpose Tables | 54-61 |
| Motivate® Tables | 72-76 |
| Flock® | 46-51 |
| Between™ Tables | 33-37 |
| Occasional Tables | |
| Laminate Occasional Tables | 68 |
| Flock® | 46-51 |



Build™ Student Desks and Tables shown
with SmartLink® Seating and Storage.

BUILD™

Inspiring the next generation takes a higher degree of mobility and hands-on learning. The Build™ series, an educational product collection of tables, student desks, and seating, is lightweight, durable, reconfigurable, and customizable. Build encourages creativity and adaptability so students can support collaboration and social interaction or create personal space for focused study time. Build supports the movers and shakers, the hands-on doers, and the leaders who crave creativity. The future of education takes shape with Build.



FEATURES

- 15 table shapes and 6 student desk shapes make reconfiguration fun and easy.
- In addition to all standard HON laminates, Build tops are available in bright, bold laminates and a dry-erase markerboard finish to enhance any learning environment. Or try Butcher Block tops on Makerspace tables.
- Table legs are available in multiple height adjustable ranges and nesting bases to accommodate different user applications.
- Adjustable height student desk legs accommodate any students in K-12 grades and beyond.
- The durable Makerspace table features à la carte storage accessories and allows you to keep a creative space clean, organized, and customizable.

BUILD™ ORDERING INFORMATION

LAMINATE GROUP A (TOP LAMINATES)

L1 LAMINATES CODES

Woodgrain

- ◆ Bourbon Cherry H
- ◆ Cognac COGN
- ◆ Florence Walnut LFW1
- ◆ Harvest C
- ◆ Kingswood Walnut LK11
- ◆ Loft LOFT
- ◆ Mahogany N
- ◆ Mocha MOCH
- ◆ Natural Maple D
- ◆ Pinnacle PINC
- ◆ Shaker Cherry F
- ◆ Sterling Ash LSA1

Solid

- ◆ Black P
- ◆ Charcoal S
- ◆ Designer White LDW1
- ◆ Loft LOFT

Patterned

- ◆ Handspun Chestnut LAHC
- ◆ Handspun Dove LAHD
- ◆ Handspun Pearl LAHP
- ◆ Handspun Slate LAHS
- ◆ Sheer Mesh * A5
- ◆ Silver Mesh B9
- ◆ Steel Mesh * A9
- ◆ Canyon Zephyr * K9
- ◆ Desert Zephyr * K8
- ◆ Shadow Zephyr * K1
- ◆ Battleship LBT1
- ◆ Gray G2
- ◆ Grey Tigris * L6
- ◆ Moroccan LMN1
- ◆ Mushroom LMH1
- ◆ Neon Carrot LNC1
- ◆ Tennis Ball LTB1
- ◆ White G1
- ◆ Whitestone * K4

L2 LAMINATES CODES

Woodgrain

- ◆ Lowell Ash LLA1
- ◆ Natural Recon LNR1
- ◆ Phantom Ecru LPE1
- ◆ Portico Teak LPT1
- ◆ Skyline Walnut LSW1

L5 LAMINATES CODES

- ◆ White Markerboard FMQ1

LAMINATE GROUP B (SHELF LAMINATES)

L1 LAMINATES CODES

Woodgrain

- ◆ Bourbon Cherry H
- ◆ Cognac COGN
- ◆ Florence Walnut LFW1
- ◆ Harvest C
- ◆ Kingswood Walnut LK11
- ◆ Mahogany N
- ◆ Natural Maple D
- ◆ Pinnacle PINC
- ◆ Shaker Cherry F
- ◆ Sterling Ash LSA1

Solid

- ◆ Black P
- ◆ Charcoal S
- ◆ Designer White LDW1
- ◆ Loft LOFT

L2 LAMINATES CODES

Woodgrain

- ◆ Lowell Ash LLA1
- ◆ Natural Recon LNR1
- ◆ Phantom Ecru LPE1
- ◆ Portico Teak LPT1
- ◆ Skyline Walnut LSW1

PAINT GROUP A (TABLE AND STUDENT DESK LEG PAINT)

PAINT CODES

- P1**
- ◆ Black P
- P2**
- ◆ Platinum Metallic T1

PAINT GROUP B (MAKERSPACE TABLE BASE AND STOOL)

PAINT CODES

P1

- ◆ Black P
- ◆ Brownstone P7D
- ◆ Charcoal S
- ◆ Designer White PJW
- ◆ Fossil P28
- ◆ Greige T5
- ◆ Loft LOFT
- ◆ Muslin T3
- ◆ Titanium P8T

P2

- ◆ Champagne Metallic T4
- ◆ Platinum Metallic T1
- ◆ Silver PR6

P3

- ◆ Atom P8S
- ◆ Bullseye PJF
- ◆ Ember P8P
- ◆ Ion P8N
- ◆ Iris P8J
- ◆ Krypton P8F
- ◆ Regatta P8M

PAINT GROUP C (MAKERSPACE TABLE END PANEL)

PAINT CODES

P1

- ◆ Black P
- ◆ Brownstone P7D
- ◆ Charcoal S
- ◆ Designer White PJW
- ◆ Fossil P28
- ◆ Greige T5
- ◆ Loft LOFT
- ◆ Muslin T3
- ◆ Titanium P8T

P2

- ◆ Champagne Metallic T4
- ◆ Platinum Metallic T1
- ◆ Silver PR6

P3

- ◆ Atom P8S
- ◆ Bullseye PJF
- ◆ Ember P8P
- ◆ Ion P8N
- ◆ Iris P8J
- ◆ Krypton P8F
- ◆ Regatta P8M

P6

- ◆ Markerboard MKB

MAKERSPACE BUTCHER BLOCK

- ◆ Butcher Block LH903

EDGE

EDGE CODES

Woodgrain

- ◆ Cognac COGN
- ◆ Florence Walnut FW
- ◆ Kingswood Walnut KI
- ◆ Lowell Ash DL
- ◆ Mahogany N
- ◆ Mocha MOCH
- ◆ Natural Maple D
- ◆ Natural Recon NR
- ◆ Phantom Ecru PE
- ◆ Pinnacle PINC
- ◆ Portico Teak DP
- ◆ Shaker Cherry F
- ◆ Skyline Walnut SW
- ◆ Sterling Ash SA

Solid















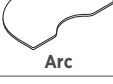

- ◆ Atom AT
- ◆ Black P
- ◆ Brownstone EY
- ◆ Bullseye BY
- ◆ Charcoal S
- ◆ Designer White DW
- ◆ Ember MR
- ◆ Fossil EH
- ◆ Greige R
- ◆ Ion IO
- ◆ Iris IR
- ◆ Krypton KT
- ◆ Loft LOFT
- ◆ Muslin T
- ◆ Platinum K
- ◆ Regatta RE

◆◆◆ For lead time information see page 17.

* De-emphasized

BUILD™ Shape Matrix

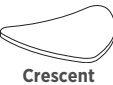
EDUCATION

| Top Shape/Model | Tables | | | | Student Desks |
|---|-------------------------------------|--|--|--------------|--------------------------------------|
| | Youth Height Leg Adjusts 13'-18" | Standard Height Leg Adjusts 22'-34" | Standing Height Leg Adjusts 30'-42" | Nesting Base | Seated Height Leg Adjusts 22'-34" |
|  Kite | X | X | X | | |
|  Ribbon | X | X | X | X | X |
|  Wisp | X | X | X | | |
|  Snap | X | X | X | | |
|  Rectangle | X | X | X | | X |
|  Half-Round | X | X | X | | |
|  Arc | X | X | X | | |
|  Round | X | X | X | | |
|  Square | X | X | X | | |
|  Trapezoid | X | X | X | | X |
|  Horseshoe | X | X | X | | |
|  Home Plate | X | X | X | | |
|  Spooky | X | X | X | X | X |
|  Tide | X | X | X | | |
|  Dart | X | X | X | X | |
|  Crescent | | | | | X |
|  Fin | | | | | X |

Snap



3 PEOPLE/1 TABLE

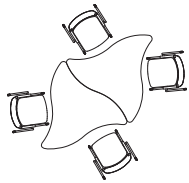

4 PEOPLE/2 TABLES

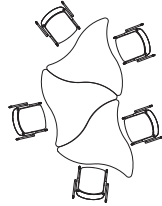

5 PEOPLE/3 TABLES

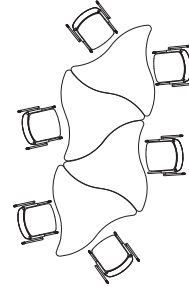

6 PEOPLE/4 TABLES

Tide

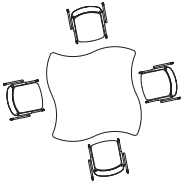

4 PEOPLE/1 TABLE

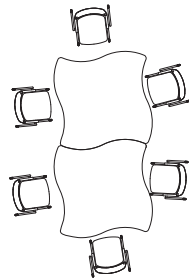

6 PEOPLE/2 TABLES

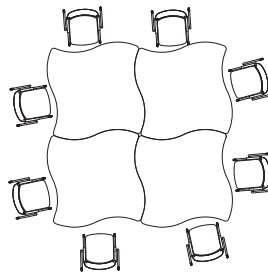

8 PEOPLE/4 TABLES

Kite



2 PEOPLE/1 TABLE

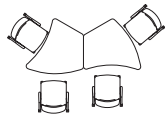

4 PEOPLE/2 TABLES

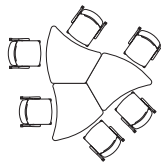

6 PEOPLE/3 TABLES

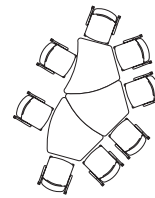

8 PEOPLE/3 TABLES

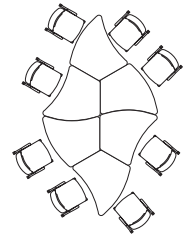

8 PEOPLE/6 TABLES

Dart

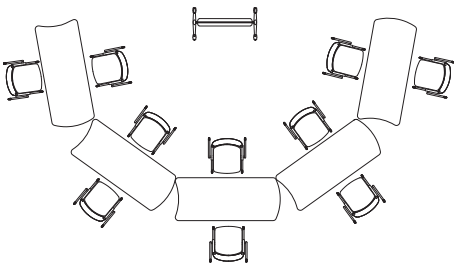

10 PEOPLE/5 TABLES

BUILD™ Table Configurations

EDUCATION

Wisp



4 PEOPLE/1 TABLE

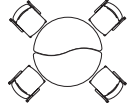

4 PEOPLE/2 TABLES



6 PEOPLE/3 TABLES

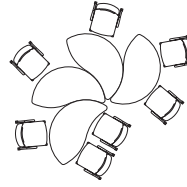

7 PEOPLE/4 TABLES

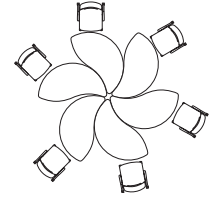

6 PEOPLE/6 TABLES

Ribbon

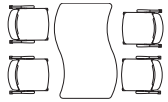

4 PEOPLE/1 TABLE

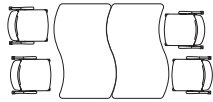

4 PEOPLE/2 TABLES

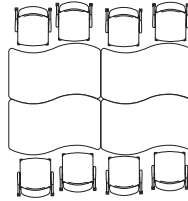

8 PEOPLE/4 TABLES

Home Plate

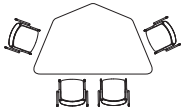

4 PEOPLE/1 TABLE

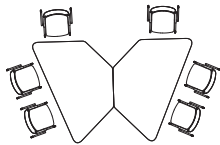

6 PEOPLE/2 TABLES

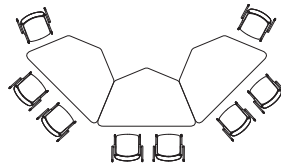

8 PEOPLE/3 TABLES

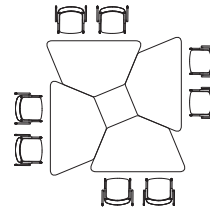

8 PEOPLE/4 TABLES

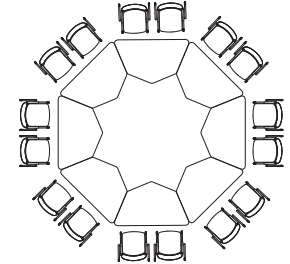

16 PEOPLE/8 TABLES

Horseshoe

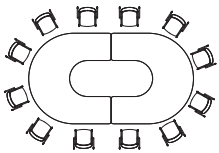

12 PEOPLE/2 TABLES

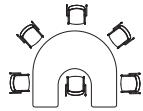

6 PEOPLE/1 TABLE

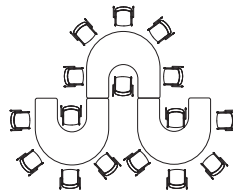

16 PEOPLE/3 TABLES

Spooky



2 PEOPLE/1 TABLE

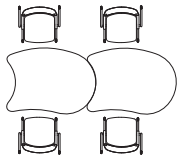

4 PEOPLE/2 TABLES

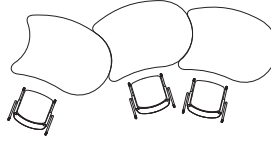

3 PEOPLE/3 TABLES

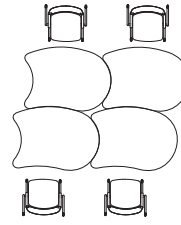

4 PEOPLE/4 TABLES

Combinations

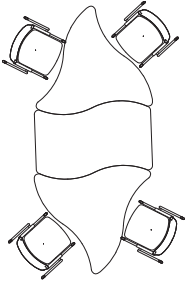

4 PEOPLE/3 TABLES
Ribbon and Snap

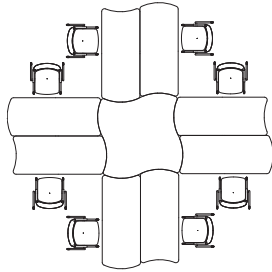

8 PEOPLE/9 TABLES
Tide and Dart

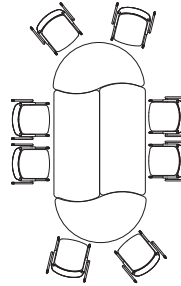

8 PEOPLE/4 TABLES
Dart and Wisp





BUILD™ Table Tops

GSA SIN 33721

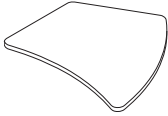

Icon Legend on page 17

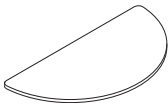
EDUCATION

| | DESCRIPTION | MODEL | LEGS REQUIRED | SHIP WEIGHT | CUBE | LIST PRICE BY LAMINATE GRADE | | |
|---|--|------------------|------------------|----------------|------|------------------------------|--------------|--------------|
| | | | | | | L1 | L2 | L5 |
|  | Snap Table Top 54"W x 34"D | HESNP54E | 3 | 46 | 2.8 | \$507 | \$530 | \$619 |
|  | Kite Table Top 40"W x 24"D | HESA2440E | 4 | 30 | 3.9 | \$486 | \$501 | \$546 |
| | 50"W x 30"D | HESA3050E | 4 | 50 | 5.8 | \$507 | \$527 | \$587 |
|  | Wisp Table Top 54"W x 30"D | HESN3054E | 4 | 63 | 4.6 | \$491 | \$511 | \$571 |
|  | Half-Round Table Top 60"W x 30"D | HESH3060E | 4 | 69 | 6.0 | \$468 | \$488 | \$548 |
|  | Spooky Table Top 36"W x 54"D | HESY3654E | 4 | 61 | 14.4 | \$440 | \$460 | \$538 |
|  | Ribbon Table Top 54"W x 30"D | HESW3054E | 4 | 65 | 5.4 | \$438 | \$458 | \$518 |



NOTES:

- Quick set bracket factory installed for easy leg location and installation.
- Top and legs specified separately.

HOW TO SPECIFY

| | | | |
|--|---|---|--|
| <p>Select Model Number</p> <p>H E S H 3 0 6 0 E .</p> | <p>Select Grommet</p> <p>N No Grommet</p> <p>N .</p> | <p>Select Top Laminate</p> <p>See page 131, Group A</p> <p>L D W 1 .</p> | <p>Select Edge Color</p> <p>See page 131</p> <p>L D W 1</p> |
|--|---|---|--|

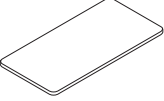
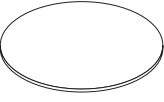
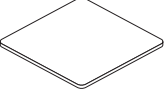

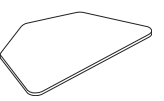
| | DESCRIPTION | MODEL | LEGS REQUIRED | SHIP WEIGHT | CUBE | LIST PRICE BY LAMINATE GRADE | | |
|---|-----------------------------|------------------|------------------|----------------|------|------------------------------|--------------|--------------|
| | | | | | | L1 | L2 | L5 |
|  | Rectangle Table Top | | | | | | | |
| | 48"W x 24"D | HETR2448E | 4 | 71.0 | 3.6 | \$371 | \$386 | \$431 |
| | 60"W x 24"D | HETR2460E | 4 | 57.0 | 4.4 | \$412 | \$432 | \$492 |
| | 72"W x 24"D | HETR2472E | 4 | 68.0 | 4.9 | \$456 | \$476 | \$536 |
| | 48"W x 30"D | HETR3048E | 4 | 62.0 | 4.4 | \$388 | \$403 | \$448 |
| | 60"W x 30"D | HETR3060E | 4 | 71.0 | 5.4 | \$424 | \$444 | \$504 |
| | 72"W x 30"D | HETR3072E | 4 | 85.0 | 4.9 | \$485 | \$505 | \$565 |
|  | Round Table Top | | | | | | | |
| | 42" Diameter | HERD42E | 4 | 51.0 | 4.7 | \$332 | \$347 | \$405 |
| | 48" Diameter | HERD48E | 4 | 66.0 | 6.1 | \$374 | \$391 | \$456 |
|  | Square Table Top | | | | | | | |
| | 36"W x 36"D | HESQ36E | 4 | 46.0 | 3.7 | \$282 | \$295 | \$344 |
| | 42"W x 42"D | HESQ42E | 4 | 61.0 | 4.9 | \$362 | \$378 | \$442 |
| | 48"W x 48"D | HESQ48E | 4 | 76.0 | 6.2 | \$396 | \$414 | \$483 |
|  | Tide Table Top | | | | | | | |
| | 54"W x 54"D | HETD54E | 4 | 106.0 | 9.2 | \$622 | \$650 | \$759 |
|  | Trapezoid Table Top | | | | | | | |
| | | HETZ3060E | 4 | 58.1 | 4.8 | \$351 | \$367 | \$428 |
| | | | | | | | | |
| | | | | | | | | |
| | | | | | | | | |
| | | | | | | | | |
| | | | | | | | | |
| | | | | | | | | |
|  | Home Plate Table Top | | | | | | | |
| | 36"W x 60"D | HEHP3660E | 4 | 64.0 | 15.9 | \$424 | \$444 | \$504 |

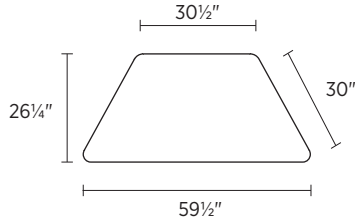

NOTES:

- Quick set bracket factory installed for easy leg location and installation.
- Top and legs specified separately.

HOW TO SPECIFY

| | | | |
|--|---|---|--|
| <p>Select Model Number</p> <p>H E T R 2 4 4 8 E .</p> | <p>Select Grommet</p> <p>N No Grommet</p> <p>N .</p> | <p>Select Top Laminate</p> <p>See page 131, Group A</p> <p>L D W 1 .</p> | <p>Select Edge Color</p> <p>See page 131</p> <p>L D W 1</p> |
|--|---|---|--|



BUILD™ Table Tops

GSA SIN 33721

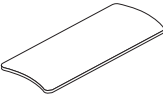

Icon Legend on page 17

EDUCATION

| | DESCRIPTION | MODEL | LEGS REQUIRED | SHIP WEIGHT | CUBE | LIST PRICE BY LAMINATE GRADE | | |
|--|---|-------------------|------------------|----------------|------|------------------------------|--------------|---------------|
| | | | | | | L1 | L2 | L5 |
|  | Dart Table Top 36"W x 60"D | HEDRT2766E | 4 | 86 | 4.3 | \$444 | \$464 | \$542 |
|  | Arc Table Top 72"W x 48"D | HESKD4872E | 4 | 112 | 8.2 | \$711 | \$731 | \$791 |
|  | Horseshoe Table Top 60"W x 66"D | HESH6066E | 4 | 103 | 21.7 | \$843 | \$883 | \$1002 |



NOTES:

- Quick set bracket factory installed for easy leg location and installation.
- Top and legs specified separately.

HOW TO SPECIFY

| | | | |
|--|---|---|--|
| <p>Select Model Number</p> <p>H E S H 6 0 6 6 E .</p> | <p>Select Grommet</p> <p>N No Grommet</p> <p>N .</p> | <p>Select Top Laminate</p> <p>See page 131, Group A</p> <p>L D W 1 .</p> | <p>Select Edge Color</p> <p>See page 131</p> <p>L D W 1</p> |
|--|---|---|--|

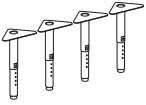
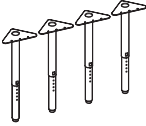

| | DESCRIPTION | MODEL | HEIGHT RANGE | SHIP WEIGHT | CUBE | LIST PRICE P1/P2 |
|---|---|-----------------|--------------|-------------|------|------------------|
|  | Build™ Table Adjustable Height Leg Pack Youth Height Legs, Pack of 4 | HEBY4LEG | 13"-18" | 19 | 0.9 | \$159 |
|  | Build™ Table Adjustable Height Leg Pack Standard Table Height Legs, Pack of 4 | HEB4LEG | 22"-34" | 19 | 1.2 | \$210 |
|  | Build™ Table Adjustable Height Leg Pack Standing Height Legs, Pack of 4 | HEBS4LEG | 30"-42" | 25 | 2.2 | \$259 |

NOTES:

- Specify paint for upper portion of leg. Bottom is chrome.

| CASTER COMPATIBILITY CHART | | |
|----------------------------|-----|----|
| | Yes | No |
| Standing | | X |
| Youth | X | |
| Table | X | |

! See pages 136-138 for number of legs required per top. Legs always ship 4 per carton. Use chart below for quantity of 4-leg packs required for shapes that utilize three legs.

| DESKS | LEGS NEEDED | ADJUSTABLE POST LEGS 4-PACKS |
|-------|-------------|------------------------------|
| 1 | 3 | 1 |
| 2 | 6 | 2 |
| 3 | 9 | 3 |
| 4 | 12 | 3 |
| 5 | 15 | 4 |
| 6 | 18 | 5 |
| 7 | 21 | 6 |
| 8 | 24 | 6 |
| 9 | 27 | 7 |
| 10 | 30 | 8 |

HOW TO SPECIFY

| | |
|----------------------------|-----------------------------|
| Select Model Number | Select Paint Color |
| | See page 131, Paint Group A |
| H E B S 4 L E G . | T 1 |

BUILD™ Nesting Tables

GSA SIN 33721



Icon Legend on page 17

EDUCATION



DESCRIPTION

Dart Table with Nesting Base
66"W x 27"D

MODEL

HEDRT-2766E-NS

SHIP WEIGHT

113

CUBE

8.7

LIST PRICE BY LAMINATE GRADE

L1

\$1119

L2

\$1139

L5

\$1217

NOTES: Ribbon, Wisp, Snap, Tide and Dart can all be used together.

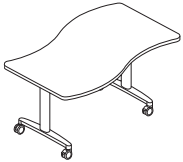

Ribbon Nesting Table
54"W x 30"D

HESW-3054E-NS

89

8.1

\$1109

\$1129

\$1189



Spooky Nesting Table
54"W x 36"D

HESY-3654E-NS

85

17.1

\$1115

\$1135

\$1213

DESCRIPTION

Nesting Spacer Kit

MODEL

HESPCR

SHIP WEIGHT

2 Ⓞ

CUBE

0.1

LIST PRICE

\$55

NOTES: Use with Build™ standard height post legs and nesting bases to create even table heights. Specify 1 kit per nesting table.

ⓘ Available in P Black only. Specify: HESPCR.P.



NOTES:

- ⓘ Nesting bases are not intended to be used in combination with youth, standing, or desk post-legs.
- ⓘ Nesting bases have a height difference of 1/2" when used with Build™ Standard Table Height Post Leg models. Use Nesting Spacer Kit HESPCR to create even table heights.

| | | | | | |
|---|---|--|--|---|---|
| <p>Select Model Number</p> <p>HEDRT-2766E-NS</p> | <p>Select Grommet</p> <p>N No Grommet</p> <p>N</p> | <p>Select Laminate Color</p> <p>See page 131, Group A</p> <p>LBA1</p> | <p>Select Edge Color</p> <p>See page 131</p> <p>K</p> | <p>Select Caster</p> <p>C Caster ONLY</p> <p>C</p> | <p>Select Paint Color</p> <p>See page 131, Paint Group A</p> <p>T1</p> |
|---|---|--|--|---|---|



| | DESCRIPTION | MODEL | SHIP WEIGHT | CUBE | LIST PRICE |
|---|---|--------------------|-------------|------|--------------|
|  OPEN MARKET | Book Box Bracket NOTES: Use with HFMBIN3 trays. Specify 1 bracket per tray. For full book box solution specify both HEBBXRL and HFMBIN3. ⓘ Available in P Black only. No specification needed. ⓘ Minimum mounting clearance required: 13½"W x 15"D. | HEBBXRL | 2.1 | 0.6 | \$44 |
|  SIN 33721 | Accessories — Tray Kit 3"H, 2 bins and 4 rails NOTES: For full book box solution specify both HEBBXRL and HFMBIN3. (1) HFMBIN3 needed for every (2) HEBBXRL as bins are ordered in a set of 2. ⓘ Semi-translucent white. No specification needed. ⓘ Bins ship with rails intended for use in storage. When bins are used with Book Box Bracket, rails will not be used. | HFMBIN3 | 7.0 ⓘ | 4.0 | \$59 |
|  SIN 33721  | Locking Casters, 4-Pack <ul style="list-style-type: none"> • Black only • 4 casters per pack • Caster pack adds 1⅞" to the overall height. • All casters lockable • Threaded attachment bolts • Can retrofit on Build™ units with glides. ⓘ For use on youth and standard table post legs only. * On 4-leg Build™ tables, can utilize 2 casters and 2 glides for easy repositioning of tables. | HHABCASTER* | 1.0 | 0.1 | \$80 |
|  SIN 33721 | Ganging Hardware <ul style="list-style-type: none"> • Includes two ganging links and two screws • No color designator when specifying. <i>Example: HMAGANG.</i> | HMAGANG | 1.0 ⓘ | 0.1 | \$102 |
|  OPEN MARKET     | Back Pack Hook (10 per carton) 12"W x 14½"D x 1½"H NOTES: Attaches to bottom of surface with 2 screws, included. ⓘ Available in Platinum Metallic finish only, no specification needed. | HCLA65 | 10.0 ⓘ | 0.1 | \$101 |

NOTES:

ⓘ See Workplace Tools Pricer for compatible electrical components.

HOW TO SPECIFY

Select Model Number

H H A B C A S T E R

BUILD™ Student Desk Surface Dimensions

EDUCATION

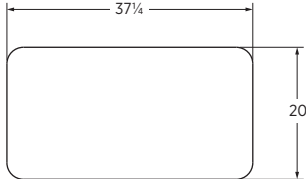
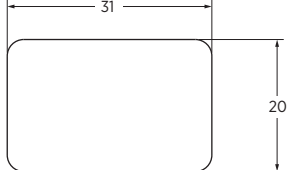
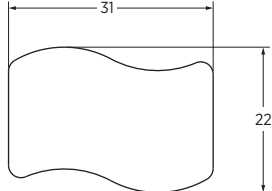
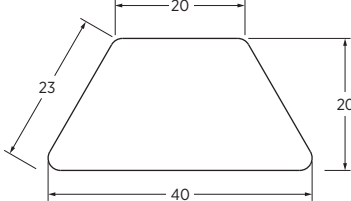
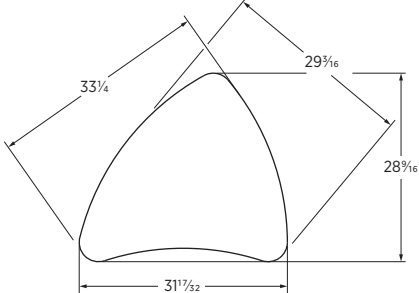
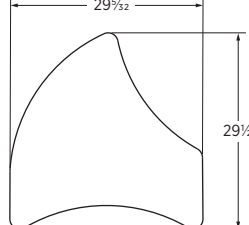
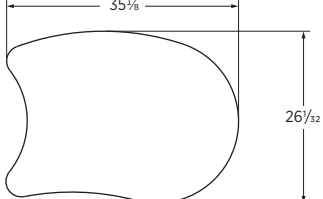
| Name | Model | Dimensions |
|-----------|--------------|--|
| Rectangle | HBSDRECT2038 |  |
| Rectangle | HBSDRECT2031 |  |
| Ribbon | HBSDRBN2231 |  |
| Trapezoid | HBSDTRP2040 |  |
| Crescent | HBSDCSNT2832 |  |
| Fin | HBSDFN3030 |  |
| Spooky | HBSDSPY2636 |  |

Fin

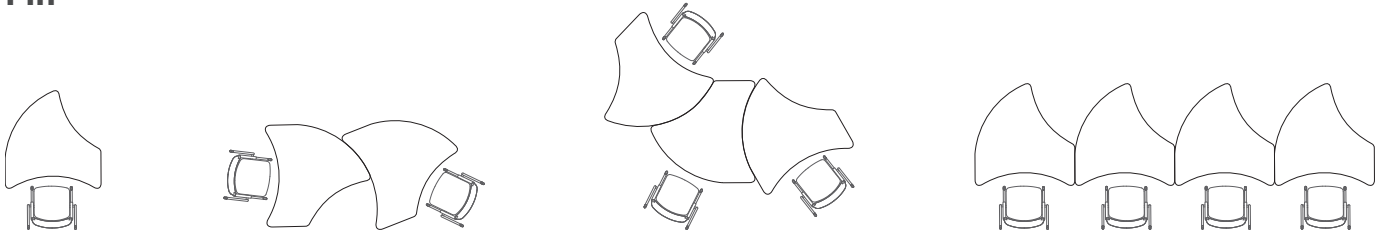

Crescent

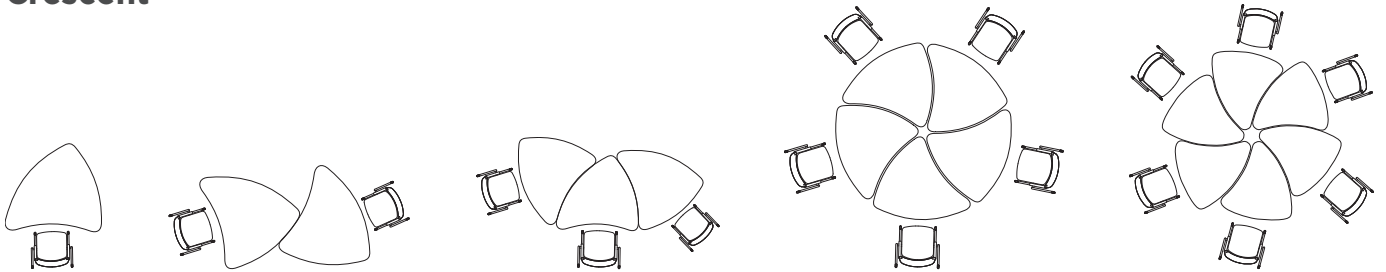

Trapezoid

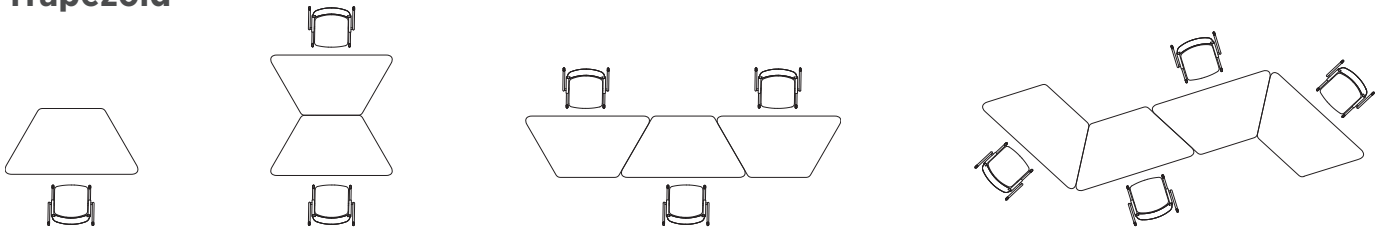

Spooky

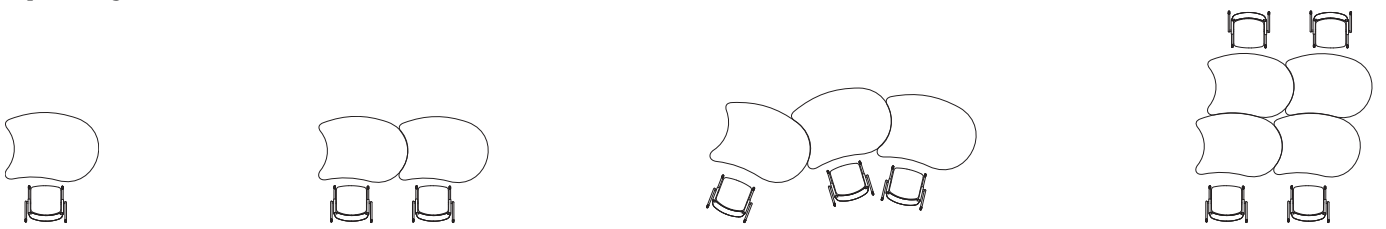

BUILD™ Student Desk Configurations

Rectangle

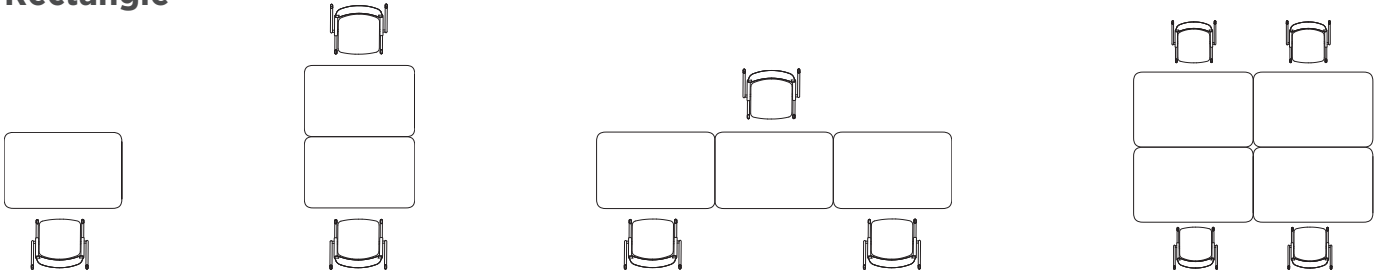

Ribbon

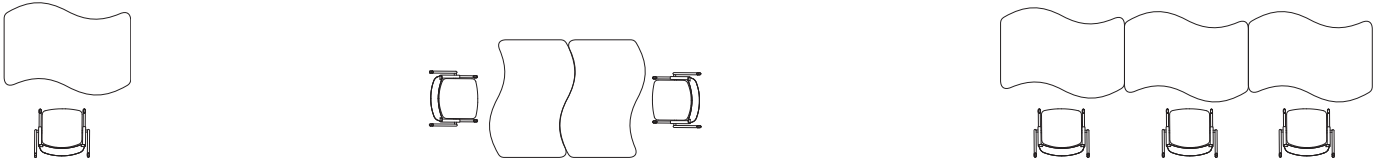



BUILD™ Student Desks

| | DESCRIPTION | MODEL | LEGS REQUIRED | SHIP WEIGHT | CUBE | LIST PRICE BY LAMINATE GRADE | | |
|---|--|----------------------|------------------|----------------|------|------------------------------|-------|-------|
| | | | | | | L1 | L2 | L5 |
| | Rectangle Student Desk Top 31"W x 20"D | HBSDRECT2031 | 4 | 29 | 2.4 | \$183 | \$192 | \$218 |
| | 38"W x 20"D | HBSDRECT2038* | 4 | 33 | 2.0 | \$187 | \$196 | \$222 |
| * HBSDRECT2038 desk is wheelchair friendly. | | | | | | | | |
| | Trapezoid Student Desk Top 40"W x 20"D | HBSDTRP2040 | 4 | 29 | 5.8 | \$211 | \$221 | \$251 |
| | Ribbon Student Desk Top 31"W x 22"D | HBSDRBN2231 | 4 | 27 | 2.2 | \$187 | \$196 | \$222 |
| | Spooky Student Desk Top 36"W x 26"D | HBSDSPY2636 | 4 | 32 | 6.5 | \$211 | \$221 | \$251 |
| | Fin Student Desk Top 30"W x 30"D | HBSDFN3030 | 3 | 26 | 5.7 | \$208 | \$218 | \$247 |
| | Crescent Student Desk Top 32"W x 28"D | HBSDCNT2832 | 3 | 28 | 5.7 | \$208 | \$218 | \$247 |

NOTES:

- Top and legs specified separately.

HOW TO SPECIFY

| | | | |
|--|---|---|--|
| <p>Select Model Number</p> <p>H B S D R B N 2 2 3 1 .</p> | <p>Select Grommet</p> <p>N No Grommet</p> <p>N .</p> | <p>Select Top Laminate</p> <p>See page 131, Group A</p> <p>L D W 1 .</p> | <p>Select Edge Color</p> <p>See page 131</p> <p>D W</p> |
|--|---|---|--|

BUILD™ Student Desks

OPEN MARKET



Icon Legend on page 17

DESCRIPTION

Student Desk Leg, 4-Pack

MODEL

HEBSD4LEG

HEIGHT RANGE

22"-34"

SHIP WEIGHT

15

CUBE

1.1

LIST PRICE P1/P2

\$187



NOTES:

- Specify paint for upper portion of leg. Bottom is chrome.

ⓘ Student desk legs not compatible with casters.

ⓘ See page 145 for number of legs required per top. Legs always ship 4 per carton. Use chart below for quantity of 4-leg packs required for shapes that utilize three legs.

| DESKS | LEGS NEEDED | ADJUSTABLE POST LEGS 4-PACKS |
|-------|-------------|------------------------------|
| 1 | 3 | 1 |
| 2 | 6 | 2 |
| 3 | 9 | 3 |
| 4 | 12 | 3 |
| 5 | 15 | 4 |
| 6 | 18 | 5 |
| 7 | 21 | 6 |
| 8 | 24 | 6 |
| 9 | 27 | 7 |
| 10 | 30 | 8 |

EDUCATION

HOW TO SPECIFY



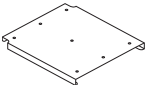

| | |
|---|--|
| <p>Select Model Number</p> <p>HEBSD4LEG</p> | <p>Select Paint Color</p> <p>See page 131, Paint Group A</p> <p>T1</p> |
|---|--|

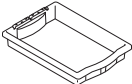

| | DESCRIPTION | MODEL | SHIP WEIGHT | CUBE | LIST PRICE |
|---|--|----------------|-------------|------|-------------|
|  OPEN MARKET | Book Box Bracket NOTES: Use with HFMBIN3 trays. Specify 1 bracket per tray. For full book box solution specify both HEBBXRL and HFMBIN3. ⓘ Available in P Black paint only. ⓘ Minimum mounting clearance required: 13½"W x 15"D. | HEBBXRL | 2.1 | 0.6 | \$44 |

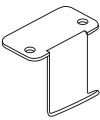
| | | | | | |
|---|--|----------------|--------------|-----|-------------|
|  SIN 33721 | Accessories – Tray Kit 3"H, 2 bins and 4 rails NOTES: For full book box solution specify both HEBBXRL and HFMBIN3. (1) HFMBIN3 needed for every (2) HEBBXRL as bins are ordered in a set of 2. ⓘ Semi-translucent white. No specification needed. ⓘ Bins ship with rails intended for use in storage. When bins are used with Book Box Bracket, rails will not be used. | HFMBIN3 | 7.0 Ⓢ | 4.0 | \$59 |
|---|--|----------------|--------------|-----|-------------|

- NOTES:**
- Front and rear handles are integrated for easy handling/transport.
 - Translucent material provides visibility to contents.

| | DESCRIPTION | MODEL | SHIP WEIGHT | CUBE | LIST PRICE |
|--|---|---------------|-------------|------|--------------|
|  OPEN MARKET     | Back Pack Hook (10 per carton) 12"W x 14½"D x 1½"H NOTES: Attaches to bottom of surface with 2 screws, included. ⓘ Available in Platinum Metallic finish only, no specification needed. | HCLA65 | 10 Ⓢ | 0.1 | \$101 |

HOW TO SPECIFY

| | |
|--|-------------------------|
| Select Model Number H E B B X R L . | Select Paint Color P |
|--|-------------------------|

BUILD™ Makerspace Table

GSA SIN 33721



Icon Legend on page 17

EDUCATION



| DESCRIPTION | MODEL | SHIP WEIGHT | CUBE | LIST PRICE | UPCHARGE BY LAMINATE/PAINT GRADE | | | | |
|---|----------------------|-------------|------|---------------|----------------------------------|--------------|-------------|-------------|--|
| | | | | | L2 | L5 | P2 | P3 | |
| Seated-Height Table with Laminate Top | | | | | | | | | |
| 60"W x 42"D x 29"H | HEMKR426029L | 153 | 9.4 | \$1801 | \$34 | \$133 | \$32 | \$52 | |
| 72"W x 42"D x 29"H | HEMKR427229L | 169 | 9.7 | \$1963 | \$41 | \$163 | \$32 | \$52 | |
| Seated-Height Table with Butcher Block Top | | | | | | | | | |
| 60"W x 42"D x 29"H | HEMKR426029BB | 179 | 9.9 | \$2552 | N/A | N/A | \$32 | \$52 | |
| 72"W x 42"D x 29"H | HEMKR427229BB | 201 | 10.4 | \$2840 | N/A | N/A | \$32 | \$52 | |



| | | | | | | | | | |
|--|----------------------|-----|------|---------------|-------------|--------------|-------------|-------------|--|
| Counter-Height Table with Laminate Top | | | | | | | | | |
| 60"W x 42"D x 36"H | HEMKR426036L | 158 | 10.4 | \$1831 | \$34 | \$133 | \$32 | \$53 | |
| 72"W x 42"D x 36"H | HEMKR427236L | 174 | 10.8 | \$1993 | \$41 | \$163 | \$32 | \$53 | |
| Counter-Height Table with Butcher Block Top | | | | | | | | | |
| 60"W x 42"D x 36"H | HEMKR426036BB | 184 | 11.0 | \$2582 | N/A | N/A | \$32 | \$53 | |
| 72"W x 42"D x 36"H | HEMKR427236BB | 213 | 12.9 | \$2870 | N/A | N/A | \$32 | \$53 | |



| | | | | | | | | | |
|---|----------------------|-----|------|---------------|-------------|--------------|-------------|-------------|--|
| Standing-Height Table with Laminate Top | | | | | | | | | |
| 60"W x 42"D x 42"H | HEMKR426042L | 173 | 11.4 | \$1862 | \$34 | \$133 | \$33 | \$55 | |
| 72"W x 42"D x 42"H | HEMKR427242L | 189 | 11.7 | \$2024 | \$41 | \$163 | \$33 | \$55 | |
| Standing-Height Table with Butcher Block Top | | | | | | | | | |
| 60"W x 42"D x 42"H | HEMKR426042BB | 199 | 11.9 | \$2613 | N/A | N/A | \$33 | \$55 | |
| 72"W x 42"D x 42"H | HEMKR427242BB | 221 | 12.4 | \$2901 | N/A | N/A | \$33 | \$55 | |

NOTES:

- Laminate top is 1/8" thick and features 3" radius corners.
- Butcher Block top is 1 1/2" thick and features 1/2" radius corners with 1/8" radius around entire perimeter of top.
- Butcher Block tops will naturally feature variation between tops due to the nature of the real wood finish. Constructed of natural Birch wood, no two tops are exactly alike. Top is coated in a clear polyurethane finish for maximum durability.
- Both laminate and Butcher Block tops include threaded metal inserts for easy base connection. This also allows for easy base removal and reconnection if table needs to be moved through standard doorways.
- Up to 4 SmartLink® bins will fit between lower foot rails on standing-height table if desired. Compatible with all 3 heights.

HOW TO SPECIFY

| | | | | | |
|---|---------------------------------------|--|---|-----------------------------------|---|
| Select Model Number H E M K R 4 2 7 2 2 9 L | Select Grommet N No Grommet | Select Laminate Color See page 131, Group A L S A 1 | Select Edge Color See page 131 S A | Select Caster C Casters | Select Paint Color See page 131, Paint Group B P |
|---|---------------------------------------|--|---|-----------------------------------|---|

| | | | | |
|---|---------------------------------------|--|-----------------------------------|---|
| Select Model Number H E M K R 4 2 7 2 2 9 B B | Select Grommet N No Grommet | Select Wood LH903 Butcher Block L H 9 0 3 | Select Caster C Casters | Select Paint Color See page 131, Paint Group B P |
|---|---------------------------------------|--|-----------------------------------|---|



BUILD™ Makerspace Table

| | DESCRIPTION | MODEL | SHIP WEIGHT | CUBE | LIST PRICE BY PAINT GRADE | | | |
|--|--|----------------------|-------------|------|---------------------------|-------|-------|-------|
| | | | | | P1 | P2 | P3 | P6 |
| | Slotted/Pegboard End Panels For Seated-Height (2/pack) | HEMKREND29-SP | 29 | 2.6 | \$464 | \$478 | \$486 | \$552 |
| | For Counter-Height (2/pack) | HEMKREND36-SP | 29 | 2.7 | \$520 | \$535 | \$545 | \$618 |
| | For Standing-Height (2/pack) | HEMKREND42-SP | 33 | 3.3 | \$579 | \$596 | \$607 | \$688 |
| | Solid Full End Panels For Seated-Height (2/pack) | HEMKREND29-F | 29 | 2.6 | \$464 | \$478 | \$486 | \$552 |
| | For Counter-Height (2/pack) | HEMKREND36-F | 29 | 2.7 | \$520 | \$535 | \$545 | \$618 |
| | For Standing-Height (2/pack) | HEMKREND42-F | 33 | 3.3 | \$579 | \$596 | \$607 | \$688 |

NOTES:

- Panels ship 2 per carton.
- Slotted/pegboard end panels accept Fuse™ hanging accessories or any standard ¼" pegboard accessory.
- End panels are magnetic.
- End panels feature welded vertical stiffener on inside of panel for maximum rigidity.
- End panels are installed after table is fully built allowing you to add on to table base at a later date if desired.
- End panels are non-handed.

| STANDING-HEIGHT TABLES | |
|------------------------|-------|
| Top Slot | 8¾"W |
| 2nd Slot | 10¼"W |
| 3rd Slot | 11¾"W |
| 4th Slot | 13¼"W |

| SEATED HEIGHT TABLES | |
|----------------------|-------|
| Top Slot | 12¼"W |
| Bottom Slot | 13¾"W |

HOW TO SPECIFY

| | |
|--|---|
| <p>Select Model Number</p> <p>HEMKREND29-SP.P</p> | <p>Select Paint Color</p> <p>See page 131, Paint Group C</p> |
|--|---|

BUILD™ Makerspace Table

GSA SIN 33721



Icon Legend on page 17

EDUCATION

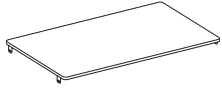

| DESCRIPTION | MODEL | SHIP WEIGHT | CUBE | LIST PRICE | UPCHARGE BY LAMINATE/PAINT GRADE | | |
|--|-------------------|-------------|------|------------|----------------------------------|-----|------|
| | | | | | L2 | P2 | P3 |
| Makerspace Table Shelf 50½"W x 31"D ⓘ For use with standing-height tables only. | HEMKRSHELF | 39 | 1.1 | \$671 | \$21 | \$7 | \$11 |

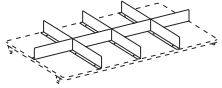

| DESCRIPTION | MODEL | SHIP WEIGHT | CUBE | LIST PRICE BY PAINT GRADE | | |
|----------------------|---------------------|-------------|------|---------------------------|-------|-------|
| | | | | P1 | P2 | P3 |
| Shelf Divider | HEMKRDIVIDER | 10 | 0.6 | \$168 | \$173 | \$176 |

NOTES:

- Shelves are ¾" thick thermal-fused laminate with 1mm edgeband. Edge color is predetermined by and matches laminate selection.
- Shelf can be used with or without divider (specified separately).
- Shelf always contains small pilot through-holes for shelf divider installation.

HOW TO SPECIFY

| | | |
|--|--|---|
| Select Model Number HEMKRSHELF | Select Laminate Color See page 131, Laminate Group B LDW1 | Select Paint Color See page 131, Paint Group B P |
|--|--|---|

| | |
|--|---|
| Select Model Number HEMKRDIVIDER | Select Paint Color See page 131, Paint Group B P |
|--|---|



Icon Legend on page 17

Makerspace Table Accessories

| | DESCRIPTION | MODEL | SHIP WEIGHT | CUBE | LIST PRICE |
|---|--|--------|-------------|------|------------|
|  | Side Saddle 12¼"W x 2½"D x 4"H | HAESS | 0.6 | 0.1 | \$42 |
|  | Hook 1⅝"W x 2¼"D x 3¼"H | HAECBH | 0.1 | 0.1 | \$28 |
|  | Hot File 12¼"W x 3⅞"D x 9½"H | HAEHF | 0.7 | 1.5 | \$62 |

NOTES:

- Hook weight limit 20 lbs.

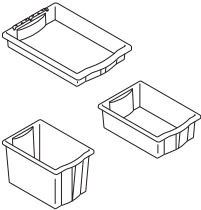
| | DESCRIPTION | MODEL | SHIP WEIGHT | CUBE | LIST PRICE |
|--|-------------------------------|----------|-------------|------|------------|
|  | Accessories — Tray Kit | | | | |
| | 3"H, 2 bins and 4 rails | HFMBIN3 | 7 Ⓢ | 4.0 | \$59 |
| | 6"H, 2 bins and 4 rails | HFMBIN6 | 10 Ⓢ | 4.5 | \$72 |
| | 12"H, 2 bins and 4 rails | HFMBIN12 | 12 Ⓢ | 5.0 | \$84 |

SIN 33721

NOTES:

- ! Semi-translucent white. No specification needed.
- ! Bins ship with metal rails intended for use in SmartLink® Value Mobile Storage. When bins are used with shelf or foot rails on Makerspace table, rails will not be used.

HOW TO SPECIFY

| | |
|----------------------------|---------------------|
| Select Model Number | Select Color |
| HAESS | DW Designer White |

BUILD™ Makerspace Stools

OPEN MARKET



Icon Legend on page 17

EDUCATION



| MODEL/DESCRIPTION | DEPTH | WIDTH | HEIGHT | SHIP | | LIST PRICE BY PAINT GRADE | | |
|---|-------|-------|--------|--------|------|---------------------------|-------|-------|
| | | | | WEIGHT | CUBE | P1 | P2 | P3 |
| HE4LSTL18 Seated-Height Stool | | | | 12 | 3.3 | \$154 | \$159 | \$162 |
| Maximum: | 15½ | 15½ | 18 | | | | | |
| Seat: | 12 | 12 | 18 | | | | | |
| Seat to Floor: | | | 18 | | | | | |
| Usable Seat Depth: | 12 | | | | | | | |



| | | | | | | | | |
|---------------------------------------|-----|-----|----|----|-----|-------|-------|-------|
| HE4LSTL30 Café-Height Stool | | | | 17 | 7.6 | \$208 | \$214 | \$218 |
| Maximum: | 16⅞ | 16⅞ | 30 | | | | | |
| Seat: | 12 | 12 | 30 | | | | | |
| Seat to Floor: | | | 30 | | | | | |
| Usable Seat Depth: | 12 | | | | | | | |

NOTES:

- Weight Rating: 300 lbs.
- Features non-leveling nylon glides.
- Stackable up to 4-high.

HOW TO SPECIFY

| | |
|----------------------------|-----------------------------|
| Select Model Number | Select Paint Color |
| | See page 131, Paint Group B |
| HE4LSTL18 | T1 |



Revel™ Fidget Stools shown with Build™ Student Desks and SmartLink® Seating.

REVEL™

Revel in the movement and give classroom fidgeting a new meaning. Move side to side, back and forth, or spin in a full circle. Revel brings movement and mobility to active learners.



FEATURES

- Seat available in 3 colors, base available in 1.
- Adjust stool height with the push of a button. Stool ranges in height from 13¾”H-18½”H.
- With a slip resistant base and plastic body, you can feel comfortable using the stool in your most creative space with easy cleanup afterwards.
- Tested to hold up to 250 lbs.
- Backed by the HON Full Lifetime Warranty.

REVEL™ Stool

OPEN MARKET



Icon Legend on page 17

HEFS01

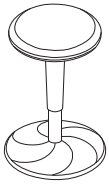

ADJUSTABLE HEIGHT FIDGET STOOL

DIMENSIONS

| | | | |
|-------------|--|----------------|--|
| Depth: | 15 ³ / ₈ | Seat Height: | 13 ³ / ₄ -18 ¹ / ₂ |
| Width: | 15 ³ / ₈ | Ship Weight: | 20.1 |
| Height: | 13 ³ / ₄ -18 ¹ / ₂ | Cube: | 1.4 |
| Seat Depth: | 15 ³ / ₈ | Weight Rating: | 250 lbs. |
| Seat Width: | 15 ³ / ₈ | | |

LIST PRICE

\$265

NOTES: Two buttons integrated in underside of seat for height adjustment control while maintaining a clean aesthetic. Stool seat and base are all plastic for easy cleanability. Anti-slip rubber attached to underside of base allows for comfortable movement of user while maintaining contact with floor. Base color is similar to HON Loft.

EDUCATION

HOW TO SPECIFY

Select
Model Number

Select
Seat Color

- BZ** Breeze
- S** Charcoal
- BL** Black

H E F S 0 1 .

B L



SmartLink® Student Desks, Seating, Storage, and Teacher Desk.

SMARTLINK®

Show of hands — who loves long lectures? Today's classroom is more hands-on and collaborative, involving group interactions that better stimulate learning. That's why we've done our homework in the design of SmartLink. This collection of lightweight and mobile desks, chairs, storage, and presentation tools earns high marks by being easy to arrange and rearrange, keeping active minds and bodies fully engaged.



FEATURES

- Put teachers in control of their storage, technology and environment.
- Worksurface shape supports creative configurations.
- Designed to the unique ways students sit and move throughout the day.
- Organize lesson plans and make the most of unused wall space.
- Move educational tools wherever the activities demand.
- SmartLink chairs warranted for users up to 300 lbs.

SMARTLINK® ORDERING INFORMATION

TEACHER DESK & MODULAR STORAGE

LAMINATES CODES

- L1
- ◆ Harvest CC
- ◆ Natural Maple DD
- ◆ Sheer Mesh A5
- ◆ Silver Mesh B9

PAINTS CODES

- P1
- ◆ Charcoal S
- P2
- ◆ Platinum Metallic T1

EDGE CODES

- ◆ Charcoal S
- ◆ Platinum K

STUDENT DESK

PLASTIC CODES

- ◆ Breeze G9
- ◆ Harvest CC
- ◆ Natural Maple DD
- ◆ Sand G8
- ◆ White G1

PAINTS CODES

- P1
- ◆ Charcoal S
- P2
- ◆ Platinum Metallic T1

VALUE MOBILE STORAGE

PAINTS CODES

- P1
- ◆ Black P
- ◆ Brownstone P7D
- ◆ Charcoal S
- ◆ Designer White PJW
- ◆ Fossil P28
- ◆ Greige T5
- ◆ Loft LOFT
- ◆ Muslin T3
- ◆ Shadow ☉ SHDW
- ◆ Titanium P8T

P2

- ◆ Champagne Metallic T4
- ◆ Platinum Metallic T1
- ◆ Silver PR6

P3

- ◆ Atom P8S
- ◆ Bullseye PJF
- ◆ Ember P8P
- ◆ Ion P8N
- ◆ Iris P8J
- ◆ Krypton P8F
- ◆ Regatta P8M

VALUE TEACHER DESK

LAMINATES CODES

- L1
- ◆ Black P
- ◆ Bourbon Cherry H
- ◆ Charcoal S
- ◆ Cognac COGN
- ◆ Designer White LDW1
- ◆ Florence Walnut LFW1
- ◆ Handspun Chestnut LAHC
- ◆ Handspun Dove LAHD
- ◆ Handspun Pearl LAHP
- ◆ Handspun Slate LAHS
- ◆ Harvest C
- ◆ Kingswood Walnut LK11
- ◆ Loft LOFT
- ◆ Mahogany N
- ◆ Mocha MOCH
- ◆ Natural Maple D
- ◆ Pinnacle PINC
- ◆ Shaker Cherry F
- ◆ Sheer Mesh ☉ A5
- ◆ Silver Mesh B9
- ◆ Steel Mesh ☉ A9
- ◆ Sterling Ash LSA1

L2

- ◆ Lowell Ash LLA1
- ◆ Natural Recon LNR1
- ◆ Phantom Ecru LPE1
- ◆ Portico Teak LPT1
- ◆ Skyline Walnut LSW1

PAINTS CODES

- P1
- ◆ Charcoal S
- ◆ Designer White PJW

P2

- ◆ Platinum Metallic T1
- ◆ Silver PR6

P3

- ◆ Atom P8S
- ◆ Bullseye PJF
- ◆ Ember P8P
- ◆ Ion P8N
- ◆ Iris P8J
- ◆ Krypton P8F
- ◆ Regatta P8M

EDGE CODES

- ◆ Atom AT
- ◆ Bullseye BY
- ◆ Charcoal S
- ◆ Ember MR
- ◆ Ion IO
- ◆ Iris IR
- ◆ Krypton KT
- ◆ Platinum K
- ◆ Regatta RE

VALUE STUDENT DESK

PLASTIC CODES

- ◆ Breeze G9
- ◆ Harvest CC
- ◆ Natural Maple DD
- ◆ Sand G8
- ◆ White G1

PAINTS CODES

- P1
- ◆ Charcoal S

P2

- ◆ Platinum Metallic T1

P3

- ◆ Atom P8S
- ◆ Bullseye PJF
- ◆ Ember P8P
- ◆ Ion P8N
- ◆ Iris P8J
- ◆ Krypton P8F
- ◆ Regatta P8M

UNIVERSAL MODESTY PANEL

PAINTS CODES

- P1
- ◆ Black P
- ◆ Brownstone P7D
- ◆ Charcoal S
- ◆ Designer White PJW
- ◆ Fossil P28
- ◆ Greige T5
- ◆ Light Gray Q
- ◆ Loft LOFT
- ◆ Muslin T3
- ◆ Putty L
- ◆ Shadow ☉ SHDW
- ◆ Textured Black Mica BLCK
- ◆ Textured Platinum Metallic PLAT
- ◆ Titanium P8T

P2

- ◆ Champagne Metallic T4
- ◆ Platinum Metallic T1
- ◆ Silver PR6
- ◆ Solar Black P8X
- ◆ Textured Silver PR8

P3

- ◆ Atom P8S
- ◆ Bullseye PJF
- ◆ Ember P8P
- ◆ Ion P8N
- ◆ Iris P8J
- ◆ Krypton P8F
- ◆ Regatta P8M

4-LEG, CANTILEVER CHAIR, TASK CHAIR, STOOL SHELLS

SHELL CODES

- ◆ Calypso CP
- ◆ Cherry CR
- ◆ Lava LA
- ◆ Lime LM
- ◆ Mulberry MB
- ◆ Onyx ON
- ◆ Platinum PT
- ◆ Regatta RE
- ◆ Shadow SD
- ◆ Surf BU
- ◆ Tangelo RG

4-LEG AND CANTILEVER CHAIR AND STOOL FRAME

PAINTS CODES

- P1
- ◆ Designer White Texture PK7
- ◆ Textured Charcoal P7A
- ◆ Textured Platinum Metallic PLAT

P2

- ◆ Silver Texture PR8

P3

- ◆ Atom P8S
- ◆ Bullseye PJF
- ◆ Ember P8P
- ◆ Ion P8N
- ◆ Iris P8J
- ◆ Krypton P8F
- ◆ Regatta P8M

P4

- ◆ Polished Chrome* Y

*\$52 upcharge. Polished Chrome not available on models HSS4L-06A, HSS4L-24B, and HSS4L-30B.

◆◆◆ For lead time information see page 17.

☉ De-emphasized





SMARTLINK® SPECIFYING INFORMATION

FINDING THE RIGHT FIT FOR YOUR STUDENT DESK & CHAIR

With the SmartLink® student desk's innovative shape, you can create dynamic learning environments and every space can be tailored to fit the lesson plan whether the need is for individual, student/group collaboration or teacher centered layouts. In addition to the desk's innovative top shape you can also select from three leg configurations to meet your specific needs for classroom or collaborative spaces.



STEP 1

Choose a grade range to find the recommended SmartLink® desk height.

| | | | |
|---|---|--|--|
|  <p>K-2nd Seated 22"-27" Standing 24"-30"</p> |  <p>3rd-5th Seated 23"-29" Standing 29"-35"</p> |  <p>6th-8th Seated 25"-30" Standing 32"-40"</p> |  <p>9th & Up Seated 29"-30" Standing 38"-43"</p> |
|---|---|--|--|

STEP 2

Pick the SmartLink® model that meets the student height needs.

| | |
|--|--|
|  <p>Model: HLD-M3A Adjustable Height 23"-33" Height Range</p> | <p>Use the color-coated circles in the chart on the right to find a compatible chair.</p> |
|  <p>Model: HLD-M3F Fixed Height 30" Fixed Height</p> | |
|  <p>Model: HLD-M3T Sit-to-Stand 30"-43" Height Range</p> | |

STEP 3

Determine the suggested chair height within your desk size range.

| Desk Height | Chair Seat Height | Type of Chair |
|-------------|-------------------|---------------------------|
| 22" | 12" | 4-Leg, Cantilever or Task |
| 23-24" | | |
| 25-27" | 14" | |
| 28-29" | 16-18" | |
| 30" | 18" | Stool |
| 31-33" | 22-24" | |
| 34-41" | 24-31" | |
| 42-43" | 30-32" | |

SMARTLINK® SPECIFYING INFORMATION

Individual Layouts

- The non-handed top allows the desk to be positioned to better support right-handed or left-handed individuals or be used in a forward position.



LH Position



Forward Position



RH Position

Group/Collaborative Layouts

Below are examples of how the student desks can be configured to support multiple students or group activities.

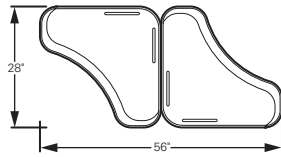

Student Desk
2-Desk Configuration

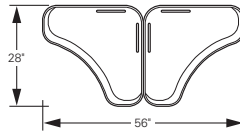

Opposing Student Desk
2-Desk Configuration

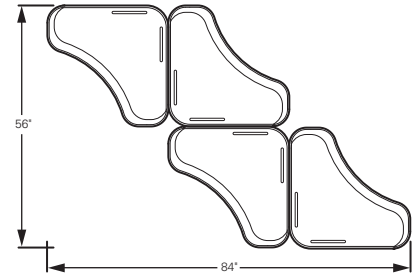

Student Desk
4-Desk Configuration

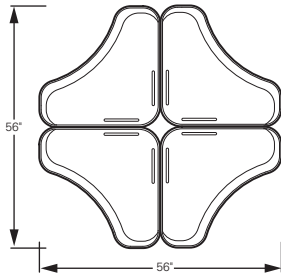

Student Desk
4-Desk Cluster Configuration

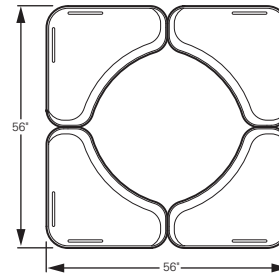

Student Desk
4-Desk Work Group Configuration
Can accommodate up to 8 students

Teacher Centered Layouts

- Reverse the layout and use the student desks to create layouts for teacher centers that can accommodate up to 6 students.
- 23 $\frac{5}{8}$ " distance between legs when used from either side.

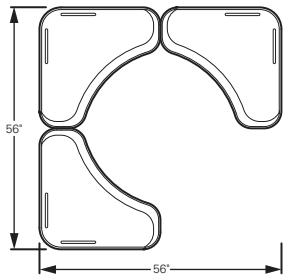

Teacher Centered Layout

Standard Row Layout

While a variety of classroom configurations are possible, a standard row layout shown below with 25 student desks utilizes a footprint of 199" deep by 284" wide. A 30 student desk row layout (5 rows deep by 6 rows wide) will require a footprint of 199" deep by 348" wide.

These dimensions are based upon 36"W aisles. Actual dimensions should be based upon local building codes.

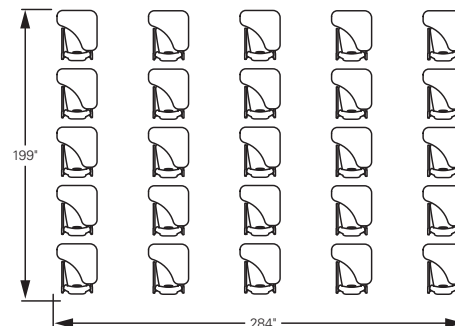

SMARTLINK® SPECIFYING INFORMATION

TEACHER STATION

SmartLink®

The following planning and specifying information is intended to help you imagine and create stimulating SmartLink classrooms that can integrate technology while helping rooms stay adaptable, organized and attractive. SmartLink offers you everything you need to create flexible, clutter-free learning environments for students of all ages.

Teacher Station – Standard Double Pedestal

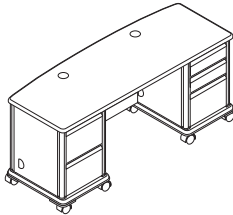

HLT2672-23.C

Storage

- Box/box/file pedestal is always standard on the right-hand side. Pedestal is locking.
- Available kneespace is 33¼" W x 20" D for all models.
- Non-locking Center Drawer (HD8X) may be field installed in the kneespace. Tops are pre-drilled to accept the drawer.
- Center drawers and CPU holders cannot be installed together.

Cable Management

- Both the left-hand and right-hand end panels may be removed to provide access to power and cable management within the side power cabinet.
- Grommets are standard in each removable end panel allow a power cord to exit and be plugged into a floor or wall outlet.
- Two "Smart Grommets" with a wireway cover are standard on each station's top surface.

Teacher Station – Standard Single Pedestal

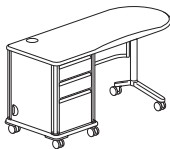

HLT2460-L3.C

Storage

- Single pedestal desk available in Left-hand or Right-hand pedestal/storage configurations.
- Pedestal options include Box/Box/File locking.

Cable Management

- The pedestals end panel may be removed to provide access to power and cable management within the side power cabinet.
- A grommet is standard in the removable end panel to allow a power cord to exit and be plugged into a floor or wall outlet.
- A single "Smart Grommet" with a wireway cover is standard on each station's top surface.

Teacher Station – Value Double Pedestal

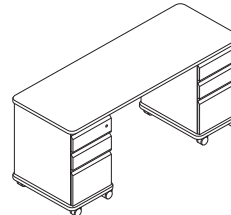

HLTV2466T-33

- Larger top size provides ample work/conference area or space for equipment.
- Standard with Heavy-duty 3", 360-degree swivel casters, 4-locking, 4-non-locking.
- Storage options include: Locking box/box/file.
- Kneewell space accommodates optional (specified separately) and field installed non-locking center drawer and CPU holders (see page 172).
- Modesty specified separately.
- Power modules can be ordered separately and mounted to the desk. See Power & Cable Management page 204.

Teacher Station – Value Single Pedestal

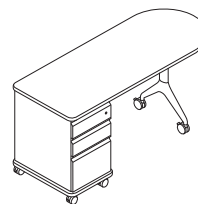

HLTV2460T-3

- Standard with Heavy-duty 3", 360-degree swivel casters, 4-locking, 4-non-locking.
- Storage options include: Locking box/box/file.
- Kneewell space accommodates optional (specified separately) and field installed non-locking center drawer and CPU holders (see page 172).
- Right or left assembled in the field.
- D-shape top encourages conferencing and provides ample work and conference area.
- Modesty specified separately.
- Power modules can be ordered separately and mounted to the desk. See Power & Cable Management page 204.

SMARTLINK® SPECIFYING INFORMATION

MODULAR STORAGE

SmartLink® Modular Storage is comprised of cases, accessories and support rails. However, only the cases and accessories need to be specified. The following guidelines should help you plan and specify SmartLink Storage.

Planning Notes

Cases

- A laminate top with a soft feel vinyl edge provides a classic look with exceptional durability.
- **Storage cases do NOT include accessories. Accessories are specified and sold separately.**
- Case configurations are based off of 12"W or 30"W columns.
- Internal case configurations cannot be changed (i.e., cannot change an HLSF52-3 to a HLSF52-21).
- Cases are designed to allow the users to create a variety of accessory configurations using different tray heights and shelves.
- Cases can be specified with or without locking doors.
- Door models may be converted to non-door models in the field.

Accessories

- Accessories include trays in 3", 6" and 12" heights, shelves in 12" and 30" widths and a 12"W coat rod.
- **All accessories are sold and specified separately as kits and include 1 pair of storage rails per tray or shelf.**
- The support rails simple "no tool" attachment method allows users to easily install and change rail (tray or shelf) positions as needed.
- Kits include:

| Accessory | Quantity Per Kit | Where Used |
|------------|-----------------------------|--------------------------------------|
| 3"H trays | 7 trays / 14 support rails | 12"W columns only |
| 6"H trays | 4 trays / 8 support rails | 12"W columns only |
| 12"H trays | 2 trays / 4 support rails | 12"W columns only |
| 12"W shelf | 2 shelves / 4 support rails | 12"W columns only |
| 30"W shelf | 2 shelves / 4 support rails | 30"W columns only |
| Coat Rod | 1 coat rod | 12"W columns — Full Height case only |

- Cabinet Whiteboard Bracket kit is available which allows whiteboards to be mounted to the back of the full height cabinets. Kit includes upper and lower rails with integrated marker tray and attachment hardware. Use wall rail sliding whiteboards. Rails will accept one (1) 48" x 48" board or two (2) 24" x 48" boards.

Specification Notes

- Number of accessory openings
- SmartLink storage cases are available in six (6) standard case types that feature combinations of 12" or 30" internal column widths. The following illustration shows the number of openings by column width for each case configuration.

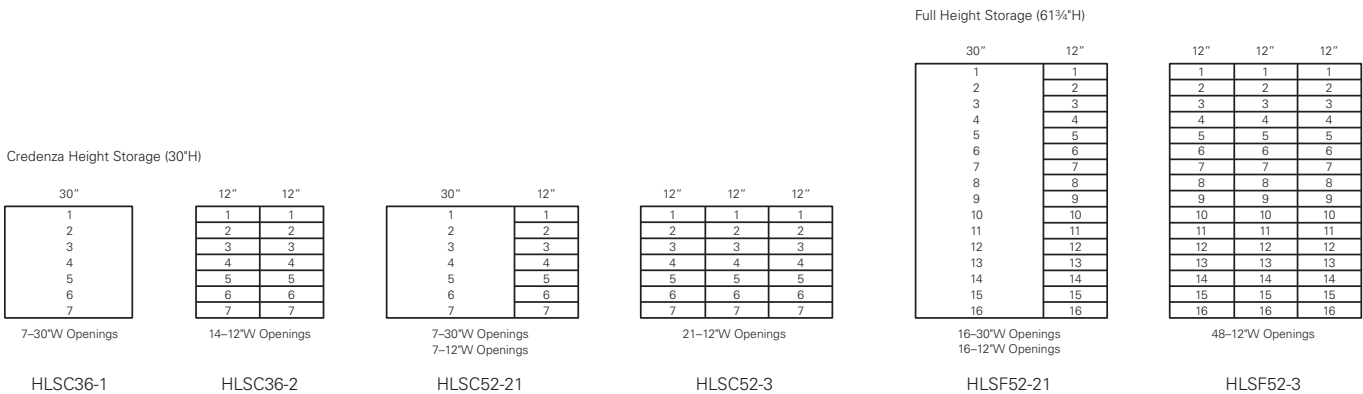

SMARTLINK® SPECIFYING INFORMATION

- Openings used by Accessory type:

| Accessory | Openings used per Accessory |
|------------|-----------------------------|
| 3”H tray | 1 |
| 6”H tray | 2 |
| 12”H tray | 4 |
| 12”W shelf | 1 |
| 30”W shelf | 1 |

- Any combination of trays or shelves (of common width) can be used as long as the openings used equal the total number of openings available per column. The following illustrations show a variety of tray configuration options. Numbers shown in the opening refers to the tray size.

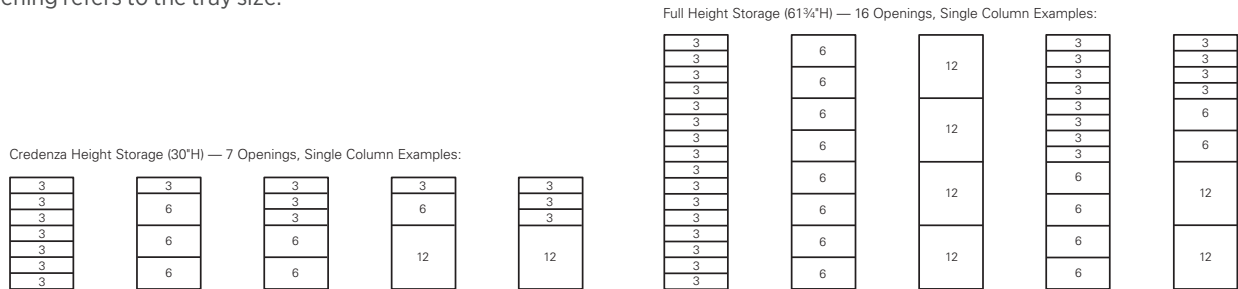

Using the information above, follow these guidelines to help determine accessory quantities.

1. Determine the total number of available “openings” by width (12”, 30”) for each case type.
Example: HLSF52T-3F has 3 columns of 16 openings, total 48 openings
2. On a PER COLUMN basis, determine the desired tray/shelf configurations total number of openings used so they equal the total openings available per column. Total accessory quantities per case then multiply by the total number of like cases.
Example: If each column will have 2-12” trays, 2-6” trays and 4-3” trays. The number of openings used for this column combination is 16. Assuming all three columns are the same total tray quantities for this case will be 12-3”, 6-6” and 6-12”.
3. Once total tray and shelf quantities are determined, simply divide by the kit quantity to determine the number of kits required.
Example: 3” trays = $12 \div 7 = 2$ kits, 6” trays = $6 \div 4 = 2$ kits, 12” trays = $6 \div 2 = 3$ kits

• Shelf Spacing

The clearance between shelves is approximately 3⅜” for every support rail that is not used between shelves. The following illustration shows the clearance between shelves when 0-4 support rail positions are not utilized.

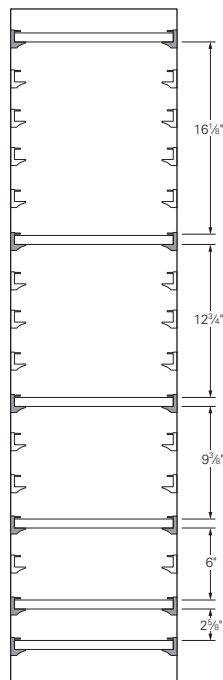

SMARTLINK® SPECIFYING INFORMATION

WALL RAIL SYSTEM

The SmartLink® wall rail is a multi-layered, multi-functional system that can accommodate a variety of presentation boards and accessories. The multiple tracks allow boards to be easily positioned and changed to support today's interactive learning environments.

Planning Notes

- Installation of the wall rail system over existing white or chalkboards is not recommended.
- The rail and wall bracket provide three separate tracks for the Learning boards. The REAR or wall/bracket track is occupied by the fixed wall board. The MIDDLE and FRONT tracks are for sliding boards.
- To allow for greater utilization of the rear fixed board a maximum width of 96" of sliding boards on the middle or front track is recommended.

The illustration below shows the overall wall space requirements for the rail system and recommended mounting height for use in K-12 classroom applications.

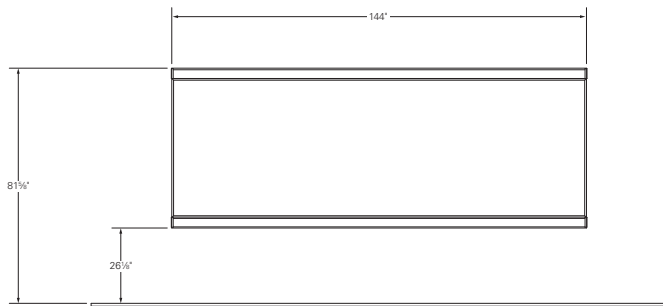

Sliding boards are removable and reversible so a wide variety of layouts are possible. The following illustrations highlight a couple of the more common applications. Layouts 2A and 2B provide the greatest amount of board space and overall flexibility. When used with rail mounted worksurfaces, use 24"W boards on the front rail as shown in 2C in front of each worksurface to provide information specific to that work area. Boards could then be added to the middle rail for information/work to be shared between the stations.

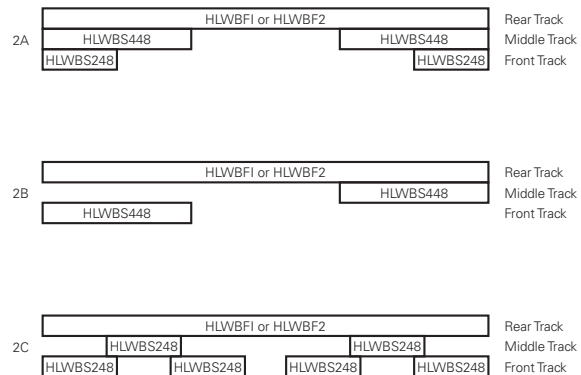







Specification Notes

- Boards are specified individually.
- Hardware to mount to the wall brackets is not provided by HON and **MUST BE SOURCED LOCALLY**.
- Learning board only applications require two (2) HLWR-12 rails to be specified.
- REFER TO PRODUCT INSTALLATION INSTRUCTIONS FOR DETAILED INSTALLATION INFORMATION.

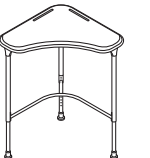

SMARTLINK® Student Desks



| | DESCRIPTION | MODEL | SHIP WEIGHT | CUBE | LIST PRICE |
|--|--|-----------------|--|------|---------------|
|  | Student Desk, Fixed Height 28"W x 28"W, User side 36¼"W 30" Fixed Height Hard Plastic Top Ships  Ships Assembled Ships Assembled with HLDA-15 Book Box attached | HLD-M3F | 63 | 5.5 | \$787 |
| | | HLD-M3FA | 58 | 17.9 | \$830 |
| | | HLD-M3FB | 65 | 17.9 | \$958 |
| | | | | | |
|  | Student Desk, Adjustable Height 28"W x 28"W, User side 36¼"W Adjustable: 23"-33" height adjustment range. Legs ship pre-set for 30" overall desk height when factory installed. Hard Plastic Top Ships  Ships Assembled Ships Assembled with HLDA-15 Book Box attached | HLD-M3A | 63  | 5.5 | \$787 |
| | | HLD-M3AA | 58 | 17.9 | \$830 |
| | | HLD-M3AB | 65 | 17.9 | \$958 |
| | | | | | |
|   | Student Desk, Sit-to-Stand 28"W x 28"W, User side 36¼"W Adjustable: 30"-43" height adjustment range. Leg height is set during field installation. Hard Plastic Top | HLD-M3T | 65 | 5.5 | \$1119 |
| | | | | | |

NOTES:

- Non-handed desk top constructed of ¾" hard plastic, includes dual pencil grooves.
- Hard plastic top features comfort edge on user side and soft radius with rounded corners on all sides.
- May also be specified to ship fully assembled, with or without HLDA-15 Book Box.
- Upper leg is painted, lower leg standard chrome finish on Adjustable and Sit-to-Stand models.
- Nylon swivel glides are standard on adjustable and fixed leg models.
- 29.60" distance between legs on user side. Outside distance between legs is 23⅜".
- Sit-to-Stand model features bell glides.
- Sit-to-Stand is height adjustable from 30"-43"H and includes a footrest.
- Accepts optional book box (HLDA-15) and backpack hooks (HCLA65).

SPECIFICATION TIP: Consider available kneespace when specifying under desk storage Wire Book Box. Available kneespace will vary significantly given set desk height. Use the following example to calculate the available and usable kneespace.

EXAMPLE: HLDV-M3A Student Desk, HLDA-15 Wire Book Box
 (user set desk height – top thickness – seat height = available kneespace)
 (29"H – 1" thickness – 18" seat height = 10" available kneespace)
 (available kneespace – book basket/box height = usable kneespace)
 (10" available kneespace – 5" basket height = 5" usable kneespace)

-  Field installed felt glide caps (HGDK3-F) are recommended for use on VCT flooring.
-  All Student Desks are ordered and shipped two (2) desks per carton. Legs and cross-brace ship unattached on  models. Pricing shown is per carton. Ordering two of model HLD-M3A or HLD-M3T will result in 2 cartons being shipped, giving you 4 desks.

HOW TO SPECIFY

| | | | |
|---|--|--|--|
| Select Model Number H L D - M 3 A | Select Glide Option E Hard-Surface (no upcharge) (Fixed or Adjustable models only) G Bell Glide (Sit-to-stand model only) | Select Top Color See page 156 G 9 | Select Upper Leg Color See page 156 S |
|---|--|--|--|

SMARTLINK® Value Series Student Desks

GSA SIN 33721T



Icon Legend on page 17

EDUCATION



DESCRIPTION

Student Desk, Fixed Height

28"W x 28"W, User side 36¼"W
30" Fixed Height

Hard Plastic Top

MODEL

HLDV-M3F

SHIP WEIGHT

63

CUBE

18.0

LIST PRICE BY PAINT GRADE

P1

\$643

P2

\$643

P3

\$673

NOTES: The cross-brace is installed to maximize kneespace but will not allow for book basket (HLDA-15) installation. The cross-brace orientation can be switched in the field to allow for book basket install.

🔧 Student Desks are ordered and shipped two (2) desks per carton. Legs and cross-brace ship attached. The cross-brace is installed to maximize kneespace but will not allow for book basket (HLDA-15) installation. Pricing shown is per carton. Ordering two of model HLDV-M3F will result in 2 cartons being shipped, giving you 4 desks.



Student Desk, Adjustable Height

28"W x 28"W, User side 36¼"W
Adjustable: 23"-33" height adjustment range.

Hard Plastic Top

HLDV-M3A

59

12.5

\$643

\$643

\$673

NOTES: Accepts book basket (HLDA-15) installation without repositioning crossbar.

🔧 Student Desks are ordered and shipped two (2) desks per carton. Upper leg and cross-brace ship attached. Lower adjustable legs ship unattached for field installation. Pricing shown is per carton. Ordering two of model HLDV-M3A will result in 2 cartons being shipped, giving you 4 desks.

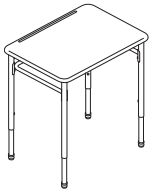

Rectangle Student Desk, Adjustable Height

20"W x 26"D
Adjustable: 23"-33" height adjustment range.

HLDV-MRECT2026A

57

9.19

\$643

\$643

\$673

NOTES: Accepts book basket (HLDA-15) installation without repositioning crossbar.

🔧 Student Desks are ordered and shipped two (2) desks per carton. Legs and cross-brace ship attached. Pricing shown is per carton. Ordering two of model HLDV-MRECT2026A will result in 2 cartons being shipped, giving you 4 desks.

NOTES:

- Upper leg is painted, lower leg standard chrome finish on Adjustable Height models.
- Non-handed desk top constructed of ¾" hard plastic.
- Hard plastic tops include pencil grooves.
- Nylon swivel glides are standard on adjustable and fixed leg models.
- Fixed Height models ship fully assembled. Adjustable models have the upper leg and cross-brace installed. The lower leg ships unattached for field installation.
- 29.60" distance between legs on user side. Outside distance between legs is 23¾".
- Accepts optional backpack hooks (HCLA65).
- Book boxes are only available as an accessory for field installation on Value Series desks.

SPECIFICATION TIP: Consider available kneespace when specifying under desk storage Wire Book Box. Available kneespace will vary significantly given set desk height. Use the following example to calculate the available and usable kneespace.

EXAMPLE: HLDV-M3A Student Desk, HLDA-15 Wire Book Box

(user set desk height – top thickness – seat height = available kneespace)

(29"H – 1" thickness – 18" seat height = 10" available kneespace)

(available kneespace – book basket/box height = usable kneespace)

(10" available kneespace – 5" basket height = 5" usable kneespace)

🔧 Field installed felt glide caps (HGDK3-F) are recommended for use on VCT flooring.







🔧 All Student Desks are ordered and shipped two (2) desks per carton. Ordering two of any model will result in 2 cartons being shipped, giving you 4 desks.

HOW TO SPECIFY

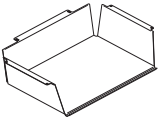
| | | | |
|--|--|---|---|
| <p>Select Model Number</p> <p>H L D V - M 3 F .</p> | <p>Select Glide Option</p> <p>E Hard-Surface (no upcharge)</p> <p>E .</p> | <p>Select Top Color</p> <p>See page 156</p> <p>G 9 .</p> | <p>Select Upper Leg Color</p> <p>See page 156</p> <p>S</p> |
|--|--|---|---|

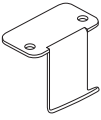

SMARTLINK® Student Accessories

| | DESCRIPTION | MODEL | SHIP WEIGHT | CUBE | LIST PRICE |
|--|---|-----------------|-------------|------|--------------|
|  SIN 33721T   | Metal Book Box (4 per Carton) 19½"W x 13"D x 5"H NOTES: Attaches to bottom of desk with 6 screws, included. Field installed. For use on model HLD-M3A, HLD-M3F, HLDV-MRECT2026A or HLD-M3T. Features integrated, full-width pencil holder. ⓘ Platinum finish only. | HLD A-15 | 15 | 2.0 | \$277 |
|  OPEN MARKET   | Back Pack Hook (10 per carton) NOTES: Assembly: attaches to bottom of desk with (2) screws, included. ⓘ Available in Platinum Metallic finish only, no specification needed. | HCLA65 | 10 | 0.1 | \$101 |
|  OPEN MARKET | Glide Kit — Felt Glide Caps <ul style="list-style-type: none"> • Recommended for use on VCT flooring. • Caps easily and securely snap over existing nylon swivel glide. • Kit includes 100 caps. • Field installed. ⓘ Not designed to be used with Sit-to-Stand Bell Glides (model HLD-M3T). Must be ordered with a configurable end product. If ordered separately, not on GSA Contract. | HGDK3-F | 2 | 0.2 | \$133 |

HOW TO SPECIFY

Select Model Number

H L D A - 1 5

| | MODEL/DESCRIPTION | DEPTH | WIDTH | HEIGHT | SHIP WEIGHT | CUBE | PER CARTON LIST |
|--|--|---|--------------------------------|--|-------------|------|---|
| | HSS4L-18B 18"H 4-Leg Chair, Armless | Maximum: 19 ⁵ / ₈ Seat: 16 ¹ / ₄ Back: 15 ³ / ₈ Seat to Floor: 18 Usable Seat Depth: 16 ¹ / ₈ | 19 ¹ / ₂ | 31 18 13 ³ / ₈ | 58 | 15.6 | P1 \$618 (reference single unit @ \$154.50) P2 \$618 (reference single unit @ \$154.50) P3 \$647 (reference single unit @ \$161.75) |
| | HSS4L-16B 16"H 4-Leg Chair, Armless | Maximum: 19 ⁵ / ₈ Seat: 16 ¹ / ₄ Back: 15 ³ / ₈ Seat to Floor: 16 Usable Seat Depth: 16 ¹ / ₈ | 19 ¹ / ₄ | 29 16 13 ³ / ₈ 16 | 54 | 15.6 | P1 \$618 (reference single unit @ \$154.50) P2 \$618 (reference single unit @ \$154.50) P3 \$647 (reference single unit @ \$161.75) |
| | HSS4L-14A 14"H 4-Leg Chair, Armless | Maximum: 17 Seat: 14 ¹ / ₄ Back: 13 ³ / ₈ Seat to Floor: 14 Usable Seat Depth: 14 | 17 | 25 ¹ / ₂ 14 11 ⁵ / ₈ 14 | 49 | 11.9 | P1 \$589 (reference single unit @ \$147.25) P2 \$589 (reference single unit @ \$147.25) P3 \$617 (reference single unit @ \$154.25) |
| | HSS4L-12A 12"H 4-Leg Chair, Armless | Maximum: 17 Seat: 14 ¹ / ₄ Back: 13 ³ / ₈ Seat to Floor: 14 Usable Seat Depth: 14 | 17 | 23 ¹ / ₂ 12 11 ⁵ / ₈ 12 | 45 | 11.9 | P1 \$589 (reference single unit @ \$147.25) P2 \$589 (reference single unit @ \$147.25) P3 \$617 (reference single unit @ \$154.25) |
| | HSS4L-06A 6"H 4-Leg Chair, Armless | Maximum: 17 Seat: 14 ¹ / ₄ Back: 13 ³ / ₈ Seat to Floor: 14 Usable Seat Depth: 14 | 17 | 17 ¹ / ₂ 6 11 ⁵ / ₈ 6 | 37 | 8.6 | P1 \$574 (reference single unit @ \$143.50) P2 \$574 (reference single unit @ \$143.50) P3 \$601 (reference single unit @ \$150.25) |

NOTES:





- High strength tubular steel frame.
- Seat Shell is one-piece injection molded.
- 16"H and 18"H models accept Wire Storage Basket model HSSA-WB1618.
- Casters are available on 16"H and 18"H chairs only.
- 4-Leg models stack 5-high on floor.
- Nylon or steel glides accept felt glide caps (HGDK3-F) which are recommended for use on VCT flooring.
- Durable textured powder coated paint finish or chrome option finish.

SmartLink® 4-Leg Chairs are ordered and shipped four (4) chairs per carton. Pricing shown is per carton. Each set of four chairs (one carton) must have the same shell/frame color combination. Ordering 2 of Model HSS4L-06A, HSS4L-12A, HSS4L-14A, HSS4L-16B or HSS4L-18B will result in 2 cartons being shipped, giving you 8 chairs.

HOW TO SPECIFY

| | | | |
|--|--|--|---|
| <p>Select Model Number</p> <p>HSS4L-12A</p> | <p>Select Glide Option</p> <p>E Nylon Glide N Nickel Steel Glide C Caster (\$196 upcharge)</p> <p>Caster option not available for models HSS4L-06A, HSS4L-12A or HSS4L-14A</p> <p>E</p> | <p>Select Shell Color</p> <p>See page 156</p> <p>RG</p> | <p>Select Frame Color</p> <p>See page 156</p> <p>P4 option Polished Chrome (Y) \$52 upcharge</p> <p>PLAT</p> |
|--|--|--|---|

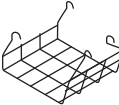



| | MODEL/DESCRIPTION | DEPTH | WIDTH | HEIGHT | SHIP WEIGHT | CUBE | LIST PRICE BY PAINT GRADE | | |
|--|--|-------|-------|--------|--------------------|--------------------|---------------------------|-------------------|-------|
| | | | | | | | P1 | P2 | P3 |
|  | HSS4L-24B 24"H 4-Leg Stool, Armless Maximum: Seat: Back: Seat to Floor: Usable Seat Depth: | 21½ | 22 | 38¼ | 30 | 16.8 | \$300 | \$300 | \$315 |
|  | HSS4L-30B 30"H 4-Leg Stool, Armless Maximum: Seat: Back: Seat to Floor: Usable Seat Depth: | 23½ | 22½ | 43¾ | 31 | 19.1 | \$316 | \$316 | \$331 |
|  | Wire Storage Basket (4 per carton) 15¾"W x 12¼"D x 9¾"H For 16" and 18" 4-Leg Chairs only. Chrome finish only, no specification needed. Chairs cannot be stacked when utilizing Wire Storage Basket. Not compatible with 4-Leg Stools or Cantilever Chairs. | | | | | | | | |
|  | Felt Cap Glide Kit for 4-Leg SmartLink® Recommended for use on VCT flooring. Caps easily and securely snap over the existing nylon swivel glide. Kit includes 100 caps for 25 chairs or desks. Field installed. Must be ordered with a configurable end product. If ordered separately, not on GSA Contract. | | | | | | | | |
| | DESCRIPTION | | | | MODEL | SHIP WEIGHT | CUBE | LIST PRICE | |
| | | | | | HSSA-WB1618 | 14 | 1.6 | \$149 | |
| | | | | | HGDK3-F | 2 | 0.2 | \$133 | |

NOTES:

- 4-Leg Stools may stack up to 5-high on floor.
- Lead times may vary by shell color.

HOW TO SPECIFY

| | | | |
|--|--|---|--|
| <p>Select Model Number</p> <p>H S S 4 L - 2 4 B</p> | <p>Select Glide Option</p> <p>E Nylon Glide N Nickel Steel Glide</p> <p>E</p> | <p>Select Shell Color</p> <p>See page 156</p> <p>R G</p> | <p>Select Frame Color</p> <p>See page 156 P4 option Chrome (Y) \$52 upcharge</p> <p>P L A T</p> |
|--|--|---|--|

| | MODEL/DESCRIPTION | DEPTH | WIDTH | HEIGHT | SHIP | | PER CARTON LIST |
|--|--|--|---------------------------------|-------------------|-------------------------|------------|---|
| | | | | | WEIGHT | CUBE | |
|  | HSSCL-18B 18"H Cantilever Base Chair, Armless | Maximum: Seat: Back: Seat to Floor: Usable Seat Depth: | 21¾ 16⅞ 16½ 15⅜ 16⅞ | 22¾ 16½ 15⅜ | 31¼ 18 13⅜ 18¼ | 80 23.7 | P1 \$897 (reference single unit @ \$224.25) P2 \$897 (reference single unit @ \$224.25) P3 \$939 (reference single unit @ \$234.75) |
|  | HSSCL-16B 16"H Cantilever Base Chair, Armless | Maximum: Seat: Back: Seat to Floor: Usable Seat Depth: | 21¾ 16⅞ 16½ 15⅜ 16⅞ | 22¾ 16½ 15⅜ | 29¼ 16 13⅜ 16¼ | 55 16.8 | P1 \$853 (reference single unit @ \$213.25) P2 \$853 (reference single unit @ \$213.25) P3 \$893 (reference single unit @ \$223.25) |
|  | HSSCL-14A 14"H Cantilever Base Chair, Armless | Maximum: Seat: Back: Seat to Floor: Usable Seat Depth: | 21¾ 16⅞ 16½ 15⅜ 16⅞ | 22¾ 16½ 15⅜ | 27¼ 14 13⅜ 14¼ | 52 16.8 | P1 \$837 (reference single unit @ \$209.25) P2 \$837 (reference single unit @ \$209.25) P3 \$876 (reference single unit @ \$219.00) |

NOTES:



- High strength tubular steel frame.
- Glides available with nylon or felt inserts. See ordering information below.
- Seat shell is one-piece injection molded.
- Cantilever models stack 5-high on floor.
- Durable textured powder coated paint or chrome option finish.

SmartLink® Cantilever Chairs are ordered and shipped four (4) chairs per carton. Pricing shown is per carton. Each set of four chairs (one carton) must have the same shell/frame color combination. Ordering 2 of Model HSSCL-18B will result in 2 cartons being shipped, giving you 8 chairs.

HOW TO SPECIFY

| | | | |
|--|---|---|---|
| <p>Select Model Number</p> <p>H S S C L - 1 8 B .</p> | <p>Select Glide Option</p> <p>E All-purpose Glide Insert (no upcharge) F Felt Glide Insert (\$36 list upcharge; \$9 per single unit see page 165)</p> <p>E .</p> | <p>Select Shell Color</p> <p>See page 156</p> <p>R G .</p> | <p>Select Frame Color</p> <p>See page 156 P4 option Polished Chrome (Y) \$52 upcharge</p> <p>P L A T</p> |
|--|---|---|---|

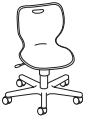

| | MODEL/DESCRIPTION | DEPTH | WIDTH | HEIGHT | SHIP WEIGHT | CUBE | PER CARTON LIST |
|---|--|--------------------------------|--------------------------------|--------------------------------|-------------|------|-----------------|
|  | HSSTK-18B 18"H Task Swivel Chair, Pneumatic Seat Height Adjustment | | | | 23 | 5.2 | \$337 |
| | Maximum: | 22 ⁵ / ₈ | 22 ¹ / ₂ | 34 ³ / ₄ | | | |
| | Seat: | 16 ¹ / ₄ | 16 ¹ / ₂ | 18 | | | |
| | Back: | | 15 ³ / ₈ | 13 ³ / ₈ | | | |
| | Seat to Floor: | | | 16-21 | | | |
|  | HSSST-18B 18"H Task Swivel Stool, Pneumatic Seat Height Adjustment, Footring Adjustment | | | | 28 | 12.8 | \$414 |
| Maximum: | 24 ¹ / ₄ | 25 ³ / ₄ | 45 ¹ / ₂ | | | | |
| Seat: | 16 ¹ / ₄ | 16 ¹ / ₂ | 18 | | | | |
| Back: | | 15 ³ / ₈ | 13 ³ / ₈ | | | | |
| Seat to Floor: | | | 22-32 | | | | |
| Usable Seat Depth: | 16 ³ / ₈ | | | | | | |

EDUCATION

NOTES:

- Seat Shell is one-piece injection molded.
 - Task Swivel Chair has a pneumatic seat height adjustment.
 - Choose between hard and soft casters (no upcharge) or bell glide (\$25 upcharge) options.
 - Stool has an adjustable footring.
 - Swivel Task Chair and Stool ship one per carton.
- !** Swivel Task Chair and Stool are available with a black frame only.

HOW TO SPECIFY

| | | |
|--|--|---|
| <p>Select Model Number</p> <p>H S S T K - 1 8 B</p> | <p>Select Glide Option</p> <p>S Soft Caster (no upcharge) H Hard Caster (no upcharge) G Bell Glide (\$25 upcharge)</p> <p>S</p> | <p>Select Shell Color</p> <p>See page 156</p> <p>R G</p> |
|--|--|---|

SMARTLINK® Teacher Stations

GSA SIN 33721T



Icon Legend on page 17

EDUCATION

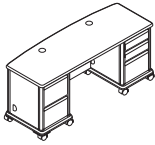

DESCRIPTION

Teacher Station
72"W x 26"D x 30"H
File/File Pedestal, Left
Box/Box/File Pedestal, Right

MODEL

HLT2672T-23

SHIP WEIGHT

254

CUBE

37.2

LIST PRICE

\$2342

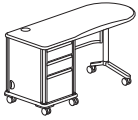

Teacher Station
60"W x 24"D x 30"H
Box/Box/File Storage, Single Pedestal, Right

HLT2460T-R3

136

29.3

\$2109

Teacher Station
60"W x 24"D x 30"H
Box/Box/File Storage, Single Pedestal, Left

HLT2460T-L3

136

29.3

\$2109

NOTES:

- Tops/Bases are Laminate with T-mold edge.
- Larger top size provides ample work/conference area or space for equipment.
- Standard with Heavy-duty 3", 360-degree swivel casters, 4-locking, 4-non-locking.
- Storage options include: Locking box/box/file and locking file/file.
- Kneewell space accommodates separately specified and field installed non-locking center drawer and CPU holders (see page 172).
- End panels are removable to access standard power management cabinets on both ends of the station for safe and secure storage of plug-strips, power cords and cables.
- Removable end panels have one outside cord management grommet.
- Full width cable management system provides easy access to and from each side cabinet.
- Standard with two Smart Grommets with wireway covers.
- Smart Grommets accept optional power inserts (see page 172).
- Single pedestal available in right and left handed configurations.
- D-shape top encourages conferencing and provides ample work and conference area.
- Standard with modesty panel.
- Modesty and column leg will match the specified metal surface color.

HOW TO SPECIFY

| | | | |
|---|---|---|---|
| Select Model Number H L T 2 6 7 2 T - 2 3 | Select Casters C Hard-Surface (no upcharge) | Select Top and Base Color B 9 Laminate See page 156 | Select T-Mold and Paint Color T 1 See page 156 |
|---|---|---|---|

DESCRIPTION

Accessory Rail (Side Mount)
21"W x 1/2"D x 1/2"H

MODEL

HLTA-TR24

SHIP WEIGHT

3 Ⓞ

CUBE

0.3

LIST PRICE

\$172

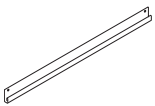

NOTES:

- Field installed.
- 21" Usable width.
- Specify paint.
- Mounts to either side of the Teacher Station or Storage Cases.
- Accepts file folder, Pencil holder, or other accessories (see page 177).

HOW TO SPECIFY



| | |
|---|--|
| Select Model Number H L T A - T R 2 4 | Select Frame Color S Charcoal T1 Platinum (\$12 upcharge) |
|---|--|



Icon Legend on page 17

SMARTLINK® Value Teacher Stations

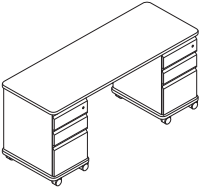
EDUCATION

| | DESCRIPTION | MODEL | SHIP WEIGHT | CUBE | LIST PRICE BY PAINT GRADE | | |
|--|---|---------------------|-------------|-------|---------------------------|--------|--------|
| | | | | | P1 | P2 | P3 |
|  | Value Teacher Station 66"W x 24"D x 30"H Box/Box/File Pedestal, Left Box/Box/File Pedestal, Right | HLTV2466T-33 | 240 | 21.1 | \$1926 | \$1958 | \$1980 |
|   | Value Teacher Station 60"W x 24"D x 30"H Box/Box/File Storage | HLTV2460T-3 | 158 | 14.18 | \$1465 | \$1491 | \$1508 |

NOTES:

- Tops/Bases are Laminate with T-mold edge.
- Standard with Heavy-duty 3", 360-degree swivel casters, 4-locking, 4-non-locking.
- Storage options include: Locking box/box/file.
- Kneewell space accommodates separately specified and field installed non-locking center drawer and CPU holders (see page 172).
- D-shape top encourages conferencing and provides ample work and conference area.
- Right or left assembled in the field.
- Modesty specified separately.
- Power modules can be ordered separately and mounted to the desk.

HOW TO SPECIFY

| | | | |
|----------------------------|--|--|---|
| Select Model Number | Select Top and Base Color Laminate See page 156 | Select T-Mold Color See page 156 | Select Paint Color See page 156 |
| H L T V 2 4 6 6 T - 3 3 . | B 9 . | K . | T 1 |

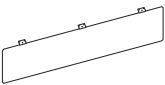
| | DESCRIPTION | MODEL | SHIP WEIGHT | CUBE | LIST PRICE BY PAINT GRADE | | |
|---|--------------------------------|------------------|-------------|------|---------------------------|-------|-------|
| | | | | | P1 | P2 | P3 |
|  | Universal Modesty Panel | HMTUMOD32 | 9 | 1.9 | \$232 | \$252 | \$262 |

SIN 33721

HOW TO SPECIFY

| | |
|----------------------------|---|
| Select Model Number | Select Paint Color See page 156 |
| H M T U M O D 3 2 . | S |

SMARTLINK® Teacher Station Accessories

GSA SIN 33721T EXCEPT AS NOTED



Icon Legend on page 17

EDUCATION



(Angled front)

DESCRIPTION

Metal Center Drawer, Non-Locking
24¾"W x 14¾"D x 3"H

| MODEL | SHIP WEIGHT | CUBE | LIST PRICE BY PAINT GRADE | |
|-------|-------------|------|---------------------------|-------|
| | | | P1 | P2 |
| HD8X | 12 Ⓞ | 1.2 | \$265 | \$275 |

NOTES: Not for use on 24" x 60" Teacher's Stations. Field installed. Non-locking. Minimum clearance for mounting: 27¾"W x 19¼"D. Specify paint. Available in Charcoal (S) or Platinum (T1) \$10 upcharge.

SPECIFYING EXAMPLE: HD8X.S

DESCRIPTION

360° Swivel CPU Holder with Adjustable Straps

- Supports CPUs 3¾" wide up to 64" perimeter and holds up to 75 lbs.
- 360° rotation.
- Ships complete and includes necessary mounting hardware and instruction sheet.

ⓘ Available in Black only, no specification needed.

| MODEL | SHIP WEIGHT | CUBE | LIST PRICE |
|-------|-------------|------|------------|
| HCPU1 | 7.0 Ⓞ | 0.2 | \$260 |

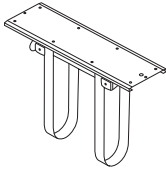

SIN 33721

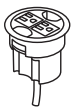

Power Hub, 3" Grommet Mount, 6' Cord

- Fits in 3" round grommet holes.
- Two grounded AC power outlets.
- Includes 6' cord with three-prong plug.
- Field installed with Plug-and-play ease.

NOTES: For additional information see page 204.

ⓘ Available in black only (no color designation so use .X - Specify: HGRMTAC.X).

| MODEL | SHIP WEIGHT | CUBE | LIST PRICE |
|---------|-------------|------|------------|
| HGRMTAC | 1.3 | 0.2 | \$126 |

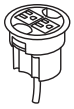

3" Round Power Grommet - 2 Outlets, 10' Cord

- Includes 10' cord with three-prong plug.
- Fits in 3" round grommet holes.
- Two grounded AC power outlets.
- Field installed with Plug-and-play ease.

ⓘ Available in black finish only, no specification needed.

| MODEL | SHIP WEIGHT | CUBE | LIST PRICE |
|----------|-------------|------|------------|
| HGRMTAC2 | 1.5 | 0.2 | \$159 |



Power/USB Hub, 3" Grommet Mount

- One grounded AC power outlet with 2 USB ports.
- Two cord pass-through holes in cap.
- Includes 6' cord with three-prong plug.
- Field installed; easy plug-and-play.
- UL Listed.

NOTES: For additional information see page 204.

ⓘ Available in black only (no color designation so use .X - Specify: HGRMTUSB2.X).

| MODEL | SHIP WEIGHT | CUBE | LIST PRICE |
|-----------|-------------|------|------------|
| HGRMTUSB2 | 1.3 Ⓞ | 0.2 | \$250 |

HOW TO SPECIFY

| Select Model Number | Select Paint |
|---------------------------|--|
| P Black | LOFT Loft |
| P7D Brownstone | T3 Muslin |
| PJW Designer White | L Putty |
| S Charcoal | SHDW Shadow ⓘ |
| P28 Fossil | P8T Titanium |
| T5 Greige | T4 Champagne Metallic (\$10 upcharge) |
| Q Light Grey | T1 Platinum Metallic (\$10 upcharge) |

HD8X.S

ⓘ De-emphasized

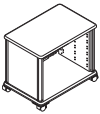
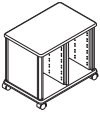
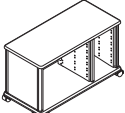
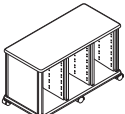
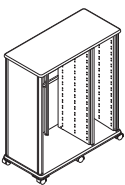
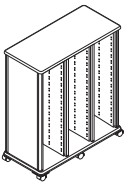

| | DESCRIPTION | MODEL | SHIP WEIGHT | CUBE | LIST PRICE |
|---|---|--------------------|-------------|------|---------------|
|  | Modular Storage Cabinet, Credenza Height 1 – 30"W Column 36 ³ / ₄ "W x 24 ¹ / ₄ "D x 30"H | HLSC36T-1N | 98 | 17.7 | \$1335 |
|  | Modular Storage Cabinet, Credenza Height 2 – 12"W Columns 36 ³ / ₄ "W x 24 ¹ / ₄ "D x 30"H | HLSC36T-2N | 103 | 17.7 | \$1460 |
|  | Modular Storage Cabinet, Credenza Height 1 – 30"W Left-hand Column 1 – 12"W Right-hand Column 52 ³ / ₄ "W x 24 ¹ / ₄ "D x 30"H | HLSC52T-21N | 154 | 25.3 | \$1716 |
|  | Modular Storage Cabinet, Credenza Height 3 – 12"W Columns 52 ³ / ₄ "W x 24 ¹ / ₄ "D x 30"H | HLSC52T-3N | 159 | 25.3 | \$1843 |
|  | Modular Storage Cabinet, Full Height 1 – 30"W Left-hand Column 1 – 12"W Right-hand Column 52 ³ / ₄ "W x 24 ¹ / ₄ "D x 61 ³ / ₄ "H | HLSF52T-21N | 254 | 51.4 | \$2326 |
|  | Modular Storage Cabinet, Full Height 3 – 12"W Columns 52 ³ / ₄ "W x 24 ¹ / ₄ "D x 61 ³ / ₄ "H | HLSF52T-3N | 164 | 51.4 | \$2576 |

NOTES:

- Cases will accept a variety of storage accessories including trays, shelves, and coat rods. Refer to pages 160-161 for capacity specification/planning guidelines by cabinet size.
- Specify trays, shelves, or coat rod accessories separately, see page 175.
- Standard with Heavy-duty 3", 360-degree swivel casters, 36" with case includes four casters (2-locking, 2-non-locking), 52"W cases include six casters (3-locking, 3-non-locking).

HOW TO SPECIFY

| | | | |
|---|--|---|--|
| Select Model Number HLSC36T-1N | Select Casters C Hard-Surface (no upcharge) | Select Top and Base Color Laminate See page 156 | Select T-Mold and Paint Color See page 156 |
| H L S C 3 6 T - 1 N | C | D D | T 1 |

SMARTLINK® Modular Storage

GSA SIN 33721T



Icon Legend on page 17

EDUCATION

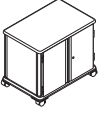
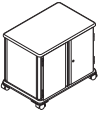
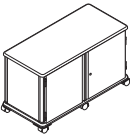
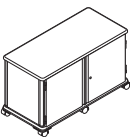
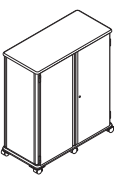
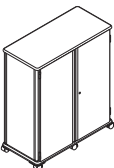
| | DESCRIPTION | MODEL | SHIP WEIGHT | CUBE | LIST PRICE |
|--|---|--------------------|-------------|------|---------------|
|  | Modular Storage Cabinet, Credenza Height 1 – 30" W Column 36¾" W x 24¼" D x 30" H | HLSC36T-1D | 114 | 17.7 | \$1510 |
|  | Modular Storage Cabinet, Credenza Height 2 – 12" W Columns 36¾" W x 24¼" D x 30" H | HLSC36T-2D | 119 | 17.7 | \$1630 |
|  | Modular Storage Cabinet, Credenza Height 1 – 30" W Left-hand Column 1 – 12" W Right-hand Column 52¾" W x 24¼" D x 30" H | HLSC52T-21D | 174 | 25.3 | \$1845 |
|  | Modular Storage Cabinet, Credenza Height 3 – 12" W Columns 52¾" W x 24¼" D x 30" H | HLSC52T-3D | 179 | 25.3 | \$1964 |
|  | Modular Storage Cabinet, Full Height 1 – 30" W Left-hand Column 1 – 12" W Right-hand Column 52¾" W x 24¼" D x 61¾" H | HLSF52T-21D | 286 | 51.4 | \$2489 |
|  | Modular Storage Cabinet, Full Height 3 – 12" W Columns 52¾" W x 24¼" D x 61¾" H | HLSF52T-3D | 296 | 51.4 | \$2719 |

NOTES:

- Cases will accept a variety of storage accessories including trays, shelves, and coat rods. Refer to pages 160-161 for capacity specification/planning guidelines by cabinet size.
- Specify trays, shelves, or coat rod accessories separately, see page 175.
- Standard with Heavy-duty 3", 360-degree swivel casters, 36" with case includes four casters (2-locking, 2-non-locking), 52" W cases include six casters (3-locking, 3-non-locking).

HOW TO SPECIFY

| | | | |
|---|---|---|---|
| <p>Select Model Number</p> <p>HLSC36T-1D</p> | <p>Select Casters</p> <p>C Hard-Surface (no upcharge)</p> <p>C</p> | <p>Select Top and Base Color</p> <p>Laminate</p> <p>See page 156</p> <p>DD</p> | <p>Select T-Mold and Paint Color</p> <p>See page 156</p> <p>T1</p> |
|---|---|---|---|



SMARTLINK® Modular Storage and Accessories

| | DESCRIPTION | MODEL | SHIP WEIGHT | CUBE | LIST PRICE |
|--|--|--|--------------|------------|------------------------------|
| | Tray Kits | | | | |
| | 3"H x 12"W, 7 trays and 14 rails per kit | HLSA-TK3 | 12.0 | 2.7 | \$209 |
| | 6"H x 12"W, 4 trays and 8 rails per kit | HLSA-TK6 | 10.0 | 2.7 | \$145 |
| | 12"H x 12"W, 2 trays and 4 rails per kit | HLSA-TK12 | 7.0 | 2.7 | \$109 |
| | NOTES: Field installed. See pages 160-161 for specifying guidelines. Semi-translucent white SPECIFYING EXAMPLE: HLSA-TK3.X | | | | |
| | Shelf Kits, 2 shelves and 4 rails per kit | | | | |
| | 12"W x 24"D 30"W x 24"D | HLSA-SK1220T HLSA-SK3020T | 14.0 28.0 | 0.6 1.2 | \$312 \$453 |
| | NOTES: Field installed. See pages 160-161 for specifying guidelines. Specify color. | | | | |
| | Coat Rod, Single Unit 12"W x 1" diameter | HLSA-CR12 | 0.5 | 0.1 | \$109 |
| | NOTES: Use with Full-height cases, 12" columns only. Field installed. Anodized finish only. | | | | |
| | Hanging Folder Rail Kit 12"W Rails 4 rails per kit, each tray uses 2 rails | HLSA-HRK | 0.5 | 0.2 | \$44 |
| | NOTES: Use with 12" trays only. Field installed. Anodized finish only. | | | | |
| | Cabinet Whiteboard Mounting Bracket 52"W Includes 1 pair (upper and lower) of rails and mounting hardware. | HLSA-WBK52 | 5.0 | 0.3 | \$192 |
| | <ul style="list-style-type: none"> Accommodates: 1 – 48" x 48" Sliding Board or 2 – 24" x 48" Sliding Boards Compatible Sliding Boards (see page 176) HLWBS-448WW HLWBS-248WW HLWBS-448WT HLWBS-248WT Requires field installation. NOTES: For use on full-height cabinets only. Rails feature an integrated marker tray. Specify Charcoal (S) or Platinum (T1) color. SPECIFYING EXAMPLE: HLSA-WBK52.S | | | | |

NOTES:

- Mounting bracket model HLSA-WBK52 mounts whiteboard to back of full-height Modular Storage unit.
- For use in Modular Storage cases.
- Trays for use in 12" width columns only. Shelves are available for use in 12" and 30" width columns.
- Trays and shelves hang off a pair of accessory rails.
- Trays and shelves are sold in "kit quantities" and include necessary accessory rails for installation.
- 12" trays accept rails to accommodate hanging file folders (side-to-side).
- All accessories are field installed.
- Trays feature front and rear handles for easy handling and are semi-translucent white for visibility to contents.
- All shelves feature an integrated finger pull and safety mechanism to prevent accidental removal.
- See pages 160-161 for specifying details.

HOW TO SPECIFY

| | |
|---|--|
| Select Model Number <div style="border: 1px solid black; padding: 2px; display: flex; gap: 5px;"> HLSA-SK1220T </div> | Select Shelf Color C Harvest D Natural Maple LDW1 Designer White LOFT Loft <div style="border: 1px solid black; padding: 2px; display: inline-block; width: 20px; height: 20px; text-align: center; vertical-align: middle;">C</div> |
|---|--|

SMARTLINK® Wall Rail System

GSA SIN 3372IT



Icon Legend on page 17

EDUCATION

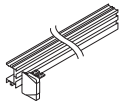

| DESCRIPTION | MODEL | SHIP WEIGHT | CUBE | LIST PRICE |
|--------------------------|----------------|-------------|------|--------------|
| Wall Rail 144" | HLWR-12 | 22 | 1.4 | \$827 |

NOTES: Rail model includes: 1 – 144” rail, 9 – wall mounting brackets and 2 – rail end caps.

- ❗ Must be mounted in accordance with published installation instructions. Wall mounting hardware NOT INCLUDED. Must be sourced locally.
- ❗ Must order Quantity 2 rails when using with Whiteboards and Whiteboards/Tackboards.
- ❗ Platinum finish only.

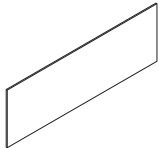

| | | | | |
|--|---------------------|-----|------|---------------|
| Learning Board, Fixed Whiteboard, 1-sided 144”W x 48”H, Quantity 1 | HLWBF1-1248W | 124 | 13.0 | \$1978 |
|--|---------------------|-----|------|---------------|

SPECIFYING EXAMPLE: HLWBF-1248W.X

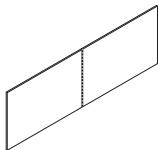

| | | | | |
|---|---------------------|-----|-----|---------------|
| Learning Board, Fixed Whiteboards, 1-sided 72”W x 48”H, Quantity 2 with spacer (included) | HLWBF2-1248W | 125 | 6.7 | \$1978 |
|---|---------------------|-----|-----|---------------|

NOTES: Includes center cover/spacer.
SPECIFYING EXAMPLE: HLWBF2-1248W.X

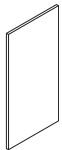

| | | | | |
|---|--------------------|----|-----|--------------|
| Learning Board, Sliding Whiteboard/Whiteboard 48”W x 48”H | HLWBS-448WW | 47 | 4.6 | \$954 |
| 24”W x 48”H | HLWBS-248WW | 26 | 2.5 | \$610 |

NOTES: May be used with HLSA-WBK52 to mount to the back of full-height Mobile Cabinets. (See page 175.)

SPECIFYING EXAMPLE: HLWBS-448WW.X

Model HLWBS-248WW shown

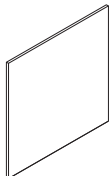

| | | | | |
|--|--------------------|----|-----|--------------|
| Learning Board, Sliding Whiteboard/Tackboard 48”W x 48”H | HLWBS-448WT | 64 | 4.6 | \$993 |
| 24”W x 48”H | HLWBS-248WT | 34 | 2.5 | \$636 |

NOTES: May be used with HLSA-WBK52 to mount to the back of full-height Mobile Cabinets. (See page 175.)
Tackboard Side available in the following fabric: Lucy Neutra (LC24).

SPECIFYING EXAMPLE: HLWBS-448WT.X.LC24

Model HLWBS-448WT shown

NOTES:





- Multi-functional wall rails can accommodate whiteboards and organizational accessories. See above and page 177.
- Sliding learning boards may be attached to the back of Mobile, full-height cabinets with bracket kit HLSA-WBK52 (see page 175).
- Multi-track rail allows for up to three layers of whiteboards. Rear track supports a fixed board, middle and front tracks support sliding boards. Outer rail channel is for attachment of organizational accessories.
- Sliding learning boards are removable and reversible.
- All fixed and sliding boards:
 - Require two (upper and lower) rails for installation.
 - Feature a full aluminum frame.
 - Are high-quality porcelain over steel and non-shadowing.
 - Are low gloss for projection use and allows for use of magnets.

HOW TO SPECIFY

| | | |
|--|---|---|
| <p>Select Model Number</p> <p>HLWBS - 448WT .</p> | <p>Select Side A Color</p> <p>X Whiteboard</p> | <p>Select Tackboard Fabric</p> <p>LC24 Lucy Neutra Specify for models HLWBS-448WT and HLWBS-248WT only</p> |
|--|---|---|



SMARTLINK® Wall Rail System Accessories

| | DESCRIPTION | MODEL | SHIP WEIGHT | CUBE | LIST PRICE BY PAINT GRADE | | |
|---|--|---------------|-------------|------|---------------------------|-------|-------|
| | | | | | P1 | P2 | P3 |
|  | Marker Tray (Single Pack) 7"W x 3½"D x 2"H NOTES: Holds dry-erase markers, push pins and other small objects. | HPPMMT | 1 | 0.2 | \$95 | \$107 | \$118 |
|  | Paper Clip (2 per carton) 5"W x 2"H NOTES: Use individually for artwork or smaller items. Use in pairs for larger notepad size pieces of paper. | HPPMPC | 1 | 0.2 | \$103 | \$115 | \$126 |
|  | All-Purpose Hook (10 per carton) NOTES: Use for hanging back-packs, coats and other items. Hooks slide horizontally and cannot be removed without first removing the rail end cap. ! Specify paint — Platinum Metallic only. | HPPMHK | 1 | 0.2 | N/A | \$231 | N/A |
|  SIN 33721 | CD/Pencil Holder 5¼"W x 1½"D x 5"H NOTES: Installs on the Wall Rail or Accessory Rail (HLTA-TR24) for use on the Teacher's Desk or Storage Cases. May also be mounted on Folder Bins. | HPPMPB | 1 | 0.2 | \$114 | \$126 | \$137 |
|  SIN 33721 | Folder Bin 12¼"W x 1¼"D x 9"H NOTES: Installs on the Wall Rail or Accessory Rail (HLTA-TR24) for use on the Teacher's Desk or Storage Cases. Folder Bin may be mounted (stacked) to each other. | HPPMFB | 2 | 0.3 | \$114 | \$126 | \$137 |

NOTES:

- Accessories above to be used on the Wall Rail System — see page 176.
- All accessories mount on the rail's outer channel and may be used with sliding boards.
- All accessories may be mounted and moved to any position along the width of the rail.
- All accessories may be easily removed from the rail with the exception of the All-Purpose Hook. All-Purpose Hook can slide horizontally along the rail but cannot be removed without removing a rail end cap.

HOW TO SPECIFY

| | |
|----------------------------|--|
| Select Model Number | Select Paint Color |
| | See page 156 Model HPPMHK available in Platinum Metallic only |
| H P P M M T . | T 1 |

SMARTLINK® Value Mobile Storage

GSA SIN 33721 EXCEPT AS NOTED



Icon Legend on page 17

EDUCATION

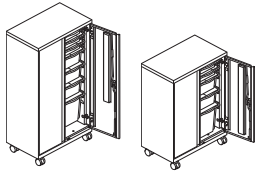

HLVMSC5630R HLVMSC4330R

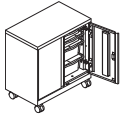

HLVMSC3330R

DESCRIPTION

Mobile Storage Cabinet with Bins

18"D x 30"W x 32¼"H
18"D x 30"W x 42¼"H
18"D x 30"W x 56"H

MODEL

HLVMSC3330R
HLVMSC4330R Ⓢ
HLVMSC5630R

SHIP WEIGHT

152.6
171.6
209.6

CUBE

13.4
18.0
23.5

LIST PRICE BY PAINT GRADE

P1 P2 P3

\$1540 \$1584 \$1613
\$1693 \$1741 \$1773
\$1948 \$2003 \$2040

OPEN MARKET

NOTES:

- Full radius "R" handle on doors.
- Units include 2 locking and 2 non-locking casters.
- Equipped with HON "One Key" interchangeable core removable locks.

ⓘ Pre-configured trays and rails included in mobile storage cabinets with bins. See chart below for configurations and capacity. Additional bin and rail kits may be purchased separately.

DESCRIPTION

Accessories — Tray Kit

3"H, 2 bins and 4 rails
6"H, 2 bins and 4 rails
12"H, 2 bins and 4 rails

MODEL

HFMBIN3
HFMBIN6
HFMBIN12

SHIP WEIGHT

7 Ⓢ
10 Ⓢ
12 Ⓢ

CUBE

4.0
4.5
5.0

LIST PRICE

\$59
\$72
\$84

NOTES: Value mobile storage cabinets ship with pre-determined rails and bins. Additional bins and rails may be ordered in sets of two utilizing the models shown. Availability and usage are outlined below.

ⓘ Semi-translucent white.

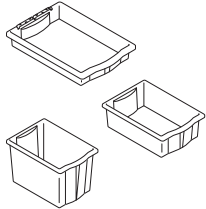

Pre-Configured Cabinets/Tray Kits

56"H Cabinet

| | |
|---|---|
| 1 | 2 |
| 3 | 4 |
| 5 | 6 |
| 1 | 2 |
| 3 | 4 |
| 5 | 6 |
| 1 | 2 |

42¼"H Cabinet

| | |
|---|---|
| 1 | 2 |
| 3 | 4 |
| 1 | 2 |
| 3 | 4 |
| 1 | 2 |

32¼"H Cabinet

| | |
|---|---|
| 1 | 2 |
| 3 | 4 |
| 1 | 2 |
| 3 | 4 |

56"H Cabinet

| | |
|----|----|
| 1 | 14 |
| 2 | 15 |
| 3 | 16 |
| 4 | 17 |
| 5 | 18 |
| 6 | 19 |
| 7 | 20 |
| 8 | 21 |
| 9 | 22 |
| 10 | 23 |
| 11 | 24 |
| 12 | 25 |
| 13 | 26 |

42¼"H Cabinet

| | |
|----|----|
| 1 | 11 |
| 2 | 12 |
| 3 | 13 |
| 4 | 14 |
| 5 | 15 |
| 6 | 16 |
| 7 | 17 |
| 8 | 18 |
| 9 | 19 |
| 10 | 20 |

32¼"H Cabinet

| | |
|---|----|
| 1 | 7 |
| 2 | 8 |
| 3 | 9 |
| 4 | 10 |
| 5 | 11 |
| 6 | 12 |

Hanging Slots 12"H Bin 6"H Bin 3"H Bin

| | | | |
|---|--|--|--|
| 1 | | | |
| 2 | | | |
| 3 | | | |
| 4 | | | |

26 - 12"W Openings

20 - 12"W Openings

12 - 12"W Openings

HOW TO SPECIFY

Select Model Number

HLVMSC3330R

Select Lock Option

- L Lock (no upcharge)
- X Omit Lock (deduct \$20)

L

Select Paint Color

See page 156

PJW



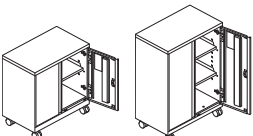
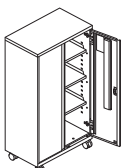

Icon Legend on page 17

SMARTLINK® Value Mobile Storage

| | DESCRIPTION | MODEL | SHIP WEIGHT | CUBE | LIST PRICE BY PAINT GRADE | | |
|---|--|---|-------------------------|----------------------|---|---|---|
| | | | | | P1 | P2 | P3 |
|  HLVSC3330R HLVSC4330R | Mobile Storage Cabinet without Bins 18"D x 30"W x 32¼"H 18"D x 30"W x 42¼"H 18"D x 30"W x 56"H | HLVSC3330R HLVSC4330R HLVSC5630R | 152.6 171.6 209.6 | 13.4 18.0 23.5 | \$1401 \$1540 \$1847 | \$1441 \$1584 \$1899 | \$1467 \$1613 \$1934 |
| |  HLVSC5630R | | | | | | |

NOTES:

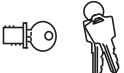
- Full radius "R" handle on doors.
- Units include 2 locking and 2 non-locking casters.
- Includes shelves which are adjustable in 2" increments.
- Equipped with HON "One Key" interchangeable core removable locks.
- Wire management grommet in back of unit.

| | DESCRIPTION | MODEL | SHIP WEIGHT | CUBE | LIST PRICE |
|--|---|--------------|---|------|-------------|
|  SIN 33721 | Chrome Removable Lock Core Kit (for metal casegoods) • Use when specifying omit lock application. • Specify quantity of each key number from 101E-225E. • Includes: 1-core, 2-keys, 1-core removal tool and instructions. • Removable lock core kits with specific key number must be ordered to facilitate keying alike in the field. • For specific models, look for the Omit Lock Core icon throughout this publication. | HF23C | 0.1  | 0.1 | \$49 |
| | NOTES: If key number isn't specified, number will be at random. Core matches manufactured lock on metal casegoods product but can be used with Contain® and laminate product. | | | | |

HOW TO SPECIFY

| | | |
|---|--|---|
| <p>Select Model Number</p> <p>HLVSC3330R</p> | <p>Select Lock Option</p> <p>L Lock (no upcharge) X Omit Lock (deduct \$20)</p> <p>L</p> | <p>Select Paint Color</p> <p>See page 156</p> <p>PJW</p> |
|---|--|---|

EDUCATION

SMARTLINK® Value Mobile Storage

OPEN MARKET



Icon Legend on page 17

EDUCATION

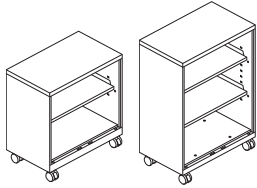

HLVBC3330

HLVBC4330

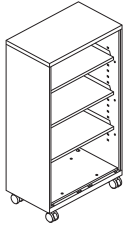

HLVBC5630

DESCRIPTION

Mobile Bookcases

18"D x 30"W x 31¼"H

18"D x 30"W x 42¼"H

18"D x 30"W x 56"H

| MODEL | SHIP WEIGHT | CUBE | LIST PRICE BY PAINT GRADE | | |
|-----------|-------------|------|---------------------------|--------|--------|
| | | | P1 | P2 | P3 |
| HLVBC3330 | 118.6 | 13.4 | \$1272 | \$1308 | \$1332 |
| HLVBC4330 | 134.6 | 18.0 | \$1401 | \$1441 | \$1467 |
| HLVBC5630 | 157.6 | 23.5 | \$1680 | \$1728 | \$1759 |

NOTES:

- Units include 2 locking and 2 non-locking casters.
- Shelves adjust in 2" increments.
- Wire management grommet in back of unit.

HOW TO SPECIFY

Select Model Number

Select Paint Color

See page 156

HLVBC3330

PJW

WORKPLACE TOOLS



Flock® Modular Seating with Dean Power Module Under-Surface Mount.

WORKPLACE TOOLS

Workplace tools provide the finishing touch on any high-performance workspace. From storage options to technological tools and lighting solutions, HON's Workplace Tools deliver organization and efficiency to the office. Workplace Tools put everything you need to be productive within arm's reach, provide easy access to the connectivity you need to be successful and help you keep your workspace neat.



PRODUCT CATEGORIES

- Monitor Arms
- Keyboard Trays and Center Drawers
- Paper Management and Organizational Tools
- Task Lights
- Electrical and Power Management Accessories
- Ergonomic and Healthy Workplace Solutions

WORKPLACE TOOLS ORDERING INFORMATION

LAMINATE CENTER DRAWERS, LAMINATE PAPER MANAGEMENT MODELS HLVP1/HLDST1/ HLSL1472LS/HLSL1460LS

L1 LAMINATES CODES

Woodgrain

- ◆ Bourbon Cherry H
- ◆ Cognac COGN
- ◆ Florence Walnut LFW1
- ◆ Harvest C
- ◆ Kingswood Walnut LK11
- ◆ Mahogany N
- ◆ Mocha MOCH
- ◆ Natural Maple D
- ◆ Pinnacle PINC
- ◆ Shaker Cherry F
- ◆ Sterling Ash LSA1

Solid

- ◆ Black P
- ◆ Charcoal S
- ◆ Designer White LDW1
- ◆ Loft LOFT

L2 LAMINATES CODES

Woodgrain

- ◆ Lowell Ash LLA1
- ◆ Natural Recon LNR1
- ◆ Phantom Ecru LPE1
- ◆ Portico Teak LPT1
- ◆ Skyline Walnut LSW1

LAMINATE KEYBOARD PLATFORM MODELS H4022/HE4022

L1 LAMINATES CODES

Woodgrain

- ◆ Bourbon Cherry H
- ◆ Cognac COGN
- ◆ Florence Walnut LFW1
- ◆ Harvest C
- ◆ Kingswood Walnut LK11
- ◆ Mahogany N
- ◆ Mocha MOCH
- ◆ Natural Maple D
- ◆ Pinnacle PINC
- ◆ Shaker Cherry F
- ◆ Sterling Ash LSA1

Solid

- ◆ Black P
- ◆ Charcoal S
- ◆ Designer White LDW1
- ◆ Whitestone K4

Patterned

- ◆ Handspun Chestnut LAHC
- ◆ Handspun Dove LAHD
- ◆ Handspun Pearl LAHP
- ◆ Handspun Slate LAHS
- ◆ Sheer Mesh * A5
- ◆ Silver Mesh B9
- ◆ Steel Mesh * A9
- ◆ Canyon Zephyr * K9
- ◆ Desert Zephyr * K8
- ◆ Shadow Zephyr * K1
- ◆ Gray G2
- ◆ Grey Tigris * L6
- ◆ White G1

L2 LAMINATES CODES

Woodgrain

- ◆ Lowell Ash LLA1
- ◆ Natural Recon LNR1
- ◆ Phantom Ecru LPE1
- ◆ Portico Teak LPT1
- ◆ Skyline Walnut LSW1

METAL PAPER MANAGEMENT MODELS HHPS1 AND HDPS1

PAINT CODES

P1

- ◆ Black P
- ◆ Brownstone P7D
- ◆ Charcoal S
- ◆ Designer White PJW
- ◆ Fossil P28
- ◆ Greige T5
- ◆ Light Gray Q
- ◆ Loft LOFT
- ◆ Muslin T3
- ◆ Putty L
- ◆ Shadow * SHDW
- ◆ Titanium P8T

P2

- ◆ Champagne Metallic T4
- ◆ Platinum Metallic T1
- ◆ Silver PR6

P3

- ◆ Amethyst P091
- ◆ Atom P8S
- ◆ Blossom P8K
- ◆ Bullseye PJF
- ◆ Cabernet * P7T
- ◆ Cobalt Mica P090
- ◆ Conifer * P8H
- ◆ Ember P8P
- ◆ Ion P8N
- ◆ Iris P8J
- ◆ Krypton P8F
- ◆ Ochre P093
- ◆ Regatta P8M
- ◆ Sienna P092
- ◆ Succulent P8A

METAL CENTER DRAWERS*, CORNER SLEEVES, METAL KEYBOARD PLATFORM, STORAGE CUBES, DRAWER ORGANIZER, HAND SANITIZER STATION

PAINT CODES

P1

- ◆ Black P
- ◆ Brownstone P7D
- ◆ Charcoal S
- ◆ Designer White PJW
- ◆ Fossil P28
- ◆ Greige T5
- ◆ Light Gray Q
- ◆ Loft LOFT
- ◆ Muslin T3
- ◆ Putty L
- ◆ Shadow * SHDW
- ◆ Titanium P8T

P2

- ◆ Champagne Metallic T4
- ◆ Platinum Metallic T1
- ◆ Silver PR6
- ◆ Solar Black P8X

P3

- ◆ Amethyst P091
- ◆ Atom P8S
- ◆ Blossom P8K
- ◆ Bullseye PJF
- ◆ Cabernet * P7T
- ◆ Cobalt Mica P090
- ◆ Conifer * P8H
- ◆ Ember P8P
- ◆ Ion P8N
- ◆ Iris P8J
- ◆ Krypton P8F
- ◆ Ochre P093
- ◆ Regatta P8M
- ◆ Sienna P092
- ◆ Succulent P8A

* Metal center drawer models HD2 and HD8 limited to P1 Paints, Champagne Metallic, and Platinum Metallic.

◆◆◆ For lead time information see page 17.

* De-emphasized

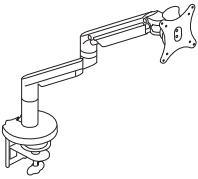
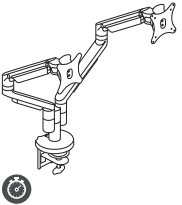
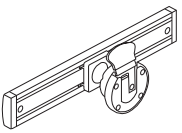
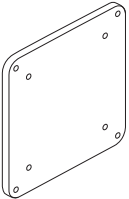

MONITOR ARMS

| | DESCRIPTION | MODEL | SHIP WEIGHT | CUBE | LIST PRICE |
|--|---|---------------|-------------|------|--------------|
|  | <p>Single Dynamic Monitor Arm</p> <ul style="list-style-type: none"> • 180° of rotation at base with optional 360° rotation. • Arms extend 22" and retract up to 3". • Monitor mount rotates 180° and tilts +/-30°. • Monitor can be rotated from landscape to portrait position. <p>! Arms hold monitors from 6.2-18 lbs. Optional counterweight HPACW available to support monitors as low as 5 lbs.</p> <p>! Back side of monitor arm base features opening for wire management through grommet when utilizing clamp mount.</p> | HMASTS | 11.5 | 0.8 | \$501 |
|  | <p>Dual Dynamic Monitor Arm</p> <ul style="list-style-type: none"> • Arms have 65° rotation at base with optional 130° and 360° rotations. • Arms extend 22" and retract up to 3". • Monitor mount rotates 180° and tilts +/-30°. • Monitor can be rotated from landscape to portrait position. <p>! Arms hold monitors from 6.2-18 lbs. Optional counterweight HPACW available to support monitors as low as 5 lbs.</p> <p>! Back side of monitor arm base features opening for wire management through grommet when utilizing clamp mount.</p> | HMASD | 17.0 | 1.1 | \$962 |
|  | <p>Sliding Mount for Monitor Arm</p> <ul style="list-style-type: none"> • Supports monitors up to 18 lbs. • Compatible with VESA 75mm and 100mm mounts. • Compatible with models HMASTS, HMASD, HPASD, HPADD, and HPATF. • Available in two paint finishes, Silver (SVR) and Black (BLK). Plastic components ship in like color with specified paint finish. | HPACSM | 3.0 | 0.3 | \$206 |
|  | <p>Monitor Arm Counterweight</p> <ul style="list-style-type: none"> • Optional counterweight for monitors as low as 5 lbs. • Minimum weight for monitors without counterweight is 6.2 lbs. <p>! Available in Black only, no specification needed.</p> <p>! Compatible with models HMASTS, HPASD, HMASD, HPADD, and HPATF.</p> | HPACW | 3.0 | 0.1 | \$30 |

SIN 33721

HOW TO SPECIFY

| | |
|--|--|
| <p>Select Model Number</p> <p>H M A S T S .</p> | <p>Select Finish</p> <p>SVR Silver BLK Black</p> <p>S V R</p> |
|--|--|



Icon Legend on page 17

MONITOR ARMS

WORKPLACE TOOLS

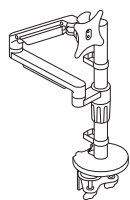

DESCRIPTION

Post Mount with Single Dynamic Arm

- Arm has 360° rotation at base.
- Monitor mount rotates 180° and tilts +/-30°.
- Monitor can be rotated from landscape to portrait position.
- Arm extends up to 20".
- Arm has 17¾" of vertical adjustment.

ⓘ Available in Silver (SVR) finish only.

ⓘ Arms hold monitors from 6.2-18 lbs. Optional counterweight HPACW available to support monitors as low as 5 lbs. (see page 183).

| MODEL | SHIP WEIGHT | CUBE | LIST PRICE |
|-------|-------------|------|------------|
| HPASD | 15.5 ☹ | 1.3 | \$732 |

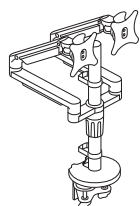

Post Mount with Dual Dynamic Arms

- Arms have 360° rotation at base.
- Monitor mount rotates 180° and tilts +/-30°.
- Monitor can be rotated from landscape to portrait position.
- Arms extend up to 20".
- Arms have 17¾" of vertical adjustment.

ⓘ Available in Silver (SVR) finish only.

ⓘ Arms hold monitors from 6.2-18 lbs. Optional counterweight HPACW available to support monitors as low as 5 lbs. (see page 183).

| | | | |
|-------|--------|-----|--------|
| HPADD | 19.5 ☹ | 1.3 | \$1064 |
|-------|--------|-----|--------|

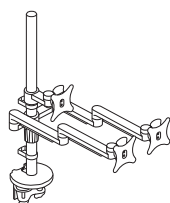

Post Mount with Triple Fixed Arms

- Features two fixed extended arms and one fixed center mount.
- Arms have 360° rotation at base.
- Monitor mount rotates 180° and tilts +/-30°.
- Monitor can be rotated from landscape to portrait position.
- Arms extend up to 20".
- Arms have 27½" of vertical adjustment.

ⓘ Available in Silver (SVR) finish only.

ⓘ Arms hold monitors from 6.2-18 lbs. Optional counterweight HPACW available to support monitors as low as 5 lbs. (see page 183).

| | | | |
|-------|--------|-----|--------|
| HPATF | 22.0 ☹ | 1.9 | \$1218 |
|-------|--------|-----|--------|

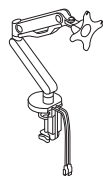

Single Monitor Arm with 2 USB Ports

NOTES: Easy adjustment. Height adjusts to 17" tall. Monitor tilt and swivel capability. Enclosed cable management. Grommet or desktop mounting. Clean appearance. **HON 5-Year Limited Warranty.**

ⓘ No specification needed.

ⓘ Cannot be used in Empower® height adjustable applications.

| | | | |
|----------|------|-----|-------|
| HBSMAUSB | 38.6 | 2.4 | \$274 |
|----------|------|-----|-------|

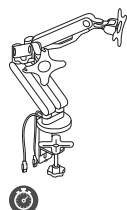

Dual Monitor Arm with 2 USB Ports

NOTES: Easy adjustment. Height adjusts to 17" tall. Monitor tilt and swivel capability. Enclosed cable management. Grommet or desktop mounting. Clean appearance. In some applications the Monitor Arms may extend 12 or more inches into the worksurface. **HON 5-Year Limited Warranty.**

ⓘ No specification needed.

ⓘ Cannot be used in Empower® height adjustable applications.

| | | | |
|----------|------|-----|-------|
| HBDMAUSB | 41.9 | 2.6 | \$410 |
|----------|------|-----|-------|

HOW TO SPECIFY

| | |
|--|---|
| <p>Select Model Number</p> <p>HPASD.</p> | <p>Select Finish</p> <p>SVR Silver</p> <p>SVR</p> |
|--|---|



CPU HOLDERS

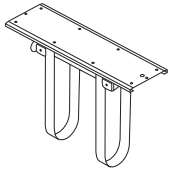

DESCRIPTION

360° Swivel CPU Holder with Adjustable Straps

- Supports CPUs 3¾" wide up to 64" perimeter and holds up to 75 lbs.
- 360° rotation.
- Ships complete and includes necessary mounting hardware and instruction sheet.

ⓘ Available in Black only, no specification needed.

| MODEL | SHIP WEIGHT | CUBE | LIST PRICE |
|-------|-------------|------|------------|
| HCPU1 | 7 | 0.2 | \$260 |



HOW TO SPECIFY

Select Model Number

H C P U 1

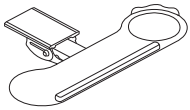

KEYBOARD TRAYS

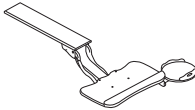
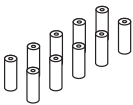
| | DESCRIPTION | MODEL | SHIP WEIGHT | CUBE | LIST PRICE |
|--|---|-----------------|--|------|--------------|
|  | Short Track and Keyboard Platform <ul style="list-style-type: none"> Height adjustable total of 5$\frac{3}{4}$" (1$\frac{3}{4}$" above and 4" below). +10°, -20° of tilt adjustment. 360° rotation. | HKTSHORT | 10  | 0.8 | \$602 |
|  | Mid Track with Keyboard and Mouse Platform <ul style="list-style-type: none"> Height adjustable total of 8" (3" above and 5" below). +10°, -20° of tilt adjustment. 360° rotation. | HKT MID | 17 | 1.2 | \$554 |
|  | Sit to Stand Long Track with Keyboard and Mouse <ul style="list-style-type: none"> Height adjustable total of 12$\frac{1}{2}$" (7$\frac{1}{2}$" above and 5" below). +10°, -20° of tilt adjustment. 360° rotation. | HKT LONG | 17 | 0.8 | \$647 |
|  | Keyboard Spacer <ul style="list-style-type: none"> Used when attaching HKT MID or HKT LONG to Coordinate™ and Voi® or Systems Worksurface with an external channel. The kit includes ten cylinder spacers and ten screws. Spacers are $\frac{3}{4}$"W x 2$\frac{1}{8}$"H. Specify one kit per keyboard tray. | HKBS | 1 | 0.8 | \$100 |

NOTES:

-  Black finish only, no specification needed.

HOW TO SPECIFY

Select
Model Number

H K T M I D

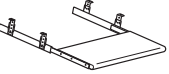
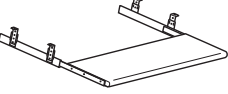

KEYBOARD TRAYS

| | DESCRIPTION | MODEL | SHIP WEIGHT | CUBE | LIST PRICE BY LAMINATE GRADE | |
|---|---|---------------|-------------|------|------------------------------|-------|
| | | | | | L1 | L2 |
|  | Laminate Keyboard Platform <ul style="list-style-type: none"> Laminate Tray dimensions: 21½"W x 10"D x 1⅛" Thick. Minimum clearance for mounting: 22⅞"W x 17"D. Surface can be positioned 2", 2½", 3" or 3½" below bottom of worksurface. Will not fit on a 37" x 24" Corner worksurface. Specify laminate. | H4022 | 10 | 0.6 | \$228 | \$243 |
|  | Laminate Keyboard Platform with Extended Tray <ul style="list-style-type: none"> Laminate Tray dimensions: 30"W x 10"D x 1⅛" Thick. Minimum clearance for mounting: 32½"W x 17"D. Surface can be positioned 2", 2½", 3" or 3½" below bottom of worksurface. Will not fit on a 37" x 24" Corner worksurface. Ball-bearing slide; slide and brackets are Black. | HE4022 | 12 | 0.7 | \$323 | \$338 |

HOW TO SPECIFY

| | |
|--|--|
| Select Model Number <input type="text" value="H4022"/> | Select Laminate See page 182 <input type="text" value="H"/> |
|--|--|

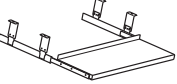
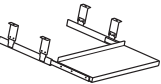
| | DESCRIPTION | MODEL | SHIP WEIGHT | CUBE | LIST PRICE BY PAINT GRADE | | |
|---|---|--------------|-------------|------|---------------------------|-------|-------|
| | | | | | P1 | P2 | P3 |
|  | Metal Keyboard Platforms 30"W Metal Keyboard and Mouse Tray <ul style="list-style-type: none"> Designed to hold keyboards and allow room for mouse pads. Tray dimensions: 30"W x 10"D. Minimum clearance for mounting: 32½"W x 15"D. Surface is positioned 3" below bottom of worksurface. Non-articulating, only movement is front-to-back. Does not tilt or swivel. Specify paint color. | H4028 | 11 | 1.5 | \$164 | \$174 | \$182 |
|  | 24"W Metal Keyboard Tray <ul style="list-style-type: none"> Designed to hold ONLY keyboards. Tray dimensions: 24"W x 10"D. Minimum clearance for mounting: 26½"W x 15"D. Surface is positioned 3" below bottom of worksurface. Non-articulating, only movement is front-to-back. Does not tilt or swivel. Specify paint color. | H4029 | 11 | 1.5 | \$148 | \$158 | \$166 |

HOW TO SPECIFY

| | |
|--|---|
| Select Model Number <input type="text" value="H4028"/> | Select Paint Color See page 182 <input type="text" value="P"/> |
|--|---|



Icon Legend on page 17

CORNER SLEEVES

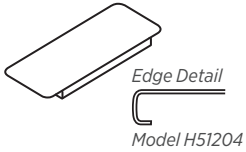
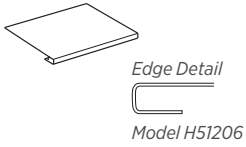
| | DESCRIPTION | MODEL | SHIP WEIGHT | CUBE | LIST PRICE BY PAINT GRADE | | |
|--|--|---------------|-------------|------|---------------------------|--------------|--------------|
| | | | | | P1 | P2 | P3 |
|  <p>Edge Detail Model H51204</p> | <p>Metal Corner Sleeves</p> <p>22½"W Leading Edge x 9"D</p> <ul style="list-style-type: none"> Fits 1⅝" thick square edge detail. Smaller design is more aesthetically pleasing. | H51204 | 10 | 1.5 | \$171 | \$178 | \$185 |
|  <p>Edge Detail Model H51206</p> | <p>22½"W Leading Edge x 18"D</p> <ul style="list-style-type: none"> Fits 1⅝" thick square edge detail. | H51206 | 10 | 1.5 | \$171 | \$181 | \$188 |

NOTES:

- Corner sleeve connects intersecting worksurfaces to create "corner desk" work areas.
- Specify paint color.

HOW TO SPECIFY

| | |
|---|---|
| <p>Select Model Number</p> <p>H 5 1 2 0 4 . P</p> | <p>Select Paint Color</p> <p>See page 182</p> |
|---|---|



CENTER DRAWERS

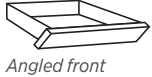

DESCRIPTION

Laminate Center Drawer

22"W x 15³/₈"D x 2¹/₂"H

Specify laminate.

26"W x 15³/₈"D x 2¹/₂"H

Specify laminate.

- Ball-bearing slide suspension.
- 12" drawer extension (3/4).
- Inside drawer dimension for H1522: 18⁷/₈"W x 15¹/₂"D x 1¹/₂"H.
- Inside drawer dimension for H1526: 22³/₄"W x 15¹/₂"D x 1¹/₂"H.
- Minimum clearance for mounting H1522: 22³/₄"W x 18¹/₂"D compatible with 72"W x 36"D, 66"W x 30"D, 60"W x 30"D Double Pedestal Desks, 72"W x 36"D, 66"W x 30"D Single Pedestal Desks, Bullet and P-Shaped Peninsulas, 72"W x 24"D, 66"W x 24"D, 60"W x 24"D Credenza w/Kneespace, 72"W x 24"D, 66"W x 24"D Single Pedestal Credenzas, 48"W x 24"D, 42"W x 24"D Returns
- Minimum clearance for mounting H1526: 27¹/₄"W x 18¹/₂"D compatible with 72"W x 36"D, 66"W x 30"D, 60"W x 30"D Double Pedestal Desks, 72"W x 24"D, 66"W x 24"D, 60"W x 24"D Credenza w/Kneespace, 48"W x 24"D Return
- Designed for use with Concinnity™, Voi®, Valido®/11500, 10700 and 10500 Series™.
- Includes pencil tray.

NOTES: For 60"W x 30"D Modular Desk Shells with two 15⁵/₈"W Storage Pedestals or 60"W x 24"D Modular Credenza Shells with two 15⁵/₈"W Storage Pedestals, use center drawer H1522.

| MODEL | SHIP WEIGHT | CUBE | L1 | L2 |
|-------|-------------|------|------------|------------|
| | | | LIST PRICE | LIST PRICE |
| H1522 | 11 | 1.1 | \$199 | \$214 |
| H1526 | 12 | 1.2 | \$214 | \$229 |

HOW TO SPECIFY

| | |
|----------------------------|------------------------|
| Select Model Number | Select Laminate |
| | See page 182 |
| H 1 5 2 2 . | H |



Icon Legend on page 17

CENTER DRAWERS

DESCRIPTION

| MODEL | SHIP WEIGHT | CUBE | LIST PRICE BY PAINT GRADE | |
|-------|-------------|------|---------------------------|----|
| | | | P1 | P2 |

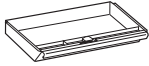

Angled front



Metal Center Drawer w/Lock
 19"W x 14³/₄"D x 3"H
 Specify paint color.

- Ball-bearing slide suspension.
- 12" drawer extension (3/4).
- Inside drawer dimension: 19"W x 13"D x 2³/₈"H.
- Minimum clearance for mounting: 21³/₄"W x 19¹/₄"D.
- Core removable lock.

| | | | | |
|------------|---|-----|--------------|--------------|
| HD2 | 9 | 1.0 | \$297 | \$307 |
|------------|---|-----|--------------|--------------|



Angled front



Metal Center Drawer w/Lock
 24³/₄"W x 14³/₄"D x 3"H
 Specify paint color.

- Ball-bearing slide suspension.
- 12" drawer extension (3/4).
- Inside drawer dimension: 24¹/₂"W x 13"D x 2³/₈"H.
- Minimum clearance for mounting: 27³/₈"W x 19¹/₄"D.
- Core removable lock.

| | | | | |
|------------|----|-----|--------------|--------------|
| HD8 | 12 | 1.2 | \$297 | \$307 |
|------------|----|-----|--------------|--------------|

DESCRIPTION

| MODEL | SHIP WEIGHT | CUBE | LIST PRICE |
|-------|-------------|------|------------|
|-------|-------------|------|------------|

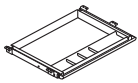

OPEN MARKET

Polymer Center Drawer

- Color: Black.
- Material: ABS.
- Minimum clearance for mounting: 23"W x 16¹/₄"D x 2"H.
- Retracts on 16" ball-bearing slides.
- Can be used on worksurfaces with Coordinate™ Height Adjustable Bases as long as it is attached with spacer model HKBS.
- Can store up to 25 lbs.

Black finish only, no specification needed.

| | | | |
|-------------|---|-----|--------------|
| HCD1 | 7 | 0.5 | \$126 |
|-------------|---|-----|--------------|

NOTES:

- All metal center drawers feature pencil trays with three compartments for storage.
- All metal center drawers feature core removable locks for greater personal and departmental security.

HOW TO SPECIFY

| | |
|--|---|
| <p>Select Model Number</p> <p>HD2 .</p> | <p>Select Paint Color</p> <p>See page 182</p> <p>P</p> |
|--|---|



Icon Legend on page 17

COORDINATE™ Desktop Riser

DESCRIPTION

Portable Desktop Riser
31"D x 5"-16½"H x 35"W

NOTES: Available in Black (BLK) or White (WHT) finish. Desktop riser dimensions (without keyboard tray): 22"D x 5"-16½"H x 35"W. Keyboard tray dimensions: 9"D x 30"W. Max loading capacity is 33 lbs for the desktop riser surface and 4 lbs for the keyboard tray. Easily transition from seated to standing positions throughout the workday. Sits atop an existing desk to create sit-to-stand functionality by raising the computer. Includes keyboard tray and surface for computer monitors. **HON 5-Year Limited Warranty.**

! Not intended for use on mobile workstations.

MODEL SHIP WEIGHT CUBE LIST PRICE

HBXRISER 54 4.1 \$657



HOW TO SPECIFY

| | |
|--|---|
| <p>Select Model Number</p> <p>HBXRISER.</p> | <p>Select Finish</p> <p>BLK Black WHT White</p> <p>BLK</p> |
|--|---|

ERGONOMIC SOLUTIONS



Icon Legend on page 17

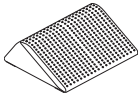

DESCRIPTION

Footrest — Anti-Slip Cover
13 3/4"D x 5 1/2"H x 16"W

ⓘ Available in Black (T) finish ONLY. Recommended weight capacity not to exceed 250 pounds. **HON 5-Year Limited Warranty.**
SPECIFYING EXAMPLE: HVL991.T

MODEL SHIP WEIGHT CUBE LIST PRICE

HVL991 7 ⓘ 0.9 \$89

WORKPLACE TOOLS

HOW TO SPECIFY

| | |
|---|--|
| <p>Select Model Number</p> <p>H V L 9 9 1 .</p> | <p>Select Finish</p> <p>T Black</p> <p>T</p> |
|---|--|

CHAIR MATS

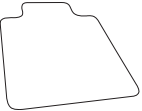
| | DESCRIPTION | MODEL | SHIP WEIGHT | CUBE | LIST PRICE |
|---|---|------------------|-------------|------|--------------|
|  | Lipped Chair Mat with Studs 60"W x 46"D 48"W x 36"D | HCM4660LS | 13.9 | 1.0 | \$158 |
| | | HCM3648LS | 8.8 | 0.6 | \$95 |
|  | Lipped Chair Mat without Studs 60"W x 46"D 48"W x 36"D | HCM4660LN | 13.2 | 0.5 | \$158 |
| | | HCM3648LN | 8.3 | 0.3 | \$95 |

NOTES:

- Available with studs for carpet and without studs for hard-surface floors.
 - Ships rolled.
 - **HON 5-Year Limited Warranty.**
- ⓘ Clear finish only. No specification needed.

HOW TO SPECIFY

Select Model Number

H C M 4 6 6 0 L S



TASK LIGHTS



DESCRIPTION

Articulating Desk Lamp

Articulating Desk Lamp w/ Occupancy Sensor

- Full-range dimming from 10% to 100%.
- Designed for 50,000 hours of life.
- Occupancy sensor is built into the head of the lamp and will automatically shut the lamp off after 6 minutes of undetected movement.
- Base swivel is 180 degrees.
- Uses only 5 watts of energy.
- Light comes with a silver 9' 4" power cord.
- Base diameter is 7.5".
- 3500K Color Temperature.
- 80 Color Rendering Index.
- TAA Compliant.

! Available in Matte Silver finish only, no specification needed.

MODEL

SHIP WEIGHT

CUBE

LIST PRICE

HLED1

1.2

6.5

\$430

HLED1OC

1.2

6.5

\$524



Task Desk Lamp

- Full-range dimming from 10% to 100%.
- Designed for 50,000 hours of life.
- Lamp is 15.83" tall.
- Desk lamp does not articulate at base. The pivoting head provides custom positioning, as it can be twisted 360 degrees.
- Uses only 5 watts of energy.
- Light comes with a silver 9' 4" power cord.
- Base diameter is 6.7".
- 3500K Color Temperature.
- 80 Color Rendering Index.
- TAA Compliant.

! Available in Brushed Nickel finish only, no specification needed.

HLED2

0.7

3.0

\$373

HOW TO SPECIFY

Select
Model Number

HLED1



TASK LIGHTS

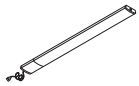

DESCRIPTION

LED Task Lights

17" LED Light with Power Supply (Single)
31" LED Light with Power Supply (Single)

17" LED Light with Power Supply for Daisy-chain (Starter)
31" LED Light with Power Supply for Daisy-chain (Starter)

17" LED Light with 8" Jumper Cord for Daisy-chain (Follower)
31" LED Light with 8" Jumper Cord for Daisy-chain (Follower)

Undercabinet Occupancy Sensor with 1" End to End Connector

NOTES: To use the daisy chain application, must start with model HLED17A or HLED31A. No finish specification required. Attaches magnetically to underside of overhead storage, or attaches with provided screws or double-sided tape. Occupancy sensor attaches to a single or starter LED light and will automatically turn the light off after no motion is detected for 30 minutes. Just like all the LED light models, the occupancy sensor features a soft-touch on/off switch. LED task lights have a lifetime of 50,000 hours and have a dimmer feature that allows the user to adjust the amount of light output.

MODEL

SHIP WEIGHT

CUBE

LIST PRICE

HLED17AS 1.2 0.05 **\$450**
HLED31AS 1.5 0.09 **\$603**

HLED17A 1.0 0.05 **\$493**
HLED31A 1.4 0.09 **\$662**

HLED17AUO 1.0 0.03 **\$404**
HLED31AUO 1.0 0.05 **\$539**

HLEDOSA 0.2 0.01 **\$97**

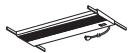

Recessed Task Lights

- Color: Black.
- Slim profile design.
- Mount to stack-on storage and wall mounted storage cabinets.
- Electronic ballast for increased energy efficiency.
- T5 fluorescent bulb included, which contains less mercury.
- 9-foot black cord and switch off right rear corner.

| | | | | |
|--|-------------------|------|------|--------------|
| 18 ³ / ₈ "W x 3 ¹ / ₁₆ "D x 1 ¹ / ₈ "H | HH870924 | 5.0 | 0.40 | \$243 |
| Chicago code version (with fused plug) | HH870924CH | 5.0 | 0.40 | \$308 |
| 22 ⁷ / ₈ "W x 3 ¹ / ₁₆ "D x 1 ¹ / ₈ "H | HH870930 | 7.0 | 0.60 | \$247 |
| Chicago code version (with fused plug) | HH870930CH | 7.0 | 0.60 | \$322 |
| 34 ⁵ / ₈ "W x 3 ¹ / ₁₆ "D x 1 ¹ / ₈ "H | HH870942 | 10.0 | 0.90 | \$267 |
| Chicago code version (with fused plug) | HH870942CH | 10.0 | 0.90 | \$339 |
| 46 ¹ / ₂ "W x 3 ¹ / ₁₆ "D x 1 ¹ / ₈ "H | HH870960 | 12.0 | 1.10 | \$290 |
| Chicago code version (with fused plug) | HH870960CH | 12.0 | 1.10 | \$361 |

HOW TO SPECIFY

Select
Model Number

HH870924

PAPER MANAGEMENT & ORGANIZATIONAL TOOLS

GSA SIN 33721



Icon Legend on page 17

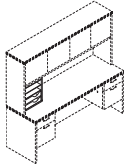

Not available in two-tone laminate

| DESCRIPTION | MODEL | SHIP WEIGHT | CUBE | LIST PRICE BY LAMINATE GRADE | |
|--|---------------|-------------|------|------------------------------|--------------|
| | | | | L1 | L2 |
| Vertical Paper Manager 14 ⁷ / ₈ "W x 10 ⁷ / ₈ "D x 19 ³ / ₈ "H NOTES: Keeps papers, files, and books neatly organized and within easy reach from a seated position. Designed for desk, credenza, and return tops. Fits under stack-on storage models. Two pullout drawers and three fixed shelves. Not available in pattern laminate colors. Ships fully assembled. ⓘ Requires 19 ³ / ₄ "H minimum of clear space between underside of overhead storage unit and worksurface. SPECIFYING EXAMPLE: HLVPM1.N | HLVPM1 | 27 | 2.8 | \$351 | \$361 |

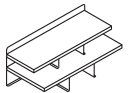

Not available in two-tone laminate



| | | | | | |
|--|---------------|----|-----|--------------|--------------|
| Desktop Storage Terrace 26 ¹ / ₂ "W x 12 ¹ / ₂ "D x 10 ¹ / ₂ "H NOTES: For use on the tops of 29 ¹ / ₂ "H desks, credenzas, and returns. Features six storage sections plus top display shelf. Keeps work-in-process, priority files, loose pages, and mail neatly organized and in view. Mixed material design comprised of sturdy laminate shelves with metal back and support panels. Not available in two-tone laminate combination or pattern laminate colors. Choose from Platinum Metallic (T1), Black (P), and Charcoal (S) for the metal components. Sized to fit in stack-on and wall mount storage cabinets in 10500, 10700, Valido, Concinnity, 94000, and 38000 Series. Fits in Concinnity and Voi sliding door models, except for 48"W or smaller models. Specify: Model.Laminate.Paint SPECIFYING EXAMPLE: HLDST1.N.T1 | HLDST1 | 24 | 1.1 | \$329 | \$339 |
|--|---------------|----|-----|--------------|--------------|

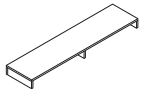

| | | | | | |
|---|--|----------|------------|------------------------------|------------------------------|
| Layering Shelf 72"W x 14 ¹ / ₂ "D x 5 ¹ / ₂ "H 60"W x 14 ¹ / ₂ "D x 5 ¹ / ₂ "H NOTES: Layering shelf works with lower credenzas to provide additional storage areas. ⓘ Layering Shelves cannot be stacked. ⓘ Cannot add a hutch on top of a layering shelf. | HLSL1472LS HLSL1460LS | 50 39 | 4.6 1.3 | \$488 \$410 | \$498 \$420 |
|---|--|----------|------------|------------------------------|------------------------------|

WORKPLACE TOOLS

HOW TO SPECIFY

| | |
|---|--|
| Select Model Number HLVPMT1.N | Select Laminate See page 182 |
|---|--|



PAPER MANAGEMENT & ORGANIZATIONAL TOOLS

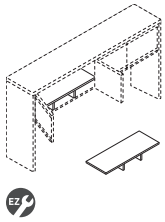

DESCRIPTION

Stacked Paper Management
32½"W x 12½"D x 4¼"H

MODEL SHIP WEIGHT CUBE LIST PRICE

HLVPM2 22 1.25 \$175

NOTES: Segments and organizes stack-on and wall mount storage compartments, as well as bookcase shelves. Unit can be used in Models H105327, H10534, H105322, H105321, H105382 and H105381.

- Available in Black finish only, no specification needed.
- In some cases, installation of Stacked Paper Management may require removing the stack-on or wall mount storage doors.

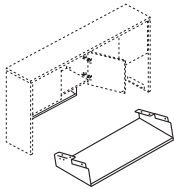

DESCRIPTION

Hanging Paper Shelf
28½"W x 11½"D x 4¾"H

MODEL SHIP WEIGHT CUBE LIST PRICE BY PAINT GRADE
P1 P2 P3

HHPS1 7 2.9 \$214 \$222 \$234

NOTES: Attaches quickly and easily (screws included). Maximizes worksurface space; de-clutters desktop while placing priority communications and active project folders within easy reach. Angled design allows contents to be distinguished at a glance. Mixed material styling features strong painted metal frame with a frosted shelf.

Attaches quickly and easily to laminate stack-on and wall mount storage models (except the 36"W Voi® overhead hutch with O-legs or panel mount brackets). Not for use with 38000 Series™ and Systems.

Specify: Model.Paint

SPECIFYING EXAMPLE: HHPS1.T1

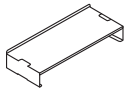

Desktop Paper Shelf
28½"W x 11½"D x 5"H

HDPS1 7 2.9 \$214 \$222 \$234

NOTES: Desktop Paper Shelf and Storage Terrace include protective, non-slip pads on the base. Paper Shelf can stack two-high. Organizer shelf provides a place and space for work-in-process and piling to keep worksurfaces neat and tidy. Convenient, scalable design with interlocking side supports allow two units to be stacked and integrated. Durable painted metal frame with a frosted shelf; mixed material styling matches hanging paper shelf.

Can also be used inside select overhead storage, including the following stack-on with clearance and hinged door models: 10500 and Valido 36", 42", 66", 72", 78"W and 10700 68½"W.

Specify: Model.Paint

SPECIFYING EXAMPLE: HDPS1.T1

WORKPLACE TOOLS

HOW TO SPECIFY

| | |
|----------------------------|---------------------------|
| Select Model Number | Select Paint Color |
| HHPS1 | See page 182 |
| P | |

PAPER MANAGEMENT & ORGANIZATIONAL TOOLS

GSA SIN 33721 EXCEPT AS NOTED



Icon Legend on page 17



DESCRIPTION

Storage Cube
12"W x 12"D
SPECIFYING EXAMPLE: HLSL1212.P8S

MODEL

HLSL1212

SHIP WEIGHT

1

CUBE

0.3

LIST PRICE BY PAINT GRADE

P1

\$316

P2

\$316

P3

\$316

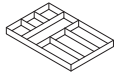

DESCRIPTION

Drawer Organizer
12"W x 14½"D x 1½"H
SPECIFYING EXAMPLE: HSLDRWORG.P8F

MODEL

HSLDRWORG

1

0.5

\$172

\$172

\$172

DESCRIPTION

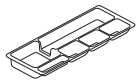
Optional Pencil Tray

 ⓘ For use with mobile and freestanding pedestal models.
 ⓘ No specification required.

MODEL

HV-UT1

SHIP WEIGHT

0.5

CUBE

0.1

LIST PRICE

\$77

DESCRIPTION

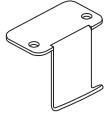
Back Pack Hook (10 per carton)
12"W x 14½"D x 1½"H
NOTES: Assembly: attaches to bottom of desk with (2) screws, included.

 ⓘ Available in Platinum Metallic finish only, no specification needed.

MODEL

HCLA65

10.0 ⓘ

0.1

\$101

OPEN MARKET



WORKPLACE TOOLS

HOW TO SPECIFY

Select Model Number

Select Paint Color

See page 182
Only specify for models HLSL1212 and HSLDRWORG



H L S L 1 2 1 2 .

P 8 S

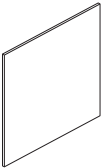
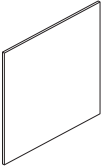
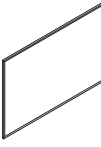

Icon Legend on page 17

PAPER MANAGEMENT & ORGANIZATIONAL TOOLS

| | DESCRIPTION | MODEL | SHIP WEIGHT | CUBE | LIST PRICE |
|---|---|------------------|-------------|--------------|--------------|
|  | Wall Mount Tackboard | | | | |
| | 36"W x 35¼"H | HNL3636TB | 20 | 2.9 | \$323 |
| | 30"W x 35¼"H | HNL3630TB | 16 | 2.9 | \$275 |
| | 36"W x 48⅝"H | HNL4936TB | 27 | 5.5 | \$359 |
| | 30"W x 48⅝"H | HNL4930TB | 22 | 3.7 | \$312 |
| | NOTES: When positioned above 29½"H floor-standing storage, the sizes align with overhead storage height options. Can be positioned side-by-side with corresponding wall mount markerboard sizes. Easy to install; includes mounting hardware. Attaches to wall with horizontally mounted, interlocking Z-clip brackets. For the space directly below stack-on and wall mount storage cabinets, use the 18"H tackboard models listed in the Desks section in the 2021 Workspaces Pricer. SPECIFYING EXAMPLE: HNL3636TB.APN15 | | | | |
|  | Wall Mount Markerboard | | | | |
| | 36"W x 35¼"H | HNL3636WB | 16 | 2.9 | \$221 |
| | 30"W x 35¼"H | HNL3630WB | 14 | 2.9 | \$206 |
| | 36"W x 48⅝"H | HNL4936WB | 22 | 5.5 | \$270 |
| | 30"W x 48⅝"H | HNL4930WB | 20 | 3.7 | \$249 |
| | NOTES: Smooth, white, magnetic surface. Metal material produces clear graphics and cleans easily. Compatible for use with dry- or wet-erase markers. When positioned above 29½"H floor-standing storage, the sizes align with overhead storage height options. Can be positioned side-by-side with corresponding wall mount tackboard sizes. Easy to install; includes mounting hardware. Attaches to wall with horizontally mounted, interlocking Z-clip brackets. SPECIFYING EXAMPLE: HNL3636WB | | | | |
|  | Markerboard | | | | |
| 48"W x 31"H | HLSL4831MB | 44 | 3.4 | \$713 | |
| | NOTES: Wall mounted. ! No specification required. | | | | |
| OPEN MARKET   | | | | | |

WORKPLACE TOOLS

HOW TO SPECIFY

| | |
|---|--|
| <p>Select Model Number</p> <p>H N L 3 6 3 6 T B</p> | <p>Select Fabric Color</p> <p>See pages 23-24</p> <p>A P N 1 1</p> |
|---|--|

INTERLINK IQ ELECTRICAL

Specification guide for IQ Electrical on Training tables

Determine table width, the type of power access being used (3" grommet or 4x8 pop-up) and the desired number per table (Columns 1, 2 or 3). The table will then identify the type and quantity of components needed per table along with the maximum table run. Note that this is in addition to the Power base in-feed which is needed for each run. For example, a 48"W table with two 3" power grommets per table will require (1) HQH5-3 harness and (1) HQH1-3 harness per table with a maximum run of four tables.



| Top Width | POWER ONE (1) PER TABLE 3" ROUND POWER GROMMET | | POWER TWO (2) PER TABLE 3" ROUND POWER GROMMETS | | POWER ONE (1) PER TABLE 4x8 POP-UP PORT | |
|------------------------|---|------------------------|--|--------------------|--|--------------------|
| | | | | | | |
| 36" | (1) HQH5-3 | 8 Table Run Maximum | N/A | N/A | (1) HQH5-P | 8 Max Table Run |
| 42" | (1) HQH5-3 | 8 Table Run Maximum | N/A | N/A | (1) HQH5-P | 8 Max Table Run |
| 48" | (1) HQH5-3 | 8 Table Run Maximum | (1) HQH5-3 (1) HQH1-3 | 4 Max Table Run | (1) HQH5-P | 8 Max Table Run |
| 54" | (1) HQH5-3 | 8 Table Run Maximum | (1) HQH5-3 (1) HQH1-3 | 4 Max Table Run | (1) HQH5-P | 8 Max Table Run |
| 60" | (1) HQH5-3 | 8 Table Run Maximum | (1) HQH5-3 (1) HQH1-3 | 4 Max Table Run | (1) HQH5-P | 8 Max Table Run |
| 66" | (1) HQH5-3 (1) HJQ3 | 4 Table Run Maximum | (1) HQH5-3 (1) HQH1-3 | 4 Max Table Run | (1) HQH5-P (1) HJQ3 | 4 Max Table Run |
| 72" | (1) HQH5-3 (1) HJQ3 | 4 Table Run Maximum | (1) HQH5-3 (1) HQH1-3 | 4 Max Table Run | (1) HQH5-P (1) HJQ3 | 4 Max Table Run |
| 84" | (1) HQH5-3 (1) HJQ3 | 4 Table Run Maximum | (2) HQH5-3 | 4 Max Table Run | (1) HQH5-P (1) HJQ3 | 4 Max Table Run |
| 96" | (1) HQH5-3 (1) HJQ3 | 4 Table Run Maximum | (2) HQH5-3 | 4 Max Table Run | (1) HQH5-P (1) HJQ3 | 4 Max Table Run |
| Half-Round (all sizes) | (1) HQH1-3 | 2 Tables Maximum | N/A | N/A | (1) HQH5-P | 2 Max Table Run |
| Trapezoid (all sizes) | (1) HQH5-3 | 8 Table Run Maximum | N/A | N/A | (1) HQH5-P | 8 Max Table Run |

NOTES:

- Interlink IQ Electrical is a pluggable, single circuit electrical system.
 - All electrical models include wire management clips and hardware.
 - Interlink IQ Electrical is non-sequential/non-directional.
 - Interlink IQ Electrical is UL Recognized as a Powered Table System and meets the requirements of UL 962 when paired with Motivate® or Huddle tables.
- ⓘ 40' maximum run, or no more than 8 units, whichever comes first. Interlink IQ system will automatically shut off if maximum requirements are exceeded. Maximum run is based upon electrical harness width, not table width.

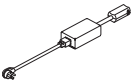
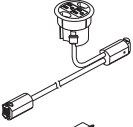
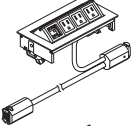
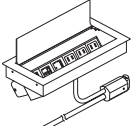
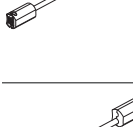
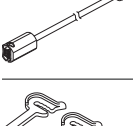
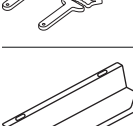
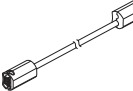

INTERLINK IQ ELECTRICAL

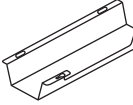
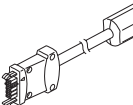
| | DESCRIPTION | MODEL | SHIP WEIGHT | CUBE | LIST PRICE |
|---|---|--|-------------|------------|-----------------------------|
|  | Power Base In-Feed <ul style="list-style-type: none"> 12 amp circuit breaker is built in to the Power Base In-Feed. Available in Black finish, no specification needed. | HQB | 2.0 | 0.2 | \$566 |
|  | Power Harness – 1' Power Hub, 3" Round Grommet Mount <ul style="list-style-type: none"> Available in Black finish, no specification needed. | HQH1-3 | 2.0 | 0.2 | \$186 |
|  | Power Harness – 5' Power Hub, 3" Round Grommet Mount <ul style="list-style-type: none"> Available in Black finish, no specification needed. | HQH5-3 | 2.0 | 0.2 | \$208 |
|  | Power Harness – 5' with 4" x 8" Pop-Up Port (3 Power, 1 Blank) <ul style="list-style-type: none"> For use with tables G1 grommet. Specify paint. | HQH5-P-3P1B | 3.0 | 0.3 | \$408 |
|  | Power Harness – 5' with 5" x 11" Flip-Top Port (3 Power, 3 Blank) <ul style="list-style-type: none"> For use with Preside® G2 grommet. Specify paint. | HQH5-E-3P3B | 5.0 | 0.2 | \$429 |
|  | Power Harness – 5' with 5" x 11" Flip-Top Port (3 Power, 1 Extron Double Space) <ul style="list-style-type: none"> For use with Preside® G2 grommet. Specify paint. | HQH5-E-3P1E | 5.0 | 0.2 | \$452 |
|  | Power Harness – 5' with 5" x 11" Flip-Top Port (3 Power, 2 USB, 2 Blank) <ul style="list-style-type: none"> For use with Preside® G2 grommet. Specify paint. | HQH5-E-3P1U2B | 5.0 | 0.2 | \$473 |
|  | Power Jumper – 3' <ul style="list-style-type: none"> Available in Black finish, no specification needed. | HQJ3 | 2.0 | 0.2 | \$117 |
|  | Ganging Hardware <ul style="list-style-type: none"> Includes two ganging links and two screws. No color designator when specifying. <i>Example: HMAGANG.</i> | HMAGANG | 1.0 | 0.1 | \$102 |
|  | Cable Management Troughs 17"W – Single 17"W – 10-Pack <ul style="list-style-type: none"> Available in Graphite finish, no specification needed. NOTES: For additional information see page 208. | HCTROUGH17 HCTROUGH1710 | 2.7 14.0 | 0.5 0.5 | \$73 \$665 |
|  | IQ 1.0 Backward Compatible Jumper 36" <ul style="list-style-type: none"> Available in Black finish, no specification needed. Use when connecting Interlink IQ 1.0 power harness (rectangle end) to Interlink IQ 2.0 (oval end) power harness. ! If using Interlink IQ 2.0 in-feed with Interlink IQ 1.0 power harness please contact Customer Support. | HQBCJ36 | 2.0 | 0.2 | \$89 |

NOTES:

- Use HQH5-P models with G1 table top cutouts and HQH5-E models with G2 table top cutouts.
- Interlink IQ Electrical is a pluggable, single circuit electrical system.
- All electrical models include wire management clips and hardware.
- Interlink IQ Electrical is non-sequential/non-directional.
- Interlink IQ Electrical is UL Recognized as a Powered Table System and meets the requirements of UL 962 when paired with Motivate® or Huddle tables.
- !** 40' maximum run, or no more than 8 units, whichever comes first. Interlink IQ system will automatically shut off if maximum requirements are exceeded. Maximum run is based upon electrical harness width, not table width.

HOW TO SPECIFY

| | |
|---|--|
| Select Model Number H Q H 5 - E - 3 P 3 B . | Select Paint Color FOG Fog SVR Silver BLK Black S V R |
|---|--|

4-TRAC HARDWIRE ELECTRICAL SYSTEM

4-Trac Electrical System

The 4-Trac Electrical System is a UL-recognized Manufactured Wiring System that seamlessly passes power from one worksurface to another. This low-profile non-sequential electrical system allows tables to be “daisy-chained” together in any desired order and allows users to reconfigure quickly due to simple connectable/disconnectable links.

- Meets requirements of UL 183 and National Electric Code Article 604
- 4-Wires, 2-circuits, 20 Amps each (Circuit 1 and Circuit 2 only)
- 13 Duplex Receptacles per circuit, 26, 15 Amp Duplex receptacle per power in-feed
- Electrical system attaches directly to underside of worksurface with included brackets
- Up to twelve tables can be linked together

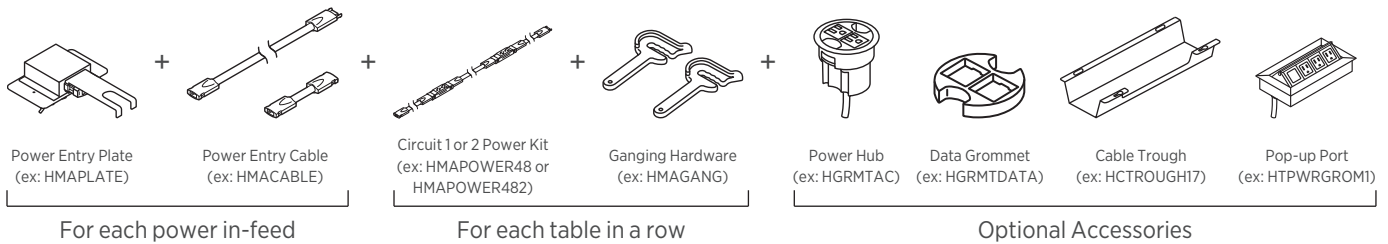



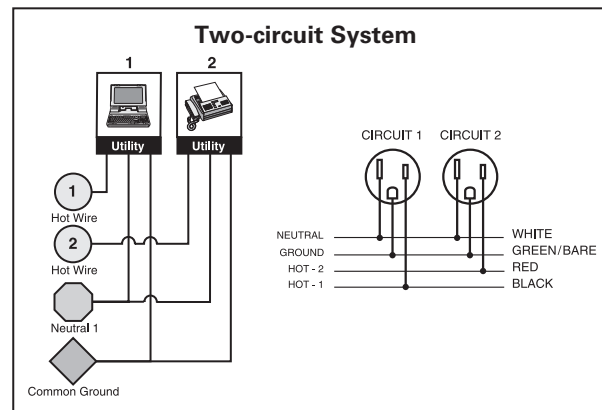
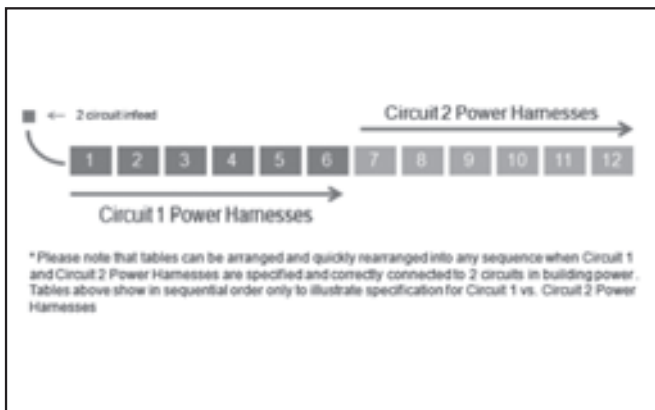

Steps for Electrical Specifications:

- Determine how many rows of tables are needed and order the following:
 - One HMAPLATE per row (or power in-feed)
 - One HMACABLE per row (or power in-feed)
- Order one power harness per table in each row
 - For 1-6 tables in a row (see illustration 1)
 - Order Circuit 1 Power Harnesses (ex. If powering six 24x60 tables order six sets of HMAPOWER60)
 - For 7-12 tables in a row (see illustration 1)
 - Order Circuit 1 Power Harness for first six tables and Circuit 2 Power Harness for remaining tables (ex. If powering eight 24x60 tables, order six sets of HMAPOWER60 and two sets of HMAPOWER602)
- Order one set of ganging hardware per table (ex. HMAGANG)
- Determine which accessories are needed:
 - Power Hub model HGRMTAC — to access power at worksurface.
 - Data Grommet model HGRMTDATA — to access data at worksurface.
 - Wire Management strips model HBTMS — for vertical and horizontal wire management.

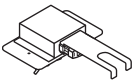
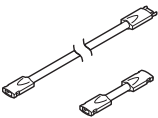

4-TRAC HARDWIRE ELECTRICAL SYSTEM

| | DESCRIPTION | MODEL | SHIP WEIGHT | CUBE | LIST PRICE |
|---|---|--------------------|-------------|--------------|--------------|
|  | Power Entry Plate | HMAPLATE | 1.0 | 0.2 | \$102 |
|  | Power Entry Cable • 6' power entry cable with male/female adapter. • Connects table to power entry plate. | HMACABLE | 1.8 | 0.2 | \$159 |
|  | Power Jumper Cable To connect tables front to front | HMAJUMP | 0.5 | 0.3 | \$54 |
|  | Circuit 1 Power Kit for 36" W Table | HMAPOWER36 | 1.5 | 0.3 | \$289 |
| | Circuit 1 Power Kit for 42" W Table | HMAPOWER42 | 1.8 | 0.3 | \$292 |
| | Circuit 1 Power Kit for 48" W Table | HMAPOWER48 | 1.8 | 0.3 | \$294 |
| | Circuit 1 Power Kit for 54" W Table | HMAPOWER54 | 2.0 | 0.3 | \$299 |
| | Circuit 1 Power Kit for 60" W Table | HMAPOWER60 | 2.0 | 0.3 | \$302 |
| | Circuit 1 Power Kit for 66" W Table | HMAPOWER66 | 2.2 | 0.3 | \$306 |
| | Circuit 1 Power Kit for 72" W Table | HMAPOWER72 | 2.2 | 0.3 | \$309 |
| | Circuit 1 Power Kit for 84" W Table | HMAPOWER84 | 2.4 | 0.3 | \$320 |
| | Circuit 1 Power Kit for 96" W Table | HMAPOWER96 | 2.6 | 0.3 | \$331 |
| | Circuit 2 Power Kit for 36" W Table | HMAPOWER362 | 1.5 | 0.3 | \$289 |
| | Circuit 2 Power Kit for 42" W Table | HMAPOWER422 | 1.8 | 0.3 | \$292 |
| | Circuit 2 Power Kit for 48" W Table | HMAPOWER482 | 1.8 | 0.3 | \$294 |
| | Circuit 2 Power Kit for 54" W Table | HMAPOWER542 | 2.0 | 0.3 | \$299 |
| | Circuit 2 Power Kit for 60" W Table | HMAPOWER602 | 2.0 | 0.3 | \$302 |
| Circuit 2 Power Kit for 66" W Table | HMAPOWER662 | 2.2 | 0.3 | \$306 | |
| Circuit 2 Power Kit for 72" W Table | HMAPOWER722 | 2.2 | 0.3 | \$309 | |
| Circuit 2 Power Kit for 84" W Table | HMAPOWER842 | 2.4 | 0.3 | \$320 | |
| Circuit 2 Power Kit for 96" W Table | HMAPOWER962 | 2.6 | 0.3 | \$331 | |
|  | Electrical Connectors 4-Way Splitter  Available in Black (P) only. SPECIFYING EXAMPLE: HMASPLIT.P | HMASPLIT | 0.9 | 0.1 | \$55 |

NOTES:

- Each power kit includes two duplex receptacles and attaches to the underside of the worksurface with included brackets.
- Power Kits are compatible with various base types including nesting bases.
- Available in Black finish, no specification needed.

HOW TO SPECIFY

Select
Model Number

H M A P L A T E

POWER & CABLE MANAGEMENT



Black only

SIN 33721

DESCRIPTION**Black Field Installable Grommet with One Access Hole**

- Intended for use in tops and end panels to route/hide cords and facilitate reaching wall electrical outlets.
- Requires a 2½" diameter hole saw and drill for installation (not included).
- Grommet cap measures 3" diameter and includes a ¾" diameter cord access hole.
- Grommet sleeve measures 2½" O.D. x ¾" thick.
- Includes instructions to locate grommet position for desks, credenzas, returns and bridges.

⚠ The grommet is not designed to be used with the following HON Series: 94000, 38000, Mentor®, Metro Classic or 34000.

MODEL

HFLDGRMT

SHIP WEIGHT

0.1 Ⓢ

CUBE

0.01

LIST PRICE

\$35



SIN 33721

Black Field Installable Grommet with Two Access Holes

- Requires a 3" diameter hole saw and drill for installation (not included).
- Grommet outside dimensions measures 3½" diameter.
- Grommet sleeve measures 3" O.D. x 1" thick.
- Includes instructions to locate grommet position for desks, credenzas, returns and bridges.

HFLDGRMT3

0.1 Ⓢ

0.3

\$35



OPEN MARKET

Platinum Field Installable Grommet with Two Access Holes

- Requires a 3" diameter hole saw and drill for installation (not included).
- Outside dimension measures 3½" diameter.
- Sleeve hole in worksurface measures 3" O.D. x 1" thick.
- Includes instructions to locate grommet position for desks, credenzas, returns, and bridges.

HFLDGRMT4

0.1

0.01

\$35

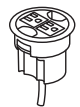

SIN 33721T

Power Hub, 3" Grommet Mount, 6' Cord

- Fits in 3" round grommet holes.
- Two grounded AC power outlets.
- Includes 6' cord with three-prong plug.
- Field installed with Plug-and-play ease.

⚠ Available in black only (no color designation so use .X - Specify: HGRMTAC.X).

HGRMTAC

1.3

0.2

\$126

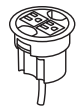

SIN 33721T

3" Round Power Grommet - 2 Outlets, 10' Cord

- Includes 10' cord with three-prong plug.
- Fits in 3" round grommet holes.
- Two grounded AC power outlets.
- Field installed with Plug-and-play ease.

NOTES: Power Modules will also work with standing-height applications for 10500 Series™ and Voi® desks. Optional Memory Control allows preset worksurface heights for consistency. Ships separately. Dynamic load capacity when worksurface is moving is 300 lbs.

⚠ Available in black finish only, no specification needed.

HGRMTAC2

1.5

0.2

\$159



SIN 33721T

Power/USB Hub, 3" Grommet Mount

- One grounded AC power outlet with 2 USB ports.
- UL Listed.

⚠ Available in black only (no color designation so use .X - Specify: HGRMTUSB2.X).

⚠ Not compatible with Arrange® tables.

HGRMTUSB2

1.3 Ⓢ

0.2

\$250



SIN 33721

Data Grommet

- Blank grommet kit that includes adapters for a variety of manufacturers jacks and couplers.
- Fits in existing 3" round grommet housing.

⚠ Available in black only. Specify P when ordering. Example: HGRMTDATA.P.

HGRMTDATA

0.2

0.2

\$23

HOW TO SPECIFYSelect
Model Number

H F L D G R M T



Icon Legend on page 17

POWER



Model HPWRMOD3WC shown

DESCRIPTION

Dean Power Modules with Worksurface Clamp

- 3 Receptacles
- 2 Receptacles, 2 USB
- 2 Receptacles, 2 USB with Qi Wireless Charging Top
- 6' power cord with standard three-prong plug.
- Worksurface clamp models work on any top with a 4" overhang.
- UL Listed.

MODEL

- HPWRMOD3WC
- HPWRMOD2WC
- HPWRMOD4WC

SHIP WEIGHT

- 2.3
- 2.3
- 2.3

CUBE

- 0.2
- 0.2
- 0.2

LIST PRICE

- \$342
- \$546
- \$738

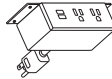

Model HPWRMOD2UWM shown

Dean Power Modules with Under-Worksurface Mounting Bracket

- 3 Receptacles
- 2 Receptacles, 2 USB
- 6' power cord with standard three-prong plug.
- Under-worksurface mounting bracket models work with any top that has a 5" x 5" square clearance.
- UL Listed.

- HPWRMOD3UWM
- HPWRMOD2UWM

- 2.3
- 2.3

- 0.2
- 0.2

- \$342
- \$546

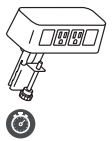

Power & Data Center

- 2 Receptacles 2 Data Accessory
- Standard with two receptacles and openings for two data ports.
- 6' power cord with standard three-prong plug.
- Fits on any worksurface with a 4" overhang.
- UL Listed.

HCOMDOME2

2.5

0.2

\$327

Color finish coordinates with HON's Loft. Specify LOFT when ordering. Example: HCOMDOME2.LOFT.

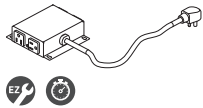

Under Worksurface Power Module — 4 Outlets, 10' Cord

- Includes 10' cord with three-prong plug.
- Fits in cable management troughs. See page 208.
- 4 outlets on side create easy access.

HPWRMOD2

1.5

0.2

\$441

NOTES: Power Modules will also work with standing-height applications for 10500 Series™ and Voi® desks.

Available in black finish only, no specification needed.

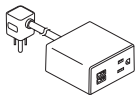

OPEN MARKET

Miki Surface Sit Power Module

- Includes 6' cord with three-prong plug.
- 1 Receptacle, 2 USB
- Unit features non-slip grip on underside.

HSMPOWER-1P-2U

2.0

0.6

\$166

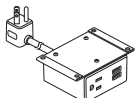

OPEN MARKET

Miki Under-Worksurface Power Module

- Includes 6' cord with three-prong plug.
- 1 Receptacle, 2 USB

HUMPWR-1P-2U

2.0

0.6

\$191



OPEN MARKET

Vesta Mobile Power Station

- Includes 10' retractable cord with three-prong plug.
- 3 AC, 1 Dual USB-A, 1 USB-C at top
- 2 AC at base
- Specify Paint and Plastic.

HPWRMOB1

14.0

3.3

\$1100

SPECIFYING EXAMPLE: HPWRMOB1.BLK.STRM

HOW TO SPECIFY

| | |
|--|--|
| <p>Select Model Number</p> <p>H S M P W R - 1 P - 2 U .</p> | <p>Select Plastic</p> <p>Specify for Dean and Miki models</p> <p>STRM Storm SNW Snow</p> <p>S N W</p> |
| <p>Select Model Number</p> <p>H P W R M O B 1 .</p> | <p>Select Exterior Paint Color</p> <p>Specify for model HPWRMOB1 only</p> <p>FOG Fog STRM Storm BLK Black SNW Snow</p> <p>B L K .</p> <p>Select Paint Color</p> <p>Specify for model HPWRMOB1 only</p> <p>FOG Fog STRM Storm BLK Black SNW Snow</p> <p>S T R M</p> |

WORKPLACE TOOLS



Icon Legend on page 17

POWER



| DESCRIPTION | MODEL | SHIP WEIGHT | CUBE | LIST PRICE |
|---|----------------------|-------------|------|--------------|
| MhoB 4" x 8" Pop-up Port <ul style="list-style-type: none"> Specify G1 cutout in table top. Pop-up Port provides three power ports and one blank data receptacle. Sits flush with worksurface when closed. Includes 6' cord with three-prong plug. | HTG1PWR-3P-1B | 5 | 0.3 | \$424 |

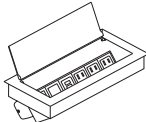

| | | | | |
|--|----------------------|---|-----|--------------|
| ElloraB 5" x 11" Flip-top Port <ul style="list-style-type: none"> Specify G2 cutout in table top. Flip-top Port provides four power ports and two blank data receptacles. Conceals wires and allows power cords to be plugged in while in use. Includes 10' cord with three-prong circuit breaker plug. <p>NOTES: Two circuit breaker plugs do not fit into one duplex.</p> | HTG2PWR-4P-2B | 5 | 0.3 | \$626 |
|--|----------------------|---|-----|--------------|

| | | | | |
|---|----------------------|---|-----|--------------|
| ElloraB 5" x 11" Flip-top Port <ul style="list-style-type: none"> Specify G2 cutout in table top. Flip-top Port provides one blank for Extron plate and three power ports. Extron AAP plates can be integrated into grommet to support changing technology. Conceals wires and allows power cords to be plugged in while in use. Includes 10' cord with three-prong plug. | HTG2PWR-3P-1E | 5 | 0.3 | \$767 |
|---|----------------------|---|-----|--------------|

| | | | | |
|---|-------------------------|---|-----|--------------|
| ElloraB 5" x 11" Flip-top Port <ul style="list-style-type: none"> Specify G2 cutout in table top. Flip-top Port provides 3 Power, 1 USB, and 2 Blank Data Ports. Conceals wires and allows power cords to be plugged in while in use. Includes 10' cord with three-prong plug. | HTG2PWR-3P-2B-2U | 5 | 0.3 | \$909 |
|---|-------------------------|---|-----|--------------|

| | | | | |
|---|------------------------|---|-----|--------------|
| ElloraB 5" x 11" Flip-top Port <ul style="list-style-type: none"> Specify G2 cutout in table top. Flip-top Port provides 3 Power, 1 USB, and Qi wireless charging lid. Conceals wires and allows power cords to be plugged in while in use. Includes 10' cord with three-prong plug. | HTG2PWR-3P-1U-W | 5 | 0.3 | \$930 |
|---|------------------------|---|-----|--------------|

WORKPLACE TOOLS

HOW TO SPECIFY

| | |
|---|--|
| Select Model Number HTG2PWR-4P-2B | Select Paint Color SVR Silver BLK Black FOG Fog BLK |
|---|--|

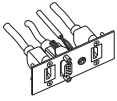

DESCRIPTION

Extron Plate (Double Space) — VGA, HDMI, HDMI, Audio

MODEL

HTPLATEVHAU

SHIP WEIGHT

1

CUBE

0.1

LIST PRICE

\$428

NOTES:

- 1 Double Space Plate can be used with HTG2PWR-3P-1E or HTPWRGROM4 Flip-top Port.
- ! Available in Black finish only, no specification needed.

HOW TO SPECIFY

Select Model Number

H T P L A T E V H A U

POWER & CABLE MANAGEMENT

Icon Legend on page 17

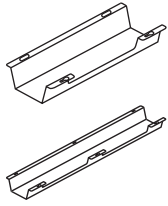

DESCRIPTION

Cable Management Troughs

17"W — Single
17"W — 10-Pack
36"W — Single
36"W — 10-Pack

- Cable management troughs ship flat packed.
- The troughs attach to underneath the worksurface with screws.
- Cutouts in trough allow access to power without the need to detach from surface. 17"W = 1 cutout; 36"W = 2 cutouts.
- Color: Graphite.
- Material: Metal.
- TAA Compliant.

MODEL

HCTROUGH17
HCTROUGH1710
HCTROUGH36
HCTROUGH3610

SHIP WEIGHT

2.7 **Ⓢ**
14.0 **Ⓢ**
4.9 **Ⓢ**
30.0 **Ⓢ**

CUBE

0.5
0.5
0.9
0.9

LIST PRICE

\$73
\$665
\$122
\$1121



OPEN MARKET

O-Leg Cord Clips

Clips for 28½" Worksurface O-Legs — 8-Pack
Clips for Stack-on Storage, Hutch and Layering O-Legs — 4-Pack

HWMCLIPLG
HWMCLIPSM

0.8 **Ⓢ**
0.5 **Ⓢ**

0.1
0.1

\$110
\$73

NOTES: Wire clips work with 7" Low Credenza O-leg and 29"H Support O-leg. Wire clips also work with the 50" and 65" Overhead O-leg supports.

- ! Available in frosted plastic material only.

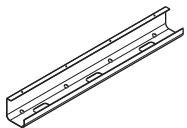

Black only

Cable Management Tray

24"
36"

- ! Available in Black only.

HHCMT24
HHCMT36

2.0 **Ⓢ**
3.0 **Ⓢ**

0.3
0.4

\$82
\$101



Vertical Wire Management Vertebrae

NOTES: 30"H x 3⅞"W x 1½"D. Ships unassembled.

- ! Clear finish. Specify "X" for finish option.

SPECIFYING EXAMPLE: HMPVWM28.X

HMPVWM28

3.0

0.3

\$246

HOW TO SPECIFY

Select
Model Number

Select
Paint Color

P Black

H H C M T 2 4 .

P

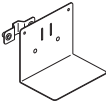
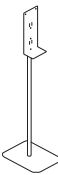
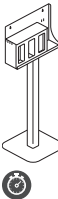
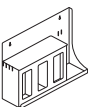

HEALTHY WORKPLACE TOOLS

| | DESCRIPTION | MODEL | SHIP WEIGHT | CUBE | LIST PRICE BY PAINT GRADE | | |
|---|--|-------------------------|-------------|------|---------------------------|-------|-------|
| | | | | | P1 | P2 | P3 |
|  | Hand Sanitizer Station Mounting Area: 6"W x 12"H Base: 12"W x 16"H NOTES: Freestanding. Stand is compatible with most manufacturers' automatic hand sanitizer dispensers, sold separately. No assembly required. Metal base for added stability. | HHC-SANSTND | 15 | 6.1 | \$278 | \$304 | \$316 |
|  | Retrofit Tray Kit for Sanitizer Station NOTES: Allows for easy conversion of HHC-SANSTND to HHC-SANSTND2. Adjustable strap allows for usage with most hand sanitizer bottles with pump or wipe containers. | HHC-SANSTND-TRAY | 8 | 0.2 | \$82 | \$95 | \$101 |
|  | Hand Sanitizer Station with Tray NOTES: Freestanding. Stand is compatible with most manufacturers' automatic hand sanitizer dispensers, sold separately. Adjustable strap allows for usage with most hand sanitizer bottles with pump or wipe containers. No assembly required. Metal base for added stability. | HHC-SANSTND2 | 15 | 6.1 | \$319 | \$345 | \$357 |
|  | Freestanding PPE Stand NOTES: Freestanding. 3 closed compartments fit most manufacturers' boxed PPE, including gloves, masks, wipes, and tissues. Closed compartments have adjustable back to best fit. Each closed compartment measures 5"W x 5¼"D x 10"H. Open space can accommodate most manufacturers' automatic hand sanitizer dispensers, hand sanitizer bottles, or wipe containers, sold separately. | HHC-PPESTND | 39 | 7.7 | \$600 | \$652 | \$676 |
|  | Wall Mounted PPE Stand NOTES: Wall mounted. 3 closed compartments fit most manufacturers' boxed PPE, including gloves, masks, wipes, and tissues. Closed compartments have adjustable back to best fit. Each closed compartment measures 5"W x 5¼"D x 10"H. Open space can accommodate most manufacturers' automatic hand sanitizer dispensers, hand sanitizer bottles, or wipe containers, sold separately. ⓘ Model does not come equipped with wall mounted hardware. | HHC-PPEWALL | 14 | 2.2 | \$336 | \$375 | \$393 |

WORKPLACE TOOLS

HOW TO SPECIFY

| | |
|---|-----------------------------|
| Select Model Number HHC-SANSTND | Select Finish P8T |
|---|-----------------------------|

HEALTHY WORKPLACE TOOLS

OPEN MARKET

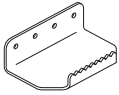
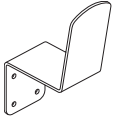

Icon Legend on page 17

| | DESCRIPTION | MODEL | SHIP WEIGHT | CUBE | LIST PRICE |
|--|--|-----------------------|-------------|------|---------------|
|  | Metal Foot Pull 5"W x 3¾"D x 1½"HK | | | | |
| | Pack of 5 | HHC-FOOTPULL5 | 8 | 0.7 | \$358 |
| | Pack of 15 | HHC-FOOTPULL15 | 23 | 0.7 | \$1001 |
|  | Metal Arm Pull 2½"W x 4½"D x 7½"H | | | | |
| | Pack of 5 | HHC-ARMPULL5 | 8 | 0.7 | \$358 |
| | Pack of 15 | HHC-ARMPULL15 | 23 | 0.7 | \$1001 |

NOTES:

- Pulls are made from 10-gauge steel.
- Mounting hardware included for attaching to steel and wood doors.
- Available in Textured Black and Textured Titanium.
- Available in 5-packs and 15-packs.

WORKPLACE TOOLS

HOW TO SPECIFY

| | |
|---|--|
| Select Model Number HHC-FOOTPULL5 | Select Finish P6P Textured Black P8V Textured Titanium P6P |
|---|--|

SEATING FUNCTIONS

Work/task chairs need to be adjusted to deliver optimum support. Cross-reference the letter key below to identify the chairs in this section that best meet your needs.

PROPORTIONAL ADJUSTMENTS

These controls adapt the dimensions of the chair to fit the user.



A. Pneumatic seat height adjustment — Regulates height of chair relative to floor.

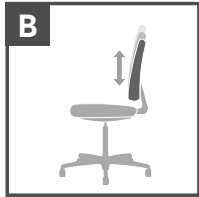

B. Back height adjustment — Positions lumbar support within a fixed range.



C. Seat depth adjustment — Positions chair back relative to seat.

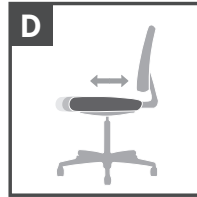

D. Seat slide mechanism — Seat cushion travels forward and back, then locks into position.

ARM OPTIONS

These adjustments accommodate different sized users and support keyboarding.



Q. Adjustable height arms — Provide improved upper-torso support. Can be adjusted periodically to relieve strain and provide variety.

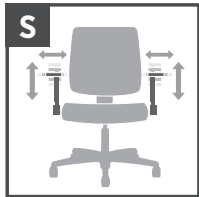

S. Height and width adjustable arms — Controls both height and width of arms for optimum comfort.



T. Loop arms — Largely specified for aesthetics. Frequently used in management settings.

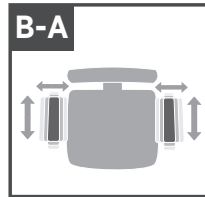

B-A. All-adjustable arms — Arms adjust in height, width, and depth.

POSTURE CONTROLS

The controls modify the position and angle of the seat and back to respond to changing tasks.



E. 360° Swivel

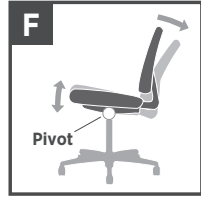

F. Tilt — Pivot point located directly above center of chair base.

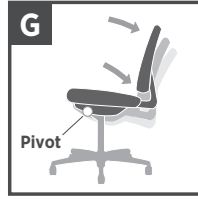

G. Mid-range knee tilt — Pivot point located slightly ahead of center of chair base. Allows user to recline at a slightly more relaxed angle than conventional tilt.

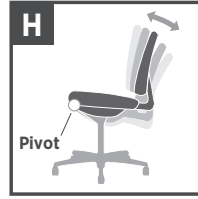

H. Knee tilt — Pivot point located near front edge of chair. Allows user to keep feet flat on floor while chair reclines.

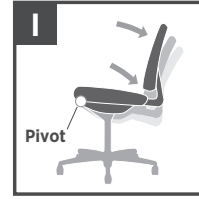

I. Synchronized knee tilt — Back reclines at a 2-to-1 ratio to seat angle. Pivot point located near front edge of chair.

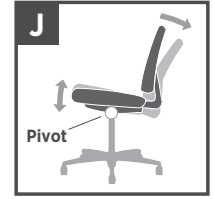

J. Synchro-tilt — Back reclines at a 2-to-1 ratio to seat angle. Allows user to recline while keeping seat cushion relatively level to floor.



K. Tilt tension — Controls rate and ease of recline.



L. Tilt lock — Locks out tilt function.



M. Posture mechanism/lock — Back angle adjusts independently of seat, and can be locked in an infinite number of positions within a fixed range.



N. Multi-task control — Adjusts seat and back angles independently with a single lever (infinite locking within a fixed range).



O. Asynchronous control — High performance system with three levers to modify: angle of back relative to seat, tilt (free float or infinite locking) and forward tilt.

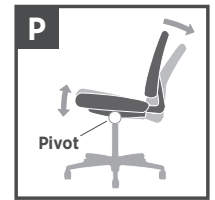

P. Weight-activated synchro-tilt — Back reclines at a 2 to 1 ratio to seat angle. Tilt tension automatically adjusts to user's body weight as user reclines.



W. Integral lumbar support — Easily adjusts to enhance comfort.



X. Dual-clutch posture control — Adjusts seat and back angles independently with two levers (infinite locking within a fixed range).

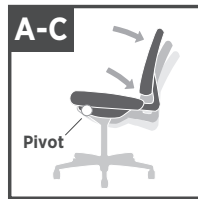

A-C. Synchronized tilt — Back reclines at a 2.5 to 1 ratio to seat angle. Variable lock.

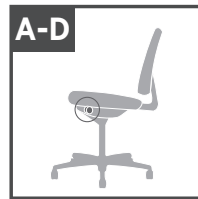

A-D. Side tilt tension — Controls rate and ease of recline. Conveniently located on the right side.



A-E. Back recline — Back reclines at a 2 to 1 ratio to seat angle. Back angle adjusts independently of seat and can be locked in infinite number of positions within a fixed range.

ORDERING INFORMATION

| Seating | Standard Fabric Selections by Series with Price Code and Fabric Material | | | | | | | | | | | | | | | | | | | | | | | | | | | | | | | | | | | |
|--|--|--------|------------------------|--------------------------------|---------------------|----------------------------|-------------|-----------|---------|--------------|------------|--------|----------|----------|---------|-------|--------|-----------------|-------|-------|------|------|------|--------------|---------------|-----------|-------|--------|------|-------|-------------------|---|---|---|---|-------------|
| | 1 | 1 | 1 | 1 | 1 | 1 | 1 | 1 | 1 | 1 | 1 | 1 | 1 | 1 | 1 | 1 | 1 | 2 | 2 | 2 | 2 | 2 | 2 | 2 | 2 | 3 | 3 | 3 | 3 | 3 | L | | | | | |
| Model/Series | APX | AI | EB | VA | GA | MM | EA | CU | COMP | COMF | UR | DAPR | ENSB | HAML | NR | OP | PBLE | PNS | BLME | CLYD | DOT | RUSH | SED | SPNN | WP | ISN | SX | PRKR | PURL | QULL | SS | | | | | |
| | Apex | Attire | Black & Burgundy Vinyl | Black, Charcoal, & Navy Fabric | Black & Navy Fabric | Black Sandwich Mesh Fabric | Black Vinyl | Centurion | Compass | Compass Foam | Contourett | Dapper | Ensemble | Hamilton | Inertia | Optic | Pebble | Appoint Seating | Blume | Clyde | Doty | Rush | Seed | Spin Seating | Whisper Vinyl | In Season | Moxie | Parker | Purl | Quill | Denver Leather*** | | | | | |
| Accommodate® | • | • | | | | | | • | • | | • | • | • | • | • | • | • | • | • | • | • | • | • | • | • | • | • | • | • | • | • | | | | | |
| Adjustable Task/Lab Stool | | | | | | | • | | | | | | | | | | | | | | | | | | | | | | | | | | | | | |
| Astir™ | • | • | | | | | | • | • | | • | • | • | • | • | • | • | • | • | • | • | • | • | • | • | • | • | • | • | • | • | • | | | | |
| Boda™ | | | | | | • | | | | | | | | | | | | | | | | | | | | | | | | | | | | | | |
| Ceres® Series | • | • | | | | | | • | • | | • | • | • | • | • | • | • | • | • | • | • | • | • | • | • | • | • | • | • | • | • | • | | | | |
| Clig™ | • | • | | | | | | • | • | | • | • | • | • | • | • | • | • | • | • | • | • | • | • | • | • | • | • | • | • | • | • | • | | | |
| ComforTask® 5900 Series | • | • | | | | | | • | • | | • | • | • | • | • | • | • | • | • | • | • | • | • | • | • | • | • | • | • | • | • | • | • | | | |
| Convergence® | • | • | | | | | | • | • | | • | • | • | • | • | • | • | • | • | • | • | • | • | • | • | • | • | • | • | • | • | • | • | | | |
| Endorse® Task**** | • | • | | | | | | • | • | | • | • | • | • | • | • | • | • | • | • | • | • | • | • | • | • | • | • | • | • | • | • | • | | | |
| Flock** | • | • | | | | | | • | • | | • | • | • | • | • | • | • | • | • | • | • | • | • | • | • | • | • | • | • | • | • | • | • | | | |
| Flock® Round Lounge HFLRCI/DF and Stool HFSS7 | • | | | | | | | • | • | | • | • | • | • | • | • | • | • | • | • | • | • | • | • | • | • | • | • | • | • | • | • | • | | | |
| Grove® | • | • | | | | | | • | • | | • | • | • | • | • | • | • | • | • | • | • | • | • | • | • | • | • | • | • | • | • | • | • | • | | |
| Ignition® Series | • | • | | | | | | • | • | | • | • | • | • | • | • | • | • | • | • | • | • | • | • | • | • | • | • | • | • | • | • | • | • | | |
| Invitation® Lounge Series | • | • | | | | | | • | • | | • | • | • | • | • | • | • | • | • | • | • | • | • | • | • | • | • | • | • | • | • | • | • | • | | |
| Lota® H2281 / H2285 | | | | • | | | | | | | | | | | | | | | | | | | | | | | | | | | | | | | | |
| Lota® H2282 | • | • | | | | | | • | • | | • | • | • | • | • | • | • | • | • | • | • | • | • | • | • | • | • | • | • | • | • | • | • | • | | |
| Mav™ | • | • | | | | | | • | • | | • | • | • | • | • | • | • | • | • | • | • | • | • | • | • | • | • | • | • | • | • | • | • | • | | |
| Motivate® | • | • | | | | | | • | • | | • | • | • | • | • | • | • | • | • | • | • | • | • | • | • | • | • | • | • | • | • | • | • | • | • | |
| Nucleus® Series | • | • | | | | | | • | • | | • | • | • | • | • | • | • | • | • | • | • | • | • | • | • | • | • | • | • | • | • | • | • | • | • | |
| Pagoda® 4070/4090 Series** | • | • | | | | | | • | • | | • | • | • | • | • | • | • | • | • | • | • | • | • | • | • | • | • | • | • | • | • | • | • | • | • | |
| Perpetual® Nesting | • | • | | | | | | • | • | | • | • | • | • | • | • | • | • | • | • | • | • | • | • | • | • | • | • | • | • | • | • | • | • | • | |
| Pillow-Soft® 2090 Series | • | • | • | | | | | • | • | | • | • | • | • | • | • | • | • | • | • | • | • | • | • | • | • | • | • | • | • | • | • | • | • | • | |
| Solutions Seating® 4000 Series | • | • | | | | | | • | • | | • | • | • | • | • | • | • | • | • | • | • | • | • | • | • | • | • | • | • | • | • | • | • | • | • | |
| Solve® | • | • | | | | | | • | • | • | • | • | • | • | • | • | • | • | • | • | • | • | • | • | • | • | • | • | • | • | • | • | • | • | • | (Seat Only) |
| Soothe® | • | • | | | | | | • | • | | • | • | • | • | • | • | • | • | • | • | • | • | • | • | • | • | • | • | • | • | • | • | • | • | • | |
| Soothe® High-Back | | | | | | | | | | | | | | | | | | | | | | | | | | | • | | | | | | | | | |
| Volt® 5700/5710 Series | | | | | • | | | | | | | | | | | | | | | | | | | | | | | | | | | | | | | |
| Volt® 5720/5730 Series | • | • | | | | | | • | • | | • | • | • | • | • | • | • | • | • | • | • | • | • | • | • | • | • | • | • | • | • | • | • | • | • | • |
| West Hill™ | • | • | | | | | | • | • | | • | • | • | • | • | • | • | • | • | • | • | • | • | • | • | • | • | • | • | • | • | • | • | • | • | • |
| Credenza/Pedestal Cushions | • | • | | | | | | • | • | | • | • | • | • | • | • | • | • | • | • | • | • | • | • | • | • | • | • | • | • | • | • | • | • | • | • |

*Flock® chair model HFLRCI has fabric limitations, please see the Flock® seating pages 288-297 for details.

**Pagoda® wood back models available in Harvest (C), Natural Maple (D), Shaker Cherry (F), Bourbon Cherry (H) and Mahogany (N) only.

***Denver Leather (SS) may not be available on every model within a specific series, please refer to the model's page for details.

****Attire and Pebble available on Endorse® Task as seat option only.

ORDERING INFORMATION

- Seating pages are now arranged in alpha, then numeric, order.
- **All specifications in this publication are based on the latest product information available at the time of print.**
- COM Ordering Information and pricing on page 12.
- Remember to add an FC to the base model number when fire code fabric is selected. See page 216 for available models/fabrics.
- Wood components are well-seasoned select hardwoods, chosen for their strength, their ability to machine well and their superior uniformity of stain and finish.
- Chairs with leather feature matching vinyl backs and vinyl seat bottom when applicable (Non-contact areas are vinyl).

| Wood Seating | Finish Codes | | | | | | | Standard Fabric Selections by Series with Price Code and Fabric Material | | | | | | | | | | | | | | | | | | | |
|-------------------------------------|----------------|--------|---------|----------|-------|---------------|----------|--|----|----|----|------|------|------|----|----|-----|------|-----|------|-----|------|----|-----|------|----|---|
| | | | | | | | | 1 | 1 | 1 | 1 | 1 | 1 | 1 | 1 | 1 | 2 | 2 | 2 | 2 | 2 | 2 | 2 | 2 | 3 | 3 | L |
| Model/Series | Bourbon Cherry | Cognac | Harvest | Mahogany | Mocha | Natural Maple | Pinnacle | Shaker Cherry | AI | EB | CU | COMP | DAPR | HAML | NR | OP | PNS | CLYD | DOT | RUSH | SED | SPNN | WP | ISN | PURL | SS | |
| Cambia™ 2160 Series | H | COGN | C | N | MOCH | D | PINC | F | • | | • | • | • | • | • | • | • | • | • | • | • | • | • | • | • | • | • |
| Invitation® 2110 Series | H | COGN | C | N | MOCH | D | PINC | F | • | | • | • | • | • | • | • | • | • | • | • | • | • | • | • | • | • | • |
| Park Avenue Collection® 5000 Series | H | COGN | C | N | MOCH | D | PINC | F | | | • | • | • | • | • | • | • | • | • | • | • | • | • | | • | • | • |
| Pillow-Soft® 2190 Series | H | COGN | C | N | MOCH | D | PINC | F | | • | • | • | • | • | • | • | • | • | • | • | • | • | • | • | | • | • |
| Versant® Tandem Wood | H | COGN | C | N | MOCH | D | PINC | F | • | | • | • | • | • | • | • | • | • | • | • | • | • | • | • | • | • | • |

Note: Gathers and creases may be more visible with AI and OP fabrics due to the inherent design and construction of these fabrics.

FIRE CODE/COMPLIANT SEATING

FIRE SAFETY

Definitive Protection — CAL TB 117-2013

- TB 117-2013 — The State of California, Department of Consumer Affairs, Bureau of Electronic and Home Appliance Repair, Home Furnishings and Thermal Insulation (BEARHFTI) Technical Bulletin (TB) 117-2013 is the industry flammability standard for upholstered furniture, and provides methods for smolder resistance of cover fabrics, barrier materials, resilient filling materials, and decking materials for use in upholstered furniture.
- The fabrics and resilient filling materials used in upholstered seating manufactured by The HON Company meet or exceed the flame retardant requirements of State of California TB 117-2013. The label attached to the seat bottom indicates compliance with these requirements.

Elevate Fire Safety to a Higher Standard — CAL TB 133

- The State of California announced in January 2019 that Technical Bulletin (TB) 113, The Flammability Test Procedure for Seating Furniture for Use in Public Occupancies has been repealed effective January 22, 2019.
- While the CAL 133 standard has been repealed, a select subset of The HON Company's most popular chair models are still available in an array of fabrics that include an advanced barrier of fire protection to help comply with CAL 133 requirements.
- To ensure that the chairs you order comply with CAL 133, specify one of the fabrics listed below. Then simply add "FC" to the model number when ordering one of the select available models. A standard upcharge of \$90 will be applied per seat model for all single seat chairs.
- **SPECIFYING EXAMPLE: HIWMMFC.Y2.A.H.IM.CU10.NL.SB.T**

MOISTURE BARRIER

- This extra layer of protection prevents moisture from penetrating the foam to improve cleanability and extend product longevity. Moisture barrier is available as an option for the seat only. The recliner gets moisture barrier on seat and footrest.
- **Moisture barrier is not available for the fire code models.**

How to Order

- When specifying Moisture Barrier simply add "MB" to the model number when ordering.

SPECIFYING EXAMPLE: HHCG11MB.S.AI90.P6N.PR8.

Upcharges for Moisture Barrier on Soothe® models

| Model | Moisture Barrier |
|---------|------------------|
| HHCG11 | \$80 |
| HHCG50 | \$120 |
| HHCG21 | \$160 |
| HHCGB21 | \$160 |
| HHCGB31 | \$240 |
| HHCP1 | \$80 |

CAL 133 COMPLIANT MODELS

IGNITION® SEATING

HIEH1FC, HIEH2FC, HIEH3FC, HIWM1FC, HIWM2FC, HIWM3FC, HIWM8FC, HITL1FC, HITL2FC, HITL3FC, HITS5FC, HIGCLFC, HIGS6FC, HISB6FC, HICS7FC, HIB50FC, HITLMFC, HIWMMFC, HITSMFC

MOTIVATE® SEATING

HMN2FC — Available in ONYX (ON) shell only.

NOTES:

- Creases and gathers may be visible with CAL 133 Fire Code seating due to the construction of the fire barrier material used.
- Please refer to each model's page for specific fabric availability.
- Contact HON Tailored Solutions Team for all other requests.

CAL 133 COMPLIANT FABRIC

GRADE 1

| | |
|-------------|-----------|
| AI | Attire |
| APX | Apex |
| COMP | Compass |
| CU | Centurion |
| DAPR | Dapper |
| ENSB | Ensemble |
| HAML | Hamilton |
| NR | Inertia |
| OP | Optic |

GRADE 2

| | |
|-------------|-----------------|
| BLME | Blume |
| CLYD | Clyde |
| DOT | Dotty |
| PNS | Appoint Seating |
| RUSH | Rush |
| SED | Seed |
| SPNN | Spin |
| WP | Whisper Vinyl |

GRADE 3

| | |
|-------------|-----------|
| ISN | In Season |
| PURL | Purl |
| QUL | Quill |

GRADE L

| | |
|-----------|---------|
| SS | Leather |
|-----------|---------|

ACCOMMODATE®

Want to see more? Scan here
to check out hon.com.



Accommodate® Café-Height Stools shown in Centurion Black.

ACCOMMODATE®

The key to designing a collaborative environment is to support productivity throughout the space. From waiting areas and cafés to meeting spaces and offices, Accommodate creates opportunities for people to get work done in a comfortable, casual setting. Cluster together. Form neat rows. Stack four high. With guest and bariatric chairs, as well as café and counter-height stools, Accommodate brings greater comfort, versatility and continuity throughout your space with a seating collection that adapts to your environment, people and budget.



FEATURES

- Thin profile seat cushion conforms to your body.
- Contoured back ergonomically supports the spine.
- Chairs can stack up to four high.
- Chairs can gang together to form neat rows.
- Waterfall seat edge enhances leg circulation.
- Lightweight frame is easy to move.
- Nylon glides slide effortlessly on hard surfaces.
- Tube rolled steel frame adds durability.
- Wall-saver design protects walls and cabinets.
- Warranted for users up to 300 lbs. (Models HSB50 and HSB50DF are warranted for users up to 500 lbs.)
- Available in Seated-, Counter-, and Café-heights.

ACCOMMODATE® Options

MODEL OPTIONS

HSGS6
HSGS6DF - Multi-Fabric



Guest Chair

HSCS1
HSCS1DF - Multi-Fabric



Counter-Height Stool

HSCS2
HSCS2DF - Multi-Fabric



Café-Height Stool

HSB50
HSB50DF - Multi-Fabric

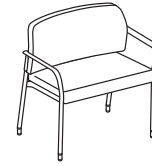

Bariatric Chair

ARM STYLE

| | CODE | DESCRIPTION | PRICE |
|--|----------|-------------|--------------|
| | N | Armless | +\$0 |
| | F | Fixed Arms | +\$30 |

FRAME

| | CODE | DESCRIPTION | PRICE |
|--|-------------|-------------------------|-------------|
| | BLCK | Textured Black Mica | +\$0 |
| | PK7 | Textured Designer White | +\$0 |
| | P7J | Textured Brownstone | +\$0 |
| | P7A | Textured Charcoal | +\$0 |
| | P7L | Textured Loft | +\$0 |
| | P7M | Textured Muslin | +\$0 |
| | PR8 | Textured Silver | +\$0 |
| | P8V | Textured Titanium | +\$0 |

CASTERS/ GLIDES

| | CODE | DESCRIPTION | PRICE |
|--|----------|---|--------------|
| | E | Standard Nylon Glide | +\$0 |
| | H | Black Hard Caster | +\$0 |
| | S | Black All-Surface Caster | +\$20 |
| | B | Both Hard Casters and Standard Nylon Glides | +\$20 |

*Options H, S & B available for HSGS6 and HSGS6DF models only

HON BRANDED FABRICS

| GRADE 1 | GRADE 2 | GRADE 3 |
|------------|-----------------|-----------|
| Apex | Appoint Seating | In Season |
| Attire | Blume | Moxie |
| Centurion | Clyde | Parker |
| Compass | Dotty | Purl |
| Contourett | Rush | Quill |
| Dapper | Seed | |
| Ensemble | Spin | |
| Hamilton | Whisper Vinyl | |
| Inertia | | |
| Optic | | |
| Pebble | | |

For a complete list of fabrics, including partnership fabrics, go to hon.com/fabricsandfinishes.
Reference Fabric Color Combinations on pages 18-22 for color codes and legend on page 19 for lead times.

ACCOMMODATE®

GSA SIN 33721



Icon Legend on page 17

HSGS6

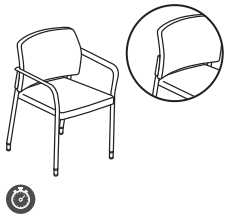

GUEST CHAIR

Set of Two Guest Chairs

DIMENSIONS

| | | | |
|--------------------|-----|--------------------------|----------|
| Depth: | 22¼ | Seat to Floor Height: | 18¼ |
| Height: | 31½ | Usable Seat Depth: | 17 |
| Seat Depth: | 20¾ | Ship Weight (with arms): | 50 |
| Seat Width: | 17½ | Ship Weight (armless): | 48 |
| Back Width: | 19¾ | Cube (with arms): | 15.8 |
| Back Height: | 16¼ | Cube (armless): | 15.8 |
| Width (with arms): | 23½ | COM (per 2 pack): | 3.0 |
| Width (armless): | 19¾ | Weight Rating: | 300 lbs. |
| Arm Width: | 20¼ | | |

FABRIC PRICE CODES

| | | | |
|----------|---------------|-----------|---------------|
| 1 | \$835 | 8 | \$1249 |
| 2 | \$907 | 9 | \$1303 |
| 3 | \$979 | 10 | \$1357 |
| 4 | \$1033 | 11 | \$1411 |
| 5 | \$1087 | 12 | \$1465 |
| 6 | \$1141 | L | — |
| 7 | \$1195 | | |

NOTES: For Ganging Brackets see page 223. Accommodate® Guest Chairs stack 4-high.

HSCS1

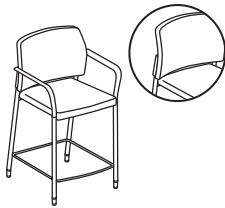

COUNTER-HEIGHT STOOL

DIMENSIONS

| | | | |
|--------------------|-----|--------------------------|----------|
| Depth: | 23½ | Seat to Floor Height: | 25½ |
| Height: | 38¾ | Usable Seat Depth: | 17 |
| Seat Depth: | 20¾ | Ship Weight (with arms): | 36 |
| Seat Width: | 17½ | Ship Weight (armless): | 35 |
| Back Width: | 19¾ | Cube (with arms): | 15.8 |
| Back Height: | 16¼ | Cube (armless): | 15.8 |
| Width (with arms): | 23½ | COM: | 2.0 |
| Width (armless): | 19¾ | Weight Rating: | 300 lbs. |
| Arm Width: | 20¼ | | |

FABRIC PRICE CODES

| | | | |
|----------|--------------|-----------|--------------|
| 1 | \$506 | 8 | \$713 |
| 2 | \$542 | 9 | \$740 |
| 3 | \$578 | 10 | \$767 |
| 4 | \$605 | 11 | \$794 |
| 5 | \$632 | 12 | \$821 |
| 6 | \$659 | L | — |
| 7 | \$686 | | |

HSGANG

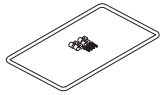

GANGING BRACKET

(hardware included)

DIMENSIONS

Ship Weight: **5** Ⓢ

LIST PRICE

\$37

NOTES: For use on models HSGS6 and HSGS6DF.

! No specification required for bracket. The ganging bracket is only available in black. The ganging bracket does not work on the bariatric unit.

HON Recommendation: HSGS6.N.E.CU__PR8 - List Price \$835

HOW TO SPECIFY

| | | | | |
|--|---|---|--|---|
| <p>Select Model Number</p> <p>H S G S 6 .</p> | <p>Select Arm Type</p> <p>N Armless F Fixed Arms (+ \$30 per chair)</p> <p>N .</p> | <p>Select Caster/Glide</p> <p>E Standard Nylon Glide H Hard Caster S Soft Caster (+ \$20 per chair) B Both Hard Casters and Standard Nylon Glides (+ \$20 per chair) <i>Options H, S & B available for HSGS6 model only</i></p> <p>E .</p> | <p>Select Fabric</p> <p>See page 219</p> <p>C U 1 0 .</p> | <p>Select Frame</p> <p>See page 218</p> <p>P R 8</p> |
|--|---|---|--|---|



ACCOMMODATE®

HSCS2

CAFÉ-HEIGHT STOOL

DIMENSIONS

FABRIC PRICE CODES



| | | | |
|--------------------|-----|--------------------------|----------|
| Depth: | 24½ | Seat to Floor Height: | 31½ |
| Height: | 44¾ | Usable Seat Depth: | 17 |
| Seat Depth: | 20¾ | Ship Weight (with arms): | 38 |
| Seat Width: | 17½ | Ship Weight (armless): | 37 |
| Back Width: | 19¾ | Cube (with arms): | 19.1 |
| Back Height: | 16¼ | Cube (armless): | 19.1 |
| Width (with arms): | 23½ | COM: | 2.0 |
| Width (armless): | 19¾ | Weight Rating: | 300 lbs. |
| Arm Width: | 20¼ | | |

| | | | |
|---|-------|----|-------|
| 1 | \$555 | 8 | \$762 |
| 2 | \$591 | 9 | \$789 |
| 3 | \$627 | 10 | \$816 |
| 4 | \$654 | 11 | \$843 |
| 5 | \$681 | 12 | \$870 |
| 6 | \$708 | L | — |
| 7 | \$735 | | |

HSB50

BARIATRIC CHAIR

DIMENSIONS

FABRIC PRICE CODES

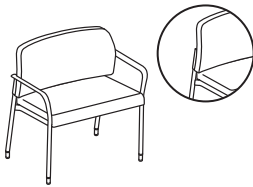

| | | | |
|--------------------|-----|--------------------------|----------|
| Depth: | 21½ | Seat to Floor Height: | 19 |
| Height: | 32½ | Usable Seat Depth: | 16¾ |
| Seat Depth: | 20¼ | Ship Weight (with arms): | 50 |
| Seat Width: | 28 | Ship Weight (armless): | 49 |
| Back Width: | 29 | Cube (with arms): | 27.2 |
| Back Height: | 16½ | Cube (armless): | 27.2 |
| Width (with arms): | 33½ | COM: | 2.0 |
| Width (armless): | 30 | Weight Rating: | 500 lbs. |
| Arm Width: | 30 | | |

| | | | |
|---|--------|----|--------|
| 1 | \$895 | 8 | \$1171 |
| 2 | \$943 | 9 | \$1207 |
| 3 | \$991 | 10 | \$1243 |
| 4 | \$1027 | 11 | \$1279 |
| 5 | \$1063 | 12 | \$1315 |
| 6 | \$1099 | L | — |
| 7 | \$1135 | | |

HON Recommendation: HSCS2.N.E.CU__PR8 - List Price \$555

HOW TO SPECIFY

| | | | | |
|--|---|--|--|---|
| <p>Select Model Number</p> <p>H S C S 2 .</p> | <p>Select Arm Type</p> <p>N Armless F Fixed Arms (+ \$30 per chair)</p> <p>N .</p> | <p>Select Caster/Glide</p> <p>E Standard Nylon Glide</p> <p>E .</p> | <p>Select Fabric</p> <p>See page 219</p> <p>C U 1 0 .</p> | <p>Select Frame</p> <p>See page 218</p> <p>P R 8</p> |
|--|---|--|--|---|

ACCOMMODATE®



Icon Legend on page 17

HSGS6DF

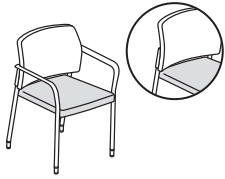

GUEST CHAIR

Multi-Fabric
Set of Two Guest Chairs

DIMENSIONS

| | | | |
|--------------------|--------------------------------|--------------------------|--------------------------------|
| Depth: | 22 ¹ / ₄ | Seat to Floor Height: | 18 ¹ / ₄ |
| Height: | 31 ¹ / ₂ | Usable Seat Depth: | 17 |
| Seat Depth: | 20 ³ / ₄ | Ship Weight (with arms): | 50 |
| Seat Width: | 17 ¹ / ₂ | Ship Weight (armless): | 48 |
| Back Width: | 19 ³ / ₄ | Cube (with arms): | 15.8 |
| Back Height: | 16 ¹ / ₄ | Cube (armless): | 15.8 |
| Width (with arms): | 23 ¹ / ₂ | COM (Seat, per 2 pack): | 1.5 |
| Width (armless): | 19 ³ / ₄ | COM (Back, per 2 pack): | 1.5 |
| Arm Width: | 20 ¹ / ₄ | Weight Rating: | 300 lbs. |

FABRIC PRICE CODES

1 \$1004

Add to Base Price Above

| | Back | Seat |
|-----------|--------------|--------------|
| 2 | \$36 | \$36 |
| 3 | \$72 | \$72 |
| 4 | \$99 | \$99 |
| 5 | \$126 | \$126 |
| 6 | \$153 | \$153 |
| 7 | \$180 | \$180 |
| 8 | \$207 | \$207 |
| 9 | \$234 | \$234 |
| 10 | \$261 | \$261 |
| 11 | \$288 | \$288 |
| 12 | \$315 | \$315 |

NOTES: For Ganging Brackets see page 223. Accommodate® Guest Chairs stack 4-high.

HSCS1DF

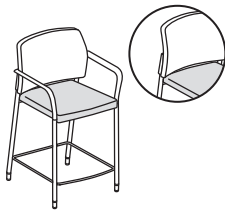

COUNTER-HEIGHT STOOL

Multi-Fabric

DIMENSIONS

| | | | |
|--------------------|--------------------------------|--------------------------|--------------------------------|
| Depth: | 23 ¹ / ₂ | Seat to Floor Height: | 25 ¹ / ₂ |
| Height: | 38 ³ / ₄ | Usable Seat Depth: | 17 |
| Seat Depth: | 20 ³ / ₄ | Ship Weight (with arms): | 36 |
| Seat Width: | 17 ¹ / ₂ | Ship Weight (armless): | 35 |
| Back Width: | 19 ³ / ₄ | Cube (with arms): | 15.8 |
| Back Height: | 16 ¹ / ₄ | Cube (armless): | 15.8 |
| Width (with arms): | 23 ¹ / ₂ | COM (Seat): | 1.0 |
| Width (armless): | 19 ³ / ₄ | COM (Back): | 1.0 |
| Arm Width: | 20 ¹ / ₄ | Weight Rating: | 300 lbs. |

FABRIC PRICE CODES

1 \$594

Add to Base Price Above

| | Back | Seat |
|-----------|--------------|--------------|
| 2 | \$18 | \$18 |
| 3 | \$36 | \$36 |
| 4 | \$50 | \$50 |
| 5 | \$63 | \$63 |
| 6 | \$77 | \$77 |
| 7 | \$90 | \$90 |
| 8 | \$104 | \$104 |
| 9 | \$117 | \$117 |
| 10 | \$131 | \$131 |
| 11 | \$144 | \$144 |
| 12 | \$158 | \$158 |

HON Recommendation: HSGS6DF.N.E.CU__CU__PR8 - List Price \$1004

HOW TO SPECIFY

| Select Model Number | Select Arm Type | Select Caster/Glide | Select Back Fabric | Select Seat Fabric | Select Frame |
|---------------------|---|--|--------------------|--------------------|--------------|
| HSGS6DF | <p>N Armless</p> <p>F Fixed Arms (+ \$30 per chair)</p> | <p>E Standard Nylon Glide</p> <p>H Hard Caster</p> <p>S Soft Caster (+ \$20 per chair)</p> <p>B Both Hard Casters and Standard Nylon Glides (+ \$20 per chair)</p> <p><i>Options H, S & B available for HSGS6DF model only</i></p> | See page 219 | See page 219 | See page 218 |
| | N | E | CU22 | CU10 | PR8 |



ACCOMMODATE®

HSCS2DF



CAFÉ-HEIGHT STOOL

Multi-Fabric

DIMENSIONS

| | | | |
|--------------------|-----|--------------------------|----------|
| Depth: | 24½ | Seat to Floor Height: | 31½ |
| Height: | 44¾ | Usable Seat Depth: | 17 |
| Seat Depth: | 20¾ | Ship Weight (with arms): | 38 |
| Seat Width: | 17½ | Ship Weight (armless): | 37 |
| Back Width: | 19¾ | Cube (with arms): | 19.1 |
| Back Height: | 16¼ | Cube (armless): | 19.1 |
| Width (with arms): | 23½ | COM (Seat): | 1.0 |
| Width (armless): | 19¾ | COM (Back): | 1.0 |
| Arm Width: | 20¼ | Weight Rating: | 300 lbs. |

FABRIC PRICE CODES

| | | |
|--------------------------------|--------------|--------------|
| 1 | \$644 | |
| <i>Add to Base Price Above</i> | | |
| | Back | Seat |
| 2 | \$18 | \$18 |
| 3 | \$36 | \$36 |
| 4 | \$50 | \$50 |
| 5 | \$63 | \$63 |
| 6 | \$77 | \$77 |
| 7 | \$90 | \$90 |
| 8 | \$104 | \$104 |
| 9 | \$117 | \$117 |
| 10 | \$131 | \$131 |
| 11 | \$144 | \$144 |
| 12 | \$158 | \$158 |

HSB50DF

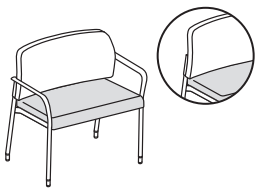

BARIATRIC CHAIR

Multi-Fabric

DIMENSIONS

| | | | |
|--------------------|-----|--------------------------|----------|
| Depth: | 21½ | Seat to Floor Height: | 19 |
| Height: | 32½ | Usable Seat Depth: | 16¾ |
| Seat Depth: | 20¼ | Ship Weight (with arms): | 50 |
| Seat Width: | 28 | Ship Weight (armless): | 49 |
| Back Width: | 29 | Cube (with arms): | 27.2 |
| Back Height: | 16½ | Cube (armless): | 27.2 |
| Width (with arms): | 33½ | COM (Seat): | 1.0 |
| Width (armless): | 30 | COM (Back): | 1.0 |
| Arm Width: | 30 | Weight Rating: | 500 lbs. |

FABRIC PRICE CODES

| | | |
|--------------------------------|--------------|--------------|
| 1 | \$982 | |
| <i>Add to Base Price Above</i> | | |
| | Back | Seat |
| 2 | \$24 | \$24 |
| 3 | \$48 | \$48 |
| 4 | \$66 | \$66 |
| 5 | \$84 | \$84 |
| 6 | \$102 | \$102 |
| 7 | \$120 | \$120 |
| 8 | \$138 | \$138 |
| 9 | \$156 | \$156 |
| 10 | \$174 | \$174 |
| 11 | \$192 | \$192 |
| 12 | \$210 | \$210 |

HSGANG

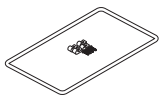

GANGING BRACKET

(hardware included)

DIMENSIONS

Ship Weight: 5 Ⓞ

LIST PRICE

\$37

NOTES: For use on models HSGS6 and HSGS6DF.

ⓘ No specification required for bracket. The ganging bracket is only available in black. The ganging bracket does not work on the bariatric unit.

HON Recommendation: HSCS2DF.N.E.CU__CU__PR8 - List Price \$644

HOW TO SPECIFY

| | | | | | |
|---|---|---|--|--|--|
| Select Model Number H S C S 2 D F . | Select Arm Type N Armless F Fixed Arms (+ \$30) N . | Select Caster/Glide E Standard Nylon Glide E . | Select Back Fabric See page 219 C U 2 2 . | Select Seat Fabric See page 219 C U 1 0 . | Select Frame See page 218 P R 8 |
|---|---|---|--|--|--|

ADJUSTABLE TASK/LAB Stools

OPEN MARKET



Icon Legend on page 17

HMTS01

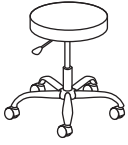

TASK/LAB STOOL

without Back

Pneumatic
Swivel

Functions: **A, E**

(Function Key on pages 212-213)

DIMENSIONS

| | | | |
|---------|----------|-----------------------|----------|
| Depth: | 27¼ | Seat to Floor Height: | 17¾-22 |
| Width: | 24⅝ | Usable Seat Depth: | 16 |
| Height: | 17¾-22 | Ship Weight: | 22 |
| Seat: | 16" Dia. | Cube: | 2.5 |
| | | Weight Rating: | 250 lbs. |

FABRIC PRICE CODE

1 \$397

NOTES: EA vinyl is a healthcare covering that meets AATCC Test Method 147-2004.

ⓘ Available in polished base ONLY. Available in Grade 1, Black, EA11 fabric ONLY.

HMTS11

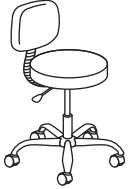

TASK/LAB STOOL

with Back

Pneumatic
Back Height
Seat Depth
Swivel

Functions: **A, B, C, E**

(Function Key on pages 212-213)

DIMENSIONS

| | | | |
|--------------|----------|-----------------------|----------|
| Depth: | 27¼ | Seat to Floor Height: | 17¾-22 |
| Width: | 24⅝ | Usable Seat Depth: | 14¾-16 |
| Height: | 31½-38 | Ship Weight: | 29 |
| Seat: | 16" Dia. | Cube: | 2.7 |
| Back Width: | 15½ | Weight Rating: | 250 lbs. |
| Back Height: | 8¾-16 | | |

FABRIC PRICE CODE

1 \$532

NOTES: EA vinyl is a healthcare covering that meets AATCC Test Method 147-2004.

ⓘ Available in polished base ONLY. Available in Grade 1, Black, EA11 fabric ONLY.

HOW TO SPECIFY

Select
Model Number

H M T S 0 1 .

Select
Fabric

EA11 Black, Grade 1 (only)

E A 1 1



ASSEMBLE™ Nesting/Stacking Chairs

HVL304



NESTING/STACKING

Upholstered Seat and Mesh Back
Casters
Armless
Ships 2 per Carton

DIMENSIONS

| | | | |
|-------------|-----|-----------------------|----------|
| Depth: | 24 | Seat to Floor Height: | 17 |
| Width: | 24 | Usable Seat Depth: | 17 |
| Height: | 34¾ | Ship Weight: | 57 |
| Seat Depth: | 17 | Cube: | 9.0 |
| Seat Width: | 18 | Weight Rating: | 250 lbs. |
| Back Width: | 16¾ | | |

LIST PRICE PER CARTON

\$622
(reference single unit @
\$311.00

NOTES: Stacks 4-high. Comfortable and breathable mesh back. Armless. Black fabric seat. Specify Black (T) or Silver (X) frame. Ships two per carton. **HON 5-Year Limited Warranty.**

fb Mesh Nesting Chairs are ordered and shipped two (2) chairs per carton. Pricing shown is per carton. Each set of two chairs (one carton) must have the same fabric/frame color. Ordering 2 of any model will result in 2 cartons being shipped, giving you 4 chairs.

HON Recommendation: HVL304.VA10.T - List Price \$622

HVL314



NESTING/STACKING

Upholstered Seat and Mesh Back
Casters
Arms
Ships 2 per Carton

DIMENSIONS

| | | | |
|-------------|-----|-----------------------|----------|
| Depth: | 24 | Arm Width: | 18 |
| Width: | 24 | Seat to Floor Height: | 17 |
| Height: | 34¾ | Usable Seat Depth: | 17 |
| Seat Depth: | 17 | Ship Weight: | 57 |
| Seat Width: | 18 | Cube: | 9.2 |
| Back Width: | 16¾ | Weight Rating: | 250 lbs. |

LIST PRICE PER CARTON

\$649
(reference single unit @
\$324.50

NOTES: Stacks 4-high. Comfortable and breathable mesh back. With arms. Black fabric seat. Specify Black (T) or Silver (X) frame. Ships two per carton. **HON 5-Year Limited Warranty.**

fb Mesh Nesting Chairs are ordered and shipped two (2) chairs per carton. Pricing shown is per carton. Each set of two chairs (one carton) must have the same fabric/frame color. Ordering 2 of any model will result in 2 cartons being shipped, giving you 4 chairs.

HON Recommendation: HVL314.VA10.T - List Price \$649

HOW TO SPECIFY

Select Model Number

HVL304

Select Fabric

VA10 Black

VA10

Select Frame

T Black
X Silver

T

ASTIR™ COLLABORATIVE WORK SEATING

Want to see more?
Scan here to check
out hcn.com.



Astir™ Collaborative Work Seating shown with Birk™ Tables and Acoustic Solutions by Unika Vaev.

ASTIR™

Astir™ Collaborative Work answers the call for soft seating solutions while providing separate work spaces and sturdy posture support for those looking to step away from their desks. The line provides a soft yet upright sit to keep employees engaged and working comfortably at a table setting. High back and side options help keep private conversations private — so teams don't have to be confined in close quarters, such as a conference room. And a unique, single-seat style with high screens on three sides creates a quiet, secure and comfortable space for individual focus.



FEATURES

- Seat height and back angle are scaled for more of an upright working posture.
- Choose from One+, Two- or Three-Seat Lounges in low- or high-back options.
- High-back screens available in knit mesh or fabric options and provide visual privacy on back and sides.
- Fabric high-back screen option available in cleanable fabrics (see HON's cleaning guide for instructions).
- Choose from three different leg styles to customize your look.
- Two- or Three-Seat Benches add extra seating for commons or reception areas.
- Pouf model functions as both impromptu seating and a place to kick up your feet.
- Replaceable seat cushion enhances comfort and cleanability, and allows for easy changing.
- With the multi-fabric options, seat cushion and frame can be specified in different fabrics for a modern aesthetic.
- Add an optional power module to route power directly underneath the seat.

MODEL OPTIONS

**HASLB1, HASLB1MF -
Multi-Fabric**



Lounge
One+ Seat, Low-Back

**HASLB2, HASLB2MF -
Multi-Fabric**

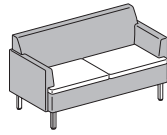

Lounge
Two-Seat, Low-Back

**HASLB3, HASLB3MF -
Multi-Fabric**

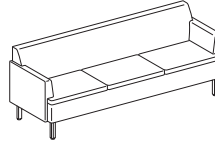

Lounge
Three-Seat, Low-Back

**HASLBTC, HASLBTCMF -
Multi-Fabric**

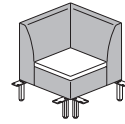

Lounge
True Corner, Low-Back

**HASHB1, HASHB1MF -
Multi-Fabric**

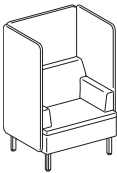

Lounge
One+ Seat, High-Back Screen

**HASHB2, HASHB2MF -
Multi-Fabric**

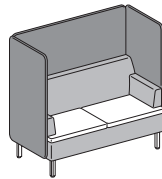

Lounge
Two-Seat, High-Back Screen

**HASHB3, HASHB3MF -
Multi-Fabric**

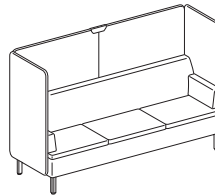

Lounge
Three-Seat, High-Back Screen

**HASHBTC, HASHBTCMF -
Multi-Fabric**

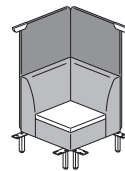

Lounge
True Corner, High-Back Screen

**HASB2, HASB2MF -
Multi-Fabric**

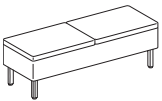

Bench
Two-Seat Bench

**HASB3, HASB3MF -
Multi-Fabric**

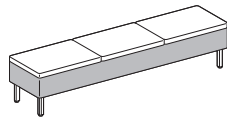

Bench
Three-Seat Bench

**HASPSS, HASPSSMF -
Multi-Fabric**



Pouf

Low-Back, Multi-Fabric



High-Back, Multi-Fabric



ASTIR™ Finish Options

HON BRANDED FABRICS

| GRADE 1 | GRADE 2 | GRADE 3 | KNIT |
|------------|-----------------|---------|--------|
| Apex | Appoint Seating | Moxie | Light |
| Centurion | Blume | Purl | Medium |
| Contourett | Clyde | Quill | Dark |
| Dapper | Rush | | |
| Ensemble | Seed | | |
| Hamilton | Whisper Vinyl | | |
| Inertia | | | |
| Pebble | | | |

SCREEN FABRIC OPTIONS

| FABRICS |
|---------------|
| Apex |
| Blume |
| Contourett |
| Moxie |
| Pebble |
| Whisper Vinyl |

LEG STYLE

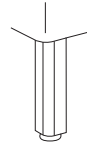

| CODE | DESCRIPTION | PRICE |
|---|--------------------|--------------|
| PM | Post Metal | +\$50 |
| <i>Available in the following finishes:</i> | | |
| P8V | Textured Titanium | |
| P7A | Textured Charcoal | |
| P8X | Solar Black | +\$20 |
| PR5 | Champagne Metallic | +\$20 |

For a complete list of fabrics, including partnership fabrics, go to hon.com/fabricsandfinishes.

Reference Fabric Color Combinations on pages 18-22 for color codes and legend on page 19 for lead times.

LEG STYLE

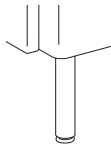

| CODE | DESCRIPTION | PRICE |
|---|------------------|-------------|
| DW | Dowel Wood | +\$0 |
| <i>Available in the following finishes:</i> | | |
| LFW1 | Florence Walnut | |
| LKI1 | Kingswood Walnut | |
| LLA1 | Lowell Ash | |
| D | Natural Maple | |
| LNRI | Natural Recon | |
| LPE1 | Phantom Ecru | |
| PINC | Pinnacle | |
| LPT1 | Portico Teak | |
| LSW1 | Skyline Walnut | |
| LSA1 | Sterling Ash | |

LEG STYLE

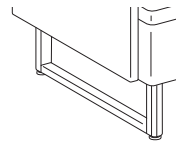

| CODE | DESCRIPTION | PRICE |
|---|------------------|---------------|
| SW | Sled Wood | +\$100 |
| <i>Available in the following finishes:</i> | | |
| LFW1 | Florence Walnut | |
| LKI1 | Kingswood Walnut | |
| LLA1 | Lowell Ash | |
| D | Natural Maple | |
| LNRI | Natural Recon | |
| LPE1 | Phantom Ecru | |
| PINC | Pinnacle | |
| LPT1 | Portico Teak | |
| LSW1 | Skyline Walnut | |
| LSA1 | Sterling Ash | |

MULTI-FABRIC COM YARDAGE

Due to fabric pattern nesting and potential reduction of fabric yield, some multi-fabric models may require more total yardage than standard models.

| MODEL | COM (ARMLESS) | | | COM (ONE ARM/SIDE) | | | COM (BOTH ARMS/SIDES) | | |
|-----------|---------------|------------|--------|--------------------|------------|--------|-----------------------|------------|--------|
| | Seat | Back/Frame | Screen | Seat | Back/Frame | Screen | Seat | Back/Frame | Screen |
| HASLB1 | — | — | — | — | — | — | 6.5 | — | — |
| HASLB1MF | — | — | — | — | — | — | 1.5 | 5.0 | — |
| HASLBTC | — | 5.0 | — | — | — | — | — | — | — |
| HASLBTCMF | 1.5 | 4.0 | — | — | — | — | — | — | — |
| HASLB2 | — | 7.0 | — | — | 8.0 | — | — | 9.0 | — |
| HASLB2MF | 3.0 | 4.5 | — | 3.0 | 5.5 | — | 3.0 | 6.5 | — |
| HASLB3 | — | 10.0 | — | — | 11.0 | — | — | 12.0 | — |
| HASLB3MF | 4.0 | 6.0 | — | 4.0 | 7.5 | — | 4.0 | 8.5 | — |
| HASHB1 | — | — | — | — | — | — | — | 4.5 | 8.0 |
| HASHB1MF | — | — | — | — | — | — | 1.5 | 3.5 | 8.0 |
| HASHBTC | — | 5.0 | 5.5 | — | — | — | — | — | — |
| HASHBTCMF | 1.5 | 4.0 | 5.5 | — | — | — | — | — | — |
| HASHB2 | — | 7.0 | 5.5 | — | 7.0 | 8.0 | — | 7.0 | 11.0 |
| HASHB2MF | 3.0 | 4.5 | 5.5 | 3.0 | 4.5 | 8.0 | 3.0 | 4.5 | 11.0 |
| HASHB3 | — | 10.5 | 5.5 | — | 10.5 | 8.0 | — | 10.5 | 11.0 |
| HASHB3MF | 4.0 | 7.0 | 5.5 | 4.0 | 7.0 | 8.0 | 4.0 | 7.0 | 11.0 |
| HASPSS | — | 2.0 | — | — | — | — | — | — | — |
| HASPSSMF | 1.0 | 1.5 | — | — | — | — | — | — | — |
| HASB2 | — | 4.5 | — | — | — | — | — | — | — |
| HASB2MF | 3.0 | 2.0 | — | — | — | — | — | — | — |
| HASB3 | — | 6.5 | — | — | — | — | — | — | — |
| HASB3MF | 4.0 | 2.5 | — | — | — | — | — | — | — |



HASLB1

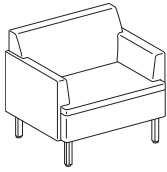

ONE+ SEAT — LOW-BACK

DIMENSIONS

| | | | |
|-----------------------|-----|----------------|--------------|
| Depth: | 29 | Back Height: | 16 |
| Height: | 32 | Back Width: | 33½ |
| Width: | 36½ | Arm Height: | 7½ |
| Usable Seat Depth: | 19¾ | Ship Weight: | 95 |
| Seat to Floor Height: | 18¾ | Cube: | 21.2 |
| Seat Width: | 27 | COM: | See page 228 |
| | | Weight Rating: | 300 lbs. |

FABRIC PRICE CODES

| | | | |
|---|--------|----|--------|
| 1 | \$2099 | 8 | \$3277 |
| 2 | \$2255 | 9 | \$3306 |
| 3 | \$2414 | 10 | \$3465 |
| 4 | \$2546 | 11 | \$3624 |
| 5 | \$2723 | 12 | \$3784 |
| 6 | \$2903 | L | — |
| 7 | \$3088 | | |

HASLB1MF

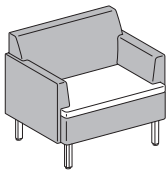

ONE+ SEAT — LOW-BACK, MULTI-FABRIC

DIMENSIONS

| | | | |
|-----------------------|-----|----------------|--------------|
| Depth: | 29 | Back Height: | 16 |
| Height: | 32 | Back Width: | 33½ |
| Width: | 36½ | Arm Height: | 7½ |
| Usable Seat Depth: | 19¾ | Ship Weight: | 95 |
| Seat to Floor Height: | 18¾ | Cube: | 21.2 |
| Seat Width: | 27 | COM: | See page 228 |
| | | Weight Rating: | 300 lbs. |

FABRIC PRICE CODES

| | | | |
|--------------------------------|-------------|-------------------|--|
| 1 | \$2258 | | |
| <i>Add to Base Price Above</i> | | | |
| | Seat | Frame/Back | |
| 2 | \$36 | \$120 | |
| 3 | \$73 | \$242 | |
| 4 | \$103 | \$344 | |
| 5 | \$144 | \$480 | |
| 6 | \$186 | \$619 | |
| 7 | \$228 | \$761 | |
| 8 | \$272 | \$906 | |
| 9 | \$279 | \$929 | |
| 10 | \$315 | \$1051 | |
| 11 | \$352 | \$1173 | |
| 12 | \$389 | \$1296 | |

HON Recommendation: HASLB1.B.PURL__DW__ - List Price \$2414

HOW TO SPECIFY

| | | | | | |
|---|---|---|---|---|--|
| <p>Select Model Number</p> <p>HASLB1MF .</p> | <p>Select Arm Type</p> <p>B Both Arms</p> <p>B .</p> | <p>Select Fabric</p> <p>See page 228 <i>Specify for Single Fabric model only</i></p> <p>PBLE07 .</p> | <p>Select Seat Cushion Fabric</p> <p>See page 228 <i>Specify for MF model only</i></p> <p>PBLE09 .</p> | <p>Select Back and Frame Fabric</p> <p>See page 228 <i>Specify for MF model only</i></p> <p>PBLE06 .</p> | <p>Select Leg and Color</p> <p>DW Dowel Wood PM Post Metal (+ \$50) SW Sled Wood (+ \$100) See page 228 for colors</p> <p>PMP8V</p> |
|---|---|---|---|---|--|

ASTIR™ Collaborative Work Seating

OPEN MARKET



Icon Legend on page 17

HASHB1

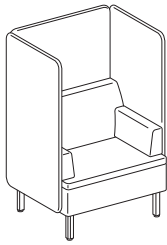

ONE+ SEAT — HIGH-BACK SCREEN

DIMENSIONS

| | | | |
|-----------------------|-----|----------------|--------------|
| Depth: | 29¾ | Back Height: | 16 |
| Height: | 54 | Back Width: | 33½ |
| Width: | 35 | Arm Height: | 7½ |
| Usable Seat Depth: | 19¾ | Ship Weight*: | 124 |
| Seat to Floor Height: | 18¾ | Cube: | 24.1 |
| Seat Width: | 25½ | COM: | See page 228 |
| | | Weight Rating: | 300 lbs. |

FABRIC PRICE CODES

1 \$2890

Add to Base Price Above

| | Unit | Knit | Screen |
|----|--------|------|--------|
| 1 | — | 1 | \$150 |
| 2 | \$120 | 2 | \$342 |
| 3 | \$242 | 3 | \$538 |
| 4 | \$344 | 4 | \$700 |
| 5 | \$480 | 5 | \$918 |
| 6 | \$619 | 6 | \$1140 |
| 7 | \$761 | 7 | \$1367 |
| 8 | \$906 | 8 | \$1600 |
| 9 | \$929 | 9 | \$1636 |
| 10 | \$1051 | 10 | \$1832 |
| 11 | \$1173 | 11 | \$2028 |
| 12 | \$1296 | 12 | \$2223 |

*Ships in two cartons.

HASHB1MF

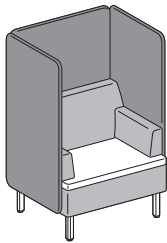

ONE+ SEAT — HIGH-BACK SCREEN, MULTI-FABRIC

DIMENSIONS

| | | | |
|-----------------------|-----|----------------|--------------|
| Depth: | 29¾ | Back Height: | 16 |
| Height: | 54 | Back Width: | 33½ |
| Width: | 35 | Arm Height: | 7½ |
| Usable Seat Depth: | 19¾ | Ship Weight*: | 124 |
| Seat to Floor Height: | 18¾ | Cube: | 24.1 |
| Seat Width: | 25½ | COM: | See page 228 |
| | | Weight Rating: | 300 lbs. |

FABRIC PRICE CODES

1 \$3050

Add to Base Price Above

| | Seat | Back/ Frame | Knit | Screen |
|----|-------|----------------|------|--------|
| 1 | — | — | 1 | \$150 |
| 2 | \$36 | \$96 | 2 | \$342 |
| 3 | \$73 | \$194 | 3 | \$538 |
| 4 | \$103 | \$275 | 4 | \$700 |
| 5 | \$144 | \$384 | 5 | \$918 |
| 6 | \$186 | \$495 | 6 | \$1140 |
| 7 | \$228 | \$609 | 7 | \$1367 |
| 8 | \$272 | \$725 | 8 | \$1600 |
| 9 | \$279 | \$743 | 9 | \$1636 |
| 10 | \$315 | \$841 | 10 | \$1832 |
| 11 | \$352 | \$939 | 11 | \$2028 |
| 12 | \$389 | \$1037 | 12 | \$2223 |

*Ships in two cartons.

HON Recommendation: HASHB1.B.PURL__KMD.DW__ - List Price \$3132

SEATING

HOW TO SPECIFY

| Select Model Number | Select Arm Type | Select Fabric | Select Seat Cushion Fabric | Select Back and Frame Fabric | Select Screen Knit or Fabric | Select Leg and Color |
|---------------------|---------------------|--|---|---|--|--|
| | B Both Side Screens | See page 228 Specify for Single Fabric model only | See page 228 Specify for MF model only | See page 228 Specify for MF model only | Knit Options: KLT Light KMD Medium KDK Dark See page 228 for all options | DW Dowel Wood PM Post Metal (+ \$50) SW Sled Wood (+ \$100) See page 228 for colors |
| H A S H B 1 M F . | B . | P B L E 0 7 . | P B L E 0 9 . | P B L E 0 6 . | K M D . | P M P 8 V |



ASTIR™ Collaborative Work Seating

HASLB2

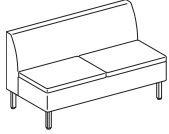

Armless

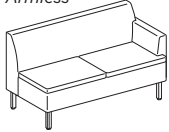

Left

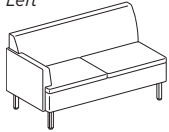

Right

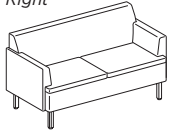

Both Arms

TWO-SEAT LOUNGE — LOW-BACK

DIMENSIONS

| | | | |
|-------------------------|-----|--------------------------|---------------------|
| Depth: | 29 | Back Height: | 16 |
| Height: | 32 | Back Width: | 56½ |
| Width (armless): | 56½ | Arm Height: | 7½ |
| Width (one arm): | 58 | Ship Weight (armless): | 113 |
| Width (both arms): | 59½ | Ship Weight (one arm): | 122 |
| Usable Seat Depth: | 19¾ | Ship Weight (both arms): | 131 |
| Seat to Floor Height: | 18¾ | Cube: | 35.1 |
| Seat Width (armless): | 56½ | COM: | See page 228 |
| Seat Width (one arm): | 53¼ | | 228 |
| Seat Width (both arms): | 50 | Weight Rating: | 300 lbs. (per seat) |

FABRIC PRICE CODES

| | | | |
|---|--------|----|--------|
| 1 | \$2343 | 8 | \$3974 |
| 2 | \$2558 | 9 | \$4014 |
| 3 | \$2779 | 10 | \$4235 |
| 4 | \$2962 | 11 | \$4455 |
| 5 | \$3207 | 12 | \$4676 |
| 6 | \$3457 | L | — |
| 7 | \$3713 | | |

HASLB2MF

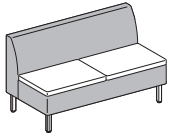

Armless

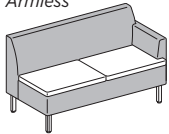

Left

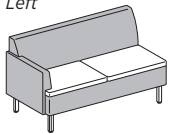

Right

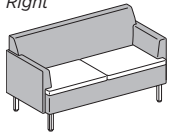

Both Arms

TWO-SEAT LOUNGE — LOW-BACK, MULTI-FABRIC

DIMENSIONS

| | | | |
|-------------------------|-----|--------------------------|---------------------|
| Depth: | 29 | Back Height: | 16 |
| Height: | 32 | Back Width: | 56½ |
| Width (armless): | 56½ | Arm Height: | 7½ |
| Width (one arm): | 58 | Ship Weight (armless): | 113 |
| Width (both arms): | 59½ | Ship Weight (one arm): | 122 |
| Usable Seat Depth: | 19¾ | Ship Weight (both arms): | 131 |
| Seat to Floor Height: | 18¾ | Cube: | 35.1 |
| Seat Width (armless): | 56½ | COM: | See page 228 |
| Seat Width (one arm): | 53¼ | | 228 |
| Seat Width (both arms): | 50 | Weight Rating: | 300 lbs. (per seat) |

FABRIC PRICE CODES

| | | | |
|--------------------------------|--------|-------------|-------------------|
| 1 | \$2502 | | |
| <i>Add to Base Price Above</i> | | | |
| | | Seat | Frame/Back |
| 2 | \$72 | \$156 | \$156 |
| 3 | \$145 | \$315 | \$315 |
| 4 | \$206 | \$447 | \$447 |
| 5 | \$288 | \$624 | \$624 |
| 6 | \$371 | \$804 | \$804 |
| 7 | \$457 | \$989 | \$989 |
| 8 | \$544 | \$1178 | \$1178 |
| 9 | \$557 | \$1207 | \$1207 |
| 10 | \$631 | \$1366 | \$1366 |
| 11 | \$704 | \$1525 | \$1525 |
| 12 | \$778 | \$1685 | \$1685 |

HON Recommendation: HASLB2.B.PURL__DW__ - List Price \$3229

HOW TO SPECIFY

| | | | | | |
|--|---|--|--|--|---|
| Select Model Number HASLB2MF | Select Arm Type N Armless L Left Side (+ \$225) R Right Side (+ \$225) B Both Arms (+ \$450) | Select Fabric See page 228 Specify for Single Fabric model only | Select Seat Cushion Fabric See page 228 Specify for MF model only | Select Back and Frame Fabric See page 228 Specify for MF model only | Select Leg and Color DW Dowel Wood PM Post Metal (+ \$50) SW Sled Wood (+ \$100) See page 228 for colors |
| | B | PBLE07 | PBLE09 | PBLE06 | PMP8V |

SEATING

ASTIR™ Collaborative Work Seating

OPEN MARKET



Icon Legend on page 17

HASHB2

TWO-SEAT LOUNGE — HIGH-BACK SCREEN

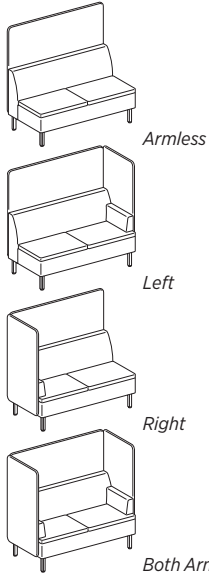

DIMENSIONS

| | | | |
|-------------------------|-----|---------------------------|---------------------|
| Depth: | 29¾ | Back Height: | 16 |
| Height: | 54 | Back Width: | 56½ |
| Width (armless): | 56½ | Arm Height: | 7½ |
| Width (one arm): | 57¼ | Ship Weight* (armless): | 136 |
| Width (both arms): | 58 | Ship Weight* (one arm): | 156 |
| Usable Seat Depth: | 19¾ | Ship Weight* (both arms): | 176 |
| Seat to Floor Height: | 18¾ | Cube: | 29.4 |
| Seat Width (armless): | 56½ | COM: | See page 228 |
| Seat Width (one arm): | 52¼ | Weight Rating: | 300 lbs. (per seat) |
| Seat Width (both arms): | 48¼ | | |

FABRIC PRICE CODES

1 \$3329

Add to Base Price Above

| | Unit | Knit | Screen |
|--|------|------|--------|
| | 1 | 1 | \$150 |
| | 2 | 2 | \$413 |
| | 3 | 3 | \$683 |
| | 4 | 4 | \$906 |
| | 5 | 5 | \$1206 |
| | 6 | 6 | \$1511 |
| | 7 | 7 | \$1824 |
| | 8 | 8 | \$2143 |
| | 9 | 9 | \$2193 |
| | 10 | 10 | \$2462 |
| | 11 | 11 | \$2732 |
| | 12 | 12 | \$3001 |

*Ships in two cartons.

HASHB2MF

TWO-SEAT LOUNGE — HIGH-BACK SCREEN, MULTI-FABRIC

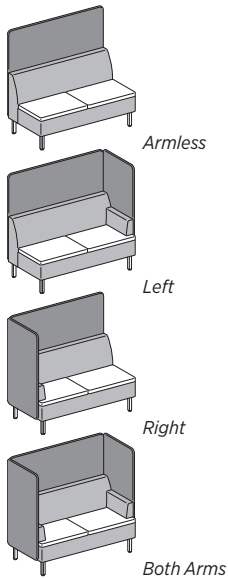

DIMENSIONS

| | | | |
|-------------------------|-----|---------------------------|---------------------|
| Depth: | 29¾ | Back Height: | 16 |
| Height: | 54 | Back Width: | 56½ |
| Width (armless): | 56½ | Arm Height: | 7½ |
| Width (one arm): | 57¼ | Ship Weight* (armless): | 136 |
| Width (both arms): | 58 | Ship Weight* (one arm): | 156 |
| Usable Seat Depth: | 19¾ | Ship Weight* (both arms): | 176 |
| Seat to Floor Height: | 18¾ | Cube: | 29.4 |
| Seat Width (armless): | 56½ | COM: | See page 228 |
| Seat Width (one arm): | 52¼ | Weight Rating: | 300 lbs. (per seat) |
| Seat Width (both arms): | 48¼ | | |

FABRIC PRICE CODES

1 \$3489

Add to Base Price Above

| | Seat | Back/Frame | Knit | Screen | |
|--|------|------------|--------|--------|--------|
| | 1 | — | 1 | \$150 | |
| | 2 | \$72 | \$120 | 2 | \$413 |
| | 3 | \$145 | \$242 | 3 | \$683 |
| | 4 | \$206 | \$344 | 4 | \$906 |
| | 5 | \$288 | \$480 | 5 | \$1206 |
| | 6 | \$371 | \$619 | 6 | \$1511 |
| | 7 | \$457 | \$761 | 7 | \$1824 |
| | 8 | \$544 | \$906 | 8 | \$2143 |
| | 9 | \$557 | \$929 | 9 | \$2193 |
| | 10 | \$631 | \$1051 | 10 | \$2462 |
| | 11 | \$704 | \$1173 | 11 | \$2732 |
| | 12 | \$778 | \$1296 | 12 | \$3001 |

*Ships in two cartons.

HON Recommendation: HASHB2.B.PURL__KMD.DW__ - List Price \$4617

HOW TO SPECIFY

| Select Model Number | Select Arm Type | Select Fabric | Select Seat Cushion Fabric | Select Back and Frame Fabric | Select Screen Knit or Fabric | Select Leg and Color |
|---------------------|---|--|---|---|---|---|
| HASHB2MF | <ul style="list-style-type: none"> N Armless L Left Side (+ \$450) R Right Side (+ \$450) B Both Side Screens (+ \$900) | See page 228 Specify for Single Fabric model only | See page 228 Specify for MF model only | See page 228 Specify for MF model only | Knit Options: KLT Light KMD Medium KDK Dark See page 228 for all options | DW Dowel Wood PM Post Metal (+ \$50) SW Sled Wood (+ \$100) See page 228 for colors |
| | B | PBLE07 | PBLE09 | PBLE06 | KMD | PMP8V |



ASTIR™ Collaborative Work Seating

HASLB3

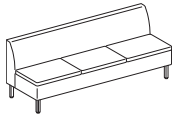

Armless

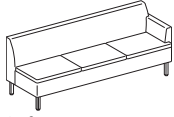

Left

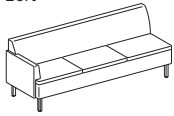

Right

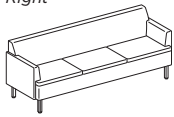

Both Arms

THREE-SEAT LOUNGE — LOW-BACK

DIMENSIONS

| | | | |
|-------------------------|-----|--------------------------|---------------------|
| Depth: | 29 | Back Height: | 16 |
| Height: | 32 | Back Width: | 84½ |
| Width (armless): | 84½ | Arm Height: | 7½ |
| Width (one arm): | 86 | Ship Weight (armless): | 152 |
| Width (both arms): | 87½ | Ship Weight (one arm): | 161 |
| Usable Seat Depth: | 19¾ | Ship Weight (both arms): | 170 |
| Seat to Floor Height: | 18¾ | Cube: | 47.9 |
| Seat Width (armless): | 84½ | COM: | See page 228 |
| Seat Width (one arm): | 81¼ | | 228 |
| Seat Width (both arms): | 78 | Weight Rating: | 300 lbs. (per seat) |

FABRIC PRICE CODES

| | | | |
|---|--------|----|--------|
| 1 | \$3096 | 8 | \$5270 |
| 2 | \$3383 | 9 | \$5325 |
| 3 | \$3678 | 10 | \$5618 |
| 4 | \$3921 | 11 | \$5912 |
| 5 | \$4248 | 12 | \$6206 |
| 6 | \$4581 | L | — |
| 7 | \$4922 | | |

HASLB3MF

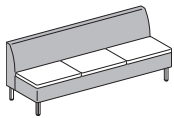

Armless

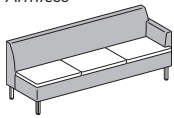

Left

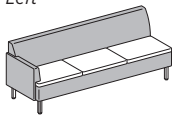

Right

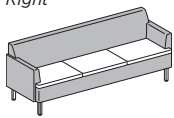

Both Arms

THREE-SEAT LOUNGE — LOW-BACK, MULTI-FABRIC

DIMENSIONS

| | | | |
|-------------------------|-----|--------------------------|---------------------|
| Depth: | 29 | Back Height: | 16 |
| Height: | 32 | Back Width: | 84½ |
| Width (armless): | 84½ | Arm Height: | 7½ |
| Width (one arm): | 86 | Ship Weight (armless): | 152 |
| Width (both arms): | 87½ | Ship Weight (one arm): | 161 |
| Usable Seat Depth: | 19¾ | Ship Weight (both arms): | 170 |
| Seat to Floor Height: | 18¾ | Cube: | 47.9 |
| Seat Width (armless): | 84½ | COM: | See page 228 |
| Seat Width (one arm): | 81¼ | | 228 |
| Seat Width (both arms): | 78 | Weight Rating: | 300 lbs. (per seat) |

FABRIC PRICE CODES

| | | | |
|--------------------------------|-------------|-------------------|--|
| 1 | \$3255 | | |
| <i>Add to Base Price Above</i> | | | |
| | Seat | Frame/Back | |
| 2 | \$96 | \$203 | |
| 3 | \$194 | \$412 | |
| 4 | \$275 | \$584 | |
| 5 | \$384 | \$816 | |
| 6 | \$495 | \$1052 | |
| 7 | \$609 | \$1293 | |
| 8 | \$725 | \$1540 | |
| 9 | \$743 | \$1579 | |
| 10 | \$841 | \$1787 | |
| 11 | \$939 | \$1995 | |
| 12 | \$1037 | \$2203 | |

HON Recommendation: HASLB3.B.PURL__DW__ - List Price \$4128

HOW TO SPECIFY

| | | | | | |
|--|---|--|--|--|---|
| Select Model Number HASLB3MF | Select Arm Type N Armless L Left Side (+ \$225) R Right Side (+ \$225) B Both Arms (+ \$450) | Select Fabric See page 228 Specify for Single Fabric model only | Select Seat Cushion Fabric See page 228 Specify for MF model only | Select Back and Frame Fabric See page 228 Specify for MF model only | Select Leg and Color DW Dowel Wood PM Post Metal (+ \$50) SW Sled Wood (+ \$100) See page 228 for colors |
| HASLB3MF | B | PBLE07 | PBLE09 | PBLE06 | PMP8V |

SEATING

ASTIR™ Collaborative Work Seating

OPEN MARKET



Icon Legend on page 17

HASHB3

THREE-SEAT LOUNGE — HIGH-BACK SCREEN

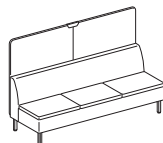

Armless

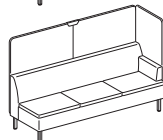

Left



Right

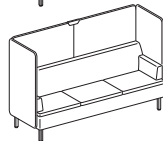

Both Arms

*Ships in two cartons.

DIMENSIONS

| | | | |
|-------------------------|-----|---------------------------|---------------------|
| Depth: | 29¾ | Back Height: | 16 |
| Height: | 54 | Back Width: | 84½ |
| Width (armless): | 84½ | Arm Height: | 7½ |
| Width (one arm): | 85¼ | Ship Weight* (armless): | 185 |
| Width (both arms): | 86 | Ship Weight* (one arm): | 205 |
| Usable Seat Depth: | 19¾ | Ship Weight* (both arms): | 225 |
| Seat to Floor Height: | 18¾ | Cube: | 39 |
| Seat Width (armless): | 84½ | COM: | See page 228 |
| Seat Width (one arm): | 80½ | Weight Rating: | 300 lbs. (per seat) |
| Seat Width (both arms): | 76½ | | |

FABRIC PRICE CODES

| | | | |
|-------------------------|---------------|---------------|---------------|
| 1 | | \$4548 | |
| Add to Base Price Above | | | |
| | Unit | Knit | Screen |
| | 1 | 1 | \$150 |
| 1 | — | 2 | \$413 |
| 2 | \$251 | 3 | \$683 |
| 3 | \$509 | 4 | \$906 |
| 4 | \$722 | 5 | \$1206 |
| 5 | \$1008 | 6 | \$1511 |
| 6 | \$1300 | 7 | \$1824 |
| 7 | \$1598 | 8 | \$2143 |
| 8 | \$1903 | 9 | \$2193 |
| 9 | \$1950 | 10 | \$2462 |
| 10 | \$2207 | 11 | \$2732 |
| 11 | \$2464 | 12 | \$3001 |
| 12 | \$2721 | | |

HASHB3MF

THREE-SEAT LOUNGE — HIGH-BACK SCREEN, MULTI-FABRIC

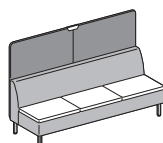

Armless

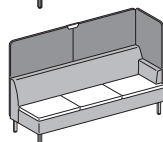

Left

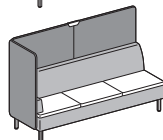

Right

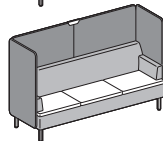

Both Arms

*Ships in two cartons.

DIMENSIONS

| | | | |
|-------------------------|-----|---------------------------|---------------------|
| Depth: | 29¾ | Back Height: | 16 |
| Height: | 54 | Back Width: | 84½ |
| Width (armless): | 84½ | Arm Height: | 7½ |
| Width (one arm): | 85¼ | Ship Weight* (armless): | 185 |
| Width (both arms): | 86 | Ship Weight* (one arm): | 205 |
| Usable Seat Depth: | 19¾ | Ship Weight* (both arms): | 225 |
| Seat to Floor Height: | 18¾ | Cube: | 39 |
| Seat Width (armless): | 84½ | COM: | See page 228 |
| Seat Width (one arm): | 80½ | Weight Rating: | 300 lbs. (per seat) |
| Seat Width (both arms): | 76½ | | |

FABRIC PRICE CODES

| | | | |
|-------------------------|-------------|-------------------|---------------|
| 1 | | \$4708 | |
| Add to Base Price Above | | | |
| | Seat | Back/Frame | Screen |
| | 1 | 1 | \$150 |
| | 2 | 2 | \$413 |
| | 3 | 3 | \$683 |
| | 4 | 4 | \$906 |
| | 5 | 5 | \$1206 |
| | 6 | 6 | \$1511 |
| | 7 | 7 | \$1824 |
| | 8 | 8 | \$2143 |
| | 9 | 9 | \$2193 |
| | 10 | 10 | \$2462 |
| | 11 | 11 | \$2732 |
| | 12 | 12 | \$3001 |

HON Recommendation: HASHB3.B.PURL__KMD.DW__ - List Price \$5957

HOW TO SPECIFY

| | | | | | | |
|--|---|--|--|--|---|---|
| Select Model Number HASHB3MF | Select Arm Type N Armless L Left Side (+ \$450) R Right Side (+ \$450) B Both Side Screens (+ \$900) | Select Fabric See page 228 Specify for Single Fabric model only | Select Seat Cushion Fabric See page 228 Specify for MF model only | Select Back and Frame Fabric See page 228 Specify for MF model only | Select Screen Knit or Fabric Knit Options: KLT Light KMD Medium KDK Dark See page 228 for all options | Select Leg and Color DW Dowel Wood PM Post Metal (+ \$50) SW Sled Wood (+ \$100) See page 228 for colors |
| H A S H B 3 M F . | B . | P B L E 0 7 . | P B L E 0 9 . | P B L E 0 6 . | K M D . | P M P 8 V |



HASLBTC

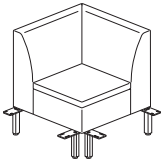

TRUE CORNER LOUNGE — LOW-BACK

DIMENSIONS

| | | | |
|-----------------------|-----|----------------|--------------|
| Depth: | 29 | Back Height: | 16 |
| Height: | 32 | Back Width: | 29 |
| Width: | 29 | Ship Weight: | 90 |
| Usable Seat Depth: | 19¾ | Cube: | 21.2 |
| Seat to Floor Height: | 18¾ | COM: | See page 228 |
| Seat Width: | 20¼ | Weight Rating: | 300 lbs. |

FABRIC PRICE CODES

| | | | |
|---|--------|----|--------|
| 1 | \$2195 | 8 | \$3101 |
| 2 | \$2315 | 9 | \$3124 |
| 3 | \$2437 | 10 | \$3246 |
| 4 | \$2539 | 11 | \$3368 |
| 5 | \$2675 | 12 | \$3491 |
| 6 | \$2814 | L | — |
| 7 | \$2956 | | |

NOTES: True Corner uses legs from adjacent units, and can work with all leg styles. For adjacent units with sled legs, pick a single leg option for the True Corner rear leg.

- ⓘ True Corner designed to act as a corner between two adjacent units, not as a stand-alone unit.
- ⓘ True Corner leg selection refers to back corner leg only, and ships with only that leg.

HASLBTCMF

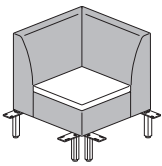

TRUE CORNER LOUNGE — LOW-BACK, MULTI-FABRIC

DIMENSIONS

| | | | |
|-----------------------|-----|----------------|--------------|
| Depth: | 29 | Back Height: | 16 |
| Height: | 32 | Back Width: | 29 |
| Width: | 29 | Ship Weight: | 90 |
| Usable Seat Depth: | 19¾ | Cube: | 21.2 |
| Seat to Floor Height: | 18¾ | COM: | See page 228 |
| Seat Width: | 20¼ | Weight Rating: | 300 lbs. |

FABRIC PRICE CODES

| | | |
|----|--------------------------------|-------------------|
| 1 | \$2354 | |
| | <i>Add to Base Price Above</i> | |
| | Seat | Frame/Back |
| 2 | \$36 | \$96 |
| 3 | \$73 | \$194 |
| 4 | \$103 | \$275 |
| 5 | \$144 | \$384 |
| 6 | \$186 | \$495 |
| 7 | \$228 | \$609 |
| 8 | \$272 | \$725 |
| 9 | \$279 | \$743 |
| 10 | \$315 | \$841 |
| 11 | \$352 | \$939 |
| 12 | \$389 | \$1037 |

NOTES: True Corner uses legs from adjacent units, and can work with all leg styles. For adjacent units with sled legs, pick a single leg option for the True Corner rear leg.

- ⓘ True Corner designed to act as a corner between two adjacent units, not as a stand-alone unit.
- ⓘ True Corner leg selection refers to back corner leg only, and ships with only that leg.

HON Recommendation: HASLBTC.PURL__DW__ - List Price \$2437

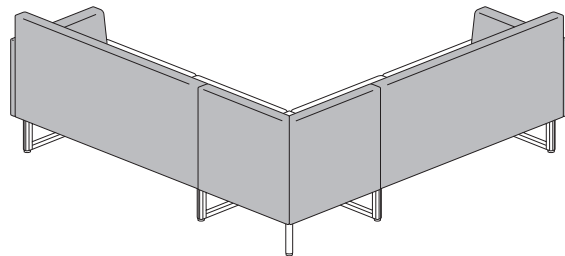
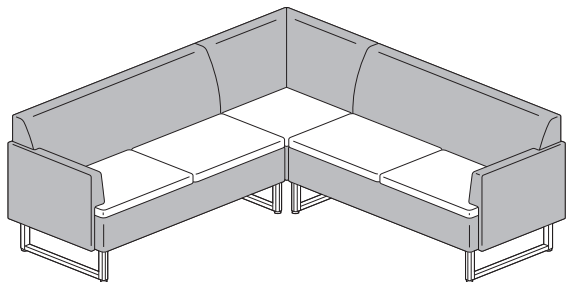

HOW TO SPECIFY

| | | | | |
|--|--|--|--|---|
| <p>Select Model Number</p> <p>See page 228</p> <p><i>Specify for Single Fabric model only</i></p> | <p>Select Fabric</p> <p>See page 228</p> <p><i>Specify for Single Fabric model only</i></p> | <p>Select Seat Cushion Fabric</p> <p>See page 228</p> <p><i>Specify for MF model only</i></p> | <p>Select Back and Frame Fabric</p> <p>See page 228</p> <p><i>Specify for MF model only</i></p> | <p>Select Leg and Color</p> <p>DW Dowel Wood PM Post Metal (+ \$50)</p> <p>See page 228 for colors</p> |
| H A S L B T C M F . | P B L E 0 7 . | P B L E 0 9 . | P B L E 0 6 . | P M P 8 V |

ASTIR™ Collaborative Work Seating

OPEN MARKET



Icon Legend on page 17

HASHBTC

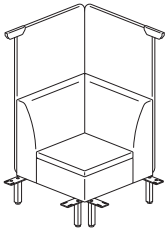

TRUE CORNER LOUNGE — HIGH-BACK SCREEN

DIMENSIONS

| | | | |
|-----------------------|-----|----------------|--------------|
| Depth: | 29¾ | Back Height: | 16 |
| Height: | 54 | Back Width: | 29 |
| Width: | 29¾ | Ship Weight: | 119 |
| Usable Seat Depth: | 19¾ | Cube: | 28.1 |
| Seat to Floor Height: | 18¾ | COM: | See page 228 |
| Seat Width: | 20¼ | Weight Rating: | 300 lbs. |

FABRIC PRICE CODES

1 \$3021

Add to Base Price Above

| | Unit | Knit | Screen |
|----|--------|------|--------|
| 1 | — | 1 | \$150 |
| 2 | \$120 | 2 | \$282 |
| 3 | \$242 | 3 | \$417 |
| 4 | \$344 | 4 | \$528 |
| 5 | \$480 | 5 | \$678 |
| 6 | \$619 | 6 | \$831 |
| 7 | \$761 | 7 | \$987 |
| 8 | \$906 | 8 | \$1147 |
| 9 | \$929 | 9 | \$1171 |
| 10 | \$1051 | 10 | \$1306 |
| 11 | \$1173 | 11 | \$1441 |
| 12 | \$1296 | 12 | \$1575 |

NOTES: True Corner uses legs from adjacent units, and can work with all leg styles. For adjacent units with sled legs, pick a single leg option for the True Corner rear leg.

- ❗ True Corner designed to act as a corner between two adjacent units, not as a stand-alone unit.
- ❗ True Corner leg selection refers to back corner leg only, and ships with only that leg.

HASHBTCMF

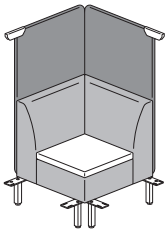

TRUE CORNER LOUNGE — HIGH-BACK SCREEN, MULTI-FABRIC

DIMENSIONS

| | | | |
|-----------------------|-----|----------------|--------------|
| Depth: | 29¾ | Back Height: | 16 |
| Height: | 54 | Back Width: | 29 |
| Width: | 29¾ | Ship Weight: | 119 |
| Usable Seat Depth: | 19¾ | Cube: | 28.1 |
| Seat to Floor Height: | 18¾ | COM: | See page 228 |
| Seat Width: | 20¼ | Weight Rating: | 300 lbs. |

FABRIC PRICE CODES

1 \$3180

Add to Base Price Above

| | Seat | Back/Frame | Knit | Screen |
|----|-------|------------|------|--------|
| 1 | — | — | 1 | \$150 |
| 2 | \$36 | \$96 | 2 | \$282 |
| 3 | \$73 | \$194 | 3 | \$417 |
| 4 | \$103 | \$275 | 4 | \$528 |
| 5 | \$144 | \$384 | 5 | \$678 |
| 6 | \$186 | \$495 | 6 | \$831 |
| 7 | \$228 | \$609 | 7 | \$987 |
| 8 | \$272 | \$725 | 8 | \$1147 |
| 9 | \$279 | \$743 | 9 | \$1171 |
| 10 | \$315 | \$841 | 10 | \$1306 |
| 11 | \$352 | \$939 | 11 | \$1441 |
| 12 | \$389 | \$1037 | 12 | \$1575 |

NOTES: True Corner uses legs from adjacent units, and can work with all leg styles. For adjacent units with sled legs, pick a single leg option for the True Corner rear leg.

- ❗ True Corner designed to act as a corner between two adjacent units, not as a stand-alone unit.
- ❗ True Corner leg selection refers to back corner leg only, and ships with only that leg.

HON Recommendation: HASHBTC.PURL__KMD.DW__ - List Price \$3263

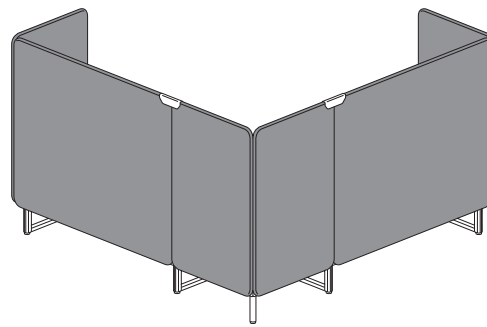
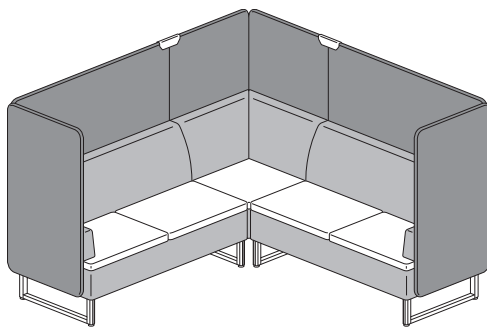

SEATING

HOW TO SPECIFY

| | | | | | |
|--|---|---|---|---|---|
| <p>Select Model Number</p> <p>H A S H B T C M F .</p> | <p>Select Fabric</p> <p>See page 228 Specify for Single Fabric model only</p> <p>P B L E 0 7 .</p> | <p>Select Seat Cushion Fabric</p> <p>See page 228 Specify for MF model only</p> <p>P B L E 0 9 .</p> | <p>Select Back and Frame Fabric</p> <p>See page 228 Specify for MF model only</p> <p>P B L E 0 6 .</p> | <p>Select Screen Knit or Fabric</p> <p>Knit Options: KLT Light KMD Medium KDK Dark See page 228 for all options</p> <p>K M D .</p> | <p>Select Leg and Color</p> <p>DW Dowel Wood PM Post Metal (+ \$50) See page 228 for colors</p> <p>P M P 8 V</p> |
|--|---|---|---|---|---|



HASB2

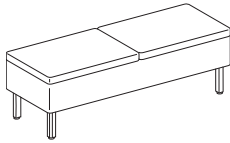

TWO-SEAT BENCH

DIMENSIONS

| | | | |
|-----------------------|-----|----------------|---------------------|
| Depth: | 20¼ | Seat Width: | 56¼ |
| Height: | 19 | Ship Weight: | 46 |
| Width: | 56½ | Cube: | 8.7 |
| Usable Seat Depth: | 20¼ | COM: | See page 228 |
| Seat to Floor Height: | 18¾ | Weight Rating: | 300 lbs. (per seat) |

FABRIC PRICE CODES

| | | | |
|---|--------|----|--------|
| 1 | \$2120 | 8 | \$2935 |
| 2 | \$2228 | 9 | \$2956 |
| 3 | \$2338 | 10 | \$3066 |
| 4 | \$2429 | 11 | \$3176 |
| 5 | \$2552 | 12 | \$3286 |
| 6 | \$2677 | L | — |
| 7 | \$2805 | | |

HASB2MF

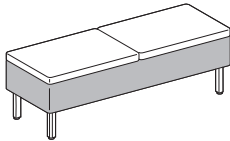

TWO-SEAT BENCH, MULTI-FABRIC

DIMENSIONS

| | | | |
|-----------------------|-----|----------------|---------------------|
| Depth: | 20¼ | Seat Width: | 56¼ |
| Height: | 19 | Ship Weight: | 46 |
| Width: | 56½ | Cube: | 8.7 |
| Usable Seat Depth: | 20¼ | COM: | See page 228 |
| Seat to Floor Height: | 18¾ | Weight Rating: | 300 lbs. (per seat) |

FABRIC PRICE CODES

| | | | |
|--------------------------------|-------------|--------------|--|
| 1 | \$2279 | | |
| <i>Add to Base Price Above</i> | | | |
| | Seat | Frame | |
| 2 | \$72 | \$48 | |
| 3 | \$145 | \$97 | |
| 4 | \$206 | \$137 | |
| 5 | \$288 | \$192 | |
| 6 | \$371 | \$248 | |
| 7 | \$457 | \$304 | |
| 8 | \$544 | \$362 | |
| 9 | \$557 | \$371 | |
| 10 | \$631 | \$420 | |
| 11 | \$704 | \$469 | |
| 12 | \$778 | \$518 | |

HON Recommendation: HASB2.PURL___.DW__ - List Price \$2338

HOW TO SPECIFY

| | | | | |
|--|---|---|--|--|
| <p>Select Model Number</p> <p>HASB2MF</p> | <p>Select Fabric</p> <p>See page 228 <i>Specify for Single Fabric model only</i></p> <p>PBLE07</p> | <p>Select Seat Cushion Fabric</p> <p>See page 228 <i>Specify for MF model only</i></p> <p>PBLE09</p> | <p>Select Frame Fabric</p> <p>See page 228 <i>Specify for MF model only</i></p> <p>PBLE06</p> | <p>Select Leg and Color</p> <p>DW Dowel Wood PM Post Metal (+ \$50) SW Sled Wood (+ \$100) See page 228 for colors</p> <p>PMP8V</p> |
|--|---|---|--|--|

ASTIR™ Collaborative Work Seating

OPEN MARKET



Icon Legend on page 17

HASB3

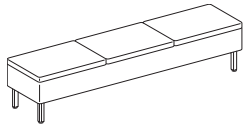

THREE-SEAT BENCH

DIMENSIONS

| | | | |
|-----------------------|-----|----------------|---------------------|
| Depth: | 20¼ | Seat Width: | 84½ |
| Height: | 19 | Ship Weight: | 61 |
| Width: | 84½ | Cube: | 12.2 |
| Usable Seat Depth: | 20¼ | COM: | See page 228 |
| Seat to Floor Height: | 18¾ | Weight Rating: | 300 lbs. (per seat) |

FABRIC PRICE CODES

| | | | |
|---|--------|----|--------|
| 1 | \$2650 | 8 | \$3828 |
| 2 | \$2806 | 9 | \$3857 |
| 3 | \$2965 | 10 | \$4016 |
| 4 | \$3097 | 11 | \$4175 |
| 5 | \$3274 | 12 | \$4335 |
| 6 | \$3454 | L | — |
| 7 | \$3639 | | |

HASB3MF

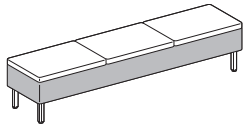

THREE-SEAT BENCH, MULTI-FABRIC

DIMENSIONS

| | | | |
|-----------------------|-----|----------------|---------------------|
| Depth: | 20¼ | Seat Width: | 84½ |
| Height: | 19 | Ship Weight: | 61 |
| Width: | 84½ | Cube: | 12.2 |
| Usable Seat Depth: | 20¼ | COM: | See page 228 |
| Seat to Floor Height: | 18¾ | Weight Rating: | 300 lbs. (per seat) |

FABRIC PRICE CODES

| | | | |
|--------------------------------|-------------|--------------|--|
| 1 | \$2809 | | |
| <i>Add to Base Price Above</i> | | | |
| | Seat | Frame | |
| 2 | \$96 | \$60 | |
| 3 | \$194 | \$121 | |
| 4 | \$275 | \$172 | |
| 5 | \$384 | \$240 | |
| 6 | \$495 | \$309 | |
| 7 | \$609 | \$380 | |
| 8 | \$725 | \$453 | |
| 9 | \$743 | \$464 | |
| 10 | \$841 | \$525 | |
| 11 | \$939 | \$587 | |
| 12 | \$1037 | \$648 | |

HON Recommendation: HASB3.PURL__DW__ - List Price \$2965

SEATING

HOW TO SPECIFY

| | | | | |
|--|---|---|--|---|
| <p>Select Model Number</p> <p>HASB3MF .</p> | <p>Select Fabric</p> <p>See page 228 <i>Specify for Single Fabric model only</i></p> <p>PBLE07 .</p> | <p>Select Seat Cushion Fabric</p> <p>See page 228 <i>Specify for MF model only</i></p> <p>PBLE09 .</p> | <p>Select Frame Fabric</p> <p>See page 228 <i>Specify for MF model only</i></p> <p>PBLE06 .</p> | <p>Select Leg and Color</p> <p>DW Dowel Wood PM Post Metal (+ \$50) SW Sled Wood (+ \$100) See page 228 for colors</p> <p>PMP8V</p> |
|--|---|---|--|---|



HASPSS

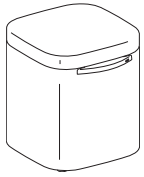

POUF

DIMENSIONS

| | | | |
|-----------------------|-----|----------------|---------------------|
| Depth: | 17¼ | Seat Width: | 16½ |
| Height: | 18¾ | Ship Weight: | 25 |
| Width: | 16½ | Cube: | 3.5 |
| Usable Seat Depth: | 16½ | COM: | See page 228 |
| Seat to Floor Height: | 17½ | Weight Rating: | 300 lbs. (per seat) |

FABRIC PRICE CODES

| | | | |
|---|-------|----|--------|
| 1 | \$631 | 8 | \$993 |
| 2 | \$679 | 9 | \$1002 |
| 3 | \$728 | 10 | \$1051 |
| 4 | \$768 | 11 | \$1100 |
| 5 | \$823 | 12 | \$1149 |
| 6 | \$879 | L | — |
| 7 | \$935 | | |

HASPSSMF

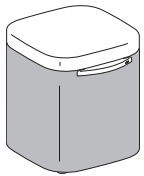

POUF, MULTI-FABRIC

DIMENSIONS

| | | | |
|-----------------------|-----|----------------|---------------------|
| Depth: | 17¼ | Seat Width: | 16½ |
| Height: | 18¾ | Ship Weight: | 25 |
| Width: | 16½ | Cube: | 3.5 |
| Usable Seat Depth: | 16½ | COM: | See page 228 |
| Seat to Floor Height: | 17½ | Weight Rating: | 300 lbs. (per seat) |

FABRIC PRICE CODES

| | | |
|--------------------------------|-------|-------|
| 1 | \$790 | |
| <i>Add to Base Price Above</i> | | |
| | Seat | Frame |
| 2 | \$24 | \$36 |
| 3 | \$48 | \$73 |
| 4 | \$69 | \$103 |
| 5 | \$96 | \$144 |
| 6 | \$124 | \$186 |
| 7 | \$152 | \$228 |
| 8 | \$181 | \$272 |
| 9 | \$186 | \$279 |
| 10 | \$210 | \$315 |
| 11 | \$235 | \$352 |
| 12 | \$259 | \$389 |

HON Recommendation: HASPSS.PURL__H.BL - List Price \$728

HOW TO SPECIFY

| | | | |
|--|--|---|---|
| <p>Select Model Number</p> <p>See page 228</p> <p>H A S P S S .</p> | <p>Select Fabric</p> <p>See page 228</p> <p>P B L E 0 7 .</p> | <p>Select Leg and Color</p> <p>HG Hidden Glide H Caster</p> <p>H G .</p> | <p>Select Handle Color</p> <p>BL Black Handle</p> <p>B L</p> |
|--|--|---|---|

HOW TO SPECIFY

| | | | | |
|--|---|--|---|---|
| <p>Select Model Number</p> <p>See page 228</p> <p>H A S P S S M F .</p> | <p>Select Seat Cushion Fabric</p> <p>See page 228</p> <p>P B L E 0 7 .</p> | <p>Select Frame Fabric</p> <p>See page 228</p> <p>P B L E 0 6 .</p> | <p>Select Leg and Color</p> <p>HG Hidden Glide H Caster</p> <p>H G .</p> | <p>Select Handle Color</p> <p>BL Black Handle</p> <p>B L</p> |
|--|---|--|---|---|

ASTIR™ Collaborative Work Seating

OPEN MARKET



Icon Legend on page 17

HASSP

HIGH-BACK SCREEN — SIDE PRIVACY

DIMENSIONS

Ship Weight: 3.2
Cube: 3.2
COM: 3.0

LIST PRICE

Knit \$1590

| | | | |
|---|--------|----|--------|
| 1 | \$1640 | 7 | \$2097 |
| 2 | \$1712 | 8 | \$2184 |
| 3 | \$1785 | 9 | \$2197 |
| 4 | \$1846 | 10 | \$2271 |
| 5 | \$1928 | 11 | \$2344 |
| 6 | \$2011 | 12 | \$2418 |

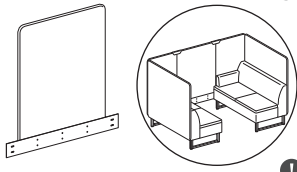

ⓘ Requires High-Back Screen units with arms on each unit.

HASGBSL

SHARED LEG GANGING BRACKET

DIMENSIONS

Ship Weight: 4
Cube: 0.1

LIST PRICE

\$212

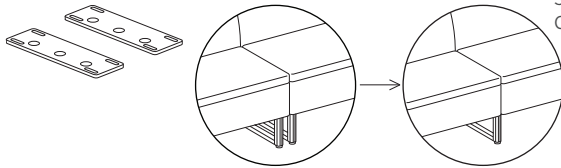

NOTES: Uses existing legs on units being ganged. No specification needed.
SPECIFYING EXAMPLE: HASGBSL

HASSGC

SCREEN GANGING CLIP

DIMENSIONS

Ship Weight: 1
Cube: 0.1

LIST PRICE

\$106

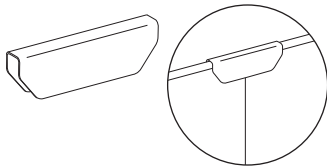

ⓘ Required when ganging multiple high-back units together.
ⓘ Already included on individual units where applicable.

HOW TO SPECIFY

Select Model Number

Select Screen Knit or Fabric

Knit Options:
KLT Light
KMD Medium
KDK Dark
See page 228 for all options

HASSP.

KMD

HOW TO SPECIFY

Select Model Number



Select Paint Color

P7A Textured Charcoal

HASSGC.

P7A

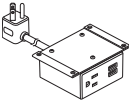

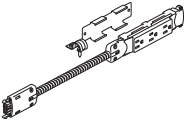
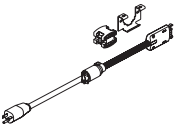
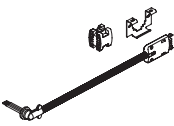
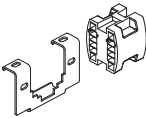
| | DESCRIPTION | MODEL | SHIP WEIGHT | CUBE | LIST PRICE |
|---|--|---|--------------------------------|--|--|
|  | Miki Under-Mount Power Module <ul style="list-style-type: none"> Includes 6' cord with three-prong plug. 1 Receptacle, 2 USB Available in STRM Storm and SNW Snow. SPECIFYING EXAMPLE: HUMPWR-1P-2U.STRM | HUMPWR-1P-2U | 2 | 0.6 | \$191 |
|  | Vesta Mobile Power Station <ul style="list-style-type: none"> Includes 10' retractable cord with three-prong plug. 3 AC, 1 Dual USB-A, 1 USB-C at top Specify Paint and Plastic. SPECIFYING EXAMPLE: HPWRMOB1.BLK.STRM | HPWRMOB1 | 14 | 3.3 | \$1100 |
|  | Triplex Electrical Harness 48"W, Circuit 1 60"W, Circuit 1 72"W, Circuit 1 48"W, Circuit 2 60"W, Circuit 2 72"W, Circuit 2 | HTPKIT48 HTPKIT60 HTPKIT72 HTPKIT482 HTPKIT602 HTPKIT722 | 5 5 5 5 5 5 | 0.3 0.3 0.3 0.3 0.3 0.3 | \$215 \$220 \$225 \$215 \$220 \$225 |
|  | Triplex Corded In-Feed 48"W Corded In-feed 72"W Corded In-feed NOTES: Corded in-feed ships with (1) 4-way splitter, (1) 4-way splitter mounting bracket, (1) conduit clip, and (1) in-feed. Utilizes standard 3-prong plug for easy setup and installation. Use with circuit 1 harnesses only. Corded in-feed not UL listed. | HTPCIF48 HTPCIF72 | 5 5 | 0.3 0.3 | \$279 \$295 |
|  | Triplex Hardwire In-Feed 48"W Hardwire In-feed NOTES: Hardwire in-feed ships with (1) 4-way splitter, (1) 4-way splitter mounting bracket, (1) conduit clip, and (1) in-feed. Hardwire in-feed must be installed by a licensed electrician. | HTPHWIF72 | 5 | 0.3 | \$241 |
|  | Triplex 4-Way Splitter 4-Way Splitter NOTES: 4-way splitter utilized in instances where one power harness feeds into 2-3 power harnesses. | HTPSPLIT | 5 | 0.3 | \$73 |

NOTES:

- Triplex is a 4-trac system with 3 connected simplexes per harness.
- Choose either a corded or hardwire in-feed.
- UL listed as a manufactured wiring system (UL 183) when hardwire in-feed is used.
- cUL Certified for Canada with hardwire in-feed.
- Hardwire in-feed complies with municipal standards such as in New York, Los Angeles, and San Francisco. However, it is customer's responsibility to verify local code compliance.
- Plug in any standard 2- or 3-prong plug accessory to triplex simplexes to get power to where you need it most.

HOW TO SPECIFY

| | | |
|---|--|--|
| <p>Select Model Number</p> <p>HPWRMOB1</p> | <p>Select Exterior Paint Color</p> <p><i>Specify for model HPWRMOB1 only</i></p> <p>FOG Fog STRM Storm BLK Black SNW Snow</p> <p>BLK</p> | <p>Select Paint Color</p> <p><i>Specify for model HPWRMOB1 only</i></p> <p>FOG Fog STRM Storm BLK Black SNW Snow</p> <p>STRM</p> |
|---|--|--|

CAMBIA™ 2160 SERIES

Want to see more? Scan here
to check out [hon.com](https://www.hon.com).



**Cambia Upholstered Back Guest
Chairs shown with Preside® table.**

CAMBIA™ 2160 SERIES

Cambia's comfort and style is a warm invitation for any guest or coworker. With two back variations and arm options, this is a guest chair collection designed to adapt. Each back option offers a choice of a wood slat design or upholstered panel to suit any space or personal taste. Choose from eight rich hardwood finishes and hundreds of quality HON fabrics to express your style and reflect your brand.



FEATURES

- Wood slat back panel complements a variety of surroundings.
- Upholstered seat and back features cushioning for additional comfort and support.
- Personalize your space with a choice of back styles.
- Fixed arms provide support and take pressure off the upper body and shoulders.
- Solid hardwood in one of eight attractive finishes.
- Available in hundreds of quality HON fabrics.
- Warranted for users up to 250 lbs.

CAMBIA™

2160 Series Options

MODEL OPTIONS

H2164



Guest Chair

Upholstered Back, Leg Base, Arch Arms

H2165



Guest Chair

Wood Slat Back, Leg Base, Arch Arms

AVAILABLE FINISHES

Cambia™ 2160 Series Seating is available in 8 wood finishes.

WOOD FINISHES

Bourbon Cherry (H)

Cognac (COGN)

Harvest (C)

Mahogany (N)

Mocha (MOCH)

Natural Maple (D)

Pinnacle (PINC)

Shaker Cherry (F)

HON BRANDED FABRICS

GRADE 1

Apex
Attire
Centurion
Compass
Contourett
Dapper
Ensemble
Hamilton
Inertia
Optic
Pebble

GRADE 2

Appoint Seating
Blume
Clyde
Dotty
Rush
Seed
Spin
Whisper Vinyl

GRADE 3

In Season
Moxie
Parker
Purl
Quill

GRADE L

Denver Leather

For a complete list of fabrics, including partnership fabrics, go to hon.com/fabricsandfinishes.

Reference Fabric Color Combinations on pages 18-22 for color codes and legend on page 19 for lead times. For additional HON to Supply COM fabric grade pricing, go to honready.hon.com and click on the HON to Supply COM link.

CAMBIA™ 2160 Series

GSA SIN 33721



Icon Legend on page 17

H2164



GUEST CHAIR

Upholstered Back
Leg Base
Arch Arms

DIMENSIONS

| | | | |
|--------------|-----|-----------------------|----------|
| Depth: | 24¼ | Arm Width: | 19 |
| Width: | 21¾ | Seat to Floor Height: | 19 |
| Height: | 31¾ | Usable Seat Depth: | 21 |
| Seat Depth: | 21 | Ship Weight: | 30 |
| Seat Width: | 21¾ | Cube: | 22.6 |
| Back Width: | 21¾ | COM: | 1.5 |
| Back Height: | 13¾ | Weight Rating: | 250 lbs. |

FABRIC PRICE CODES

| | | | |
|----------|---------------|-----------|---------------|
| 1 | \$788 | 8 | \$1133 |
| 2 | \$848 | 9 | \$1178 |
| 3 | \$908 | 10 | \$1223 |
| 4 | \$953 | 11 | \$1268 |
| 5 | \$998 | 12 | \$1313 |
| 6 | \$1043 | L | \$1288 |
| 7 | \$1088 | | |

H2165



GUEST CHAIR

Wood Slat Back
Leg Base
Arch Arms

DIMENSIONS

| | | | |
|--------------|-----|-----------------------|----------|
| Depth: | 24¼ | Arm Width: | 19 |
| Width: | 21¾ | Seat to Floor Height: | 19 |
| Height: | 31¾ | Usable Seat Depth: | 21 |
| Seat Depth: | 21 | Ship Weight: | 30 |
| Seat Width: | 21¾ | Cube: | 22.6 |
| Back Width: | 21¾ | COM: | 1.3 |
| Back Height: | 13¾ | Weight Rating: | 250 lbs. |

FABRIC PRICE CODES

| | | | |
|----------|---------------|-----------|---------------|
| 1 | \$830 | 8 | \$1037 |
| 2 | \$866 | 9 | \$1064 |
| 3 | \$902 | 10 | \$1091 |
| 4 | \$929 | 11 | \$1118 |
| 5 | \$956 | 12 | \$1145 |
| 6 | \$983 | L | \$1130 |
| 7 | \$1010 | | |

HON Recommendation: H2164.MOCH.CU__ - List Price \$788

HOW TO SPECIFY

Select
Model Number

H 2 1 6 4 .

Select
Finish

See page 243

M O C H .

Select
Fabric

See page 243

C U 1 0 .

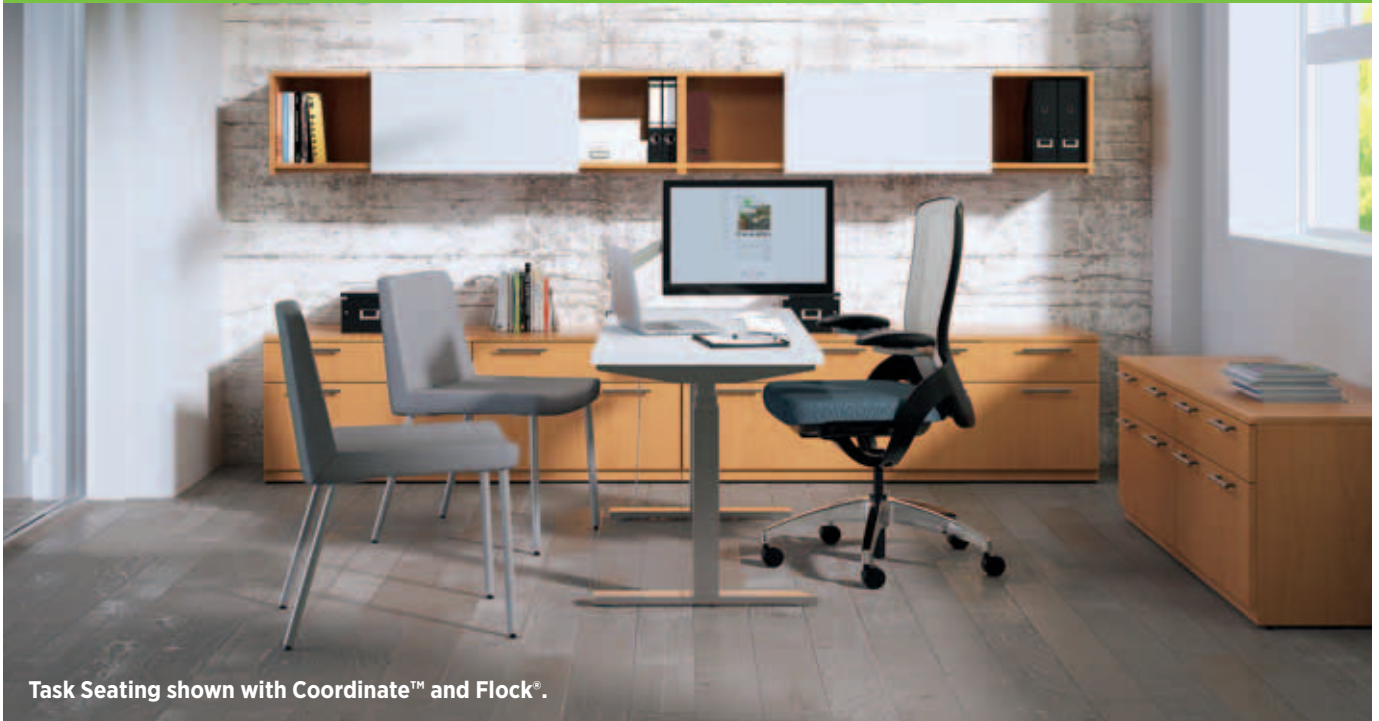

Task Seating shown with Coordinate™ and Flock®.

CERES®

Seating is personal. At the same time, it's also universal. Ceres is designed to bridge that gap by creating a holistic seating family that allows everyone to stay in control of their own comfort. As the result of exhaustive ergonomic research, the stunning Ceres collection of task and guest chairs feature total support for anyone and any space. The comfort contours cradle you throughout the workday, while projecting the right personality for your brand.



GUEST/MULTI-PURPOSE FEATURES

- 4-Way Stretch mesh back is available in seven colors.
- Model HCG6 is a four-leg multi-purpose chair with a pivoting back for added comfort.
- Model HCG6 stacks up to four high on the floor.
- Guest chairs are available with or without arms.
- Available in a multi-fabric option.
- Warranted for users up to 300 lbs.

TASK CHAIR FEATURES

- Height- and width-adjustable arms provide a custom fit.
- Seat depth adjustment adapts to users of various heights.
- One-touch seat height adjustment easily moves the seat up and down.
- Tilt tension controls the rate and ease of recline.
- Tilt lock allows the user to lock the back in multiple recline positions.
- Warranted for users up to 300 lbs.

CERES® Task Chair Options



MODEL OPTION



HCW1 *



Task Chair

Pneumatic, Swivel, Synchro-tilt,
Seat Glide Tilt Tension, Height,
Width and Depth Adjustable Arms

| ARM STYLE | CODE | DESCRIPTION | PRICE |
|---|--------------|----------------------------|--------------|
|  | ABLCK | Textured Black | +\$0 |
|  | APLAT | Textured Platinum Metallic | +\$0 |
|  | APA | Polished Aluminum | +\$75 |

| CASTERS | CODE | DESCRIPTION | PRICE |
|--|----------|--------------------------|--------------|
|  | H | Black Hard Caster | +\$0 |
|  | S | Black All-Surface Caster | +\$40 |

| BACK STYLE | CODE | DESCRIPTION | PRICE |
|---|-------------------------------|-------------|-------|
|  | <i>4-Way Stretch options:</i> | | |
| IM | Black | +\$0 | |
| IB | Breeze | +\$0 | |
| IK | Brownstone | +\$0 | |
| IC | Charcoal | +\$0 | |
| IF | Fog | +\$0 | |
| IR | Regatta | +\$0 | |
| IT | Titanium | +\$0 | |

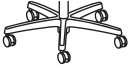
| BASE | CODE | DESCRIPTION | PRICE |
|---|-----------|-------------------|---------------|
|  | SB | Standard Base | +\$0 |
|  | PA | Polished Aluminum | +\$110 |

| FRAME | CODE | DESCRIPTION | PRICE |
|-------|----------|-------------|-------------|
| | T | Black | +\$0 |

* De-emphasized

CERES® Multi-Purpose Chair Options

MODEL OPTION

HCG6



Multi-Purpose

Four-leg stacking frame with pivoting back

HCG6DF - Multi-Fabric



Multi-Purpose

Four-leg stacking frame with pivoting back

ARM STYLE



| CODE | DESCRIPTION | PRICE |
|----------|-------------|-------------|
| N | Armless | +\$0 |



| | | |
|----------|------------|--------------|
| F | Fixed Arms | +\$55 |
|----------|------------|--------------|

CASTERS/ GLIDE



| CODE | DESCRIPTION | PRICE |
|----------|-------------------|-------------|
| H | Black Hard Caster | +\$0 |



| | | |
|----------|--------------------------|--------------|
| S | Black All-Surface Caster | +\$30 |
|----------|--------------------------|--------------|



| | | |
|----------|-------|-------------|
| E | Glide | +\$0 |
|----------|-------|-------------|

BACK STYLE



| CODE | DESCRIPTION | PRICE |
|-----------|---------------------|-------------|
| PB | Upholstered in-back | +\$0 |



4-Way Stretch options:

| | | |
|-----------|------------|-------------|
| IM | Black | +\$0 |
| IB | Breeze | +\$0 |
| IK | Brownstone | +\$0 |
| IC | Charcoal | +\$0 |
| IF | Fog | +\$0 |
| IR | Regatta | +\$0 |
| IT | Titanium | +\$0 |

FRAME

| CODE | DESCRIPTION | PRICE |
|-------------|----------------------------|-------------|
| BLCK | Textured Black Mica | +\$0 |
| PLAT | Textured Platinum Metallic | +\$0 |

CERES® Fabric Options

HON BRANDED FABRICS

| GRADE 1 | GRADE 2 | GRADE 3 | GRADE L |
|------------|-----------------|-----------|-----------------|
| Apex | Appoint Seating | In Season | Denver Leather* |
| Attire | Blume | Moxie | |
| Centurion | Clyde | Parker | |
| Compass | Dotty | Purl | |
| Contourett | Rush | Quill | |
| Dapper | Seed | | |
| Ensemble | Spin | | |
| Hamilton | Whisper Vinyl | | |
| Inertia | | | |
| Optic | | | |
| Pebble | | | |

For a complete list of fabrics, including partnership fabrics, go to hon.com/fabricsandfinishes.

Reference Fabric Color Combinations on pages 18-22 for color codes and legend on page 19 for lead times. For additional HON to Supply COM fabric grade pricing, go to honready.hon.com and click on the HON to Supply COM link.

*Denver Leather (SS) may not be available on every model within a specific series, please refer to the model's page for details.



HCW1



TASK CHAIR

Pneumatic
Swivel
Synchro-tilt
Seat Glide Tilt Tension
Height, Width and Depth
Adjustable Arms
Functions:
A, D, E, A-C, A-D, B-A
(Function Key on pages 212-213)

DIMENSIONS

Depth: 27¾
Width: 27½
Height: 43⅜
Seat Depth: 19
Seat Width: 20
Back Width: 16½
Back Height: 22½
Arm Width: 17½-21
Seat to Floor Height: 17-21½
Usable Seat Depth: 17-19½
Ship Weight (upholstered back): 39
Ship Weight (mesh back): 39
Cube (upholstered back): 11.3
Cube (mesh back): 11.3
COM (upholstered back): 1.0
COM (mesh back): 1.0
Weight Rating: 300 lbs.

FABRIC PRICE CODES

| | | | |
|---|--------|----|--------|
| 1 | \$1542 | 8 | \$1680 |
| 2 | \$1566 | 9 | \$1698 |
| 3 | \$1590 | 10 | \$1716 |
| 4 | \$1608 | 11 | \$1734 |
| 5 | \$1626 | 12 | \$1752 |
| 6 | \$1644 | L | \$1742 |
| 7 | \$1662 | | |

HON Recommendation: HCW1.ABLCK.H.IM.CU__SB.T - List Price \$1542

* De-emphasized

HOW TO SPECIFY

| Select Model Number | Select Arm Option | Select Caster/Glide | Select Back Option | Select Fabric | Select Base | Select Frame |
|---|--|--|--------------------|--|----------------|--------------|
| Adjustable Arms Finishes ABLCK Textured Black APLAT Textured Platinum Metallic APA Polished Aluminum (+ \$75) | H Black Hard Caster S Black All-Surface Caster (+ \$40) | PB Upholstered in-back Mesh Back Options IM Black IB Breeze IK Brownstone IC Charcoal IF Fog IR Regatta IT Titanium | See page 248 | SB Standard Base PA Polished Aluminum (+ \$110) | T Black | |
| HCW1 | ABLCK | H | IM | CU10 | SB | T |

HCG6

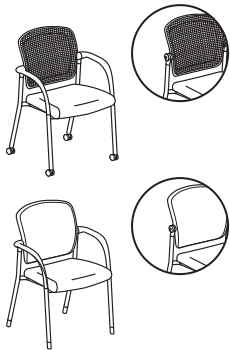

MULTI-PURPOSE

Four-leg stacking frame with pivoting back

DIMENSIONS

| | | | |
|--------------|-----|---------------------------------|----------|
| Depth: | 25 | Seat to Floor Height: | 18¾ |
| Width: | 24½ | Usable Seat Depth: | 17¼ |
| Height: | 35 | Ship Weight (upholstered back): | 22 |
| Seat Depth: | 19½ | Ship Weight (mesh back): | 22 |
| Seat Width: | 20 | Cube (upholstered back): | 15.2 |
| Back Width: | 17½ | Cube (mesh back): | 15.2 |
| Back Height: | 17 | COM (upholstered back): | 1.0 |
| Arm Width: | 20¼ | COM (mesh back): | 1.0 |
| | | Weight Rating: | 300 lbs. |

FABRIC PRICE CODES

| | | | |
|----------|--------------|-----------|--------------|
| 1 | \$605 | 8 | \$743 |
| 2 | \$629 | 9 | \$761 |
| 3 | \$653 | 10 | \$779 |
| 4 | \$671 | 11 | \$797 |
| 5 | \$689 | 12 | \$815 |
| 6 | \$707 | L | \$805 |
| 7 | \$725 | | |

NOTES: Multi-purpose model HCG6, with or without arms, stacks up to 4-high.

HON Recommendation: HCG6.F.H.IM.CU__BLCK - List Price \$660

HOW TO SPECIFY

| | | | | | |
|---|---|---|--|---|--|
| <p>Select Model Number</p> <p>HCG6</p> | <p>Select Arm Option</p> <p>F Fixed Arms (+ \$55) N Armless</p> <p>F</p> | <p>Select Caster/Glide</p> <p>E Glide H Black Hard Caster S Black All-Surface Caster (+ \$30)</p> <p>H</p> | <p>Select Back Option</p> <p>PB Upholstered in-back Mesh Back Options</p> <p>IM Black IB Breeze IK Brownstone IC Charcoal IF Fog IR Regatta IT Titanium</p> <p>IM</p> | <p>Select Fabric</p> <p>See page 248</p> <p>CU10</p> | <p>Select Frame</p> <p>BLCK Textured Black Mica PLAT Textured Platinum Metallic</p> <p>BLCK</p> |
|---|---|---|--|---|--|

HCG6DF

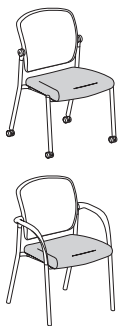

MULTI-PURPOSE

Multi-Fabric
Four-leg stacking frame with pivoting back

DIMENSIONS

| | | | |
|--------------|-----|---------------------------------|----------|
| Depth: | 25 | Arm Width: | 20¼ |
| Width: | 24½ | Seat to Floor Height: | 18¾ |
| Height: | 35 | Usable Seat Depth: | 17¼ |
| Seat Depth: | 19½ | Ship Weight (upholstered back): | 22 |
| Seat Width: | 20 | Cube (upholstered back): | 15.2 |
| Back Width: | 17½ | COM (back): | 0.8 |
| Back Height: | 17 | COM (seat): | 1.0 |
| | | Weight Rating: | 300 lbs. |

FABRIC PRICE CODES

| | | | |
|--------------------------------|--------------|--------------|-------------|
| 1 | \$680 | | |
| <i>Add to Base Price Above</i> | | | |
| | | Back | Seat |
| 2 | \$18 | \$24 | |
| 3 | \$36 | \$48 | |
| 4 | \$50 | \$66 | |
| 5 | \$63 | \$84 | |
| 6 | \$77 | \$102 | |
| 7 | \$90 | \$120 | |
| 8 | \$104 | \$138 | |
| 9 | \$117 | \$156 | |
| 10 | \$131 | \$174 | |
| 11 | \$144 | \$192 | |
| 12 | \$158 | \$210 | |
| L | \$150 | \$200 | |

NOTES: Multi-purpose model HCG6DF, with or without arms, stacks up to 4-high.

HON Recommendation: HCG6DF.F.H.PB.CU__CU__BLCK - List Price \$777

HOW TO SPECIFY

| | | | | | | |
|---|---|---|--|--|--|--|
| <p>Select Model Number</p> <p>HCG6DF</p> | <p>Select Arm Option</p> <p>F Fixed Arms (+ \$55) N Armless</p> <p>F</p> | <p>Select Caster/Glide</p> <p>E Glide H Black Hard Caster S Black All-Surface Caster (+ \$30)</p> <p>H</p> | <p>Select Back Option</p> <p>PB Upholstered in-back</p> <p>PB</p> | <p>Select Back Fabric</p> <p>See page 248</p> <p>CU22</p> | <p>Select Seat Fabric</p> <p>See page 248</p> <p>CU10</p> | <p>Select Frame</p> <p>BLCK Textured Black Mica PLAT Textured Platinum Metallic</p> <p>BLCK</p> |
|---|---|---|--|--|--|--|



HVL643



GUEST CHAIR

4-Leg Base
Padded Arms

DIMENSIONS

| | | | |
|--------------|-----|-----------------------|----------|
| Depth: | 28½ | Arm Width: | 18½ |
| Width: | 24½ | Seat to Floor Height: | 19½ |
| Height: | 34½ | Usable Seat Depth: | 19½ |
| Seat Depth: | 19½ | Ship Weight: | 36 |
| Seat Width: | 19 | Cube: | 4.5 |
| Back Width: | 21¼ | Weight Rating: | 250 lbs. |
| Back Height: | 18 | | |

PRICE CODE

Leather \$400

NOTES: Black Bonded Leather with pleated stitching detail. Black frame. **HON 5-Year Limited Warranty.**

HON Recommendation: HVL643.SB11 - List Price \$400

HOW TO SPECIFY

| | |
|----------------------------|----------------------------------|
| Select Model Number | Select Fabric |
| | SB11 Black Bonded Leather |
| H V L 6 4 3 . | S B 1 1 |



HVL871

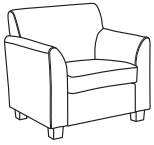

CLUB CHAIR

DIMENSIONS

| | | | |
|--------------|-----|-----------------------|----------|
| Depth: | 28¾ | Arm Width: | 21½ |
| Width: | 33 | Seat to Floor Height: | 18½ |
| Height: | 32 | Usable Seat Depth: | 21 |
| Seat Depth: | 21 | Ship Weight: | 51 |
| Seat Width: | 21½ | Cube: | 20.7 |
| Back Width: | 30 | Weight Rating: | 250 lbs. |
| Back Height: | 18½ | | |

PRICE CODE

Leather **\$1413**

NOTES: Legs available in Black. Legs ship unattached. Available in SB11 Black Bonded Leather only. **HON 5-Year Limited Warranty.**

HON Recommendation: HVL871.SB11 - List Price \$1413

HVL872

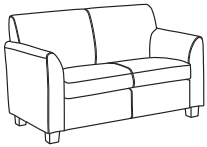

LOVE SEAT

DIMENSIONS

| | | | |
|--------------|-----|-----------------------|----------|
| Depth: | 28¾ | Arm Width: | 42 |
| Width: | 53½ | Seat to Floor Height: | 18½ |
| Height: | 32 | Usable Seat Depth: | 21 |
| Seat Depth: | 21 | Ship Weight: | 76 |
| Seat Width: | 42 | Cube: | 33.1 |
| Back Width: | 50 | Weight Rating: | 250 lbs. |
| Back Height: | 18½ | | |

PRICE CODE

Leather **\$1792**

NOTES: Legs available in Black. Legs ship unattached. Available in SB11 Black Bonded Leather only. **HON 5-Year Limited Warranty.**

HON Recommendation: HVL872.SB11 - List Price \$1792

HVL873

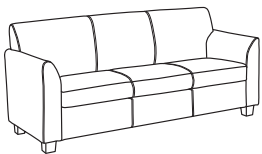

SOFA

DIMENSIONS

| | | | |
|--------------|-----|-----------------------|----------|
| Depth: | 28¾ | Arm Width: | 61½ |
| Width: | 73 | Seat to Floor Height: | 18½ |
| Height: | 32 | Usable Seat Depth: | 21 |
| Seat Depth: | 21 | Ship Weight: | 122 |
| Seat Width: | 61½ | Cube: | 45.0 |
| Back Width: | 70 | Weight Rating: | 250 lbs. |
| Back Height: | 18½ | | |

PRICE CODE

Leather **\$2239**

NOTES: Legs available in Black. Legs ship unattached. Available in SB11 Black Bonded Leather only. **HON 5-Year Limited Warranty.**

HON Recommendation: HVL873.SB11 - List Price \$2239

HOW TO SPECIFY

| | |
|--|---|
| <p>Select Model Number</p> <p>H V L 8 7 1 .</p> | <p>Select Fabric</p> <p>SB11 Black Bonded Leather</p> <p>S B 1 1</p> |
|--|---|



HVL691



HIGH-BACK

Pneumatic
Swivel
Tilt
Tilt Tension
Tilt Lock
Fixed Padded Arms

Functions: **A, E, F, K, L**
(Function Key on pages 212-213)

DIMENSIONS

| | | | |
|--------------|-----|-----------------------|----------|
| Depth: | 28¾ | Arm Width: | 21 |
| Width: | 27 | Seat to Floor Height: | 18¾-21¾ |
| Height: | 47¼ | Usable Seat Depth: | 17¾ |
| Seat Depth: | 20¼ | Ship Weight: | 50 |
| Seat Width: | 21½ | Cube: | 7.2 |
| Back Width: | 21½ | Weight Rating: | 250 lbs. |
| Back Height: | 27 | | |

PRICE CODE

Leather \$644

NOTES: Black Bonded Leather. Sturdy textured black frame. Fixed padded loop arms. Built-in lumbar support. Use with coordinating Guest Chair model HVL693 shown below. **HON 5-Year Limited Warranty.**

HON Recommendation: HVL691.SB11 - List Price \$644

HVL693



GUEST CHAIR

Sled Base
Padded Arms

DIMENSIONS

| | | | |
|--------------|-----|-----------------------|----------|
| Depth: | 26 | Arm Width: | 18½ |
| Width: | 24¾ | Seat to Floor Height: | 18¼ |
| Height: | 33½ | Usable Seat Depth: | 18¼ |
| Seat Depth: | 18¼ | Ship Weight: | 38 |
| Seat Width: | 20¾ | Cube: | 5.2 |
| Back Width: | 21 | Weight Rating: | 250 lbs. |
| Back Height: | 16¼ | | |

PRICE CODE

Leather \$417

NOTES: Black Bonded Leather with tailored stitching detail. Sturdy textured black frame. Built-in lumbar support. Use with coordinating Executive Chair model HVL691 shown above. **HON 5-Year Limited Warranty.**

HON Recommendation: HVL693.SB11 - List Price \$417

HOW TO SPECIFY

| | |
|----------------------------|----------------------------------|
| Select Model Number | Select Fabric |
| | SB11 Black Bonded Leather |
| H V L 6 9 1 . | S B 1 1 |



Cliq™ Seating shown with
Preside® Table and Credenza.

CLIQ™

Some of the best work results from a collaborative effort. That's why Cliq brings people together. Designed with a weight-activated control that responds to your body and its movements, Cliq just gets you — providing instant comfort without a lot of adjustments. It's light-scaled for a modern look that's also easy to maneuver around wherever the group discussion takes you. Available as a task chair or stool, Cliq features a wide selection of fabric choices and frame and mesh colors. Intuitive, stylish, and supportive — it just clicks with any collaborative environment.



FEATURES

- Intuitive functionality and design provides comfort and support without the need for multiple adjustments.
- Weight-activated control automatically adjusts to you as you sit.
- Thin profile offers a modern aesthetic, while a wide range of fabric choices ensures the perfect look within any space.
- 4-Way Stretch Mesh flexes in every direction to dynamically move with you — available in 7 colors.
- Choose between fixed arms or armless to get exactly the look you want.
- Task Chairs are available with a conference cylinder or task cylinder so you can choose the chair that best fits your space.
- Task Stools feature an adjustable footring for additional lower body support.
- One-touch seat height adjustment easily moves the seat up and down.
- Choose from 3 frame options: Black, Titanium, and Designer White.

HON BRANDED FABRICS

GRADE 1

Apex
Attire
Centurion
Compass
Contourett
Dapper
Ensemble
Hamilton
Inertia
Optic
Pebble

GRADE 2

Appoint Seating
Blume
Clyde
Dotty
Rush
Seed
Spin Seating
Whisper Vinyl

GRADE 3

In Season
Moxie
Parker
Purl
Quill

For a complete list of fabrics, including partnership fabrics, go to hon.com/fabricsandfinishes.

Reference Fabric Color Combinations on pages 18-22 for color codes and legend on page 19 for lead times.



HCLQT



LIGHT TASK CHAIR

Mesh Back
 Pneumatic
 Swivel
 Weight-activated
 Synchro-tilt
 Tilt Lock
 Functions: **A, E, J, L, P**
 (Function Key on pages 212-213)

DIMENSIONS

| | | | |
|--------------|--------------------------------|------------------------|--|
| Depth: | 27 | Seat to Floor Height | |
| Width: | 27 | (Task Cylinder): | 17-22 |
| Height: | 41 | Seat to Floor Height | |
| Seat Depth: | 17 | (Conference Cylinder): | 15 ⁵ / ₈ -19 ³ / ₈ |
| Seat Width: | 19 ¹ / ₄ | Usable Seat Depth: | 17 |
| Back Width: | 19 ¹ / ₄ | Ship Weight: | 45 |
| Back Height: | 21 | Cube: | 10.7 |
| | | COM: | 1.0 |
| | | Weight Rating: | 300 lbs. |

FABRIC PRICE CODES

| | | | |
|----------|--------------|-----------|--------------|
| 1 | \$628 | 8 | \$766 |
| 2 | \$652 | 9 | \$784 |
| 3 | \$676 | 10 | \$802 |
| 4 | \$694 | 11 | \$820 |
| 5 | \$712 | 12 | \$838 |
| 6 | \$730 | L | — |
| 7 | \$748 | | |

NOTES: When selecting the Conference Cylinder, the maximum arm height from floor is 28¹/₂".

HON Recommendation: HCLQT.W0.TC2.F.S.IT.CU__NL.SB.TI - List Price \$693

HOW TO SPECIFY

| Select Model Number | Select Control Type | Select Cylinder | Select Arm Type | Select Caster | Select Back Option | Select Fabric | Select Lumbar | Select Base | Select Frame |
|----------------------------|--|--|-----------------------------------|---|--------------------|---------------------|---|--|--------------|
| W0 Weight-Activated | TC2 Task Cylinder CC1 Conference Cylinder | N Armless F Fixed (+\$30) | S Black All-Surface Caster | IM Black IB Breeze IK Brownstone IC Charcoal IF Fog IR Regatta IT Titanium | See page 255 | NL No Lumbar | SB Standard Base PA Polished Aluminum (+\$110) | T Black TI Titanium (+\$35) DW Designer White (+\$35) | |
| HCLQT | W0 | TC2 | F | S | IT | CU19 | NL | SB | TI |



HCLQS*



TASK STOOL

Mesh Back

- Pneumatic
- Swivel
- Weight-activated
- Synchro-tilt
- Tilt Lock

Functions: **A, E, J, L, P**
 (Function Key on pages 212-213)

DIMENSIONS

| | | | |
|--------------|-----|-----------------------|----------|
| Depth: | 28¾ | Seat to Floor Height: | 23-33 |
| Width: | 28¾ | Usable Seat Depth: | 17 |
| Height: | 52 | Ship Weight: | 50 |
| Seat Depth: | 17 | Cube: | 10.7 |
| Seat Width: | 19¼ | Weight Rating: | 300 lbs. |
| Back Width: | 19¼ | | |
| Back Height: | 21 | | |

FABRIC PRICE CODES

| | | | |
|----------|--------------|-----------|--------------|
| 1 | \$697 | 8 | \$835 |
| 2 | \$721 | 9 | \$853 |
| 3 | \$745 | 10 | \$871 |
| 4 | \$763 | 11 | \$889 |
| 5 | \$781 | 12 | \$907 |
| 6 | \$799 | L | — |
| 7 | \$817 | | |

HON Recommendation: HCLQS.W0.SC2.F.S.IT.CU__NL.SB.TI - List Price \$782

*Coming Soon

HOW TO SPECIFY

| Select Model Number | Select Control Type | Select Cylinder | Select Arm Type | Select Caster | Select Back Option | Select Fabric | Select Lumbar | Select Base | Select Frame |
|----------------------------|---------------------------|---|-----------------------------------|---|--------------------|---------------------|--|--|--------------|
| W0 Weight-Activated | SC2 Stool Cylinder | N Armless F Fixed (+ \$30) | S Black All-Surface Caster | IM Black IB Breeze IK Brownstone IC Charcoal IF Fog IR Regatta IT Titanium | See page 255 | NL No Lumbar | SB Standard Base PA Polished Aluminum (+ \$110) | T Black TI Titanium (+ \$55) DW Designer White (+ \$55) | |
| HCLQS | W0 | SC2 | F | S | IT | CU19 | NL | SB | TI |

COMFORTASK® 5900 SERIES

Want to see more? Scan here
to check out hon.com.



ComforTask Chair shown
with Metro Classic desks.

COMFORTASK® 5900 SERIES

What's in a name? If it's ComforTask, it's the support you need to get the job done. ComforTask seating is a proven office performer, with cushioning in all the right places, a waterfall seat edge and the customizable comfort that allows everyone to create a personal fit. Advanced controls such as back height and seat depth adjustments take the personalization to an even higher level, earning fans throughout the office.



FEATURES

- Back height adjustment moves the back up or down to provide a custom fit.
- Seat depth adjustment on model H5901 adapts to users of various heights.
- Contoured seat and back provide targeted support.
- Waterfall seat edge encourages leg circulation.
- One-touch seat height adjustment easily moves the seat up and down.
- 360-degree swivel provides freedom of movement in any direction.
- Molded polymer outer back for added durability.
- Available in hundreds of quality HON fabrics.
- Warranted for users up to 300 lbs.

COMFORTASK® 5900 Series Options

MODEL OPTIONS

H5901



Task Chair

Pneumatic, Back Height, Seat Depth, Swivel

H5902



Task Chair

Pneumatic, Back Height, Swivel, Tilt, Tilt Tension, Tilt Lock

H5903



Task Chair

Pneumatic, Back Height, Swivel, Multi-task

H5905



Task Stool

Pneumatic, Back Height, Swivel, Adjustable Height Footring

CASTERS/ GLIDE



| CODE | DESCRIPTION | PRICE |
|----------|-------------------|-------------|
| H | Black Hard Caster | +\$0 |



| | | |
|----------|--------------------------|--------------|
| S | Black All-Surface Caster | +\$40 |
|----------|--------------------------|--------------|



| | | |
|----------|------------|--------------|
| G | Bell Glide | +\$25 |
|----------|------------|--------------|

*G only available on model H5905

FRAME

| CODE | DESCRIPTION | PRICE |
|----------|-------------|-------------|
| T | Black | +\$0 |

COMFORTASK®

5900 Series Fabric Options

HON BRANDED FABRICS

GRADE 1

Apex
Attire
Centurion
Compass
Contourett
Dapper
Ensemble
Hamilton
Inertia
Optic
Pebble

GRADE 2

Appoint Seating
Blume
Clyde
Dotty
Rush
Seed
Spin
Whisper Vinyl

GRADE 3

In Season
Moxie
Parker
Purl
Quill

For a complete list of fabrics, including partnership fabrics, go to hon.com/fabricsandfinishes.

Reference Fabric Color Combinations on pages 18-22 for color codes and legend on page 19 for lead times. COM yardage shown is for Pattern Cut only. Contact Customer Service for Railroaded yardage requirements. For additional HON to Supply COM fabric grade pricing, go to honready.hon.com and click on the HON to Supply COM link.



Icon Legend on page 17

COMFORTASK® 5900 Series

H5901



TASK

Pneumatic
Back Height
Seat Depth
Swivel
Functions: **A, B, C, E**
(Function Key on pages 212-213)

NOTES: Seat depth adjustment.

DIMENSIONS

Depth: 28¾
Width: 23
Height: 38¼
Seat Depth: 18
Seat Width: 20
Back Width: 16¼
Back Height: 17¾
Seat to Floor Height: 14⅞-19¾
Usable Seat Depth: 16⅝-18⅝
Ship Weight: 30
Cube: 7.8
COM: 1.0
Weight Rating: 300 lbs.

FABRIC PRICE CODES

| | | | |
|---|-------|----|-------|
| 1 | \$322 | 8 | \$460 |
| 2 | \$346 | 9 | \$478 |
| 3 | \$370 | 10 | \$496 |
| 4 | \$388 | 11 | \$514 |
| 5 | \$406 | 12 | \$532 |
| 6 | \$424 | L | — |
| 7 | \$442 | | |

H5902



TASK

Pneumatic
Back Height
Swivel
Tilt
Tilt Tension
Tilt Lock
Functions: **A, B, E, F, K, L**
(Function Key on pages 212-213)

DIMENSIONS

Depth: 27¾
Width: 23
Height: 39¾
Seat Depth: 18
Seat Width: 20
Back Width: 16¼
Back Height: 21
Seat to Floor Height: 17-22
Usable Seat Depth: 16¾
Ship Weight: 30
Cube: 7.8
COM: 1.0
Weight Rating: 300 lbs.

FABRIC PRICE CODES

| | | | |
|---|-------|----|-------|
| 1 | \$344 | 8 | \$482 |
| 2 | \$368 | 9 | \$500 |
| 3 | \$392 | 10 | \$518 |
| 4 | \$410 | 11 | \$536 |
| 5 | \$428 | 12 | \$554 |
| 6 | \$446 | L | — |
| 7 | \$464 | | |

H5903



TASK

Pneumatic
Back Height
Swivel
Multi-task
Functions: **A, B, E, N**
(Function Key on pages 212-213)

DIMENSIONS

Depth: 34¼
Width: 24
Height: 40½
Seat Depth: 18
Seat Width: 20
Back Width: 16¼
Back Height: 20¼
Seat to Floor Height: 16¼-20⅞
Usable Seat Depth: 13¾-17
Ship Weight: 32
Cube: 7.8
COM: 1.0
Weight Rating: 300 lbs.

FABRIC PRICE CODES

| | | | |
|---|-------|----|-------|
| 1 | \$486 | 8 | \$624 |
| 2 | \$510 | 9 | \$642 |
| 3 | \$534 | 10 | \$660 |
| 4 | \$552 | 11 | \$678 |
| 5 | \$570 | 12 | \$696 |
| 6 | \$588 | L | — |
| 7 | \$606 | | |

HON Recommendation: H5901.H.CU__T with optional H5995 - List Price \$450

HOW TO SPECIFY

| | | | |
|--|---|--|--|
| <p>Select Model Number</p> <p>H 5 9 0 1 .</p> | <p>Select Caster/Glide</p> <p>H Black Hard Caster S Black All-Surface Caster (+ \$40)</p> <p>H .</p> | <p>Select Fabric</p> <p>See page 260</p> <p>C U 1 0 .</p> | <p>Select Frame</p> <p>T Black</p> <p>T</p> |
|--|---|--|--|

COMFORTASK® 5900 Series

GSA SIN 33721



Icon Legend on page 17

H5905



TASK STOOL

Pneumatic
Back Height
Swivel
Adjustable Height Footring
Functions: **A, B, E**
(Function Key on pages 212-213)

DIMENSIONS

| | | | |
|--------------|-----|-----------------------|----------|
| Depth: | 30 | Seat to Floor Height: | 21¾-31⅞ |
| Width: | 26¾ | Footring Width: | 20 |
| Height: | 49¾ | Footring Height: | 12-14½ |
| Seat Depth: | 18 | Usable Seat Depth: | 17 |
| Seat Width: | 20 | Ship Weight: | 34 |
| Back Width: | 16¼ | Cube: | 10.4 |
| Back Height: | 17¾ | COM: | 1.0 |
| | | Weight Rating: | 300 lbs. |

FABRIC PRICE CODES

| | | | |
|----------|--------------|-----------|--------------|
| 1 | \$469 | 8 | \$607 |
| 2 | \$493 | 9 | \$625 |
| 3 | \$517 | 10 | \$643 |
| 4 | \$535 | 11 | \$661 |
| 5 | \$553 | 12 | \$679 |
| 6 | \$571 | L | — |
| 7 | \$589 | | |

NOTES: Available with optional Bell Glides.

H5991



T-ARMS

Fixed Position

DIMENSIONS

| | |
|-------------------|-----|
| Arm Width: | 18¾ |
| Height from Seat: | 8½ |
| Ship Weight: | 6 |
| Cube: | 1.0 |

LIST PRICE

\$88

H5995



ADJUSTABLE HEIGHT ARMS

Functions: **Q**
(Function Key on pages 212-213)

DIMENSIONS

| | |
|-------------------|-------|
| Arm Width: | 18¾ |
| Height from Seat: | 6½-8¾ |
| Ship Weight: | 8 |
| Cube: | 0.6 |

LIST PRICE

\$128

HOW TO SPECIFY

| | | | |
|--|---|--|---|
| <p>Select Model Number</p> <p>H 5 9 0 5 .</p> | <p>Select Caster/Glide</p> <p>H Black Hard Caster S Black All-Surface Caster (+ \$40)</p> <p>G Bell Glide (+ \$25) <i>Specify for model H5905 only</i></p> <p>H .</p> | <p>Select Fabric</p> <p>See page 260</p> <p>C U 1 0 .</p> | <p>Select Frame</p> <p>T Black</p> <p>T</p> |
|--|---|--|---|

CONVERGENCE®

Want to see more? Scan here
to check out hon.com.



Convergence® Task Chairs shown with
Empower® Height-Adjustable Workstations.

CONVERGENCE®

What happens when support and affordability come together? Convergence. This is the task chair that is as attainable as is it comfortable with customizable features. Lumbar support that adds a little extra lower back comfort. Thick seat cushions to take the stress off the lower body throughout the day. Arm choices that let you decide how much upper body support you want. A breathable mesh back that flexes and responds to your movements. Convergence puts all the features you're looking for into one low-priced task chair.



FEATURES

- Choice of swivel tilt or synchro-tilt control with seat slide.
- Black mesh back is breathable for all-day comfort and support.
- Comfort options include adjustable lumbar support, adjustable arms, seat glide and synchro-tilt.
- Three arm options.
- Two control options.
- Integrated handle on the back makes it easy to move and reposition the chair.
- Hard casters move effortlessly on any surface.
- Black frame sits atop a durable five-star base.
- Warranted for users up to 275 lbs.
- 3" thick seat cushion.

SEATING

CONVERGENCE®

Options

BACK OPTIONS

HCT1MM



Mid-back

Mesh Task Chair
with Adjustable
Lumbar Support

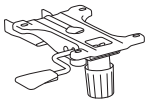
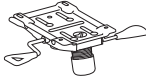
| MECHANISM | CODE | FUNCTIONS | PRICE |
|--|-----------|---|--------------|
|  | Z1 | Swivel-Tilt Control A, E, F, K, L, W | +\$0 |
|  | Y1 | Limited Synchro-Tilt A, D, E, J, K, L, W | +\$35 |

(See pages 212-213 for Seating Functions.)

| ARM STYLE | CODE | DESCRIPTION | PRICE |
|--|----------|-------------------------------------|--------------|
|  | N | Armless | +\$0 |
|  | H | Height-Adjustable Arms | +\$55 |
|  | A | Height and Width Adjustable Arms | +\$85 |

| CASTERS | CODE | DESCRIPTION | PRICE |
|--|----------|-------------------|-------------|
|  | H | Black Hard Caster | +\$0 |

| BACK STYLE | CODE | DESCRIPTION | PRICE |
|---|----------|-------------|-------------|
|  | M | Mesh | +\$0 |

| BASE | CODE | DESCRIPTION | PRICE |
|--|-----------|---------------|-------------|
|  | SB | Standard Base | +\$0 |

| LUMBAR | CODE | DESCRIPTION | PRICE |
|---|-----------|-------------------|-------------|
|  | AL | Adjustable Lumbar | +\$0 |

| FRAME | CODE | DESCRIPTION | PRICE |
|-------|----------|-------------|-------------|
| | T | Black | +\$0 |

HON BRANDED FABRICS

GRADE 1

Apex
Attire
Centurion
Compass
Contourett
Dapper
Ensemble
Hamilton
Inertia
Optic
Pebble

GRADE 2

Appoint Seating
Blume
Clyde
Dotty
Rush
Seed
Spin
Whisper Vinyl

GRADE 3

In Season
Moxie
Parker
Purl
Quill

For a complete list of fabrics, including partnership fabrics, go to hon.com/fabricsandfinishes.

Reference Fabric Color Combinations on pages 18-22 for color codes and legend on page 19 for lead times. For additional HON to Supply COM fabric grade pricing, go to honready.hon.com and click on the HON to Supply COM link.

CONVERGENCE®

Standard Task Chairs

OPEN MARKET



Icon Legend on page 17

HCT1MM



MID-BACK TASK

Mesh Back
 Pneumatic
 Swivel
 Tilt Tension
 Tilt Lock
 Adjustable Lumbar Support
 Functions: **A, E, K, L, W**
 (Function Key on pages 212-213)

DIMENSIONS

Depth: 27½
 Width: 27¾
 Height: 42
 Seat Depth: 19
 Seat Width: 20
 Back Width: 18
 Back Height: 22
 Adjustable Arms Width: 20
 Seat to Floor Height: 15¾-20
 Usable Seat Depth: 17-19
 Ship Weight: 44
 Cube: 5.8
 COM: 1.0
 Weight Rating: 275 lbs.

FABRIC PRICE CODES

| | | | |
|---|-------|----|-------|
| 1 | \$364 | 7 | \$424 |
| 2 | \$376 | 8 | \$433 |
| 3 | \$388 | 9 | \$442 |
| 4 | \$397 | 10 | \$451 |
| 5 | \$406 | 11 | \$460 |
| 6 | \$415 | 12 | \$469 |

NOTES: Arm width adjustment range is 3" (from 17"-20"). Lumbar adjustment is 3". Seat depth range is only for Y1 control. Seat depth on Z1 control is 19".

HSCASTER

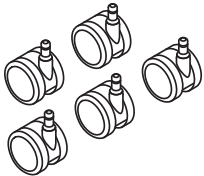

SET OF 5 ALL-SURFACE CASTERS

DIMENSIONS

Size: 60mm
 Ship Weight: 2.9
 Cube: 0.1

LIST PRICE

\$59

! Available in Black finish only, no specification needed.

HON Recommendation: HCT1MM.Y1.A.H.M.CU10.AL.SB.T - List Price \$484

SEATING

HOW TO SPECIFY

| Select Model Number | Select Control Type | Select Arm Type | Select Caster | Select Back Type | Select Upholstery | Select Lumbar | Select Base | Select Frame |
|---|--|-----------------------------|---------------|------------------|-----------------------------|-------------------------|----------------|--------------|
| Z1 Swivel-Tilt Control Y1 Simple Synchro-Tilt w/ Seat Slide Control (+ \$35) | N Armless H Height-Adjustable Arms (+ \$55) A Height & Width Adjustable Arms (+ \$85) | H Black Hard Casters | M Mesh | See page 265 | AL Adjustable Lumbar | SB Standard Base | T Black | |
| HCT1MM | Y1 | A | H | M | CU10 | AL | SB | T |



Icon Legend on page 17

CONVERGENCE® Value Task Chairs

HCAT1MM



MID-BACK TASK VALUE MODEL

Mesh Back

- Pneumatic
- Swivel
- Tilt Tension
- Tilt Lock
- Adjustable Lumbar Support

Functions: **A, E, K, L, W**
(Function Key on pages 212-213)

NOTES: Lumbar adjustment is 3". Seat depth range is only for Y1 control. Seat depth on Z1 control is 19".

DIMENSIONS

| | | | |
|--------------|-----|------------------------|----------|
| Depth: | 27½ | Adjustable Arms Width: | 17-20 |
| Width: | 27¾ | Seat to Floor Height: | 15¾-20 |
| Height: | 42 | Usable Seat Depth: | 17-19 |
| Seat Depth: | 19 | Ship Weight: | 44 |
| Seat Width: | 20 | Cube: | 5.8 |
| Back Width: | 18 | Weight Rating: | 275 lbs. |
| Back Height: | 22 | | |

LIST PRICE

\$420

HSCASTER

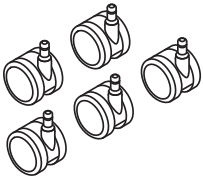

SET OF 5 ALL-SURFACE CASTERS

DIMENSIONS

| | |
|--------------|------|
| Size: | 60mm |
| Ship Weight: | 2.9 |
| Cube: | 0.1 |

LIST PRICE

\$59

ⓘ Available in Black finish only, no specification needed.

HON Recommendation: HCAT1MM.Z1.A.H.M.ACCF10.AL.SB.T - List Price \$420

HOW TO SPECIFY

| Select Model Number | Select Control Type | Select Arm Type | Select Caster | Select Back Type | Select Upholstery | Select Lumbar | Select Base | Select Frame |
|---------------------|---|---|-----------------------------|------------------|---------------------|-----------------------------|-------------------------|----------------|
| | Z1 Swivel-Tilt Control Y1 Simple Synchro-Tilt w/ Seat Slide Control (+ \$35) | A Height & Width Adjustable Arms | H Black Hard Casters | M Mesh | ACCF10 Black | AL Adjustable Lumbar | SB Standard Base | T Black |
| H C A T 1 M M . | Y 1 . | A . | H . | M . | A C C F 1 0 . | A L . | S B . | T |

CORRAL™ Contemporary Lounge

OPEN MARKET



Icon Legend on page 17

HVL887

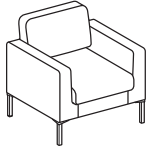

CLUB CHAIR

DIMENSIONS

| | | | |
|--------------|-----|-----------------------|-------------|
| Depth: | 28 | Arm Width: | 22¼ |
| Width: | 31½ | Seat to Floor Height: | 17⅞ |
| Height: | 30½ | Usable Seat Depth: | 19¾ |
| Seat Depth: | 19¾ | Ship Weight: | 51 Ⓢ |
| Seat Width: | 22¼ | Cube: | 8.9 |
| Back Width: | 22¼ | Weight Rating: | 250 lbs. |
| Back Height: | 17½ | | |

PRICE CODE

Leather **\$1079**

NOTES: Legs available in Platinum. Legs and back ship unattached. Pair with contemporary occasional tables on page 269. **HON 5-Year Limited Warranty.**

ⓘ Available in SB11 Black Bonded Leather only.

HON Recommendation: HVL887.SB11 - List Price \$1079

HVL888

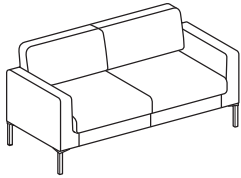

SOFA

DIMENSIONS

| | | | |
|--------------|-----|-----------------------|----------|
| Depth: | 28 | Arm Width: | 55 |
| Width: | 67 | Seat to Floor Height: | 17⅞ |
| Height: | 30½ | Usable Seat Depth: | 19¾ |
| Seat Depth: | 19¾ | Ship Weight: | 78 |
| Seat Width: | 55 | Cube: | 18.3 |
| Back Width: | 55 | Weight Rating: | 250 lbs. |
| Back Height: | 17½ | | |

PRICE CODE

Leather **\$1384**

NOTES: Legs available in Platinum. Legs and back ship unattached. Pair with contemporary occasional tables on page 269. **HON 5-Year Limited Warranty.**

ⓘ Available in SB11 Black Bonded Leather only.

HON Recommendation: HVL888.SB11 - List Price \$1384

SEATING

HOW TO SPECIFY

Select
Model Number

Select
Fabric

SB11 Black Bonded Leather

H V L 8 8 7 .

S B 1 1



CONTEMPORARY OCCASIONAL TABLES

HML8851

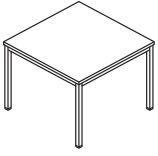

LAMINATE CORNER TABLE DIMENSIONS

| | | | |
|--------|----|--------------|-----|
| Depth: | 24 | Ship Weight: | 24 |
| Width: | 24 | Cube: | 1.7 |

LIST PRICE

\$216

NOTES: Metal leg occasional tables available in Black laminate. Choose from Corner or Coffee Table options. **HON 5-Year Limited Warranty.**

HON Recommendation: HML8851.P - List Price \$216

HML8852

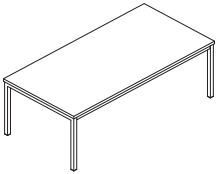

LAMINATE COFFEE TABLE DIMENSIONS

| | | | |
|--------|----|--------------|-----|
| Depth: | 24 | Ship Weight: | 38 |
| Width: | 48 | Cube: | 3.1 |

LIST PRICE

\$270

NOTES: Metal leg occasional tables available in Black laminate. Choose from Corner or Coffee Table options. **HON 5-Year Limited Warranty.**

HON Recommendation: HML8852.P - List Price \$270

HOW TO SPECIFY

| | |
|----------------------------|------------------------|
| Select Model Number | Select Laminate |
| H M L 8 8 5 1 . | P Black |
| | P |

CRIO™ Mesh Chairs

OPEN MARKET



Icon Legend on page 17

HVL581



HIGH-BACK

Pneumatic
Swivel
Tilt
Tilt Tension
Tilt Lock
Height and Width Adjustable
Arms
Adjustable Lumbar

Functions: **A, E, F, K, L, S, W**
(Function Key on pages 212-213)

NOTES: Comfortable and breathable mesh back. Black fabric or Black Bonded Leather. Black frame. Height and width adjustable arms. Adjustable lumbar. **HON 5-Year Limited Warranty.**

HON Recommendation: HVL581.ES10.T - List Price \$409

DIMENSIONS

| | | | |
|-------------|-----|-----------------------|----------|
| Depth: | 25½ | Arm Width: | 19⅞ |
| Width: | 28¾ | Seat to Floor Height: | 16½-20¼ |
| Height: | 42⅞ | Usable Seat Depth: | 17¼ |
| Seat Depth: | 17¼ | Ship Weight: | 39.8 |
| Seat Width: | 20¼ | Cube: | 4.8 |
| Back Width: | 18½ | Weight Rating: | 250 lbs. |

PRICE CODE

| | |
|----------------|--------------|
| Fabric | \$409 |
| Leather | \$434 |

HVL582



HIGH-BACK

Pneumatic
Swivel
Tilt
Tilt Tension
Tilt Lock
Asynchronous Control
Seat Glide Mechanism
Adjustable Lumbar
Height and Width Adjustable
Arms

Functions: **A, E, F, L, O, S, W**
(Function Key on pages 212-213)

NOTES: Comfortable and breathable mesh back. Black fabric or Black Bonded Leather. Black frame. Height and width adjustable arms. Seat glide mechanism. Asynchronous control with independent seat and back angle adjustment. Adjustable lumbar. **HON 5-Year Limited Warranty.**

HON Recommendation: HVL582.ES10.T - List Price \$504

DIMENSIONS

| | | | |
|-------------|-----|-----------------------|----------|
| Depth: | 27½ | Arm Width: | 19⅞ |
| Width: | 28¾ | Seat to Floor Height: | 20½-22⅞ |
| Height: | 43¾ | Usable Seat Depth: | 17¼ |
| Seat Depth: | 17¼ | Ship Weight: | 50.4 |
| Seat Width: | 19⅞ | Cube: | 6.8 |
| Back Width: | 18½ | Weight Rating: | 250 lbs. |

PRICE CODE

| | |
|----------------|--------------|
| Fabric | \$504 |
| Leather | \$529 |

HVL585



EXECUTIVE BIG AND TALL

Pneumatic
Swivel
Tilt
Tilt Tension
Tilt Lock
Height and Width Adjustable
Arms
Adjustable Lumbar

Functions: **A, E, F, K, L, S, W**
(Function Key on pages 212-213)

NOTES: Large scale model HVL585 will support 450 lbs with normal use. Black fabric. Black frame. Height and width adjustable arms. Adjustable lumbar. **HON 5-Year Limited Warranty.**

ⓘ Available in Black fabric only.

HON Recommendation: HVL585.ES10.T - List Price \$709

DIMENSIONS

| | | | |
|-------------|-----|-----------------------|----------|
| Depth: | 29⅞ | Arm Width: | 20½ |
| Width: | 28¾ | Seat to Floor Height: | 17⅞-21¾ |
| Height: | 45⅞ | Usable Seat Depth: | 19⅞ |
| Seat Depth: | 19⅞ | Ship Weight: | 55.4 |
| Seat Width: | 22 | Cube: | 7.2 |
| Back Width: | 20⅞ | Weight Rating: | 450 lbs. |

PRICE CODE

| | |
|---------------|--------------|
| Fabric | \$709 |
|---------------|--------------|

SEATING

HOW TO SPECIFY

Select
Model Number

H V L 5 8 1 .

Select
Fabric

ES10 Black
SB11 Black Bonded Leather
Available on HVL581 and HVL582 only

E S 1 0 .

Select
Frame

T Black

T



DEFINE™ Executive Chairs

HVL108



HIGH-BACK

Pneumatic
Swivel
Synchro-tilt
Height-adjustable Arms
Functions: **A, E, J, K, Q**
(Function Key on pages 212-213)

DIMENSIONS

| | | | |
|--------------|-----|-----------------------|----------|
| Depth: | 29¾ | Arm Width: | 19½ |
| Width: | 29¾ | Seat to Floor Height: | 17⅞-21⅜ |
| Height: | 46⅞ | Usable Seat Depth: | 17½ |
| Seat Depth: | 17½ | Ship Weight: | 47.3 |
| Seat Width: | 21 | Cube: | 7.2 |
| Back Width: | 20 | Weight Rating: | 250 lbs. |
| Back Height: | 26½ | | |

PRICE CODE

Leather \$657

NOTES: Available in Black Bonded Leather. Polished base. Polished arm accents. Height-adjustable arms. **HON 5-Year Limited Warranty.**

HON Recommendation: HVL108.SB11 - List Price \$657

SEATING

HOW TO SPECIFY

| | |
|----------------------------|----------------------------------|
| Select Model Number | Select Fabric |
| | SB11 Black Bonded Leather |
| H V L 1 0 8 . | S B 1 1 |

ENDORSE® COLLECTION

Want to see more? Scan here
to check out hon.com.



Endorse® Mid-Back Task Chair
shown with Preside® Conference Table.

ENDORSE® COLLECTION

You need inviting, comfy seats up front, and task chairs that support productivity in workstations. Achieve harmony throughout your space with a multi-functional collection of Endorse task seating. Endorse supports the diversity of applications throughout your workplace with sophisticated design. Varied options. Diverse materials. Simply pick the model that suits your space and people. Add the options that fit your needs. Then get ready to Endorse a higher level of productivity.

SEATING



TASK CHAIR FEATURES

- Available in high-, mid- and low-back options.
- Available in three different back materials — upholstered, mesh and plastic outer back.
- Comfort options include adjustable lumbar support, adjustable arms, seat glide, multi-position tilt and synchro-tilt.
- Optional seat slide adjustment adapts to users of various heights.
- Control options include limited synchro-tilt, advanced synchro-tilt, advanced synchro-tilt with independent back angle and weight-activated control.
- Arm options include fixed, armless, height- and width-adjustable and all-adjustable.
- Caster options include hard, All-Surface and roll control.
- Available in hundreds of quality HON fabrics.
- Warranted for users up to 300 lbs.
(450 lbs. for Big and Tall chairs)

BACK OPTIONS

HLEU
HLEUBT - Big & Tall



High-back

Upholstered with Adjustable Lumbar Support

HLWU
HLWUBT - Big & Tall



Mid-back

Upholstered with Adjustable Lumbar Support

HLWM
HLWMBT - Big & Tall

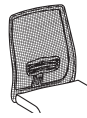

Mid-back

Mesh with Adjustable Lumbar Support

HLTU
HLTSU - Stool



Low-back

Upholstered with Adjustable Lumbar Support

HLTM
HLTSM - Stool



Low-back

Mesh with Adjustable Lumbar Support

HLTP
HLTSP - Stool



Low-back

Upholstered with Plastic Outer Back and Adjustable Lumbar Support

MESH BACK COLOR CODES (no upcharge): Black - **IM** Breeze - **IB** Brownstone - **IK** Charcoal - **IC** Fog - **IF** Regatta - **IR** Titanium - **IT**

MECHANISM

| MECHANISM | CODE | FUNCTIONS | PRICE |
|-----------|-----------|---|---------------|
| | S0 | Limited Recline Synchro-Tilt A, E, J, K, L | +\$0 |
| | S1 | Limited Recline Synchro-Tilt w/ Seat Slider (available on Stools only) A, D, E, J, K, L | +\$20 |
| | Y2 | Advanced Synchro-Tilt A, D, E, J, L, W, A-D | +\$65 |
| | Y3 | Advanced Synchro-Tilt with Independent Back Angle A, D, E, J, L, W, A-E | +\$105 |
| | Y4 | Synchro-Tilt A, D, E, J, L, W, A-D (Big and Tall models only) | +\$0 |
| | W5 | Weight-Activated A, D, E, L, W, A-D | +\$150 |

(See pages 212-213 for Seating Functions.)

BASE

| BASE | CODE | DESCRIPTION | PRICE |
|------|-----------|-------------------|---------------|
| | SB | Standard Base | +\$0 |
| | PA | Polished Aluminum | +\$110 |

ARM STYLE

| ARM STYLE | CODE | DESCRIPTION | PRICE |
|-----------|----------|--------------------------------------|---------------|
| | N | Armless | +\$0 |
| | F | Fixed - Black | +\$65 |
| | A | Height and Width Adjustable Arms | +\$85 |
| | V | All-Adjustable Arms - includes pivot | +\$130 |
| | P | Fixed - Polished Alum. | +\$175 |

CASTERS

| CASTERS | CODE | DESCRIPTION | PRICE |
|---------|----------|--|--------------|
| | A | Black All-Surface Caster (High-back and Big and Tall models only) | +\$0 |
| | H | Black Hard Caster | +\$0 |
| | S | Black All-Surface Caster | +\$40 |
| | R | Black Roll Control Caster | +\$50 |

ENDORSE® Dimensions

TASK DIMENSIONS

| MODEL | | HLEU | HLWU | HLWM | HLTU | HLTM | HLTP |
|-------------------------|-----|---------|---------|---------|---------|---------|---------|
| Overall Width Armless | | 28½ | 28½ | 28½ | 28½ | 28½ | 28½ |
| Overall Width with Arms | A/V | 28½ | 28½ | 28½ | 28½ | 28½ | 28½ |
| | F/P | 28½ | 28½ | 28½ | 28½ | 28½ | 28½ |
| Overall Depth | | 28½ | 28½ | 28½ | 28½ | 28½ | 28½ |
| Overall Height | S0 | 49 | 45½ | 45½ | 42 | 42 | 42 |
| | Y2 | 49¾ | 46¼ | 46¼ | 42¾ | 42¾ | 42¾ |
| | Y3 | 49½ | 46 | 46 | 42½ | 42½ | 42½ |
| | W5 | 49 | 48⅜ | 48⅜ | 43 | 43 | 43 |
| Seat Width | | 20 | 20 | 20 | 19 | 19 | 19 |
| Seat Depth | | 18½ | 18½ | 18½ | 18⅝ | 18⅝ | 18⅝ |
| Usable Seat Depth | S0 | 17¾ | 17¾ | 17¾ | 17⅝ | 17⅝ | 17⅝ |
| | Y2 | 15½-18 | 15½-18 | 15½-18 | 15½-18 | 15½-18 | 15½-18 |
| | Y3 | 15¼-18¼ | 15¼-18¼ | 15¼-18¼ | 15¼-18¼ | 15¼-18¼ | 15¼-18¼ |
| | W5 | 15½-17¾ | 15½-17¾ | 15½-17¾ | 15½-17¾ | 15½-17¾ | 15½-17¾ |
| Seat Height (mechanism) | S0 | 17-21½ | 17-21½ | 17-21½ | 17-21½ | 17-21½ | 17-21½ |
| | Y2 | 17¾-22¼ | 17¾-22¼ | 17¾-22¼ | 17¾-22¼ | 17¾-22¼ | 17¾-22¼ |
| | Y3 | 17½-22 | 17½-22 | 17½-22 | 17½-22 | 17½-22 | 17½-22 |
| | W5 | 17¼-21¾ | 17¼-21¾ | 17¼-21¾ | 17¼-21¾ | 17¼-21¾ | 17¼-21¾ |
| Back Width | | 21⅝ | 21¼ | 19¼ | 19¾ | 18 | 19¾ |
| Back Height | | 29¾ | 25 | 25 | 22¾ | 21¼ | 22¾ |
| Ship Weight Armless | S0 | 52 | 43 | 40 | 49 | 41 | 50 |
| | Y2 | 57 | 48 | 45 | 54 | 46 | 56 |
| | Y3 | 60 | 52 | 48 | 58 | 50 | 59 |
| | W5 | 56 | 47 | 44 | 54 | 45 | 55 |
| Weight with Arms | S0 | 60 | 51 | 48 | 57 | 49 | 58 |
| | Y2 | 65 | 56 | 53 | 62 | 54 | 64 |
| | Y3 | 68 | 60 | 56 | 66 | 58 | 67 |
| | W5 | 64 | 55 | 52 | 62 | 53 | 63 |
| Between Arms | A/V | 17½-20 | 17½-20 | 17½-20 | 16¾-19¼ | 16¾-19¼ | 16¾-19¼ |
| | F/P | 20½ | 20½ | 20½ | 20½ | 20½ | 20½ |
| COM | | 2.0 | 2.0 | 1.0 | 2.0 | 1.0 | 2.0 |
| Weight Capacity | | 300 lbs | 300 lbs | 300 lbs | 300 lbs | 300 lbs | 300 lbs |

BIG & TALL & STOOL DIMENSIONS

| MODEL | | HLEUBT | HLWUBT | HLWMBT | HLTSU | HLTSM | HLTSP |
|-------------------------|-------|---------|---------|---------|---------|---------|---------|
| Overall Width Armless | | 28½ | 28½ | 28½ | 28½ | 28½ | 28½ |
| Overall Width with Arms | A/V | 28½ | 28½ | 28½ | 28½ | 28½ | 28½ |
| | F/P | 28½ | 28½ | 28½ | 28½ | 28½ | 28½ |
| Overall Depth | | 28½ | 28½ | 28½ | 28½ | 28½ | 28½ |
| Overall Height | S0/S1 | - | - | - | 53 | 53 | 53 |
| | Y4 | 49 | 49 | 49 | - | - | - |
| Seat Width | | 23 | 23 | 23 | 19 | 19 | 19 |
| Seat Depth | S0/S1 | - | - | - | 18⅝ | 18⅝ | 18⅝ |
| | Y4 | 20¼ | 20¼ | 20¼ | - | - | - |
| Usable Seat Depth | S0 | - | - | - | 17⅝ | 17⅝ | 17⅝ |
| | S1 | - | - | - | 15¼-18¼ | 15¼-18¼ | 15¼-18¼ |
| | Y4 | 17¾-19¼ | 17¾-19¼ | 17¼-18¾ | - | - | - |
| Seat Height (mechanism) | S0/S1 | - | - | - | 22¾-32¾ | 22¾-32¾ | 22¾-32¾ |
| | Y4 | 17½-22 | 17½-22 | 17½-22 | - | - | - |
| Back Width | | 23¼ | 23½ | 22½ | 19¾ | 19¾ | 19¾ |
| Back Height | | 28¼ | 25 | 25¾ | 22¾ | 22¾ | 22¾ |
| Ship Weight Armless | S0 | - | - | - | 50 | 42 | 51 |
| | S1 | - | - | - | 52 | 44 | 53 |
| | Y4 | 57 | 57 | 57 | - | - | - |
| Weight with Arms | S0 | - | - | - | 58 | 50 | 59 |
| | S1 | - | - | - | 60 | 52 | 61 |
| | Y4 | 65 | 65 | 65 | - | - | - |
| Between Arms | A/V | 20½-23 | 20½-23 | 20½-23 | 16¾-19¼ | 16¾-19¼ | 16¾-19¼ |
| | F/P | 23½ | 23½ | 23½ | 20½ | 20½ | 20½ |
| COM | | 2.0 | 2.0 | 1.5 | 2.0 | 2.0 | 2.0 |
| Weight Capacity | | 450 lbs | 450 lbs | 450 lbs | 300 lbs | 300 lbs | 300 lbs |

HON BRANDED FABRICS *(For Seating)*

GRADE 1

Apex
Attire
Centurion
Compass
Contourett
Dapper
Ensemble
Hamilton
Inertia
Optic
Pebble

GRADE 2

Appoint Seating
Blume
Clyde
Dotty
Rush
Seed
Spin Seating
Whisper Vinyl

GRADE 3

In Season
Moxie
Parker
Purl
Quill

For a complete list of fabrics, including partnership fabrics, go to hon.com/fabricsandfinishes.

Reference Fabric Color Combinations on pages 18-22 for color codes and legend on page 19 for lead times. For additional HON to Supply COM fabric grade pricing, go to honready.hon.com and click on the HON to Supply COM link.



HLEU

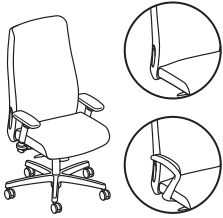

EXECUTIVE HIGH-BACK

Upholstered Back

- Pneumatic
- Swivel
- Synchro-tilt
- Tilt Tension
- Tilt Lock
- Integral Lumbar Support
- Optional Seat Glide

Functions: **A, E, J, K, L, W**
(Function Key on pages 212-213)

! See page 274 for additional specifications and dimensions.

DIMENSIONS

| | | | |
|-------------|-----|----------------|----------|
| Depth: | 31½ | Back Width: | 21⅝ |
| Width: | 31½ | Back Height: | 29¾ |
| Height: | 47¾ | Cube: | 16.0 |
| Seat Depth: | 15¾ | COM: | 2.0 |
| Seat Width: | 19¾ | Weight Rating: | 300 lbs. |

FABRIC PRICE CODES

| | | | |
|----------|---------------|-----------|---------------|
| 1 | \$860 | 8 | \$1136 |
| 2 | \$908 | 9 | \$1172 |
| 3 | \$956 | 10 | \$1208 |
| 4 | \$992 | 11 | \$1244 |
| 5 | \$1028 | 12 | \$1280 |
| 6 | \$1064 | L | — |
| 7 | \$1100 | | |

HON Recommendation: HLEU.Y2.A.A.CU__SB - List Price \$1010

HOW TO SPECIFY

| Select Model Number | Select Control Type | Select Arm Type | Select Caster/Glide | Select Fabric | Select Base |
|---|--|--|---------------------|---|-------------|
| <p>S0 Limited Recline Synchro-Tilt</p> <p>Y2 Advanced Synchro-Tilt (+ \$65)</p> <p>Y3 Synchro-Tilt with Independent Back Angle (+ \$105)</p> <p>W5 Weight-Activated (+ \$150)</p> | <p>N Armless</p> <p>F Fixed Arms - Black (+ \$65)</p> <p>A Height and Width Adjustable Arms (+ \$85)</p> <p>V All-Adjustable Arms (includes pivot) (+ \$130)</p> <p>P Fixed Arms - Polished (+ \$175)</p> | <p>A Black All-Surface Caster</p> | <p>See page 275</p> | <p>SB Standard Base</p> <p>PA Polished Aluminum (+ \$110)</p> | |
| HLEU | Y2 | A | A | CU10 | SB |



Icon Legend on page 17

HLWU

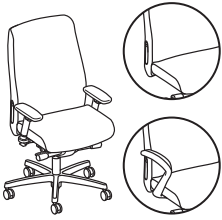

TASK MID-BACK

Upholstered Back

- Pneumatic
- Swivel
- Synchro-tilt
- Tilt Tension
- Tilt Lock
- Integral Lumbar Support
- Optional Seat Glide

Functions: **A, E, J, K, L, W**
(Function Key on pages 212-213)

! See page 274 for additional specifications and dimensions.

DIMENSIONS

| | | | |
|-------------|-----|----------------|----------|
| Depth: | 28½ | Back Width: | 21¼ |
| Width: | 28½ | Back Height: | 25 |
| Height: | 44½ | Cube: | 10.8 |
| Seat Depth: | 15¾ | COM: | 2.0 |
| Seat Width: | 19¾ | Weight Rating: | 300 lbs. |

FABRIC PRICE CODES

| | | | |
|----------|---------------|-----------|---------------|
| 1 | \$827 | 8 | \$1103 |
| 2 | \$875 | 9 | \$1139 |
| 3 | \$923 | 10 | \$1175 |
| 4 | \$959 | 11 | \$1211 |
| 5 | \$995 | 12 | \$1247 |
| 6 | \$1031 | L | — |
| 7 | \$1067 | | |

HLWM



TASK MID-BACK

4-Way Stretch Back

- Pneumatic
- Swivel
- Synchro-tilt
- Tilt Tension
- Tilt Lock
- Integral Lumbar Support
- Optional Seat Glide

Functions: **A, E, J, K, L, W**
(Function Key on pages 212-213)

NOTES: For Mesh Back models, specify the 4-Way Stretch back option below. Headrest available on Mid-back 4-Way Stretch models only - Black only.

! See page 274 for additional specifications and dimensions.

DIMENSIONS

| | | | |
|-------------|-----|----------------|----------|
| Depth: | 28½ | Back Width: | 19 |
| Width: | 28½ | Back Height: | 25 |
| Height: | 44½ | Cube: | 10.8 |
| Seat Depth: | 15¾ | COM: | 1.0 |
| Seat Width: | 19¾ | Weight Rating: | 300 lbs. |

FABRIC PRICE CODES

| | | | |
|----------|--------------|-----------|---------------|
| 1 | \$827 | 8 | \$965 |
| 2 | \$851 | 9 | \$983 |
| 3 | \$875 | 10 | \$1001 |
| 4 | \$893 | 11 | \$1019 |
| 5 | \$911 | 12 | \$1037 |
| 6 | \$929 | L | — |
| 7 | \$947 | | |

HON Recommendation: HLWM.Y2.A.H.IM.CU__SB.N - List Price \$977

HOW TO SPECIFY

| Select Model Number | Select Control Type | Select Arm Type | Select Caster/Glide | Select Mesh Back | Select Fabric | Select Base | Select Headrest |
|---|---|---|--|------------------|--|---|-----------------|
| S0 Limited Recline Y2 Synchro-Tilt Y3 Advanced Synchro-Tilt (+ \$65) Y3 Synchro-Tilt with Independent Back Angle (+ \$105) W5 Weight-Activated (+ \$150) | N Armless F Fixed Arms - Black (+ \$65) A Height and Width Adjustable Arms (+ \$85) V All-Adjustable Arms (includes pivot) (+ \$130) P Fixed Arms - Polished (+ \$175) | H Black Hard Caster S Black All-Surface Caster (+ \$40) R Black Roll Control Caster (+ \$50) | IM Black IB Breeze IK Brownstone IC Charcoal IF Fog IR Regatta IT Titanium <i>Specify the back for Mesh Back models only</i> | See page 275 | SB Standard Base PA Polished Aluminum (+ \$110) | N No Headrest HR Headrest (+ \$80) <i>Black only. Specify for model HLWM only</i> | |
| HLWM | Y2 | A | H | IM | CU10 | SB | N |

ENDORSE®



Icon Legend on page 17

HLTU

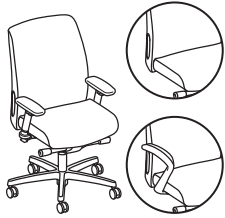

TASK LOW-BACK

Upholstered Back

- Pneumatic
- Swivel
- Synchro-tilt
- Tilt Tension
- Tilt Lock
- Integral Lumbar Support
- Optional Seat Glide

Functions: **A, E, J, K, L, W**
(Function Key on pages 212-213)

! Do not need to specify back option for Upholstered Back models. See page 274 for additional specifications and dimensions.

DIMENSIONS

| | | | |
|-------------|-----|----------------|----------|
| Depth: | 28½ | Back Width: | 19¾ |
| Width: | 28½ | Back Height: | 22¾ |
| Height: | 41¼ | Cube: | 10.8 |
| Seat Depth: | 15½ | COM: | 2.0 |
| Seat Width: | 18¾ | Weight Rating: | 300 lbs. |

FABRIC PRICE CODES

| | | | |
|----------|---------------|-----------|---------------|
| 1 | \$769 | 8 | \$1045 |
| 2 | \$817 | 9 | \$1081 |
| 3 | \$865 | 10 | \$1117 |
| 4 | \$901 | 11 | \$1153 |
| 5 | \$937 | 12 | \$1189 |
| 6 | \$973 | L | — |
| 7 | \$1009 | | |

HLTM



TASK LOW-BACK

4-Way Stretch Back

- Pneumatic
- Swivel
- Synchro-tilt
- Tilt Tension
- Tilt Lock
- Integral Lumbar Support
- Optional Seat Glide

Functions: **A, E, J, K, L, W**
(Function Key on pages 212-213)

NOTES: For Mesh Back models, specify the 4-Way Stretch back option below.

! See page 274 for additional specifications and dimensions.

DIMENSIONS

| | | | |
|-------------|-----|----------------|----------|
| Depth: | 28½ | Back Width: | 17¾ |
| Width: | 28½ | Back Height: | 21¾ |
| Height: | 40¼ | Cube: | 10.8 |
| Seat Depth: | 15½ | COM: | 1.0 |
| Seat Width: | 18¾ | Weight Rating: | 300 lbs. |

FABRIC PRICE CODES

| | | | |
|----------|--------------|-----------|--------------|
| 1 | \$769 | 8 | \$907 |
| 2 | \$793 | 9 | \$925 |
| 3 | \$817 | 10 | \$943 |
| 4 | \$835 | 11 | \$961 |
| 5 | \$853 | 12 | \$979 |
| 6 | \$871 | L | — |
| 7 | \$889 | | |

HLTP

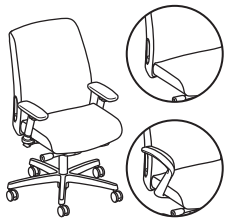

TASK LOW-BACK

Plastic Outer Back

- Pneumatic
- Swivel
- Synchro-tilt
- Tilt Tension
- Tilt Lock
- Integral Lumbar Support
- Optional Seat Glide

Functions: **A, E, J, K, L, W**
(Function Key on pages 212-213)

! Do not need to specify back option for Plastic Outer Back models. See page 274 for additional specifications and dimensions.

DIMENSIONS

| | | | |
|-------------|-----|----------------|----------|
| Depth: | 28½ | Back Width: | 19¾ |
| Width: | 28½ | Back Height: | 22¾ |
| Height: | 41¼ | Cube: | 10.8 |
| Seat Depth: | 15½ | COM: | 2.0 |
| Seat Width: | 18¾ | Weight Rating: | 300 lbs. |

FABRIC PRICE CODES

| | | | |
|----------|---------------|-----------|---------------|
| 1 | \$833 | 8 | \$1109 |
| 2 | \$881 | 9 | \$1145 |
| 3 | \$929 | 10 | \$1181 |
| 4 | \$965 | 11 | \$1217 |
| 5 | \$1001 | 12 | \$1253 |
| 6 | \$1037 | L | — |
| 7 | \$1073 | | |

HON Recommendation: HLTM.Y2.A.H.IM.CU__SB - List Price \$919

HOW TO SPECIFY

| Select Model Number | Select Control Type | Select Arm Type | Select Caster/Glide | Select Mesh Back | Select Fabric | Select Base |
|---------------------|--|---|---|---|---------------|--|
| HLTM | <ul style="list-style-type: none"> S0 Limited Recline Synchro-Tilt Y2 Advanced Synchro-Tilt (+ \$65) Y3 Synchro-Tilt with Independent Back Angle (+ \$105) W5 Weight-Activated (+ \$150) | <ul style="list-style-type: none"> N Armless F Fixed Arms - Black (+ \$65) A Height and Width Adjustable Arms (+ \$85) V All-Adjustable Arms (includes pivot) (+ \$130) P Fixed Arms - Polished (+ \$175) | <ul style="list-style-type: none"> H Black Hard Caster S Black All-Surface Caster (+ \$40) R Black Roll Control Caster (+ \$50) | <ul style="list-style-type: none"> 4-Way Stretch options IM Black IB Breeze IK Brownstone IC Charcoal IF Fog IR Regatta IT Titanium <p><i>Specify the back for Mesh Back models only</i></p> | See page 275 | <ul style="list-style-type: none"> SB Standard Base PA Polished Aluminum (+ \$110) |
| HLTM | Y2 | A | H | IM | CU10 | SB |



Icon Legend on page 17

HLWUBT

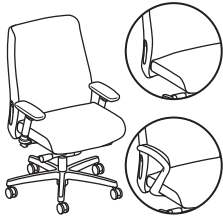

TASK MID-BACK

Big and Tall Upholstered Back
 Pneumatic
 Seat-glide
 Swivel
 Synchro-tilt
 Tilt Lock
 Side Tilt Tension
 Integral Lumbar Support

DIMENSIONS

Depth: 31½
 Width: 31½
 Height: 44⅝
 Seat Depth: 21
 Seat Width: 23
 Back Width: 23½
 Back Height: 25
 Adjustable Arms Width: 21½-23¾
 Fixed Arms Width: 24
 Seat to Floor Height: 18-22
 Usable Seat Depth: 17¾-19¼
 Ship Weight: 65
 Cube: 15.3
 COM: 2.0
 Weight Rating: 450 lbs.

FABRIC PRICE CODES

| | | | |
|---|--------|----|--------|
| 1 | \$1374 | 8 | \$1650 |
| 2 | \$1422 | 9 | \$1686 |
| 3 | \$1470 | 10 | \$1722 |
| 4 | \$1506 | 11 | \$1758 |
| 5 | \$1542 | 12 | \$1794 |
| 6 | \$1578 | L | — |
| 7 | \$1614 | | |

Functions: **A, D, E, A-D, J, L, W**
 (Function Key on pages 212-213)

! Do not need to specify back option for Upholstered Back models.

HLWMBT

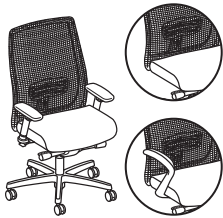

TASK MID-BACK

Big and Tall 4-Way Stretch Back
 Pneumatic
 Seat-glide
 Swivel
 Synchro-tilt
 Tilt Lock
 Side Tilt Tension
 Integral Lumbar Support

DIMENSIONS

Depth: 31½
 Width: 31½
 Height: 44⅝
 Seat Depth: 21
 Seat Width: 23
 Back Width: 22½
 Back Height: 25¾
 Adjustable Arms Width: 21½-23¾
 Fixed Arms Width: 24
 Seat to Floor Height: 18-22
 Usable Seat Depth: 17¼-18¾
 Ship Weight: 75
 Cube: 15.3
 COM: 1.5
 Weight Rating: 450 lbs.

FABRIC PRICE CODES

| | | | |
|---|--------|----|--------|
| 1 | \$1374 | 8 | \$1581 |
| 2 | \$1410 | 9 | \$1608 |
| 3 | \$1446 | 10 | \$1635 |
| 4 | \$1473 | 11 | \$1662 |
| 5 | \$1500 | 12 | \$1689 |
| 6 | \$1527 | L | — |
| 7 | \$1554 | | |

Functions: **A, D, E, A-D, J, L, W**
 (Function Key on pages 212-213)

NOTES: For Mesh Back models, specify the 4-Way Stretch back option below. Headrest available on Mid-back 4-Way Stretch models only - Black only.

HLEUBT

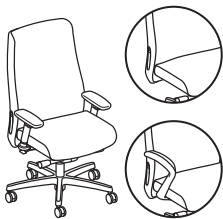

EXECUTIVE HIGH-BACK

Big and Tall Upholstered Back
 Pneumatic
 Seat-glide
 Swivel
 Synchro-tilt
 Tilt Lock
 Side Tilt Tension
 Integral Lumbar Support

DIMENSIONS

Depth: 31½
 Width: 31½
 Height: 46⅝
 Seat Depth: 21
 Seat Width: 23
 Back Width: 23¼
 Back Height: 28¼
 Adjustable Arms Width: 21½-23¾
 Fixed Arms Width: 24
 Seat to Floor Height: 18-22
 Usable Seat Depth: 17¾-19¼
 Ship Weight: 74
 Cube: 16.0
 COM: 2.0
 Weight Rating: 450 lbs.

FABRIC PRICE CODES

| | | | |
|---|--------|----|--------|
| 1 | \$1407 | 8 | \$1683 |
| 2 | \$1455 | 9 | \$1719 |
| 3 | \$1503 | 10 | \$1755 |
| 4 | \$1539 | 11 | \$1791 |
| 5 | \$1575 | 12 | \$1827 |
| 6 | \$1611 | L | — |
| 7 | \$1647 | | |

Functions: **A, D, E, A-D, J, L, W**
 (Function Key on pages 212-213)

! Executive High-back Big and Tall models are available with an upholstered back only.

HON Recommendation: HLWMBT.Y4.A.A.IM.CU__SB.N - List Price \$1459

HOW TO SPECIFY

| Select Model Number | Select Control Type | Select Arm Type | Select Caster/Glide | Select Mesh Back | Select Fabric | Select Base | Select Headrest |
|---------------------|--|--|----------------------------|--|---------------|------------------|---|
| HLWMBT | Y4 <i>Y4 is the only control option for the Big and Tall models</i> | N Armless F Fixed Arms - Black (+ \$65) A Height and Width Adjustable Arms (+ \$85) V All-Adjustable Arms (includes pivot) (+ \$130) P Fixed Arms - Polished (+ \$175) | A Black All-Surface Caster | 4-Way Stretch option <i>Black only</i> IM Black <i>Specify the back for Mesh Back models only</i> | See page 275 | SB Standard Base | N No Headrest HR Headrest (+ \$80) <i>Black only. Specify for model HLWMBT only</i> |
| HLWMBT | Y4 | A | A | IM | CU10 | SB | N |

ENDORSE®



Icon Legend on page 17

HLTSU



STOOL

- Upholstered Back**
- Pneumatic
- Swivel
- Synchro-tilt
- Tilt Tension
- Tilt Lock
- Integral Lumbar Support

Functions: **A, E, J, K, L, W**
(Function Key on pages 212-213)

Do not need to specify back option for Upholstered Back models. See page 274 for additional specifications and dimensions.

DIMENSIONS

| | | | |
|-------------|-----|----------------|----------|
| Depth: | 28½ | Back Width: | 19¾ |
| Width: | 28½ | Back Height: | 22¾ |
| Height: | 53½ | Cube: | 10.8 |
| Seat Depth: | 15½ | COM: | 2.0 |
| Seat Width: | 18¾ | Weight Rating: | 300 lbs. |

FABRIC PRICE CODES

| | | | |
|----------|---------------|-----------|---------------|
| 1 | \$918 | 8 | \$1194 |
| 2 | \$966 | 9 | \$1230 |
| 3 | \$1014 | 10 | \$1266 |
| 4 | \$1050 | 11 | \$1302 |
| 5 | \$1086 | 12 | \$1338 |
| 6 | \$1122 | L | — |
| 7 | \$1158 | | |

HLTSM



STOOL

- 4-Way Stretch Back**
- Pneumatic
- Swivel
- Synchro-tilt
- Tilt Tension
- Tilt Lock
- Integral Lumbar Support

Functions: **A, E, J, K, L, W**
(Function Key on pages 212-213)

NOTES: For Mesh Back models, specify the 4-Way Stretch back option below. See page 274 for additional specifications and dimensions.

DIMENSIONS

| | | | |
|-------------|-----|----------------|----------|
| Depth: | 28½ | Back Width: | 17¾ |
| Width: | 28½ | Back Height: | 21¾ |
| Height: | 52½ | Cube: | 10.8 |
| Seat Depth: | 15½ | COM: | 1.0 |
| Seat Width: | 18¾ | Weight Rating: | 300 lbs. |

FABRIC PRICE CODES

| | | | |
|----------|---------------|-----------|---------------|
| 1 | \$918 | 8 | \$1056 |
| 2 | \$942 | 9 | \$1074 |
| 3 | \$966 | 10 | \$1092 |
| 4 | \$984 | 11 | \$1110 |
| 5 | \$1002 | 12 | \$1128 |
| 6 | \$1020 | L | — |
| 7 | \$1038 | | |

HLTSP



STOOL

- Plastic Outer Back**
- Pneumatic
- Swivel
- Synchro-tilt
- Tilt Tension
- Tilt Lock
- Integral Lumbar Support

Functions: **A, E, J, K, L, W**
(Function Key on pages 212-213)

Do not need to specify back option for Outer Back models. See page 274 for additional specifications and dimensions.

DIMENSIONS

| | | | |
|-------------|-----|----------------|----------|
| Depth: | 28½ | Back Width: | 19¾ |
| Width: | 28½ | Back Height: | 22¾ |
| Height: | 52½ | Cube: | 10.8 |
| Seat Depth: | 15½ | COM: | 2.0 |
| Seat Width: | 18¾ | Weight Rating: | 300 lbs. |

FABRIC PRICE CODES

| | | | |
|----------|---------------|-----------|---------------|
| 1 | \$982 | 8 | \$1258 |
| 2 | \$1030 | 9 | \$1294 |
| 3 | \$1078 | 10 | \$1330 |
| 4 | \$1114 | 11 | \$1366 |
| 5 | \$1150 | 12 | \$1402 |
| 6 | \$1186 | L | — |
| 7 | \$1222 | | |

HON Recommendation: HLTSM.S1.A.H.IM.CU__SB - List Price \$1023

HOW TO SPECIFY

| Select Model Number | Select Control Type | Select Arm Type | Select Caster/Glide | Select Mesh Back | Select Fabric | Select Base |
|---|--|--|--|------------------|---|-------------|
| <p>S0 Limited Recline Synchro-Tilt</p> <p>S1 Limited Recline Synchro-Tilt w/ Seat Slider (+ \$20)</p> | <p>N Armless</p> <p>F Fixed Arms - Black (+ \$65)</p> <p>A Height and Width Adjustable Arms (+ \$85)</p> <p>V All-Adjustable Arms (includes pivot) (+ \$130)</p> <p>P Fixed Arms - Polished (+ \$175)</p> | <p>H Black Hard Caster</p> <p>S Black All-Surface Caster (+ \$40)</p> <p>R Black Roll Control Caster (+ \$50)</p> | <p>4-Way Stretch options</p> <p>IM Black</p> <p>IB Breeze</p> <p>IK Brownstone</p> <p>IC Charcoal</p> <p>IF Fog</p> <p>IR Regatta</p> <p>IT Titanium</p> <p><i>Specify the back for Mesh Back models only</i></p> | See page 275 | <p>SB Standard Base</p> <p>PA Polished Aluminum (+ \$110)</p> | |
| HLTSM | S1 | A | H | IM | CU10 | SB |



Icon Legend on page 17

HL2DARM

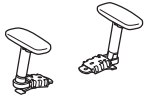

ADJUSTABLE T-ARMS

Height and Width
Functions: **S**
(Function Key on pages 212-213)

DIMENSIONS

Adjustable Arms Width: 16³/₄-19¹/₄
Height from Seat: 7¹/₄-11
Ship Weight: 8
Cube: 1.0

LIST PRICE

\$138

! Available in Black only. No need to specify.

HL4DARM



ALL-ADJUSTABLE ARMS

Height, Width, Depth and Pivot

DIMENSIONS

Adjustable Arms Width: 16³/₄-19¹/₄
Height from Seat: 7¹/₄-11
Ship Weight: 8
Cube: 1.0

LIST PRICE

\$185

! Available in Black only. No need to specify.

HI2FHA



FIXED HEIGHT ARMS

DIMENSIONS

Arm Width: 20
Height from Seat: 9¹/₂
Ship Weight: 7
Cube: 1.0

LIST PRICE

\$122

HIPAA

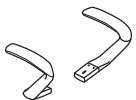

POLISHED ALUMINUM ARMS

Fixed Height

DIMENSIONS

Arm Width: 20
Height from Seat: 9¹/₂
Ship Weight: 10
Cube: 1.0

LIST PRICE

\$201

HLMSHHR



MESH HEADREST

DIMENSIONS

Mesh Width: 12
Mesh Height: 6
Ship Weight: 3
Cube: 1.0

QA DIMENSIONS

(Attachment Mechanism)

Width: 12
Depth: 6
Height: 12

LIST PRICE

\$153

! Available in Black Mesh (IM) only. For use with Mesh Mid-back models only.

HSCASTER

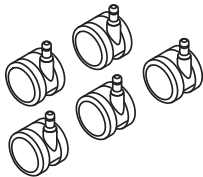

SET OF 5 ALL-SURFACE CASTERS

DIMENSIONS

Size: 60mm
Ship Weight: 2
Cube: 0.1

LIST PRICE

\$59

! Available in Black finish only, no specification needed.

OPEN MARKET

ENTIRE™ Mesh Chairs

OPEN MARKET



Icon Legend on page 17

HVL541



HIGH-BACK

Pneumatic
Swivel
Tilt
Tilt Tension
Tilt Lock
Adjustable Lumbar
Height-adjustable Arms

Functions: **A, E, F, K, L, Q, W**
(Function Key on pages 212-213)

DIMENSIONS

| | | | |
|--------------|--------------------------------|-----------------------|--|
| Depth: | 28 ³ / ₈ | Arm Width: | 19 ³ / ₄ |
| Width: | 28 ³ / ₈ | Seat to Floor Height: | 17 ³ / ₄ -22 ¹ / ₂ |
| Height: | 43 ³ / ₈ | Usable Seat Depth: | 19 ¹ / ₄ |
| Seat Depth: | 19 ¹ / ₄ | Ship Weight: | 44 |
| Seat Width: | 19 ⁵ / ₈ | Cube: | 4.0 |
| Back Width: | 16 ³ / ₄ | Weight Rating: | 250 lbs. |
| Back Height: | 22 ³ / ₄ | | |

PRICE CODE

Fabric **\$467**

NOTES: Comfortable and breathable mesh back. Black fabric seat. Black frame. Height-adjustable arms. **HON 5-Year Limited Warranty.**

HON Recommendation: HVL541.LH10 - List Price \$467

SEATING

HOW TO SPECIFY

Select
Model Number

H V L 5 4 1 .

Select
Fabric

LH10 Black Fabric

L H 1 0



Icon Legend on page 17

EXPOSURE™ Mesh Chairs

HVL721



HIGH-BACK

Pneumatic
Swivel
Synchronized Tilt
Tilt Tension
Tilt Lock
Seat Glide Mechanism
Adjustable Lumbar
Height and Width Adjustable
Arms

Functions: **A, D, E, J, K, L, S, W**
(Function Key on pages 212-213)

DIMENSIONS

| | | | |
|--------------|---------|-----------------------|----------|
| Depth: | 26¾ | Arm Width: | 16½-18¾ |
| Width: | 26½ | Seat to Floor Height: | 18¼-22¾ |
| Height: | 42½ | Usable Seat Depth: | 17½-19½ |
| Seat Depth: | 17½-19½ | Ship Weight: | 40 |
| Seat Width: | 19½ | Cube: | 5.5 |
| Back Width: | 18½ | Weight Rating: | 250 lbs. |
| Back Height: | 24¼ | | |

PRICE CODE

Fabric **\$641**

NOTES: Available in Black fabric with Black accents. Comfortable and breathable mesh back. Adjustable seat glide mechanism. Height and width adjustable arms. Adjustable lumbar support. **HON 5-Year Limited Warranty.**

HON Recommendation: HVL721.LH10 - List Price \$641

HOW TO SPECIFY

| | |
|----------------------------|----------------------|
| Select Model Number | Select Fabric |
| | LH10 Black Fabric |
| H V L 7 2 1 . | L H 1 0 |



Flock® Seating and Tables.

FLOCK®

Break away. Come together. Wherever people migrate within a space, Flock is designed to support their needs. With a full collection of modular and comfortable seating elements and coordinating collaborative tables that work seamlessly together, you can make the most of every square inch of your space. Modular lounge chairs and ottomans stand alone or combine to create large arrangements. Multi-purpose stools and chairs add comfort to open spaces. Collaborative tables that bring the whole group together. Flock helps people interact with each other, challenge one another, and receive the support they need.

SEATING



CHAIR FEATURES

- Round and square lounge chairs are fully-upholstered.
- The contemporary aesthetic easily matches a variety of surroundings.
- Support everything from one-on-one conversations to large meetings.
- Choose from four leg options — standard, tapered round, tapered square, hard casters, or a 4-star base.
- Swivel, X-, or 4-star base options include return-to-center feature.
- Available in hundreds of quality HON fabrics.
- Warranted for users up to 300 lbs.

COLLABORATIVE TABLES

- Choose from round, square, rectangle or racetrack shaped table tops.
- Optional grommets neatly route cords.
- Bases available in disc, T-leg and X-leg styles.
- Choose bases with or without footings.

MODEL OPTIONS

HFLSC1
HFLSC1DF - Multi-Fabric

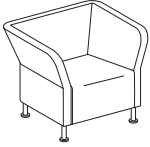

Lounge Chair
Square

HFLRC1
HFLRC1DF - Multi-Fabric

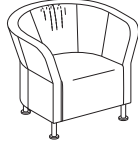

Lounge Chair
Round

HFLMC1
HFLMC1DF - Multi-Fabric



Modular Chair

HFLML1
HFLML1DF - Multi-Fabric

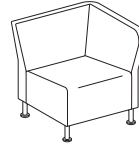

Modular
Left End

HFLMR1
HFLMR1DF - Multi-Fabric

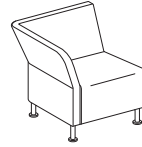

Modular
Right End

HFLCC1
HFLCC1DF - Multi-Fabric

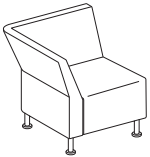

True Chair
Corner

HFLW145
HFLW145DF - Multi-Fabric

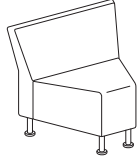

Wedge
Inside

HFLW045
HFLW045DF - Multi-Fabric

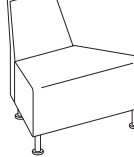

Wedge
Outside

HFL450

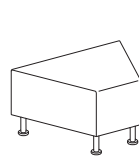

Wedge Ottoman

HFLSC1S
HFLSC1SDF - Multi-Fabric

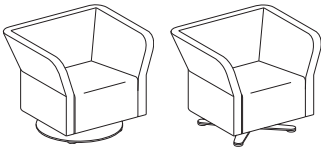

Square Lounge Chair
Swivel Base or X-Base

HFLRC1S
HFLRC1SDF - Multi-Fabric

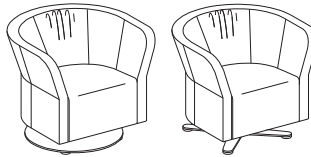

Round Lounge Chair
Swivel Base or X-Base

HFLMC1S
HFLMC1SDF - Multi-Fabric

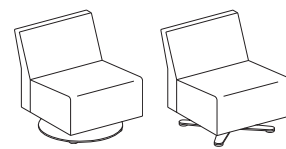

Modular Chair
Swivel Base or X-Base

LEG STYLE



| CODE | DESCRIPTION | PRICE |
|----------|--------------|-------------|
| L | Standard Leg | +\$0 |



| | | |
|-----------|----------------|-------------|
| TS | Tapered Square | +\$0 |
|-----------|----------------|-------------|



| | | |
|-----------|---------------|-------------|
| TR | Tapered Round | +\$0 |
|-----------|---------------|-------------|



| | | |
|----------|--------------|-------------|
| H | Hard Casters | +\$0 |
|----------|--------------|-------------|

LEG COLOR

| CODE | DESCRIPTION | PRICE |
|------------|-------------------|-------------|
| PR8 | Textured Silver | +\$0 |
| P7A | Textured Charcoal | +\$0 |

**Specify PR8 & P7A for Standard Legs and Tapered Round & Tapered Square Legs only*

| | | |
|----------|-------------------|-------------|
| T | Black Hard Caster | +\$0 |
|----------|-------------------|-------------|

**Specify for Hard Caster option only*

FLOCK® Options

MODEL OPTIONS

HFLB2

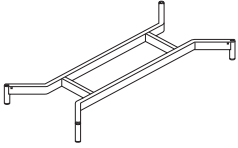

Two-Seat Base Frame

HFLB3

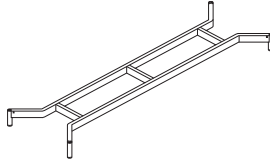

Three-Seat Base Frame

HTSSRD



Tapered Square
Leg - Shroud Pack

COMPATIBLE MODELS

HFLMC1
HFLMC1DF - Multi-Fabric



Modular Chair

HFLML1
HFLML1DF - Multi-Fabric

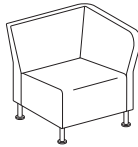

Modular
Left End

HFLMR1
HFLMR1DF - Multi-Fabric

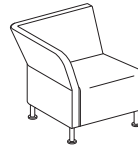

Modular
Right End

HFLCC1
HFLCC1DF - Multi-Fabric

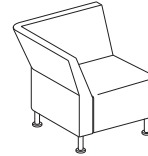

True Chair
Corner

HFLSO1

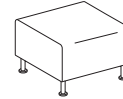

Square Ottoman

LEG STYLE



| CODE | DESCRIPTION | PRICE |
|-----------|--------------------|-------------|
| RS | Round Straight Leg | +\$0 |

Available in the following finishes:

| | |
|------------|-------------------|
| PR8 | Textured Silver |
| P7A | Textured Charcoal |



| | | |
|-----------|----------------|--------------|
| TS | Tapered Square | +\$75 |
|-----------|----------------|--------------|

Available in the following finishes:

| | |
|------------|-------------------|
| PR8 | Textured Silver |
| P7A | Textured Charcoal |

HON BRANDED FABRICS

| GRADE 1 | GRADE 2 | GRADE 3 | GRADE L |
|------------|-----------------|-----------|-----------------|
| Apex | Appoint Seating | In Season | Denver Leather* |
| Attire | Blume | Moxie | |
| Centurion | Clyde | Parker | |
| Compass | Dotty | Purl | |
| Contourett | Rush | Quill | |
| Dapper | Seed | | |
| Ensemble | Spin Seating | | |
| Hamilton | Whisper Vinyl | | |
| Inertia | | | |
| Optic | | | |
| Pebble | | | |

For a complete list of fabrics, including partnership fabrics, go to hon.com/fabricsandfinishes.

Flock® chair model HFLRC1 has fabric limitations, please see the Flock® seating pages 288-297 for details.

Reference Fabric Color Combinations on pages 18-22 for color codes and legend on page 19 for lead times.

*Denver Leather (SS) may not be available on every model within a specific series, please refer to the model's page for details.

❗ Due to the inherent characteristics of upholstery materials, the seat of Flock® may become more relaxed to show wrinkles over time.

FLOCK® ROUND LOUNGE HFLRC1/DF HON BRANDED FABRICS

| GRADE 1 | GRADE 2 | GRADE 3 | GRADE L |
|------------|-----------------|-----------|------------------|
| Apex | Appoint Seating | In Season | Denver Leather** |
| Centurion | Blume | Moxie | |
| Compass | Clyde | Parker | |
| Contourett | Rush | Purl | |
| Dapper | Seed* | Quill | |
| Ensemble | Spin Seating* | | |
| Hamilton | Whisper Vinyl | | |
| Inertia | | | |
| Optic | | | |
| Pebble | | | |

For a complete list of fabrics, including partnership fabrics, go to hon.com/fabricsandfinishes.

Reference Fabric Color Combinations on pages 18-22 for color codes and legend on page 19 for lead times.

*Available on seat only.

**Denver Leather (SS) may not be available on every model within a specific series, please refer to the model's page for details.

❗ Due to the inherent characteristics of upholstery materials, the seat of Flock® may become more relaxed to show wrinkles over time.



HFLSC1

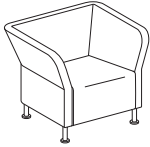

LOUNGE CHAIR

Square

DIMENSIONS

| | | | |
|--------------|-----|-----------------------|----------|
| Depth: | 28½ | Arm Width: | 27½ |
| Width: | 34¼ | Seat to Floor Height: | 17 |
| Height: | 28 | Usable Seat Depth: | 20½ |
| Seat Depth: | 20½ | Ship Weight: | 79 |
| Seat Width: | 21½ | Cube: | 21.9 |
| Back Width: | 21½ | COM: | 5.0 |
| Back Height: | 18½ | Weight Rating: | 300 lbs. |

FABRIC PRICE CODES

| | | | |
|----------|---------------|-----------|---------------|
| 1 | \$1973 | 8 | \$2594 |
| 2 | \$2081 | 9 | \$2675 |
| 3 | \$2189 | 10 | \$2756 |
| 4 | \$2270 | 11 | \$2837 |
| 5 | \$2351 | 12 | \$2918 |
| 6 | \$2432 | L | \$2873 |
| 7 | \$2513 | | |

! Leg options – Standard Leg (L), Tapered Square (TS) and Tapered Round (TR) are available in Textured Silver (PR8) and Textured Charcoal (P7A) only. Hard Casters (H) are available on Black (T) only.

HFLRC1



Due to the inherent design of the Round Lounge chair, material gathers will be present in the back.

LOUNGE CHAIR

Round

DIMENSIONS

| | | | |
|--------------|-----|-----------------------|----------|
| Depth: | 29 | Arm Width: | 27½ |
| Width: | 33½ | Seat to Floor Height: | 17 |
| Height: | 28 | Usable Seat Depth: | 20½ |
| Seat Depth: | 20½ | Ship Weight: | 57 |
| Seat Width: | 20½ | Cube: | 21.9 |
| Back Width: | 20½ | Weight Rating: | 300 lbs. |
| Back Height: | 18½ | | |

FABRIC PRICE CODES

| | | | |
|----------|---------------|-----------|---------------|
| 1 | \$2061 | 8 | \$2613 |
| 2 | \$2157 | 9 | \$2685 |
| 3 | \$2253 | 10 | \$2757 |
| 4 | \$2325 | 11 | \$2829 |
| 5 | \$2397 | 12 | \$2901 |
| 6 | \$2469 | L | \$2861 |
| 7 | \$2541 | | |

! Round Lounge models HFLRC1 / HFLRC1DF are offered in select fabrics; for availability, please see the Fabric Matrix on page 287. Also approved in limited Partnership Fabrics. Leg options – Standard Leg (L), Tapered Square (TS) and Tapered Round (TR) are available in Textured Silver (PR8) and Textured Charcoal (P7A) only. Hard Casters (H) are available on Black (T) only.
! Customer's Own Material (COM) is not available on Flock® model HFLRC1.

HON Recommendation: HFLSC1.TS.PNS___.PR8 - List Price \$2081

HOW TO SPECIFY

| | | | |
|---|---|---|---|
| <p>Select Model Number</p> <p>HFLSC1</p> | <p>Select Leg Option</p> <p>L Standard Leg TS Tapered Square TR Tapered Round H Hard Casters</p> <p>TS</p> | <p>Select Fabric</p> <p>See page 287</p> <p>PNS007</p> | <p>Select Leg Color</p> <p>PR8 Textured Silver P7A Textured Charcoal</p> <p><i>Specify for Standard, Tapered Round and Tapered Square legs only</i></p> <p>T Black Hard Caster <i>Specify for Hard Caster option only</i></p> <p>PR8</p> |
|---|---|---|---|



HFLMC1

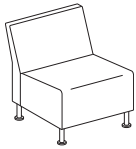

MODULAR CHAIR

DIMENSIONS

| | | | |
|--------------|-----|-----------------------|----------|
| Depth: | 28½ | Seat to Floor Height: | 17 |
| Width: | 25 | Usable Seat Depth: | 20½ |
| Height: | 28 | Ship Weight: | 54 |
| Seat Depth: | 20½ | Cube: | 21.9 |
| Seat Width: | 25 | COM: | 3.0 |
| Back Width: | 25 | Weight Rating: | 300 lbs. |
| Back Height: | 18½ | | |

FABRIC PRICE CODES

| | | | |
|---|--------|----|--------|
| 1 | \$1446 | 8 | \$1860 |
| 2 | \$1518 | 9 | \$1914 |
| 3 | \$1590 | 10 | \$1968 |
| 4 | \$1644 | 11 | \$2022 |
| 5 | \$1698 | 12 | \$2076 |
| 6 | \$1752 | L | \$2046 |
| 7 | \$1806 | | |

ⓘ Leg options – Standard Leg (L), Tapered Square (TS) and Tapered Round (TR) are available in Textured Silver (PR8) and Textured Charcoal (P7A) only. Hard Casters (H) are available on Black (T) only.

HFLML1

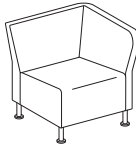

MODULAR

Left End

DIMENSIONS

| | | | |
|--------------|-----|-----------------------|----------|
| Depth: | 28½ | Seat to Floor Height: | 17 |
| Width: | 28½ | Usable Seat Depth: | 20½ |
| Height: | 28 | Ship Weight: | 72 |
| Seat Depth: | 20½ | Cube: | 21.9 |
| Seat Width: | 22¼ | COM: | 4.0 |
| Back Width: | 22¼ | Weight Rating: | 300 lbs. |
| Back Height: | 18½ | | |

FABRIC PRICE CODES

| | | | |
|---|--------|----|--------|
| 1 | \$1706 | 8 | \$2258 |
| 2 | \$1802 | 9 | \$2330 |
| 3 | \$1898 | 10 | \$2402 |
| 4 | \$1970 | 11 | \$2474 |
| 5 | \$2042 | 12 | \$2546 |
| 6 | \$2114 | L | \$2506 |
| 7 | \$2186 | | |

ⓘ Leg options – Standard Leg (L), Tapered Square (TS) and Tapered Round (TR) are available in Textured Silver (PR8) and Textured Charcoal (P7A) only. Hard Casters (H) are available on Black (T) only.

HFLMR1



MODULAR

Right End

DIMENSIONS

| | | | |
|--------------|-----|-----------------------|----------|
| Depth: | 28½ | Seat to Floor Height: | 17 |
| Width: | 28½ | Usable Seat Depth: | 20½ |
| Height: | 28 | Ship Weight: | 72 |
| Seat Depth: | 20½ | Cube: | 21.9 |
| Seat Width: | 22¼ | COM: | 4.0 |
| Back Width: | 22¼ | Weight Rating: | 300 lbs. |
| Back Height: | 18½ | | |

FABRIC PRICE CODES

| | | | |
|---|--------|----|--------|
| 1 | \$1706 | 8 | \$2258 |
| 2 | \$1802 | 9 | \$2330 |
| 3 | \$1898 | 10 | \$2402 |
| 4 | \$1970 | 11 | \$2474 |
| 5 | \$2042 | 12 | \$2546 |
| 6 | \$2114 | L | \$2506 |
| 7 | \$2186 | | |

ⓘ Leg options – Standard Leg (L), Tapered Square (TS) and Tapered Round (TR) are available in Textured Silver (PR8) and Textured Charcoal (P7A) only. Hard Casters (H) are available on Black (T) only.

HON Recommendation: HFLMC1.TS.PNS___.PR8 - List Price \$1518

HOW TO SPECIFY

| | | | |
|--|---|--|---|
| <p>Select Model Number</p> <p>H F L M C 1 .</p> | <p>Select Leg Option</p> <p>L Standard Leg TS Tapered Square TR Tapered Round H Hard Casters</p> <p>T S .</p> | <p>Select Fabric</p> <p>See page 287</p> <p>P N S 0 0 7 .</p> | <p>Select Leg Color</p> <p>PR8 Textured Silver P7A Textured Charcoal</p> <p><i>Specify for Standard, Tapered Round and Tapered Square legs only</i></p> <p>T Black Hard Caster <i>Specify for Hard Caster option only</i></p> <p>P R 8</p> |
|--|---|--|---|



HFLCC1

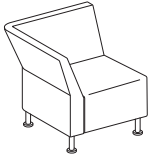

TRUE CORNER CHAIR

DIMENSIONS

| | | | |
|--------------|-----|-----------------------|----------|
| Depth: | 28½ | Seat to Floor Height: | 17 |
| Width: | 28½ | Usable Seat Depth: | 20½ |
| Height: | 28 | Ship Weight: | 60 |
| Seat Depth: | 20½ | Cube: | 21.9 |
| Seat Width: | 20½ | COM: | 4.0 |
| Back Width: | 22¼ | Weight Rating: | 300 lbs. |
| Back Height: | 18½ | | |

FABRIC PRICE CODES

| | | | |
|----------|---------------|-----------|---------------|
| 1 | \$1698 | 8 | \$2482 |
| 2 | \$1794 | 9 | \$2606 |
| 3 | \$1890 | 10 | \$2730 |
| 4 | \$1986 | 11 | \$2854 |
| 5 | \$2110 | 12 | \$2978 |
| 6 | \$2234 | L | \$2498 |
| 7 | \$2358 | | |

! Leg options – Standard Leg (L), Tapered Square (TS) and Tapered Round (TR) are available in Textured Silver (PR8) and Textured Charcoal (P7A) only.

HFLWI45

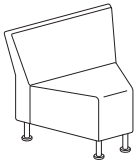

INSIDE WEDGE

DIMENSIONS

| | | | |
|--------------|-----|-----------------------|----------|
| Depth: | 26¼ | Seat to Floor Height: | 17 |
| Width: | 31½ | Usable Seat Depth: | 19 |
| Height: | 28 | Ship Weight: | 45 |
| Seat Depth: | 19½ | Cube: | 21.9 |
| Seat Width: | 25¾ | COM: | 3.0 |
| Back Width: | 31½ | Weight Rating: | 300 lbs. |
| Back Height: | 18½ | | |

FABRIC PRICE CODES

| | | | |
|----------|---------------|-----------|---------------|
| 1 | \$1696 | 8 | \$2480 |
| 2 | \$1792 | 9 | \$2604 |
| 3 | \$1888 | 10 | \$2728 |
| 4 | \$1984 | 11 | \$2852 |
| 5 | \$2108 | 12 | \$2976 |
| 6 | \$2232 | L | \$2496 |
| 7 | \$2356 | | |

! Leg options – Standard Leg (L), Tapered Square (TS) and Tapered Round (TR) are available in Textured Silver (PR8) and Textured Charcoal (P7A) only.

HFLWO45

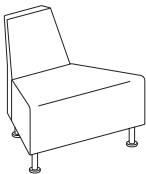

OUTSIDE WEDGE

DIMENSIONS

| | | | |
|--------------|-----|-----------------------|----------|
| Depth: | 26¼ | Seat to Floor Height: | 17 |
| Width: | 32 | Usable Seat Depth: | 19 |
| Height: | 28 | Ship Weight: | 35 |
| Seat Depth: | 19½ | Cube: | 21.9 |
| Seat Width: | 32 | COM: | 3.0 |
| Back Width: | 16¼ | Weight Rating: | 300 lbs. |
| Back Height: | 18½ | | |

FABRIC PRICE CODES

| | | | |
|----------|---------------|-----------|---------------|
| 1 | \$1696 | 8 | \$2480 |
| 2 | \$1792 | 9 | \$2604 |
| 3 | \$1888 | 10 | \$2728 |
| 4 | \$1984 | 11 | \$2852 |
| 5 | \$2108 | 12 | \$2976 |
| 6 | \$2232 | L | \$2496 |
| 7 | \$2356 | | |

! Leg options – Standard Leg (L), Tapered Square (TS) and Tapered Round (TR) are available in Textured Silver (PR8) and Textured Charcoal (P7A) only.

HON Recommendation: HFLCC1.TS.PNS__PR8 - List Price \$1698

HOW TO SPECIFY

| | | | |
|---|--|---|---|
| <p>Select Model Number</p> <p>HFLCC1</p> | <p>Select Leg Option</p> <p>L Standard Leg TS Tapered Square TR Tapered Round</p> <p>TS</p> | <p>Select Fabric</p> <p>See page 287</p> <p>PNS007</p> | <p>Select Leg Color</p> <p>PR8 Textured Silver P7A Textured Charcoal</p> <p><i>Specify for Standard, Tapered Round and Tapered Square legs only</i></p> <p>PR8</p> |
|---|--|---|---|



HFL450

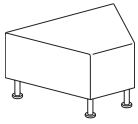

WEDGE OTTOMAN

DIMENSIONS

| | | | |
|-----------------------|-----|--------------------|----------|
| Depth: | 23½ | Usable Seat Depth: | 23½ |
| Width: | 32 | Ship Weight: | 33 |
| Height: | 17 | Cube: | 12.6 |
| Seat Depth: | 23½ | COM: | 2.0 |
| Seat Width: | 32 | Weight Rating: | 300 lbs. |
| Seat to Floor Height: | 17 | | |

FABRIC PRICE CODES

| | | | |
|----------|---------------|-----------|---------------|
| 1 | \$833 | 8 | \$1225 |
| 2 | \$881 | 9 | \$1287 |
| 3 | \$929 | 10 | \$1349 |
| 4 | \$977 | 11 | \$1411 |
| 5 | \$1039 | 12 | \$1473 |
| 6 | \$1101 | L | \$1233 |
| 7 | \$1163 | | |

ⓘ Leg options – Standard Leg (L), Tapered Square (TS) and Tapered Round (TR) are available in Textured Silver (PR8) and Textured Charcoal (P7A) only.

HFLS01

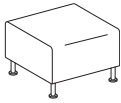

OTTOMAN

Square

DIMENSIONS

| | | | |
|-------------|----|----------------|----------|
| Depth: | 25 | Ship Weight: | 30.0 |
| Width: | 25 | Cube: | 7.5 |
| Height: | 17 | COM: | 2.0 |
| Seat Depth: | 25 | Weight Rating: | 300 lbs. |
| Seat Width: | 25 | | |

FABRIC PRICE CODES

| | | | |
|----------|---------------|-----------|---------------|
| 1 | \$845 | 8 | \$1121 |
| 2 | \$893 | 9 | \$1157 |
| 3 | \$941 | 10 | \$1193 |
| 4 | \$977 | 11 | \$1229 |
| 5 | \$1013 | 12 | \$1265 |
| 6 | \$1049 | L | \$1245 |
| 7 | \$1085 | | |

ⓘ Leg options – Standard Leg (L), Tapered Square (TS) and Tapered Round (TR) are available in Textured Silver (PR8) and Textured Charcoal (P7A) only. Hard Casters (H) are available on Black (T) only.

ⓘ While the top surface of the ottoman is flat, modular models (pages 289-290 and 294-296) have a slight angle to their seats. Therefore, there will not be alignment between these units when placed side-by-side.

HFLGANG



GANGING BRACKET

For Flock® Modular Seating Models

- Can be used for in-line ganging ONLY
- Use bracket set to connect two models. Do not connect more than four models.
- No specification required for bracket

DIMENSIONS

| | |
|--------------|-----|
| Ship Weight: | 0.5 |
| Cube: | 0.1 |

LIST PRICE

\$37

HON Recommendation: HFLS01.TS.PNS__PR8 - List Price \$893

HOW TO SPECIFY

| | | | |
|--|---|--|---|
| <p>Select Model Number</p> <p>H F L S 0 1 .</p> | <p>Select Leg Option</p> <p>L Standard Leg TS Tapered Square TR Tapered Round H Hard Casters</p> <p>T S .</p> | <p>Select Fabric</p> <p>See page 287</p> <p>P N S 0 0 7 .</p> | <p>Select Leg Color</p> <p>PR8 Textured Silver P7A Textured Charcoal</p> <p><i>Specify for Standard, Tapered Round and Tapered Square legs only</i></p> <p>T Black Hard Caster <i>Specify for Hard Caster option only</i></p> <p>P R 8</p> |
|--|---|--|---|



HFLSC1S

SQUARE LOUNGE CHAIR W/ SWIVEL BASE

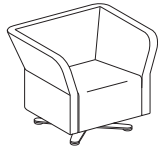

X-Base

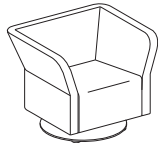

Disc Base

DIMENSIONS

| | | | |
|--------------|---------------------------------|---------------------------|--------------------------------|
| Depth: | 28 ⁹ / ₁₆ | Arm Width: | 27 ¹ / ₂ |
| Width: | 34 ⁵ / ₃₂ | Seat to Floor Height: | 17 |
| Height: | 28 | Usable Seat Depth: | 20 ¹ / ₂ |
| Seat Depth: | 20 ⁷ / ₃₂ | Ship Weight (X-base): | 116 |
| Seat Width: | 21 ¹ / ₂ | Ship Weight (Round base): | 148 |
| Back Width: | 21 ¹ / ₂ | Cube: | 21.9 |
| Back Height: | 18 ¹ / ₂ | COM: | 5.0 |
| | | Weight Rating: | 300 lbs. |

FABRIC PRICE CODES

| | | | |
|---|--------|----|--------|
| 1 | \$2567 | 8 | \$3188 |
| 2 | \$2675 | 9 | \$3269 |
| 3 | \$2783 | 10 | \$3350 |
| 4 | \$2864 | 11 | \$3431 |
| 5 | \$2945 | 12 | \$3512 |
| 6 | \$3026 | L | \$3467 |
| 7 | \$3107 | | |

HFLRC1S

ROUND LOUNGE CHAIR W/ SWIVEL BASE



X-Base

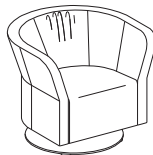

Disc Base

DIMENSIONS

| | | | |
|--------------|---------------------------------|---------------------------|--------------------------------|
| Depth: | 29 ¹ / ₁₆ | Arm Width: | 27 ¹ / ₂ |
| Width: | 33 ⁵ / ₃₂ | Seat to Floor Height: | 17 |
| Height: | 28 | Usable Seat Depth: | 20 ¹ / ₂ |
| Seat Depth: | 20 ¹ / ₂ | Ship Weight (X-base): | 94 |
| Seat Width: | 20 ¹ / ₂ | Ship Weight (Round base): | 126 |
| Back Width: | 20 ¹ / ₂ | Cube: | 21.9 |
| Back Height: | 18 ¹ / ₂ | Weight Rating: | 300 lbs. |

FABRIC PRICE CODES

| | | | |
|---|--------|----|--------|
| 1 | \$2662 | 8 | \$3214 |
| 2 | \$2758 | 9 | \$3286 |
| 3 | \$2854 | 10 | \$3358 |
| 4 | \$2926 | 11 | \$3430 |
| 5 | \$2998 | 12 | \$3502 |
| 6 | \$3070 | L | \$3462 |
| 7 | \$3142 | | |

- ! Round Lounge model HFLRC1S is offered in select fabrics; for availability please see Fabric matrix on page 287. Also approved in limited Partnership Fabrics. Base options are available in Textured Silver (PR8) and Textured Charcoal (P7A) only.
- ! Customer's Own Material (COM) is not available on HFLRC1S.

HFLMC1S

MODULAR CHAIR W/ SWIVEL BASE



X-Base



Disc Base

DIMENSIONS

| | | | |
|--------------|--------------------------------|---------------------------|--------------------------------|
| Depth: | 28 ¹ / ₂ | Seat to Floor Height: | 17 |
| Width: | 25 | Usable Seat Depth: | 20 ¹ / ₂ |
| Height: | 28 | Ship Weight (X-base): | 91 |
| Seat Depth: | 20 ¹ / ₂ | Ship Weight (Round base): | 123 |
| Seat Width: | 25 | Cube: | 21.9 |
| Back Width: | 25 | COM: | 3.0 |
| Back Height: | 18 ¹ / ₂ | Weight Rating: | 300 lbs. |

FABRIC PRICE CODES

| | | | |
|---|--------|----|--------|
| 1 | \$1906 | 8 | \$2320 |
| 2 | \$1978 | 9 | \$2374 |
| 3 | \$2050 | 10 | \$2428 |
| 4 | \$2104 | 11 | \$2482 |
| 5 | \$2158 | 12 | \$2536 |
| 6 | \$2212 | L | \$2506 |
| 7 | \$2266 | | |

HON Recommendation: HFLMC1S.X.PNS__PR8 - List Price \$1906

HOW TO SPECIFY

| | | | |
|---|---|---|---|
| Select Model Number H F L M C 1 S . | Select Swivel Option X X Base D Disc Base X . | Select Fabric See page 287 P N S 0 0 7 . | Select Base Color PR8 Textured Silver P7A Textured Charcoal P R 8 |
|---|---|---|---|



HFLSC1DF

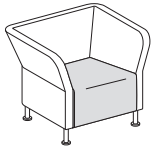

LOUNGE CHAIR

Multi-Fabric
Square

DIMENSIONS

| | | | |
|--------------|-----|-----------------------|--------------|
| Depth: | 28½ | Arm Width: | 27½ |
| Width: | 34¼ | Seat to Floor Height: | 17 |
| Height: | 28 | Usable Seat Depth: | 20½ |
| Seat Depth: | 20½ | Ship Weight: | 48 |
| Seat Width: | 21½ | Cube: | 27.0 |
| Back Width: | 21½ | COM: | See page 305 |
| Back Height: | 18½ | Weight Rating: | 300 lbs. |

FABRIC PRICE CODES

| | | |
|--------------------------------|---------------|--------------|
| 1 | \$2059 | |
| <i>Add to Base Price Above</i> | | |
| | Back | Seat |
| 2 | \$80 | \$28 |
| 3 | \$160 | \$56 |
| 4 | \$220 | \$77 |
| 5 | \$280 | \$98 |
| 6 | \$340 | \$119 |
| 7 | \$400 | \$140 |
| 8 | \$460 | \$161 |
| 9 | \$519 | \$183 |
| 10 | \$579 | \$204 |
| 11 | \$639 | \$225 |
| 12 | \$699 | \$246 |
| L | \$666 | \$234 |

For multi-fabric models, start with the base price, then add the additional amount for the back and seat from the corresponding matrix to determine the final list price. Choose any combination of fabric grades for the back and seat.

Example: HFLSC1DF base price (\$2059) + Grade 2 back fabric (add \$80) + Grade 4 seat fabric (add \$77) = Total \$2216 List
 HFLSC1DF base price (\$2059) + Grade 5 back fabric (add \$280) + Grade 3 seat fabric (add \$56) = Total \$2395 List

HFLRC1DF

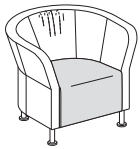

LOUNGE CHAIR

Multi-Fabric
Round

DIMENSIONS

| | | | |
|--------------|-----|-----------------------|----------|
| Depth: | 29 | Arm Width: | 27½ |
| Width: | 33½ | Seat to Floor Height: | 17 |
| Height: | 28 | Usable Seat Depth: | 20½ |
| Seat Depth: | 20½ | Ship Weight: | 39 |
| Seat Width: | 20½ | Cube: | 27.0 |
| Back Width: | 20½ | Weight Rating: | 300 lbs. |
| Back Height: | 18½ | | |

FABRIC PRICE CODES

| | | |
|--------------------------------|---------------|--------------|
| 1 | \$2148 | |
| <i>Add to Base Price Above</i> | | |
| | Back | Seat |
| 2 | \$71 | \$25 |
| 3 | \$142 | \$50 |
| 4 | \$195 | \$69 |
| 5 | \$249 | \$87 |
| 6 | \$302 | \$106 |
| 7 | \$355 | \$125 |
| 8 | \$408 | \$144 |
| 9 | \$462 | \$162 |
| 10 | \$515 | \$181 |
| 11 | \$568 | \$200 |
| 12 | \$622 | \$218 |
| L | \$592 | \$208 |

NOTES: Due to the inherent design of the Round Lounge chair, material gathers will be present in the back.
 ⓘ Round Lounge models HFLRC1 / HFLRC1DF are offered in select fabrics; for availability, please see the Fabric Matrix on page 287. Also approved in limited Partnership Fabrics.

For multi-fabric models, start with the base price, then add the additional amount for the back and seat from the corresponding matrix to determine the final list price. Choose any combination of fabric grades for the back and seat.

Example: HFLRC1DF base price (\$2148) + Grade 2 back fabric (add \$71) + Grade 4 seat fabric (add \$69) = Total \$2288 List
 HFLRC1DF base price (\$2148) + Grade 5 back fabric (add \$249) + Grade 3 seat fabric (add \$50) = Total \$2447 List

HON Recommendation: HFLSC1DF.TS.PNS__PNS__PR8 - List Price \$2167

HOW TO SPECIFY

| | | | | |
|---|--|--|--|---|
| <p>Select Model Number</p> <p>HFLSC1DF</p> | <p>Select Leg Option</p> <p>L Standard Leg TS Tapered Square TR Tapered Round H Hard Casters</p> <p>TS</p> | <p>Select Back Fabric</p> <p>See page 287</p> <p>PNS004</p> | <p>Select Seat Fabric</p> <p>See page 287</p> <p>PNS007</p> | <p>Select Leg Color</p> <p>PR8 Textured Silver P7A Textured Charcoal</p> <p><i>Specify for Standard, Tapered Round and Tapered Square legs only</i></p> <p>T Black Hard Caster <i>Specify for Hard Caster option only</i></p> <p>PR8</p> |
|---|--|--|--|---|

FLOCK® Multi-Fabric Collaborative

GSA SIN 33721



Icon Legend on page 17

HFLMC1DF

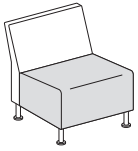

MODULAR CHAIR

Multi-Fabric

DIMENSIONS

| | | | |
|--------------|-----|-----------------------|--------------|
| Depth: | 28½ | Seat to Floor Height: | 17 |
| Width: | 25 | Usable Seat Depth: | 20½ |
| Height: | 28 | Ship Weight: | 52 |
| Seat Depth: | 20½ | Cube: | 24.0 |
| Seat Width: | 25 | COM: | See page 305 |
| Back Width: | 25 | Weight Rating: | 300 lbs. |
| Back Height: | 18½ | | |

FABRIC PRICE CODES

| | | |
|-----------|--------------------------------|--------------|
| 1 | \$1533 | |
| | <i>Add to Base Price Above</i> | |
| | Back | Seat |
| 2 | \$36 | \$36 |
| 3 | \$72 | \$72 |
| 4 | \$99 | \$99 |
| 5 | \$126 | \$126 |
| 6 | \$153 | \$153 |
| 7 | \$180 | \$180 |
| 8 | \$207 | \$207 |
| 9 | \$234 | \$234 |
| 10 | \$261 | \$261 |
| 11 | \$288 | \$288 |
| 12 | \$315 | \$315 |
| L | \$300 | \$300 |

HFLML1DF

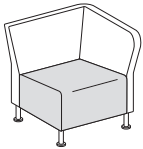

MODULAR LEFT END

Multi-Fabric

DIMENSIONS

| | | | |
|--------------|-----|-----------------------|--------------|
| Depth: | 28½ | Seat to Floor Height: | 17 |
| Width: | 28½ | Usable Seat Depth: | 20½ |
| Height: | 28 | Ship Weight: | 72 |
| Seat Depth: | 20½ | Cube: | 24.0 |
| Seat Width: | 22¼ | COM: | See page 305 |
| Back Width: | 22¼ | Weight Rating: | 300 lbs. |
| Back Height: | 18½ | | |

FABRIC PRICE CODES

| | | |
|-----------|--------------------------------|--------------|
| 1 | \$1792 | |
| | <i>Add to Base Price Above</i> | |
| | Back | Seat |
| 2 | \$71 | \$25 |
| 3 | \$142 | \$50 |
| 4 | \$195 | \$69 |
| 5 | \$249 | \$87 |
| 6 | \$302 | \$106 |
| 7 | \$355 | \$125 |
| 8 | \$408 | \$144 |
| 9 | \$462 | \$162 |
| 10 | \$515 | \$181 |
| 11 | \$568 | \$200 |
| 12 | \$622 | \$218 |
| L | \$592 | \$208 |

HON Recommendation: HFLMC1DF.TS.PNS__PNS__PR8 - List Price \$1605

SEATING

HOW TO SPECIFY

| | | | | |
|-----------------------------------|--|--|--|--|
| <p>Select Model Number</p> | <p>Select Leg Option</p> <p>L Standard Leg TS Tapered Square TR Tapered Round H Hard Casters</p> | <p>Select Back Fabric</p> <p>See page 287</p> | <p>Select Seat Fabric</p> <p>See page 287</p> | <p>Select Leg Color</p> <p>PR8 Textured Silver P7A Textured Charcoal</p> <p><i>Specify for Standard, Tapered Round and Tapered Square legs only</i></p> <p>T Black Hard Caster <i>Specify for Hard Caster option only</i></p> |
| HFLMC1DF | TS | PNS004 | PNS007 | PR8 |



FLOCK® Multi-Fabric Collaborative

HFLMR1DF

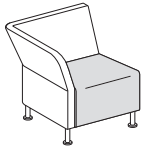

MODULAR RIGHT END

Multi-Fabric

DIMENSIONS

| | | | |
|--------------|-----|-----------------------|--------------|
| Depth: | 28½ | Seat to Floor Height: | 17 |
| Width: | 28½ | Usable Seat Depth: | 20½ |
| Height: | 28 | Ship Weight: | 72.0 |
| Seat Depth: | 20½ | Cube: | 24.0 |
| Seat Width: | 22¼ | COM: | See page 305 |
| Back Width: | 22¼ | Weight Rating: | 300 lbs. |
| Back Height: | 18½ | | |

FABRIC PRICE CODES

| | | |
|--------------------------------|---------------|--------------|
| 1 | \$1792 | |
| <i>Add to Base Price Above</i> | | |
| | Back | Seat |
| 2 | \$71 | \$25 |
| 3 | \$142 | \$50 |
| 4 | \$195 | \$69 |
| 5 | \$249 | \$87 |
| 6 | \$302 | \$106 |
| 7 | \$355 | \$125 |
| 8 | \$408 | \$144 |
| 9 | \$462 | \$162 |
| 10 | \$515 | \$181 |
| 11 | \$568 | \$200 |
| 12 | \$622 | \$218 |
| L | \$592 | \$208 |

HON Recommendation: HFLMR1DF.TS.PNS__PNS__.PR8 - List Price \$1888

HOW TO SPECIFY

| | | | | |
|---|--|--|--|---|
| <p>Select Model Number</p> <p>HFLMR1DF</p> | <p>Select Leg Option</p> <p>L Standard Leg TS Tapered Square TR Tapered Round H Hard Casters</p> <p>TS</p> | <p>Select Back Fabric</p> <p>See page 287</p> <p>PNS004</p> | <p>Select Seat Fabric</p> <p>See page 287</p> <p>PNS007</p> | <p>Select Leg Color</p> <p>PR8 Textured Silver P7A Textured Charcoal</p> <p><i>Specify for Standard, Tapered Round and Tapered Square legs only</i></p> <p>T Black Hard Caster</p> <p><i>Specify for Hard Caster option only</i></p> <p>PR8</p> |
|---|--|--|--|---|

SEATING

FLOCK® Multi-Fabric Collaborative

GSA SIN 33721



Icon Legend on page 17

HFLCC1DF

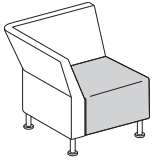

TRUE CORNER CHAIR

Multi-Fabric

DIMENSIONS

| | | | |
|--------------|-----|-----------------------|--------------|
| Depth: | 28½ | Seat to Floor Height: | 17 |
| Width: | 28½ | Usable Seat Depth: | 21 |
| Height: | 28 | Ship Weight: | 60 |
| Seat Depth: | 20½ | Cube: | 21.9 |
| Seat Width: | 20½ | COM: | See page 305 |
| Back Width: | 22¼ | Weight Rating: | 300 lbs. |
| Back Height: | 18½ | | |

FABRIC PRICE CODES

| | | |
|-----------|--------------------------------|--------------|
| 1 | \$1783 | |
| | <i>Add to Base Price Above</i> | |
| | Back | Seat |
| 2 | \$48 | \$48 |
| 3 | \$96 | \$96 |
| 4 | \$144 | \$144 |
| 5 | \$206 | \$206 |
| 6 | \$268 | \$268 |
| 7 | \$330 | \$330 |
| 8 | \$392 | \$392 |
| 9 | \$454 | \$454 |
| 10 | \$516 | \$516 |
| 11 | \$578 | \$578 |
| 12 | \$640 | \$640 |
| L | \$400 | \$400 |

! Leg options – Standard Leg (L), Tapered Square (TS) and Tapered Round (TR) are available in Textured Silver (PR8) and Textured Charcoal (P7A) only. Hard Casters (H) are available on Black (T) only.

HFLWI45DF

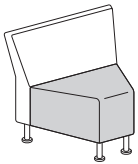

INSIDE WEDGE

Multi-Fabric

DIMENSIONS

| | | | |
|--------------|-----|-----------------------|--------------|
| Depth: | 26¼ | Seat to Floor Height: | 17 |
| Width: | 31½ | Usable Seat Depth: | 19 |
| Height: | 28 | Ship Weight: | 45 |
| Seat Depth: | 19½ | Cube: | 21.9 |
| Seat Width: | 25¾ | COM: | See page 305 |
| Back Width: | 31½ | Weight Rating: | 300 lbs. |
| Back Height: | 18½ | | |

FABRIC PRICE CODES

| | | |
|-----------|--------------------------------|--------------|
| 1 | \$1783 | |
| | <i>Add to Base Price Above</i> | |
| | Back | Seat |
| 2 | \$48 | \$48 |
| 3 | \$96 | \$96 |
| 4 | \$144 | \$144 |
| 5 | \$206 | \$206 |
| 6 | \$268 | \$268 |
| 7 | \$330 | \$330 |
| 8 | \$392 | \$392 |
| 9 | \$454 | \$454 |
| 10 | \$516 | \$516 |
| 11 | \$578 | \$578 |
| 12 | \$640 | \$640 |
| L | \$400 | \$400 |

! Leg options – Standard Leg (L), Tapered Square (TS) and Tapered Round (TR) are available in Textured Silver (PR8) and Textured Charcoal (P7A) only. Hard Casters (H) are available on Black (T) only.

HFLWO45DF

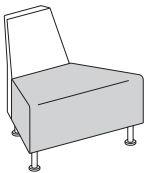

OUTSIDE WEDGE

Multi-Fabric

DIMENSIONS

| | | | |
|--------------|-----|-----------------------|--------------|
| Depth: | 26½ | Seat to Floor Height: | 17 |
| Width: | 32 | Usable Seat Depth: | 19 |
| Height: | 28 | Ship Weight: | 35 |
| Seat Depth: | 19½ | Cube: | 21.9 |
| Seat Width: | 32 | COM: | See page 305 |
| Back Width: | 16¼ | Weight Rating: | 300 lbs. |
| Back Height: | 18½ | | |

FABRIC PRICE CODES

| | | |
|-----------|--------------------------------|--------------|
| 1 | \$1783 | |
| | <i>Add to Base Price Above</i> | |
| | Back | Seat |
| 2 | \$48 | \$48 |
| 3 | \$96 | \$96 |
| 4 | \$144 | \$144 |
| 5 | \$206 | \$206 |
| 6 | \$268 | \$268 |
| 7 | \$330 | \$330 |
| 8 | \$392 | \$392 |
| 9 | \$454 | \$454 |
| 10 | \$516 | \$516 |
| 11 | \$578 | \$578 |
| 12 | \$640 | \$640 |
| L | \$400 | \$400 |

! Leg options – Standard Leg (L), Tapered Square (TS) and Tapered Round (TR) are available in Textured Silver (PR8) and Textured Charcoal (P7A) only. Hard Casters (H) are available on Black (T) only.

HOW TO SPECIFY **HON Recommendation: HFLCC1DF.TS.PNS__PNS__PR8 - List Price \$1879**

| | | | | |
|--|---|---|---|---|
| Select Model Number HFLCC1DF | Select Leg Option L Standard Leg TS Tapered Square TR Tapered Round H Hard Casters | Select Back Fabric See page 287 | Select Seat Fabric See page 287 | Select Leg Color PR8 Textured Silver P7A Textured Charcoal <i>Specify for Standard, Tapered Round and Tapered Square legs only</i> T Black Hard Caster <i>Specify for Hard Caster option only</i> |
| HFLCC1DF | TS | PNS004 | PNS007 | PR8 |



HFLSC1SDF



X-Base

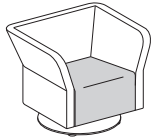

Disc Base

SQUARE LOUNGE CHAIR W/ SWIVEL BASE

Multi-Fabric

DIMENSIONS

| | | | |
|--------------|----------------------------------|---------------------------|--------------------------------|
| Depth: | 28 ⁹ / ₁₆ | Arm Width: | 27 ¹ / ₂ |
| Width: | 34 ³ / ₃₂ | Seat to Floor Height: | 17 |
| Height: | 28 | Usable Seat Depth: | 20 ¹ / ₂ |
| Seat Depth: | 20 ¹⁷ / ₃₂ | Ship Weight (X-base): | 116 |
| Seat Width: | 21 ¹ / ₂ | Ship Weight (Round base): | 148 |
| Back Width: | 21 ¹ / ₂ | Cube: | 21.9 |
| Back Height: | 18 ¹ / ₂ | COM: | See page 305 |
| | | Weight Rating: | 300 lbs. |

FABRIC PRICE CODES

| | | |
|--------------------------------|---------------|--------------|
| 1 | \$2660 | |
| <i>Add to Base Price Above</i> | | |
| | Back | Seat |
| 2 | \$80 | \$28 |
| 3 | \$160 | \$56 |
| 4 | \$220 | \$77 |
| 5 | \$280 | \$98 |
| 6 | \$340 | \$119 |
| 7 | \$400 | \$140 |
| 8 | \$460 | \$161 |
| 9 | \$519 | \$183 |
| 10 | \$579 | \$204 |
| 11 | \$639 | \$225 |
| 12 | \$699 | \$246 |
| L | \$666 | \$234 |

HFLRC1SDF



X-Base

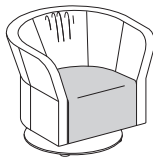

Disc Base

ROUND LOUNGE CHAIR W/ SWIVEL BASE

Multi-Fabric

DIMENSIONS

| | | | |
|--------------|---------------------------------|---------------------------|--------------------------------|
| Depth: | 29 ¹ / ₁₆ | Arm Width: | 27 ¹ / ₂ |
| Width: | 33 ³ / ₃₂ | Seat to Floor Height: | 17 |
| Height: | 28 | Usable Seat Depth: | 20 ¹ / ₂ |
| Seat Depth: | 20 ¹ / ₂ | Ship Weight (X-base): | 94 |
| Seat Width: | 20 ¹ / ₂ | Ship Weight (Round base): | 126 |
| Back Width: | 20 ¹ / ₂ | Cube: | 21.9 |
| Back Height: | 18 ¹ / ₂ | Weight Rating: | 300 lbs. |

FABRIC PRICE CODES

| | | |
|--------------------------------|---------------|--------------|
| 1 | \$2754 | |
| <i>Add to Base Price Above</i> | | |
| | Back | Seat |
| 2 | \$71 | \$25 |
| 3 | \$142 | \$50 |
| 4 | \$195 | \$69 |
| 5 | \$249 | \$87 |
| 6 | \$302 | \$106 |
| 7 | \$355 | \$125 |
| 8 | \$408 | \$144 |
| 9 | \$462 | \$162 |
| 10 | \$515 | \$181 |
| 11 | \$568 | \$200 |
| 12 | \$622 | \$218 |
| L | \$592 | \$208 |

NOTES: Due to the inherent design of the Round Lounge chair, material gathers will be present in the back.
 ! Round Lounge model HFLRC1SDF is offered in select fabrics; for availability, please see the Fabric Matrix on page 287. Also approved in limited Partnership Fabrics.

For multi-fabric models, start with the base price, then add the additional amount for the back and seat from the corresponding matrix to determine the final list price. Choose any combination of fabric grades for the back and seat.

Example: HFLRC1SDF base price (\$2754) + Grade 2 back fabric (add \$71) + Grade 4 seat fabric (add \$69) = Total \$2894 List

HFLMC1SDF



X-Base

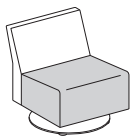

Disc Base

MODULAR CHAIR W/ SWIVEL BASE

Multi-Fabric

DIMENSIONS

| | | | |
|--------------|--------------------------------|---------------------------|--------------------------------|
| Depth: | 28 ¹ / ₂ | Seat to Floor Height: | 17 |
| Width: | 25 | Usable Seat Depth: | 20 ¹ / ₂ |
| Height: | 28 ¹ / ₂ | Ship Weight (X-base): | 91 |
| Seat Depth: | 20 ¹ / ₂ | Ship Weight (Round base): | 123 |
| Seat Width: | 25 | Cube: | 21.9 |
| Back Width: | 25 | COM: | See page 305 |
| Back Height: | 18 ¹ / ₂ | Weight Rating: | 300 lbs. |

FABRIC PRICE CODES

| | | |
|--------------------------------|---------------|--------------|
| 1 | \$1995 | |
| <i>Add to Base Price Above</i> | | |
| | Back | Seat |
| 2 | \$36 | \$36 |
| 3 | \$72 | \$72 |
| 4 | \$99 | \$99 |
| 5 | \$126 | \$126 |
| 6 | \$153 | \$153 |
| 7 | \$180 | \$180 |
| 8 | \$207 | \$207 |
| 9 | \$234 | \$234 |
| 10 | \$261 | \$261 |
| 11 | \$288 | \$288 |
| 12 | \$315 | \$315 |
| L | \$300 | \$300 |

HOW TO SPECIFY

HON Recommendation: HFLMC1SDF.X.PNS__PNS__PR8 - List Price \$2067

| | | | | |
|--|---|---|---|---|
| <p>Select Model Number</p> <p>H F L M C 1 S D F</p> | <p>Select Swivel Option</p> <p>X X Base D Disc Base</p> <p>X</p> | <p>Select Back Fabric</p> <p>See page 287</p> <p>P N S 0 0 4</p> | <p>Select Seat Fabric</p> <p>See page 287</p> <p>P N S 0 0 7</p> | <p>Select Base Color</p> <p>PR8 Textured Silver P7A Textured Charcoal</p> <p>PR8</p> |
|--|---|---|---|---|

FLOCK® Base Frames and Legs

OPEN MARKET



Icon Legend on page 17

| | DESCRIPTION | MODEL | SHIP WEIGHT | CUBE | LIST PRICE |
|--|-----------------------|-------|-------------|------|------------|
|  | Two-Seat Base Frame | HFLB2 | 25 | 5.9 | \$447 |
| | Three-Seat Base Frame | HFLB3 | 33 | 7.8 | \$558 |

HOW TO SPECIFY

| | |
|--|--|
| <p>Select Model Number</p> <p>H F L B 2 .</p> | <p>Select Leg Option</p> <p>RS Round Straight Leg TS Tapered Square Leg (+ \$75)</p> <p>Select Leg Color</p> <p>PR8 Textured Silver P7A Textured Charcoal</p> <p>R S P R 8</p> |
|--|--|

| | DESCRIPTION | MODEL | SHIP WEIGHT | CUBE | LIST PRICE |
|--|----------------------------------|--------|-------------|------|------------|
|  | Tapered Square Leg — Shroud Pack | HTSSRD | 2 | 1.0 | \$85 |

HOW TO SPECIFY

| | |
|--|--|
| <p>Select Model Number</p> <p>H T S S R D .</p> | <p>Select Leg Color</p> <p>PR8 Textured Silver P7A Textured Charcoal</p> <p>P R 8</p> |
|--|--|

SEATING

MODEL OPTIONS

HFSS7



Stool

HFCG6
HFCG6DF - Multi-Fabric



Guest Chair
Casual

HFCL2
HFCL2DF - Multi-Fabric



Wide Lounge Chair
With 4-Star Return-to-Center

HFLSC2
HFLSC2DF - Multi-Fabric



Square Chair
With 4-Star Return-to-Center

HFSS74L
HFSS74LDF - Multi-Fabric



Stool
4-Leg

SHELL COLOR

| CODE | DESCRIPTION | PRICE |
|-----------|-------------|-------------|
| LA | Lava | +\$0 |
| ON | Onyx | +\$0 |
| PT | Platinum | +\$0 |
| SD | Shadow | +\$0 |

**Available for model HFSS7 only*

FRAME

| CODE | DESCRIPTION | PRICE |
|--|--------------------------|-------------|
| 4S | 4-Star Return-to-Center* | +\$0 |
| <i>*Available for models HFCL2 and HFLSC2 only</i> | | |
| <i>Available in the following finishes:</i> | | |
| PR8 | Textured Silver | |
| P7A | Textured Charcoal | |

FLOCK® Fabric Options

HON BRANDED FABRICS

| GRADE 1 | GRADE 2 | GRADE 3 | GRADE L |
|------------|-----------------|-----------|-----------------|
| Apex | Appoint Seating | In Season | Denver Leather* |
| Attire | Blume | Moxie | |
| Centurion | Clyde | Parker | |
| Compass | Dotty | Purl | |
| Contourett | Rush | Quill | |
| Dapper | Seed | | |
| Ensemble | Spin Seating | | |
| Hamilton | Whisper Vinyl | | |
| Inertia | | | |
| Optic | | | |
| Pebble | | | |

For a complete list of fabrics, including partnership fabrics, go to hon.com/fabricsandfinishes.

Flock® chair models HFLRC1 and HFLRC1DF have fabric limitations, please see the Flock® seating pages 288-297 and 301 for details.

Reference Fabric Color Combinations on pages 18-22 for color codes and legend on page 19 for lead times.

*Denver Leather (SS) may not be available on every model within a specific series, please refer to the model's page for details.

FLOCK® SQUARE CHAIR HFLSC2/DF HON BRANDED FABRICS

| GRADE 1 | GRADE 2 | GRADE 3 | GRADE L |
|------------|-----------------|-----------|------------------|
| Apex | Appoint Seating | In Season | Denver Leather** |
| Centurion | Blume | Moxie | |
| Compass | Clyde | Parker | |
| Contourett | Rush | Purl | |
| Dapper | Seed* | Quill | |
| Ensemble | Spin Seating* | | |
| Hamilton | Whisper Vinyl | | |
| Inertia | | | |
| Optic* | | | |
| Pebble | | | |

For a complete list of fabrics, including partnership fabrics, go to hon.com/fabricsandfinishes.

Flock® chair model HFLSC2/DF has fabric limitations, please see the Flock® seating pages 302-304 for details.

*Available on seat only.

**Denver Leather (SS) may not be available on every model within a specific series, please refer to the model's page for details.

Reference Fabric Color Combinations on pages 18-22 for color codes and legend on page 19 for lead times.



HFSS7

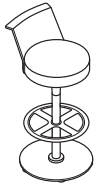

STOOL

DIMENSIONS

| | | | |
|--------------|--------------------------------|-----------------------|--------------------------------|
| Depth: | 18 | Seat to Floor Height: | 31 |
| Width: | 18 | Usable Seat Depth: | 15 ³ / ₄ |
| Height: | 39 ¹ / ₈ | Ship Weight: | 57 |
| Seat Depth: | 15 ³ / ₄ | Cube: | 11.0 |
| Seat Width: | 15 ³ / ₄ | Weight Rating: | 300 lbs. |
| Back Width: | 15 ³ / ₄ | | |
| Back Height: | 8 | | |

FABRIC PRICE CODES

| | | | |
|---|--------|----|--------|
| 1 | \$900 | 8 | \$1107 |
| 2 | \$936 | 9 | \$1134 |
| 3 | \$972 | 10 | \$1161 |
| 4 | \$999 | 11 | \$1188 |
| 5 | \$1026 | 12 | \$1215 |
| 6 | \$1053 | L | — |
| 7 | \$1080 | | |

! Customer's Own Material (COM) is not available on Flock[®] models HFLRC1 or HFSS7.

HON Recommendation: HFSS7.PT.PNS__PR8 - List Price \$936

HOW TO SPECIFY

| | | | |
|---|---|--|--|
| Select Model Number HFSS7 | Select Shell Color LA Lava ON Onyx PT Platinum SD Shadow PT | Select Fabric See page 300 PNS007 | Select Frame PR8 Textured Silver P7A Textured Charcoal PR8 |
|---|---|--|--|

HFCG6



GUEST CHAIR

Casual

DIMENSIONS

| | | | |
|--------------|---------------------------------|-----------------------|--------------------------------|
| Depth: | 23 ⁵ / ₁₆ | Seat to Floor Height: | 18 ¹ / ₄ |
| Width: | 19 | Usable Seat Depth: | 16 ⁷ / ₈ |
| Height: | 32 ¹ / ₂ | Ship Weight: | 24 |
| Seat Depth: | 16 ⁷ / ₈ | Cube: | 10.4 |
| Seat Width: | 19 | COM: | 1.8 |
| Back Width: | 19 | Weight Rating: | 300 lbs. |
| Back Height: | 14 ¹ / ₄ | | |

FABRIC PRICE CODES

| | | | |
|---|-------|----|--------|
| 1 | \$668 | 8 | \$944 |
| 2 | \$716 | 9 | \$980 |
| 3 | \$764 | 10 | \$1016 |
| 4 | \$800 | 11 | \$1052 |
| 5 | \$836 | 12 | \$1088 |
| 6 | \$872 | L | \$1068 |
| 7 | \$908 | | |

HFSS74L



STOOL

4-Leg

DIMENSIONS

| | | | |
|--------------|--------------------------------|-----------------------|--------------------------------|
| Depth: | 21 ⁵ / ₈ | Seat to Floor Height: | 30 |
| Width: | 18 | Usable Seat Depth: | 15 ⁷ / ₈ |
| Height: | 40 ⁷ / ₈ | Ship Weight: | 35 |
| Seat Depth: | 15 ⁷ / ₈ | Cube: | 21.8 |
| Seat Width: | 18 | COM: | 1.9 |
| Back Width: | 18 | Weight Rating: | 300 lbs. |
| Back Height: | 10 ⁷ / ₈ | | |

FABRIC PRICE CODES

| | | | |
|---|--------|----|--------|
| 1 | \$841 | 8 | \$1117 |
| 2 | \$889 | 9 | \$1153 |
| 3 | \$937 | 10 | \$1189 |
| 4 | \$973 | 11 | \$1225 |
| 5 | \$1009 | 12 | \$1261 |
| 6 | \$1045 | L | \$1241 |
| 7 | \$1081 | | |

HON Recommendation: HFSS74L.PNS__PR8 - List Price \$889

HOW TO SPECIFY

| | | |
|---|--|---|
| Select Model Number HFSS74L | Select Fabric See page 300 PNS007 | Select Frame PR8 Textured Silver PR8 |
|---|--|---|



HFCL2



WIDE LOUNGE CHAIR

with 4-Star Return-to-Center

DIMENSIONS

| | | | |
|--------------|-----|-----------------------|----------|
| Depth: | 27½ | Seat to Floor Height: | 17 |
| Width: | 26¾ | Usable Seat Depth: | 19 |
| Height: | 32¼ | Ship Weight: | 53 |
| Seat Width: | 26 | Cube: | 25.1 |
| Back Width: | 25½ | COM: | 2.5 |
| Back Height: | 19½ | Weight Rating: | 300 lbs. |

FABRIC PRICE CODES

| | | | |
|---|--------|----|--------|
| 1 | \$1138 | 8 | \$1552 |
| 2 | \$1210 | 9 | \$1606 |
| 3 | \$1282 | 10 | \$1660 |
| 4 | \$1336 | 11 | \$1714 |
| 5 | \$1390 | 12 | \$1768 |
| 6 | \$1444 | L | \$1738 |
| 7 | \$1498 | | |

HFLSC2



SQUARE CHAIR

with 4-Star Return-to-Center

DIMENSIONS

| | | | |
|--------------|-----|-----------------------|----------|
| Depth: | 26½ | Seat to Floor Height: | 18 |
| Width: | 27½ | Usable Seat Depth: | 18¾ |
| Height: | 32¼ | Ship Weight: | 46 |
| Seat Width: | 17½ | Cube: | 25.1 |
| Back Width: | 16 | COM: | See note |
| Back Height: | 17¾ | Weight Rating: | 300 lbs. |

FABRIC PRICE CODES

| | | | |
|---|--------|----|--------|
| 1 | \$1640 | 8 | \$2054 |
| 2 | \$1712 | 9 | \$2108 |
| 3 | \$1784 | 10 | \$2162 |
| 4 | \$1838 | 11 | \$2216 |
| 5 | \$1892 | 12 | \$2270 |
| 6 | \$1946 | L | \$2240 |
| 7 | \$2000 | | |

NOTES: Due to fabric limitations, COM is unavailable for back upholstery. See HFLSC2DF for COM available on the seat only.

HON Recommendation: HFLSC2.PNS__4SPR8 - List Price \$1640

HOW TO SPECIFY

Select Model Number

H F L S C 2 .

Select Fabric

See page 300

P N S 0 0 7 .

Select Base Option

4S 4-Star Return-to-Center

Select Base Color

PR8 Textured Silver
P7A Textured Charcoal

4 S P R 8



HFSG6DF



CASUAL GUEST CHAIR

Multi-Fabric

DIMENSIONS

| | | | |
|--------------|---------------------------------|-----------------------|--------------------------------|
| Depth: | 23 ⁵ / ₁₆ | Seat to Floor Height: | 18 ¹ / ₄ |
| Width: | 19 | Usable Seat Depth: | 16 ⁷ / ₈ |
| Height: | 32 ¹ / ₂ | Ship Weight: | 24 |
| Seat Depth: | 16 ⁷ / ₈ | Cube: | 10.4 |
| Seat Width: | 19 | COM: | See page 305 |
| Back Width: | 19 | Weight Rating: | 300 lbs. |
| Back Height: | 14 ¹ / ₄ | | |

FABRIC PRICE CODES

| | | |
|--------------------------------|--------------|--------------|
| 1 | \$757 | |
| <i>Add to Base Price Above</i> | | |
| | Back | Seat |
| 2 | \$24 | \$24 |
| 3 | \$48 | \$48 |
| 4 | \$66 | \$66 |
| 5 | \$84 | \$84 |
| 6 | \$102 | \$102 |
| 7 | \$120 | \$120 |
| 8 | \$138 | \$138 |
| 9 | \$156 | \$156 |
| 10 | \$174 | \$174 |
| 11 | \$192 | \$192 |
| 12 | \$210 | \$210 |
| L | \$200 | \$200 |

HFSS74LDF



4-LEG STOOL

Multi-Fabric

DIMENSIONS

| | | | |
|--------------|--------------------------------|-----------------------|--------------------------------|
| Depth: | 21 ¹ / ₈ | Seat to Floor Height: | 30 |
| Width: | 18 | Usable Seat Depth: | 15 ¹ / ₈ |
| Height: | 40 ⁷ / ₈ | Ship Weight: | 35 |
| Seat Depth: | 15 ¹ / ₈ | Cube: | 21.8 |
| Seat Width: | 18 | COM: | See page 305 |
| Back Width: | 18 | Weight Rating: | 300 lbs. |
| Back Height: | 10 ⁷ / ₈ | | |

FABRIC PRICE CODES

| | | |
|--------------------------------|--------------|--------------|
| 1 | \$932 | |
| <i>Add to Base Price Above</i> | | |
| | Back | Seat |
| 2 | \$24 | \$24 |
| 3 | \$48 | \$48 |
| 4 | \$66 | \$66 |
| 5 | \$84 | \$84 |
| 6 | \$102 | \$102 |
| 7 | \$120 | \$120 |
| 8 | \$138 | \$138 |
| 9 | \$156 | \$156 |
| 10 | \$174 | \$174 |
| 11 | \$192 | \$192 |
| 12 | \$210 | \$210 |
| L | \$200 | \$200 |

HON Recommendation: HFSS74LDF.PNS___.PNS___.PR8 - List Price \$980

HOW TO SPECIFY

| | | | |
|--|--|--|---|
| <p>Select Model Number</p> <p>HFSS74LDF</p> | <p>Select Back Fabric</p> <p>See page 300</p> <p>PNS004</p> | <p>Select Seat Fabric</p> <p>See page 300</p> <p>PNS007</p> | <p>Select Frame</p> <p>PR8 Textured Silver (only)</p> <p>PR8</p> |
|--|--|--|---|

FLOCK® Multi-Fabric Collaborative

OPEN MARKET



Icon Legend on page 17

HFCL2DF



WIDE LOUNGE CHAIR

with 4-Star Return-to-Center

DIMENSIONS

| | | | |
|--------------|-----|-----------------------|--------------|
| Depth: | 27½ | Seat to Floor Height: | 17 |
| Width: | 26¾ | Usable Seat Depth: | 19 |
| Height: | 32¼ | Ship Weight: | 53 |
| Seat Width: | 26 | Cube: | 25.1 |
| Back Width: | 25½ | COM: | See page 305 |
| Back Height: | 19½ | Weight Rating: | 300 lbs. |

FABRIC PRICE CODES

| | | |
|--------------------------------|---------------|--------------|
| 1 | \$1218 | |
| <i>Add to Base Price Above</i> | | |
| | Back | Seat |
| 2 | \$36 | \$36 |
| 3 | \$108 | \$108 |
| 4 | \$162 | \$162 |
| 5 | \$216 | \$216 |
| 6 | \$270 | \$270 |
| 7 | \$324 | \$324 |
| 8 | \$378 | \$378 |
| 9 | \$432 | \$432 |
| 10 | \$486 | \$486 |
| 11 | \$540 | \$540 |
| 12 | \$594 | \$594 |
| L | \$300 | \$300 |

HFLSC2DF



SQUARE CHAIR

with 4-Star Return-to-Center

DIMENSIONS

| | | | |
|--------------|-----|-----------------------|----------|
| Depth: | 26½ | Seat to Floor Height: | 18 |
| Width: | 27½ | Usable Seat Depth: | 18¾ |
| Height: | 32¼ | Ship Weight: | 46 |
| Seat Width: | 17½ | Cube: | 25.1 |
| Back Width: | 16 | COM: | See note |
| Back Height: | 17¾ | Weight Rating: | 300 lbs. |

FABRIC PRICE CODES

| | | |
|--------------------------------|---------------|--------------|
| 1 | \$1723 | |
| <i>Add to Base Price Above</i> | | |
| | Back | Seat |
| 2 | \$48 | \$24 |
| 3 | \$120 | \$96 |
| 4 | \$174 | \$150 |
| 5 | \$228 | \$204 |
| 6 | \$282 | \$258 |
| 7 | \$336 | \$312 |
| 8 | \$390 | \$366 |
| 9 | \$444 | \$420 |
| 10 | \$498 | \$474 |
| 11 | \$552 | \$528 |
| 12 | \$606 | \$582 |
| L | \$400 | \$200 |

NOTES: Due to fabric limitations, COM is unavailable for back upholstery. See HFLSC2DF for COM available on the seat only.

HON Recommendation: HFLSC2DF.PURL__PURL__4SPR8 - List Price \$1939

SEATING

HOW TO SPECIFY

| | | | |
|--|---|---|--|
| <p>Select Model Number</p> <p>H F L S C 2 D F .</p> | <p>Select Back Fabric</p> <p>See page 300</p> <p>P U R L 1 2 .</p> | <p>Select Seat Fabric</p> <p>See page 300</p> <p>P U R L 1 2 .</p> | <p>Select Base Option</p> <p>4S 4-Star Return-to-Center</p> <p>Select Base Color</p> <p>PR8 Textured Silver P7A Textured Charcoal</p> <p>4 S P R 8</p> |
|--|---|---|--|

MODEL OPTIONS

HFLC01
HFLC01DF - Multi-Fabric

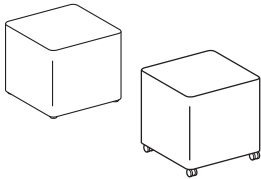

Mini Cube

HFLY01
HFLY01DF - Multi-Fabric

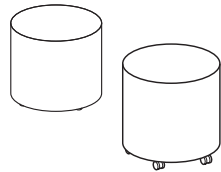

Mini Cylinder

CASTER/ GLIDES

| CODE | DESCRIPTION | PRICE |
|--|------------------------------|--------------|
| A | Active Base* | +\$75 |
| <i>*Available on models HFLY01 and HFLY01DF only</i> | | |
| H | Hard Caster | +\$0 |
| HG | Hidden Glide | +\$0 |
| LPR8 | Textured Silver Disc Glide | +\$45 |
| LP7A | Textured Charcoal Disc Glide | +\$45 |

MULTI-FABRIC COM YARDAGE

Due to fabric pattern nesting and potential reduction of fabric yield, some multi-fabric models may require more total yardage than standard models.

| MODEL | BACK COM | SEAT COM |
|-----------|------------|-------------|
| HFLMC1DF | 1.6 | 1.5 |
| HFLML1DF | 2.9 | 1.4 |
| HFLMR1DF | 2.9 | 1.4 |
| HFCG6DF | 1.8 | 1.9 |
| HFSS74LDF | 1.4 | 1.9 |
| HFLWI45DF | 2.3 | 1.4 |
| HFLWO45DF | 1.0 | 1.4 |
| HFLCC1DF | 2.3 | 1.4 |
| HFLSC1SDF | 3.6 | 1.4 |
| HFLMC1SDF | 1.6 | 1.5 |
| HFCL2DF | N/A | 2.0 |
| HFLSC2DF | N/A | 3.0 |
| | TOP | SIDE |
| HFLC01DF | 0.7 | 1.2 |
| HFLY01DF | 0.7 | 1.2 |

HON BRANDED FABRICS

GRADE 1

Apex
Attire
Centurion
Compass
Contourett
Dapper
Ensemble
Hamilton
Inertia
Optic
Pebble

GRADE 2

Appoint Seating
Blume
Clyde
Dotty
Rush
Spin Seating
Whisper Vinyl

GRADE 3

In Season
Moxie
Parker
Purl
Quill

GRADE L

Denver Leather

For a complete list of fabrics, including partnership fabrics, go to hon.com/fabricsandfinishes.

Reference Fabric Color Combinations on pages 18-22 for color codes and legend on page 19 for lead times.

FLOCK® Mini Cube and Cylinders

GSA SIN 33721



Icon Legend on page 17

HFLCO1

MINI CUBE

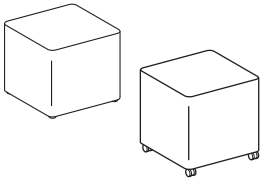

DIMENSIONS

| | | | |
|-------------|-----|-----------------------|----------|
| Depth: | 18½ | Seat to Floor Height: | 17 |
| Width: | 18½ | Usable Seat Depth: | 18½ |
| Height: | 17 | Ship Weight: | 15 |
| Seat Depth: | 18½ | Cube: | 5.0 |
| Seat Width: | 18½ | COM: | 2.0 |
| | | Weight Rating: | 300 lbs. |

FABRIC PRICE CODES

| | | | |
|---|-------|----|-------|
| 1 | \$506 | 8 | \$713 |
| 2 | \$542 | 9 | \$740 |
| 3 | \$578 | 10 | \$767 |
| 4 | \$605 | 11 | \$794 |
| 5 | \$632 | 12 | \$821 |
| 6 | \$659 | L | \$806 |
| 7 | \$686 | | |

HFLY01

MINI CYLINDER

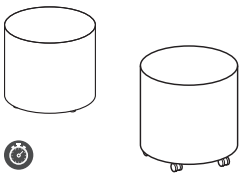

DIMENSIONS

| | | | |
|-------------|-----|-----------------------|----------|
| Depth: | 18½ | Seat to Floor Height: | 17 |
| Width: | 18½ | Usable Seat Depth: | 18½ |
| Height: | 17 | Ship Weight: | 13 |
| Seat Depth: | 18½ | Cube: | 5.0 |
| Seat Width: | 18½ | COM: | 2.0 |
| | | Weight Rating: | 300 lbs. |

FABRIC PRICE CODES

| | | | |
|---|-------|----|-------|
| 1 | \$505 | 8 | \$712 |
| 2 | \$541 | 9 | \$739 |
| 3 | \$577 | 10 | \$766 |
| 4 | \$604 | 11 | \$793 |
| 5 | \$631 | 12 | \$820 |
| 6 | \$658 | L | \$805 |
| 7 | \$685 | | |

HON Recommendation: HFLY01.LPR8.PNS__ - List Price \$586

SEATING

HOW TO SPECIFY

Select Model Number

HFLY01

Select Base

- A** Active Base* (+ \$75)
- *Available on model HFLY01 only*
- H** Caster
- HG** Hidden Glide
- LPR8** Textured Silver Disc Glide (+ \$45)
- LP7A** Textured Charcoal Disc Glide (+ \$45)

LPR8

Select Fabric

See page 305

PNS007

Multi-Fabric Mini Cube and Cylinder

HFLCO1DF

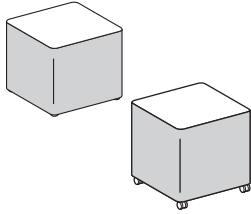

MINI CUBE

Multi-Fabric

DIMENSIONS

| | | | |
|-------------|-----|-----------------------|--------------|
| Depth: | 18½ | Seat to Floor Height: | 17 |
| Width: | 18½ | Usable Seat Depth: | 18½ |
| Height: | 17 | Ship Weight: | 15 |
| Seat Depth: | 18½ | Cube: | 5.0 |
| Seat Width: | 18½ | COM: | See page 305 |
| | | Weight Rating: | 300 lbs. |

FABRIC PRICE CODES

| | | |
|--------------------------------|--------------|--------------|
| 1 | \$593 | |
| <i>Add to Base Price Above</i> | | |
| | Top | Sides |
| 2 | \$11 | \$25 |
| 3 | \$22 | \$50 |
| 4 | \$30 | \$69 |
| 5 | \$38 | \$88 |
| 6 | \$46 | \$107 |
| 7 | \$54 | \$126 |
| 8 | \$62 | \$145 |
| 9 | \$70 | \$164 |
| 10 | \$78 | \$183 |
| 11 | \$86 | \$202 |
| 12 | \$95 | \$221 |
| L | \$90 | \$210 |

HFLY01DF

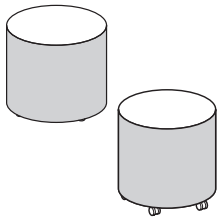

MINI CYLINDER

Multi-Fabric

DIMENSIONS

| | | | |
|-------------|-----|-----------------------|--------------|
| Depth: | 18½ | Seat to Floor Height: | 17 |
| Width: | 18½ | Usable Seat Depth: | 18½ |
| Height: | 17 | Ship Weight: | 13 |
| Seat Depth: | 18½ | Cube: | 5.0 |
| Seat Width: | 18½ | COM: | See page 305 |
| | | Weight Rating: | 300 lbs. |

FABRIC PRICE CODES

| | | |
|--------------------------------|--------------|--------------|
| 1 | \$592 | |
| <i>Add to Base Price Above</i> | | |
| | Top | Sides |
| 2 | \$11 | \$25 |
| 3 | \$22 | \$50 |
| 4 | \$30 | \$69 |
| 5 | \$38 | \$88 |
| 6 | \$46 | \$107 |
| 7 | \$54 | \$126 |
| 8 | \$62 | \$145 |
| 9 | \$70 | \$164 |
| 10 | \$78 | \$183 |
| 11 | \$86 | \$202 |
| 12 | \$95 | \$221 |
| L | \$90 | \$210 |

HON Recommendation: HFLCO1DF.HG.PNS___.PNS__ - List Price \$629

HOW TO SPECIFY

| | | | |
|-----------------------------------|---|---|--|
| <p>Select Model Number</p> | <p>Select Base</p> <p>A Active Base* (+ \$75) *Available on model HFLY01DF only</p> <p>H Caster HG Hidden Glide LPR8 Textured Silver Disc Glide (+ \$45) LP7A Textured Charcoal Disc Glide (+ \$45)</p> | <p>Select Top Fabric</p> <p>See page 305</p> | <p>Select Side Fabric</p> <p>See page 305</p> |
| <p>H F L C O 1 D F .</p> | <p>H G .</p> | <p>P N S 0 0 7 .</p> | <p>P N S 0 0 4</p> |

GATEWAY™

Want to see more? Scan here
to check out hon.com.



Gateway™ Chairs shown
with Huddle Tables.

GATEWAY™

So you need a new chair, but it has to look as cool as it is comfortable. We've got you covered. Gateway takes the complexity out of finding the perfect chair by focusing on exactly what you're looking for. Cool, breathable mesh. Personalized seat fabrics. Targeted back support. Just what you need. Nothing you don't. All at a price you'll have to look at twice to make sure it's not a typo.



FEATURES

- Seat has comfortable, waterfall edge.
- Mesh back material flexes for a relaxed fit.
- Adjustable lumbar.
- Adjustable tilt to recline based on body type.
- Three arm options.
- Carton is 2 cubic feet smaller than the industry average.

HON BRANDED FABRICS

GRADE 1

Centurion
Contourett

GRADE 2

Dotty

For a complete list of fabrics, including partnership fabrics, go to hon.com/fabricsandfinishes.

Reference Fabric Color Combinations on pages 18-22 for color codes and legend on page 19 for lead times.

GATEWAY™ Standard Task Chair

OPEN MARKET



Icon Legend on page 17

HGTMM

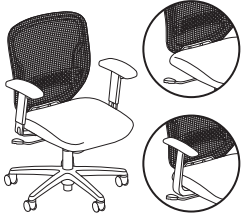

TASK CHAIR

- Mesh Back
- Pneumatic
- Swivel
- Tilt Tension
- Tilt Lock
- Adjustable Lumbar Support

Functions: **A, E, F, K, L, W**
(Function Key on pages 212-213)

NOTES: **HON 5-Year Limited Warranty.**

DIMENSIONS

| | | | |
|--------------|-----|-----------------------|----------|
| Depth: | 25¼ | Seat to Floor Height: | 17-22 |
| Width: | 27 | Usable Seat Depth: | 19 |
| Height: | 38 | Ship Weight: | 35 |
| Seat Depth: | 19 | Cube: | 3.4 |
| Seat Width: | 18½ | Weight Rating: | 250 lbs. |
| Back Width: | 18 | | |
| Back Height: | 18½ | | |

FABRIC PRICE CODES

| | |
|----------|--------------|
| 1 | \$289 |
| 2 | \$301 |

HOW TO SPECIFY

| | | | | | | | | |
|----------------------------|----------------------------|---|----------------------|-------------------------|----------------------|----------------------|--------------------|---------------------|
| Select Model Number | Select Control Type | Select Arm Type | Select Caster | Select Back Type | Select Fabric | Select Lumbar | Select Base | Select Frame |
| | Z1 Swivel-Tilt Control | N Armless F Fixed Arms (+ \$35) H Height-Adjustable Arms (+ \$55) | H Black Hard Caster | M Mesh | See page 309 | AL Adjustable Lumbar | SB Standard Base | T Black |
| HGTMM | Z1 | H | H | M | CU10 | AL | SB | T |



GATEWAY™ Value Task Chair

HGV1MM

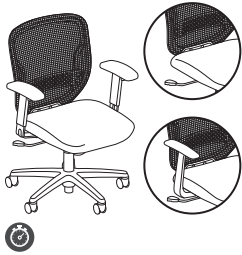

TASK CHAIR VALUE MODEL

Mesh Back

- Pneumatic
- Swivel
- Tilt Tension
- Tilt Lock
- Adjustable Lumbar Support

Functions: **A, E, F, K, L, W**
(Function Key on pages 212-213)

NOTES: **HON 5-Year Limited Warranty.**

DIMENSIONS

| | | | |
|--------------|-----|-----------------------|----------|
| Depth: | 25¼ | Seat to Floor Height: | 17-22 |
| Width: | 27 | Usable Seat Depth: | 19 |
| Height: | 38 | Ship Weight: | 35 |
| Seat Depth: | 19 | Cube: | 3.4 |
| Seat Width: | 18½ | Weight Rating: | 250 lbs. |
| Back Width: | 18 | | |
| Back Height: | 18½ | | |

LIST PRICE

\$258

HOW TO SPECIFY

| Select Model Number | Select Control Type | Select Arm Type | Select Caster | Select Back Type | Select Fabric | Select Lumbar | Select Base | Select Frame |
|-------------------------------|--|----------------------------|---------------|---------------------|-----------------------------|-------------------------|----------------|--------------|
| Z1 Swivel-Tilt Control | N Armless F Fixed Arms (+ \$35) H Height-Adjustable Arms (+ \$55) | H Black Hard Caster | M Mesh | ACCF10 Black | AL Adjustable Lumbar | SB Standard Base | T Black | |
| HGV1MM | Z1 | H | H | M | ACCF10 | AL | SB | T |



Grove® Lounge shown with Flock® Table.

GROVE®

Find a comfy place to put your feet up, huddle up and power up. Grove is the versatile lounge seating designed to help you greet, meet, focus, relax and accomplish more. This change-of-pace collection delivers the comfort people crave, while encouraging focus and interaction throughout the workplace. Grove's attractive design is rivaled only by its flexibility. Models include a single seat, two-seat, three-seat, and two-seat with table — all with three arm style and two leg style options, as well as accessories that support connectivity and collaboration. Grove has the look you're going for, and the comfort and versatility people have been waiting for.



FEATURES

- Each model can be combined to create arrangements suitable for any space.
- Optional integrated worksurfaces create more personal space and provide a convenient workspace.
- Design complements Flock ottomans and tables.
- Integrated power grommets keep laptops and phone powered up anywhere.
- The multi-fabric option coordinates two high-quality HON fabrics for a contemporary look.
- Choose from Single Seat, Two-Seat, Three-Seat Lounge, or Two-Seat with Table options.
- Choose from 3 arm options — Armless (N), Straight Arms (A), or Tapered Arm (B).
- Table available with two grommets and an accessory port option.
- Offers a table between the seats that provides separation and a usable workspace.
- Warranted for users up to 300 lbs.

MODEL OPTIONS

HML1S
HML1SDF - Multi-Fabric

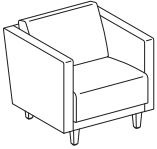

Lounge
Single Seat

HML2S
HML2SDF - Multi-Fabric

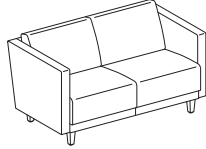

Lounge
Two-Seat

HML3S
HML3SDF - Multi-Fabric

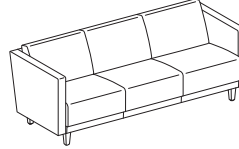

Lounge
Three-Seat

HML2ST
HML2STDF - Multi-Fabric

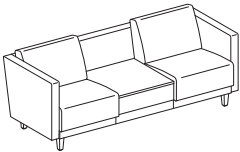

Lounge
Two-Seat with Table

GROVE® Options

ARM STYLE

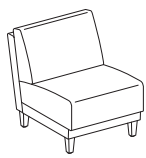

| CODE | DESCRIPTION | PRICE |
|----------|-------------|-------------|
| N | Armless | +\$0 |

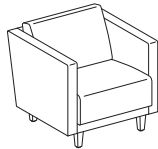

| | | |
|----------|---------------|---------------|
| A | Straight Arms | +\$300 |
|----------|---------------|---------------|

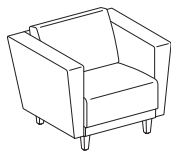

| | | |
|----------|--------------|---------------|
| B | Tapered Arms | +\$350 |
|----------|--------------|---------------|

LEG STYLE



| CODE | DESCRIPTION | PRICE |
|-----------|----------------|-------------|
| TS | Tapered Square | +\$0 |



| | | |
|-----------|---------------|-------------|
| TR | Tapered Round | +\$0 |
|-----------|---------------|-------------|

LEG COLOR

| CODE | DESCRIPTION | PRICE |
|-------------|-------------------|---------------|
| PR8 | Textured Silver | +\$0 |
| P7A | Textured Charcoal | +\$0 |
| H | Bourbon Cherry | +\$100 |
| F | Shaker Cherry | +\$100 |
| N | Mahogany | +\$100 |
| C | Harvest | +\$100 |
| D | Natural Maple | +\$100 |
| LK11 | Kingswood Walnut | +\$100 |
| LSA1 | Sterling Ash | +\$100 |

CUT OUT

| CODE | DESCRIPTION | PRICE |
|-----------|----------------------|--------------|
| N | No Cutout | +\$0 |
| G | Round Grommet Cutout | +\$30 |
| G1 | Pop-Up Port Cutout | +\$40 |

**Specify for models HML2ST and HML2STDF only*

ACCESSORY PORT LOCATION

| CODE | DESCRIPTION | PRICE |
|----------|---------------------------|--------------|
| 0 | No Port | +\$0 |
| 2 | Two Tablet Ports Opposite | +\$20 |

**Specify for models HML2ST and HML2STDF only*

L1 LAMINATE COLOR CODE

| | |
|------------------|-------------|
| Black | P |
| Bourbon Cherry | H |
| Designer White | LDW1 |
| Charcoal | S |
| Cognac | COGN |
| Florence Walnut | LFW1 |
| Harvest | C |
| Kingswood Walnut | LK11 |
| Loft | LOFT |
| Mahogany | N |
| Mocha | MOCH |
| Natural Maple | D |
| Pinnacle | PINC |
| Shaker Cherry | F |
| Sterling Ash | LSA1 |

L2 LAMINATE COLOR CODE

| | |
|----------------|-------------|
| Lowell Ash | LLA1 |
| Natural Recon | LNR1 |
| Phantom Ecrú | LPE1 |
| Portico Teak | LPT1 |
| Skyline Walnut | LSW1 |

**Specify for models HML2ST and HML2STDF only*

HON BRANDED FABRICS

| GRADE 1 | GRADE 2 | GRADE 3 | GRADE L |
|------------|-----------------|-----------|----------------|
| Apex | Appoint Seating | In Season | Denver Leather |
| Centurion | Blume | Moxie | |
| Compass | Clyde | Parker | |
| Contourett | Dotty | Purl | |
| Dapper | Rush | Quill | |
| Ensemble | Seed | | |
| Hamilton | Spin Seating | | |
| Inertia | Whisper Vinyl | | |
| Optic | | | |
| Pebble | | | |

For a complete list of fabrics, including partnership fabrics, go to hon.com/fabricsandfinishes.

Reference Fabric Color Combinations on pages 18-22 for color codes and legend on page 19 for lead times. For additional HON to Supply COM fabric grade pricing, go to honready.hon.com and click on the HON to Supply COM link.

i Due to the inherent characteristics of upholstery materials, the seat of Grove[®] may become more relaxed to show wrinkles over time.

MULTI-FABRIC COM YARDAGE

Due to fabric pattern nesting and potential reduction of fabric yield, some multi-fabric models may require more total yardage than standard models.

| MODEL | COM (ARMLESS) | | COM (w/ STRAIGHT ARMS) | | COM (w/ TAPERED ARMS) | |
|----------|---------------|------|------------------------|------|-----------------------|------|
| | Back | Seat | Back | Seat | Back | Seat |
| HML1S | 3 | | 5 | | 5 | |
| HML1SDF | 1.5 | 2 | 4 | 2 | 4 | 2 |
| HML2S | 5 | | 7.5 | | 7.5 | |
| HML2SDF | 2 | 3.5 | 4 | 3.5 | 4 | 3.5 |
| HML2ST | 6 | | 8 | | 8 | |
| HML2STDF | 3 | 3.5 | 5.5 | 3.5 | 5.5 | 3.5 |
| HML3 | 7.5 | | 9 | | 9.5 | |
| HML3DF | 3 | 5 | 5.5 | 5 | 5.5 | 5 |

HML1S

LOUNGE

Single Seat

DIMENSIONS

| | | | |
|-----------------------------|-----|-----------------------------------|------------|
| Depth: | 31½ | Ship Weight (armless): | 61 |
| Height: | 35 | Ship Weight (with straight arms): | 77 |
| Seat Width: | 23½ | Ship Weight (with tapered arms): | 85 |
| Back Width: | 23½ | Cube (armless): | 19.8 |
| Back Height: | 19 | Cube (with straight arms): | 19.8 |
| Width (armless): | 23½ | Cube (with tapered arms): | 19.8 |
| Width (with straight arms): | 29¾ | COM: | See |
| Width (with tapered arms): | 35 | | page 315 |
| Arm Width: | 23½ | Weight Rating: | 300 lbs. |
| Seat to Floor Height: | 16 | | (per seat) |
| Usable Seat Depth: | 18¾ | | |

FABRIC PRICE CODES

| | | | |
|----------|---------------|-----------|---------------|
| 1 | \$1474 | 8 | \$1888 |
| 2 | \$1546 | 9 | \$1942 |
| 3 | \$1618 | 10 | \$1996 |
| 4 | \$1672 | 11 | \$2050 |
| 5 | \$1726 | 12 | \$2104 |
| 6 | \$1780 | L | \$2074 |
| 7 | \$1834 | | |

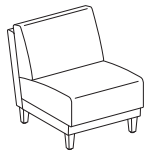

Armless

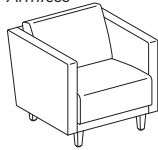

Straight Arms

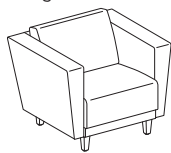

Tapered Arms

HML2S

LOUNGE

Two-Seat

DIMENSIONS

| | | | |
|-----------------------------|-----|-----------------------------------|------------|
| Depth: | 31½ | Ship Weight (armless): | 100 |
| Height: | 35 | Ship Weight (with straight arms): | 116 |
| Seat Width: | 48 | Ship Weight (with tapered arms): | 124 |
| Back Width: | 48 | Cube (armless): | 35.6 |
| Back Height: | 19 | Cube (with straight arms): | 35.6 |
| Width (armless): | 48 | Cube (with tapered arms): | 35.6 |
| Width (with straight arms): | 54¼ | COM: | See |
| Width (with tapered arms): | 59½ | | page 315 |
| Arm Width: | 48 | Weight Rating: | 300 lbs. |
| Seat to Floor Height: | 16 | | (per seat) |
| Usable Seat Depth: | 18¾ | | |

FABRIC PRICE CODES

| | | | |
|----------|---------------|-----------|---------------|
| 1 | \$2329 | 8 | \$3019 |
| 2 | \$2449 | 9 | \$3109 |
| 3 | \$2569 | 10 | \$3199 |
| 4 | \$2659 | 11 | \$3289 |
| 5 | \$2749 | 12 | \$3379 |
| 6 | \$2839 | L | \$3329 |
| 7 | \$2929 | | |

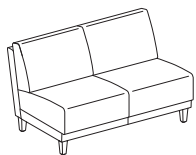

Armless

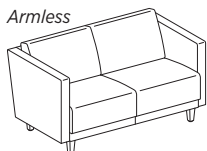

Straight Arms

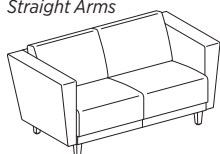

Tapered Arms

HON Recommendation: HML1S.A.PNS__TS.P7A - List Price \$1846

HOW TO SPECIFY

| | | | | |
|---|---|--|---|---|
| Select Model Number HML1S | Select Arm Type N Armless A Straight Arms (+ \$300) B Tapered Arms (+ \$350) A | Select Fabric See page 315 PNS007 | Select Leg Type TS Tapered Square TR Tapered Round TS | Select Leg Color PR8 Textured Silver P7A Textured Charcoal H Bourbon Cherry (+ \$100) F Shaker Cherry (+ \$100) N Mahogany (+ \$100) C Harvest (+ \$100) D Natural Maple (+ \$100) LK11 Kingswood Walnut (+ \$100) LSA1 Sterling Ash (+ \$100) P7A |
|---|---|--|---|---|

! Leg options - Tapered Square (TS) and Tapered Round (TR) are available in 2 poly and 13 woodgrain options.



HML3S

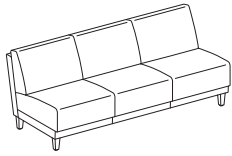

Armless

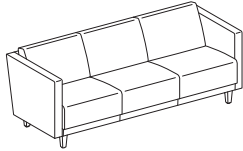

Straight Arms

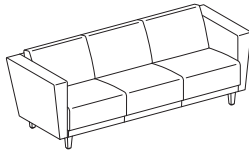

Tapered Arms

LOUNGE

Three-Seat

DIMENSIONS

| | | | |
|-----------------------------|-----|-----------------------------------|------------|
| Depth: | 31½ | Ship Weight (armless): | 141 |
| Height: | 35 | Ship Weight (with straight arms): | 157 |
| Seat Width: | 71½ | Ship Weight (with tapered arms): | 165 |
| Back Width: | 71½ | Cube (armless): | 48.9 |
| Back Height: | 19 | Cube (with straight arms): | 48.9 |
| Width (armless): | 71½ | Cube (with tapered arms): | 48.9 |
| Width (with straight arms): | 77½ | COM: | See |
| Width (with tapered arms): | 82½ | | page 315 |
| Arm Width: | 71½ | Weight Rating: | 300 lbs. |
| Seat to Floor Height: | 16 | | (per seat) |
| Usable Seat Depth: | 18¾ | | |

FABRIC PRICE CODES

| | | | |
|----------|---------------|-----------|---------------|
| 1 | \$3124 | 8 | \$4159 |
| 2 | \$3304 | 9 | \$4294 |
| 3 | \$3484 | 10 | \$4429 |
| 4 | \$3619 | 11 | \$4564 |
| 5 | \$3754 | 12 | \$4699 |
| 6 | \$3889 | L | \$4624 |
| 7 | \$4024 | | |

HON Recommendation: HML3S.A.PNS__TS.P7A - List Price \$3604

HOW TO SPECIFY

| | | | | |
|-----------------------------------|--|---|--|--|
| <p>Select Model Number</p> | <p>Select Arm Type</p> <p>N Armless A Straight Arms (+ \$300) B Tapered Arms (+ \$350)</p> | <p>Select Fabric</p> <p>See page 315</p> | <p>Select Leg Type</p> <p>TS Tapered Square TR Tapered Round</p> | <p>Select Leg Color</p> <p>PR8 Textured Silver P7A Textured Charcoal H Bourbon Cherry (+ \$100) F Shaker Cherry (+ \$100) N Mahogany (+ \$100) C Harvest (+ \$100) D Natural Maple (+ \$100) LK11 Kingswood Walnut (+ \$100) LSA1 Sterling Ash (+ \$100)</p> |
| <p>H M L 3 S .</p> | <p>A .</p> | <p>P N S 0 0 7 .</p> | <p>T S .</p> | <p>P 7 A</p> |

! Leg options - Tapered Square (TS) and Tapered Round (TR) are available in 2 poly and 13 woodgrain options.

HML2ST

LOUNGE

Two-Seat with Table

DIMENSIONS

| | | | |
|-----------------------------|-----|-----------------------------------|------------|
| Depth: | 31½ | Ship Weight (armless): | 146 |
| Height: | 35 | Ship Weight (with straight arms): | 162 |
| Seat Width: | 71½ | Ship Weight (with tapered arms): | 170 |
| Back Width: | 71½ | Cube (armless): | 48.9 |
| Back Height: | 19 | Cube (with straight arms): | 48.9 |
| Width (armless): | 71½ | Cube (with tapered arms): | 48.9 |
| Width (with straight arms): | 77½ | COM: | See |
| Width (with tapered arms): | 82½ | | page 315 |
| Arm Width: | 71½ | Weight Rating: | 300 lbs. |
| Seat to Floor Height: | 16 | | (per seat) |
| Usable Seat Depth: | 18¾ | | |

FABRIC PRICE CODES

| | | | |
|----------|---------------|-----------|---------------|
| 1 | \$3366 | 8 | \$4194 |
| 2 | \$3510 | 9 | \$4302 |
| 3 | \$3654 | 10 | \$4410 |
| 4 | \$3762 | 11 | \$4518 |
| 5 | \$3870 | 12 | \$4626 |
| 6 | \$3978 | L | \$4566 |
| 7 | \$4086 | | |

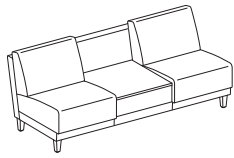

Armless

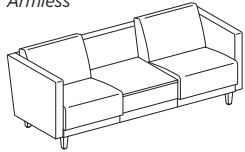

Straight Arms

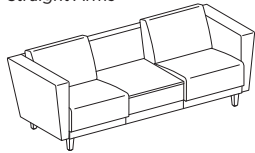

Tapered Arms

NOTES: Offers a table between the seats that provides separation and a usable worksurface. Table available with two grommet and an accessory port option.

HON Recommendation: HML2ST.A.PNS___.TS.P7A.N.G1.0 - List Price \$3850

HOW TO SPECIFY

| Select Model Number | Select Arm Type | Select Fabric | Select Leg Type | Select Leg Color | Select Laminate | Select Cut Out | Accessory Port Location |
|---------------------|---|---------------|---|--|--|---|---|
| HML2ST | <ul style="list-style-type: none"> N Armless A Straight Arms (+ \$300) B Tapered Arms (+ \$350) | See page 315 | <ul style="list-style-type: none"> TS Tapered Square TR Tapered Round | <ul style="list-style-type: none"> PR8 Textured Silver P7A Textured Charcoal H Bourbon Cherry (+ \$100) F Shaker Cherry (+ \$100) N Mahogany (+ \$100) C Harvest (+ \$100) D Natural Maple (+ \$100) LK11 Kingswood Walnut (+ \$100) LSA1 Sterling Ash (+ \$100) | See Chart on page 314 L2 (+ \$125) | <ul style="list-style-type: none"> N No Cutout G Round Grommet Cutout (+ \$30) G1 Pop-Up Port Cutout (+ \$40) | <ul style="list-style-type: none"> 0 No Port 2 Two Tablet Ports Opposite (+ \$20) |
| HML2ST | A | PNS007 | TS | P7A | N | G1 | 0 |

! Leg options - Tapered Square (TS) and Tapered Round (TR) are available in 2 poly and 8 woodgrain options.



HML1SDF

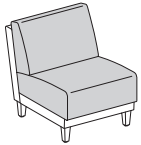

Armless

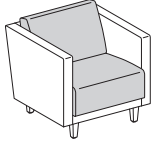

Straight Arms

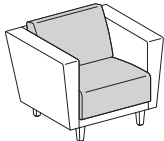

Tapered Arms

SINGLE SEAT LOUNGE

Multi-Fabric

DIMENSIONS

| | | | |
|-----------------------------|-----|-----------------------------------|------------|
| Depth: | 31½ | Ship Weight (armless): | 61 |
| Height: | 35 | Ship Weight (with straight arms): | 77 |
| Seat Width: | 23½ | Ship Weight (with tapered arms): | 85 |
| Back Width: | 23½ | Cube (armless): | 19.8 |
| Back Height: | 19 | Cube (with straight arms): | 19.8 |
| Width (armless): | 23½ | Cube (with tapered arms): | 19.8 |
| Width (with straight arms): | 29¾ | COM: | See |
| Width (with tapered arms): | 35 | | page 315 |
| Arm Width: | 23½ | Weight Rating: | 300 lbs. |
| Seat to Floor Height: | 16 | | (per seat) |
| Usable Seat Depth: | 18¾ | | |

FABRIC PRICE CODES

| | | | |
|--------------------------------|---------------|------------------------|-------------------------------|
| 1 | \$1567 | | |
| <i>Add to Base Price Above</i> | | | |
| | | Frame/ Arms | Back/Seat Cushions |
| 2 | \$36 | | \$48 |
| 3 | \$72 | | \$96 |
| 4 | \$99 | | \$132 |
| 5 | \$126 | | \$168 |
| 6 | \$153 | | \$204 |
| 7 | \$180 | | \$240 |
| 8 | \$207 | | \$276 |
| 9 | \$234 | | \$312 |
| 10 | \$261 | | \$348 |
| 11 | \$288 | | \$384 |
| 12 | \$315 | | \$420 |
| L | \$300 | | \$400 |

For multi-fabric models, start with the base price, then add the additional amount for the back and seat from the corresponding matrix to determine the final list price. Choose any combination of fabric grades for the back and seat.

Example: HML1SDF base price (\$1567) + Grade 2 frame/arms fabric (add \$36) + Grade 4 back/seat fabric (add \$132) = Total \$1735 List
 HML1SDF base price (\$1567) + Grade 5 frame/arms fabric (add \$126) + Grade 3 back/seat fabric (add \$96) = Total \$1789 List

HON Recommendation: HML1SDF.A.PNS___.PNS___.TS.P7A - List Price \$1951

HOW TO SPECIFY

| Select Model Number | Select Arm Type | Select Frame/Arms Fabric | Select Back/Seat Cushions Fabric | Select Leg Type | Select Leg Color |
|---------------------|--|--------------------------|----------------------------------|---------------------------------------|---|
| HML1SDF | N Armless A Straight Arms (+ \$300) B Tapered Arms (+ \$350) | See page 315 | See page 315 | TS Tapered Square TR Tapered Round | PR8 Textured Silver P7A Textured Charcoal H Bourbon Cherry (+ \$100) F Shaker Cherry (+ \$100) N Mahogany (+ \$100) C Harvest (+ \$100) D Natural Maple (+ \$100) LK11 Kingswood Walnut (+ \$100) LSA1 Sterling Ash (+ \$100) |
| HML1SDF | A | PNS004 | PNS007 | TS | P7A |

! Leg options - Tapered Square (TS) and Tapered Round (TR) are available in 2 poly and 8 woodgrain options.



HML2SDF

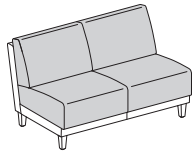

Armless

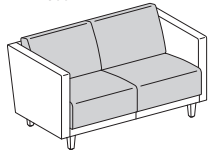

Straight Arms

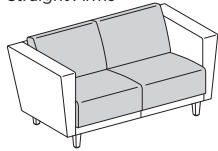

Tapered Arms

TWO-SEAT LOUNGE

Multi-Fabric

DIMENSIONS

| | | | |
|-----------------------------|-----|-----------------------------------|------------------------------------|
| Depth: | 31½ | Ship Weight (armless): | 100 |
| Height: | 35 | Ship Weight (with straight arms): | 116 |
| Seat Width: | 48 | Ship Weight (with tapered arms): | 124 |
| Back Width: | 48 | Cube (armless): | 35.6 |
| Back Height: | 19 | Cube (with straight arms): | 35.6 |
| Width (armless): | 48 | Cube (with tapered arms): | 35.6 |
| Width (with straight arms): | 54¼ | COM: | See |
| Width (with tapered arms): | 59½ | Weight Rating: | page 315 300 lbs. (per seat) |
| Arm Width: | 48 | | |
| Seat to Floor Height: | 16 | | |
| Usable Seat Depth: | 18¾ | | |

FABRIC PRICE CODES

1 \$2340

Add to Base Price Above

| | Frame/ Arms | Back/Seat Cushions |
|----|----------------|-----------------------|
| 2 | \$60 | \$84 |
| 3 | \$120 | \$168 |
| 4 | \$165 | \$231 |
| 5 | \$210 | \$294 |
| 6 | \$255 | \$357 |
| 7 | \$300 | \$420 |
| 8 | \$345 | \$483 |
| 9 | \$390 | \$546 |
| 10 | \$435 | \$609 |
| 11 | \$480 | \$672 |
| 12 | \$525 | \$735 |
| L | \$500 | \$700 |

For multi-fabric models, start with the base price, then add the additional amount for the back and seat from the corresponding matrix to determine the final list price. Choose any combination of fabric grades for the back and seat.

Example: HML2SDF base price (\$2340) + Grade 2 frame/arms fabric (add \$60) + Grade 4 back/seat fabric (add \$231) = Total \$2631 List
 HML2SDF base price (\$2340) + Grade 5 frame/arms fabric (add \$210) + Grade 3 back/seat fabric (add \$168) = Total \$2718 List

HON Recommendation: HML2SDF.A.PNS__PNS__TS.P7A - List Price \$2784

HOW TO SPECIFY

| Select Model Number | Select Arm Type | Select Frame/Arms Fabric | Select Back/Seat Cushions Fabric | Select Leg Type | Select Leg Color |
|---------------------|--|--------------------------|----------------------------------|---------------------------------------|---|
| HML2SDF | N Armless A Straight Arms (+ \$300) B Tapered Arms (+ \$350) | See page 315 | See page 315 | TS Tapered Square TR Tapered Round | PR8 Textured Silver P7A Textured Charcoal H Bourbon Cherry (+ \$100) F Shaker Cherry (+ \$100) N Mahogany (+ \$100) C Harvest (+ \$100) D Natural Maple (+ \$100) LK11 Kingswood Walnut (+ \$100) LSA1 Sterling Ash (+ \$100) |
| HML2SDF | A | PNS004 | PNS007 | TS | P7A |

! Leg options - Tapered Square (TS) and Tapered Round (TR) are available in 2 poly and 8 woodgrain options.



HML3SDF

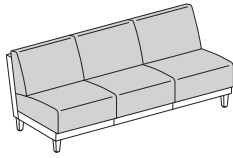

Armless

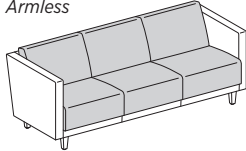

Straight Arms

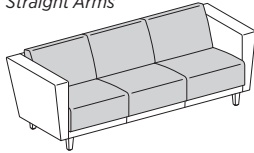

Tapered Arms

THREE-SEAT LOUNGE

Multi-Fabric

DIMENSIONS

| | | | |
|-----------------------------|-----|-----------------------------------|------------|
| Depth: | 31½ | Ship Weight (armless): | 141 |
| Height: | 35 | Ship Weight (with straight arms): | 157 |
| Seat Width: | 71½ | Ship Weight (with tapered arms): | 165 |
| Back Width: | 71½ | Cube (armless): | 48.9 |
| Back Height: | 19 | Cube (with straight arms): | 48.9 |
| Width (armless): | 71½ | Cube (with tapered arms): | 48.9 |
| Width (with straight arms): | 77½ | COM: | See |
| Width (with tapered arms): | 82½ | Weight Rating: | page 315 |
| Arm Width: | 71½ | | 300 lbs. |
| Seat to Floor Height: | 16 | | (per seat) |
| Usable Seat Depth: | 18¾ | | |

FABRIC PRICE CODES

| | | | |
|--------------------------------|---------------|------------------------|-------------------------------|
| 1 | \$3221 | | |
| <i>Add to Base Price Above</i> | | | |
| | | Frame/ Arms | Back/Seat Cushions |
| 2 | \$72 | | \$132 |
| 3 | \$144 | | \$264 |
| 4 | \$198 | | \$363 |
| 5 | \$252 | | \$462 |
| 6 | \$306 | | \$561 |
| 7 | \$360 | | \$660 |
| 8 | \$414 | | \$759 |
| 9 | \$468 | | \$858 |
| 10 | \$522 | | \$957 |
| 11 | \$576 | | \$1056 |
| 12 | \$630 | | \$1155 |
| L | \$600 | | \$1100 |

For multi-fabric models, start with the base price, then add the additional amount for the back and seat from the corresponding matrix to determine the final list price. Choose any combination of fabric grades for the back and seat.

Example: HML3SDF base price (\$3221) + Grade 2 frame/arms fabric (add \$72) + Grade 4 back/seat fabric (add \$363) = Total \$3656 List
 HML3SDF base price (\$3221) + Grade 5 frame/arms fabric (add \$252) + Grade 3 back/seat fabric (add \$264) = Total \$3737 List

HON Recommendation: HML3SDF.A.PNS__PNS__.TS.P7A - List Price \$3725

HOW TO SPECIFY

| Select Model Number | Select Arm Type | Select Frame/Arms Fabric | Select Back/Seat Cushions Fabric | Select Leg Type | Select Leg Color |
|---------------------|--|--------------------------|----------------------------------|---------------------------------------|---|
| HML3SDF | N Armless A Straight Arms (+ \$300) B Tapered Arms (+ \$350) | See page 315 | See page 315 | TS Tapered Square TR Tapered Round | PR8 Textured Silver P7A Textured Charcoal H Bourbon Cherry (+ \$100) F Shaker Cherry (+ \$100) N Mahogany (+ \$100) C Harvest (+ \$100) D Natural Maple (+ \$100) LK11 Kingswood Walnut (+ \$100) LSA1 Sterling Ash (+ \$100) |
| HML3SDF | A | PNS004 | PNS007 | TS | P7A |

! Leg options - Tapered Square (TS) and Tapered Round (TR) are available in 2 poly and 8 woodgrain options.



HML2STDF

TWO-SEAT WITH TABLE

Multi-Fabric

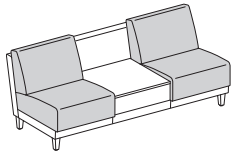

Armless

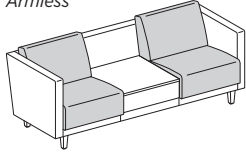

Straight Arms

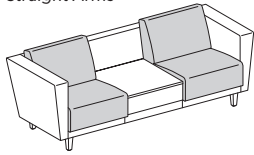

Tapered Arms

DIMENSIONS

| | | | |
|-----------------------------|-----|-----------------------------------|---------------------|
| Depth: | 31½ | Ship Weight (armless): | 146 |
| Height: | 35 | Ship Weight (with straight arms): | 162 |
| Seat Width: | 71½ | Ship Weight (with tapered arms): | 170 |
| Back Width: | 71½ | Cube (armless): | 48.9 |
| Back Height: | 19 | Cube (with straight arms): | 48.9 |
| Width (armless): | 71½ | Cube (with tapered arms): | 48.9 |
| Width (with straight arms): | 77½ | COM: | See page 315 |
| Width (with tapered arms): | 82½ | Weight Rating: | 300 lbs. (per seat) |
| Arm Width: | 71½ | | |
| Seat to Floor Height: | 16 | | |
| Usable Seat Depth: | 18¾ | | |

FABRIC PRICE CODES

| | | | |
|--------------------------------|-------------------|---------------------------|--|
| 1 | \$3461 | | |
| <i>Add to Base Price Above</i> | | | |
| | Frame/Arms | Back/Seat Cushions | |
| 2 | \$72 | \$84 | |
| 3 | \$144 | \$168 | |
| 4 | \$198 | \$231 | |
| 5 | \$252 | \$294 | |
| 6 | \$306 | \$357 | |
| 7 | \$360 | \$420 | |
| 8 | \$414 | \$483 | |
| 9 | \$468 | \$546 | |
| 10 | \$522 | \$609 | |
| 11 | \$576 | \$672 | |
| 12 | \$630 | \$735 | |
| L | \$600 | \$700 | |

NOTES: Offers a table between the seats that provides separation and a usable worksurface. Table available with two grommet and an accessory port option.

HON Recommendation: HML2STDF.A.PNS__PNS__TS.P7A.N.G1.0 - List Price \$3957

HOW TO SPECIFY

| Select Model Number | Select Arm Type | Select Frame/Arms Fabric | Select Back/Seat Cushions Fabric | Select Leg Type | Select Leg Color | Select Laminate | Select Cut Out | Accessory Port Location |
|---------------------|---|--------------------------|----------------------------------|---|--|---|---|---|
| | N Armless A Straight Arms (+ \$300) B Tapered Arms (+ \$350) | See page 315 | See page 315 | TS Tapered Square TR Tapered Round | PR8 Textured Silver P7A Textured Charcoal H Bourbon Cherry (+ \$100) F Shaker Cherry (+ \$100) N Mahogany (+ \$100) C Harvest (+ \$100) D Natural Maple (+ \$100) LK11 Kingswood Walnut (+ \$100) LSA1 Sterling Ash (+ \$100) | <i>See Chart on page 314</i> L2 (+ \$125) | N No Cutout G Round Grommet Cutout (+ \$30) G1 Pop-Up Port Cutout (+ \$40) | 0 No Port 2 Two Tablet Ports Opposite (+ \$20) |
| HML2STDF | A | PNS004 | PNS007 | TS | P7A | N | G1 | 0 |

! Leg options - Tapered Square (TS) and Tapered Round (TR) are available in 2 poly and 8 woodgrain options.

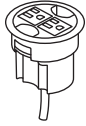
HGRMTAC

SIN 33721T

POWER HUB**3" Grommet Mount, 6' Cord****DIMENSIONS**Ship Weight: 1.3
Cube: 0.2**LIST PRICE****\$126**

NOTES: Fits in 3" round grommet holes. Field installed with Plug-and-play ease. Two grounded AC power outlets. Includes 6' cord with three-prong plug.

ⓘ Available in black only (no color designation so use .X)

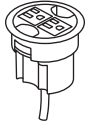
HGRMTAC2

SIN 33721T

3" ROUND POWER GROMMET**2 Outlets, 10' Cord****DIMENSIONS**Ship Weight: 1.5
Cube: 0.2**LIST PRICE****\$159**

NOTES: Power Modules will also work with standing-height applications for 10500 Series™ and Voi® desks. Optional Memory Control allows preset worksurface heights for consistency. Ships separately. Dynamic load capacity when worksurface is moving is 300 lbs. Includes 10' cord with three-prong plug. Fits in 3" round grommet holes on the following product lines: Coordinate™, Huddle, Motivate®, all laminate and veneer casegoods series, and Systems Worksurfaces. Two grounded AC power outlets. Field installed with Plug-and-play ease.

ⓘ Available in black finish only, no specification needed.

HGRMTUSB2

SIN 33721T

POWER/USB HUB**3" Grommet Mount****DIMENSIONS**Ship Weight: 1.3 ⓘ
Cube: 0.2**LIST PRICE****\$250**

NOTES: One grounded AC power outlet with 2 USB ports. UL Listed.

ⓘ Available in black only (no color designation so use .X)

HFTTAL14

SIN 33721

TABLET ACCESSORY**Laminate****DIMENSIONS**Diameter: 14 Ship Weight: 6.0
Height from Table Top: 10 Cube: 2.5**LIST PRICE****\$402**

NOTES: Use with Collaborative Cube and Cylinder tables for additional workspace. Attaches to tables through ports. Multiple port location options are available. Tablet pivots/swivels toward the user.

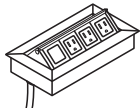
HTG1PWR-3P-1B

SIN 33721

POP-UP PORT**DIMENSIONS**Ship Weight: 5.0
Cube: 0.3**LIST PRICE****\$424**

NOTES: Fits into 4" x 8" cutout. Specify G1 cutout in table top. Pop-up Port provides three power ports and one blank data receptacle. Sits flush with worksurface when closed. Finish is anodized aluminum. Includes 6' cord with three-prong plug.

HON Recommendation: HTG1PWR-3P-1B - List Price \$424

HOW TO SPECIFY

Select
Model Number

H G R M T A C

GUESTSTACKER® 4030 Series

Want to see more? Scan here
to check out hon.com.



GuestStacker Stacking Chair shown in Regatta.

GUESTSTACKER® 4030 SERIES

Support your people with a comfortable chair whenever needed, then quickly clear the room. GuestStacker helps you make the most of valuable floor space by stacking six high on the floor or 28 high on a cart. Each set of four chairs provides ergonomic support to users with a contoured seat and back that are molded to fit the natural curves of your body. When you need to put guests at ease for any length of time, you need GuestStacker chairs.



FEATURES

- Ships four chairs per carton.
- Chairs stack six high on the floor.
- Copolymer resin seat and back shell.
- Integrated lumbar support delivers long-lasting comfort.
- Wall-saver design protects walls and cabinets.
- Tubular steel frame adds durability.
- Optional ganging glides create straight rows.
- Stacks up to 28 high on HON Model 4033 Cart.
- Ships fully assembled.
- Warranted for users up to 300 lbs.



GUESTSTACKER® 4030 Series

H4031



STACKING CHAIRS

Textured Copolymer Seat & Back
Painted Legs — Black (T) ONLY

DIMENSIONS

| | | | |
|--------------|-----|-----------------------|----------|
| Depth: | 21½ | Seat to Floor Height: | 17½ |
| Width: | 21 | Usable Seat Depth: | 17½ |
| Height: | 31 | Ship Weight: | 51 |
| Seat Depth: | 19 | Cube: | 12.9 |
| Seat Width: | 18 | Weight Rating: | 300 lbs. |
| Back Width: | 20 | | |
| Back Height: | 11 | | |

LIST PRICE PER CARTON

\$712
(reference single unit @ \$178.00)

- ⊕ 4030 Series is ordered and shipped four (4) chairs per carton. Pricing shown is per carton. Each set of four (one carton), must have the same shell/frame color combination. Ordering 2 of Model H4031 will result in 2 cartons being shipped, giving you 8 chairs.
- ⚠ Shipped fully assembled — 4 chairs per carton. All GuestStacker® shell colors are CA Technical Bulletin 133 compliant (no upcharge).

H4033

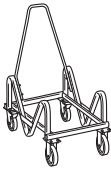

CART FOR STACKING CHAIRS

DIMENSIONS

| | | | |
|---------|-----|--------------|------|
| Depth: | 35½ | Ship Weight: | 40 Ⓢ |
| Width: | 21¾ | Cube: | 8.9 |
| Height: | 37¾ | | |

LIST PRICE

\$598

- NOTES: Holds 28 stack chairs (6'-8"), some assembly required. (Chairs stack 6 high without cart.)
⚠ Specify Black paint (T) ONLY.

H4039

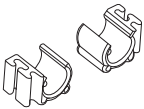

GANGING CHAIR GLIDES

DIMENSIONS

| | | |
|-----------|--------------|------|
| Box of 48 | Ship Weight: | 1 Ⓢ |
| | Cube: | 0.04 |

LIST PRICE

\$120

HON Recommendation: H4031.LA.T - List Price \$712

HOW TO SPECIFY

| | | |
|--|---|--|
| <p>Select Model Number</p> <p>H 4 0 3 1 .</p> | <p>Select Shell Color</p> <p>LA Lava MB Mulberry ON Onyx RE Regatta</p> <p>L A .</p> | <p>Select Frame</p> <p>T Black</p> <p>T</p> |
|--|---|--|

NOTES



Ignition® Seating.

IGNITION®

People come in all shapes and sizes, which is why Ignition does as well. From guest and lounge chairs to executive seating, Ignition allows you to mix and match adjustment features, back height, lumbar, and other options to fit your chair to your needs. It's the easy, affordable way to furnish an entire workplace in style and comfort. Ignition fits who you are, where you work and how you work.



FEATURES

IGNITION® 2.0

- Choice of upholstered, 4-Way Stretch mesh or ReActiv® back options.
- ReActiv® back features zonal comfort that delivers optimal support and flexibility.
- The unique hammock-like inner support allows the upholstered back version to feature a slim profile and provide built-in comfort.
- Optional adjustable lumbar allows users to tailor their support.
- 8 different adjustable lumbar colors available on 4-Way Stretch mesh and ReActiv® task chair models.
- Passive movement back adjusts with you.
- Multiple arm options to accommodate user requirements.
- Available in 7 colors of 4-Way Stretch mesh and 3 ReActiv® colors.
- Molded foam seat for better support and added comfort.
- Black, Titanium, and Designer White frame.
- Mesh seat option with waterfall seat available to reduce pressure points and provide breathability.
- Warranted for users up to 300 lbs., 450 lbs. for Big & Tall.



IGNITION®

- Ignition Series seating addresses the needs of the total office with Executive, Task, Stool, Guest and Lounge Seating Solutions.
- Three different back sizes, three different controls and multiple arm options to fit you and how you work.
- Back height adjustment moves the back up or down to fit various body sizes.
- Contoured back on multi-purpose seating offers greater comfort than typical stack chairs or stools.
- Warranted for users up to 300 lbs., 450 lbs. for Big & Tall.
- Multi-purpose chair stacks four high.

IGNITION® Options

MODEL OPTIONS

HITLM

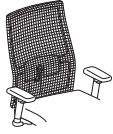

Task Low-Back

4-Way Stretch Mesh Back, Pneumatic, Swivel, Synchro-tilt, Tilt Tension, Tilt Lock, Optional Lumbar Support

HITSM

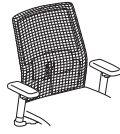

Task Low-Back Stool

4-Way Stretch Mesh Back, Pneumatic, Swivel, Synchro-tilt, Tilt Tension, Tilt Lock, Optional Lumbar Support

HITLRA



Task Low-Back ReActiv®

ReActiv® Back, Pneumatic, Swivel, Synchro-tilt, Tilt Tension, Tilt Lock, Optional Lumbar Support

HITSRA



Task Low-Back Stool ReActiv®

ReActiv® Back, Pneumatic, Swivel, Synchro-tilt, Tilt Tension, Tilt Lock, Optional Lumbar Support

HIWMM



Task Mid-Back

4-Way Stretch Mesh Back, Pneumatic, Swivel, Synchro-tilt, Tilt Tension, Tilt Lock, Optional Lumbar Support

HIWMMHR



Task Mid-Back w/Headrest

4-Way Stretch Mesh Back, Pneumatic, Swivel, Synchro-tilt, Tilt Tension, Tilt Lock, Optional Lumbar Support, Headrest

HIWMS



Task Mid-Back w/Mesh Seat

4-Way Stretch Mesh Back, Pneumatic, Swivel, Synchro-tilt, Tilt Tension, Tilt Lock, Optional Lumbar Support, Mesh Seat

HIWMBT



Task Mid-Back Big & Tall

4-Way Stretch Mesh Back, Pneumatic, Swivel, Synchro-tilt, Tilt Tension, Tilt Lock, Optional Lumbar Support

HIWMRA



Task Mid-Back ReActiv®

ReActiv® Back, Pneumatic, Swivel, Synchro-tilt, Tilt Tension, Tilt Lock, Optional Lumbar Support

HIWMMU



Upholstered Mid-Back

Upholstered Back, Pneumatic, Swivel, Synchro-tilt, Tilt Tension, Tilt Lock

HIWMUL



Upholstered Mid-Back with Lumbar Support

Upholstered Back, Pneumatic, Swivel, Synchro-tilt, Tilt Tension, Tilt Lock, Adjustable Lumbar

HIGS6

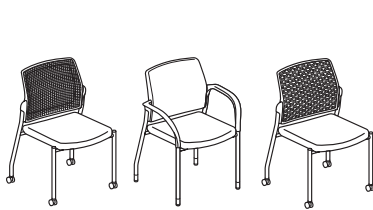

Multi-Purpose

Four Legs

HISB6

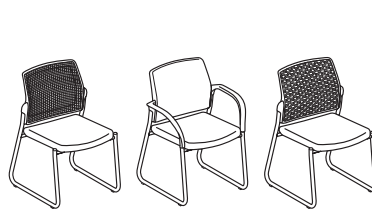

Multi-Purpose

Sled Base

HICS7

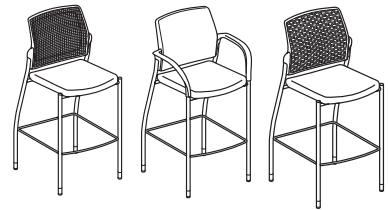

Café-Height Stool

Four Legs

HIGS6DF - Multi-Fabric

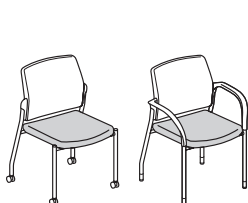

Multi-Purpose

Four Legs

HISB6DF - Multi-Fabric

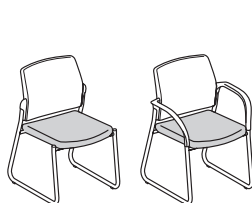

Multi-Purpose

Sled Base

HICS7DF - Multi-Fabric

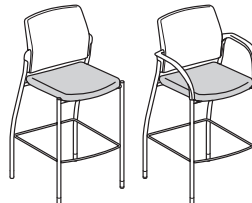

Café-Height Stool

Four Legs

MODEL OPTIONS

HIGCL



Guest Chair

Fixed Arms, Glides

HIB50

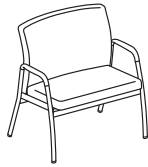

Bariatric Lounge

Fixed Arms, Glides

HITL1



Task Low-Back

Pneumatic, Back Height Adjustment, Swivel, Tilt, Tilt Tension, Tilt Lock

HITL2



Task Low-Back

Pneumatic, Back Height Adjustment, Synchro-tilt, Tilt Tension, Tilt Lock, Seat Glide

HITL3



Task Low-Back

Pneumatic, Back Height Adjustment, Synchro-tilt, Back Angle Adjustment, Tilt Tension, Tilt Lock, Seat Glide

HITS5



Task Stool

Pneumatic, Swivel Back Height Adjustment, Adjustable Footrest

HIWM1



Mid-Back

Pneumatic, Back Height Adjustment, Swivel, Tilt, Tilt Tension, Tilt Lock

HIWM2



Mid-Back

Pneumatic, Back Height Adjustment, Synchro-tilt, Tilt Tension, Tilt Lock, Seat Glide

HIWM3



Mid-Back

Pneumatic, Back Height Adjustment, Synchro-tilt, Back Angle Adjustment, Tilt Tension, Tilt Lock, Seat Glide

HIEH1



Executive High-Back

Pneumatic, Back Height Adjustment, Swivel, Tilt, Tilt Tension, Tilt Lock

HIEH2



Executive High-Back

Pneumatic, Back Height Adjustment, Synchro-tilt, Tilt Tension, Seat Glide

HIEH3



Executive High-Back

Pneumatic, Back Height Adjustment, Synchro-tilt, Back Angle Adjustment, Tilt Tension, Seat Glide

HIWM8

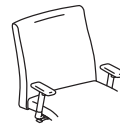











Task Mid-Back





Big and Tall, Pneumatic, Swivel-tilt, Tilt Tension



IGNITION® 2.0

Options

| ARM STYLE | CODE | DESCRIPTION | PRICE |
|---|----------|--------------------------------------|---------------|
|  | N | Armless | +\$0 |
|  | F | Fixed Arms | +\$65 |
|  | A | Height and Width Adjustable Arms | +\$85 |
|  | V | All-Adjustable Arms (includes Pivot) | +\$130 |
|  | P | Fixed Polished Aluminum Arms | +\$175 |

| MECHANISM | CODE | DESCRIPTION | PRICE |
|---|-----------|--|---------------|
|  | Y0 | Synchro-Tilt A, E, J, K, L | +\$0 |
|  | Y1 | Synchro-Tilt w/ Seat Slider A, D, E, J, K, L | +\$20 |
|  | Y2 | Advanced Synchro-Tilt A, D, E, J, L, A-D | +\$65 |
|  | Y3 | Synchro-Tilt with Independent Back Angle A, D, E, J, L, A-E | +\$105 |
|  | Y4 | Synchro-Tilt (Big & Tall models only) A, D, E, J, L, A-D | +\$0 |
|  | W2 | Weight-Activated Synchro-Tilt w/ Seat Slider A, D, E, L, P | +\$65 |

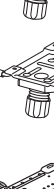
| CASTERS | CODE | DESCRIPTION | PRICE |
|---|-----------|---|--------------|
|  | H | Black Hard Caster | +\$0 |
|  | S | Black All-Surface Caster | +\$40 |
|  | R | Black Roll Control Caster | +\$50 |
|  | TS | Titanium All-Surface Caster | +\$40 |
|  | A | Black All-Surface Caster (Big & Tall models only) | +\$0 |

| | | | |
|---|-----------|---|--------------|
|  | S0 | Limited Recline Synchro-Tilt A, E, J, K, L | +\$0 |
|  | S1 | Limited Recline Synchro-Tilt w/ Seat Slider A, D, E, J, K, L | +\$20 |
| <i>*Only available on HITSM</i> | | | |
|  | S2 | Limited Recline Advanced Synchro-Tilt A, D, E, J, L, A-D | +\$65 |
| <i>*Only available on HIWMMS, HIWMMSKD</i> | | | |

| LUMBAR | CODE | DESCRIPTION | PRICE |
|--------|-----------|----------------------------------|--------------|
| | NL | No Lumbar | +\$0 |
| | BL | Black Adjustable Lumbar | +\$30 |
| | BY | Bullseye Adjustable Lumbar | +\$30 |
| | DW | Designer White Adjustable Lumbar | +\$30 |
| | MR | Ember Adjustable Lumbar | +\$30 |
| | IR | Iris Adjustable Lumbar | +\$30 |
| | KT | Krypton Adjustable Lumbar | +\$30 |
| | RE | Regatta Adjustable Lumbar | +\$30 |
| | TL | Titanium Adjustable Lumbar | +\$30 |

**Adjustable Lumbar not available on CAL 133 (FC) models*

IGNITION® 2.0 Options

BASE



| CODE | DESCRIPTION | PRICE |
|-----------|---------------|-------------|
| SB | Standard Base | +\$0 |

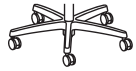

| | | |
|-----------|-------------------|---------------|
| PA | Polished Aluminum | +\$110 |
|-----------|-------------------|---------------|

FRAME

| CODE | DESCRIPTION | PRICE |
|------------|----------------|--------------|
| T | Black Frame | +\$0 |
| DWX | Designer White | +\$35 |
| TI | Titanium Frame | +\$35 |

BACK STYLE

| CODE | DESCRIPTION | PRICE |
|------|-------------|-------|
|------|-------------|-------|

4-Way Stretch mesh back options:

| | | |
|-----------|------------|-------------|
| IM | Black | +\$0 |
| IB | Breeze | +\$0 |
| IK | Brownstone | +\$0 |
| IC | Charcoal | +\$0 |
| IF | Fog | +\$0 |
| IR | Regatta | +\$0 |
| IT | Titanium | +\$0 |

ReActiv® back options:

| | | |
|------------|----------------|-------------|
| OS | Charcoal | +\$0 |
| DWR | Designer White | +\$0 |
| TI | Titanium | +\$0 |

IGNITION® 2.0

Dimensions

TASK DIMENSIONS

| MODEL | | HIWMM, HIWMRA, HIWMU, & HIWMUL | HIWMMHR | HIWMS | HITLM & HITLRA | HITSM & HITSRA |
|-------------------------|-------|-----------------------------------|-----------|-----------|----------------|----------------|
| Overall Width Armless | | 21 | 21 | 21 | 20 | 20 |
| Overall Width with Arms | A | 27 | 27 | 27 | 26 | 26 |
| Overall Depth | | 24 | 24 | 24 | 22 | 22 |
| Overall Height | S0/S1 | - | - | - | - | 52½ |
| | Y0/Y1 | 43¾ | 54 | 43¾ | 40½ | - |
| | S2 | - | - | 44½ | - | - |
| | Y2 | 44½ | 55 | - | 41¼ | - |
| | Y3 | 44½ | 55 | - | 41¼ | - |
| | Y4 | - | - | - | - | - |
| | W2 | 44½ | 55 | 44½ | 41¼ | - |
| Seat Width | | 20 | 20 | 20 | 18½ | 18½ |
| Seat Depth | | 18⅝ | 18⅝ | 18⅝ | 17⅝ | 17⅝ |
| Usable Seat Depth | S0 | - | - | - | - | 16¾ |
| | S1 | - | - | - | - | 15½ - 16⅞ |
| | S2 | - | - | 16½ - 18¼ | - | - |
| | Y0 | 17¾ | 17¾ | 17½ | 16¾ | - |
| | Y1 | 17½ - 19½ | 17½ - 19½ | 16¾ - 18¼ | 15½ - 17½ | - |
| | Y2 | 16¼ - 19¼ | 16¼ - 19¼ | - | 15¾ - 18½ | - |
| | Y3 | 16½ - 19½ | 16½ - 19½ | - | 16¼ - 18¾ | - |
| | Y4 | - | - | - | - | - |
| | W2 | 16¼ - 18½ | 16¼ - 18½ | 16¾ - 18¼ | 15¾ - 17¾ | - |
| Seat Height | S0/S1 | - | - | - | - | 22⅞ - 31¾ |
| | S2 | - | - | 17½ - 22¼ | - | - |
| | Y0/Y1 | 16⅝ - 21¼ | 16⅝ - 21¼ | 16¾ - 21½ | 16¾ - 21¼ | - |
| | Y2 | 17⅞ - 21½ | 17⅞ - 21½ | - | 17⅞ - 21½ | - |
| | Y3 | 17½ - 21½ | 17½ - 21½ | - | 17¾ - 21¾ | - |
| | Y4 | - | - | - | - | - |
| | W2 | 17⅞ - 21½ | 17⅞ - 21½ | 17 - 21½ | 17⅞ - 21½ | - |
| Back Width | | 19 | 19 | 19 | 19 | 17½ |
| Back Height | | 23 | 23 | 23 | 19 | 19 |
| Ship Weight Armless | S0 | - | - | - | - | 44 Ⓢ |
| | S1 | - | - | - | - | 46 Ⓢ |
| | S2 | - | - | 42 Ⓢ | - | - |
| | Y0 | 38 Ⓢ | 38 Ⓢ | 38 Ⓢ | 38 Ⓢ | - |
| | Y1 | 38 Ⓢ | 38 Ⓢ | 38 Ⓢ | 38 Ⓢ | - |
| | Y2 | 42 Ⓢ | 42 Ⓢ | - | 42 Ⓢ | - |
| | Y3 | 46 Ⓢ | 46 Ⓢ | - | 45 Ⓢ | - |
| | Y4 | - | - | - | - | - |
| | W2 | 42 Ⓢ | 42 Ⓢ | 42 Ⓢ | 42 Ⓢ | - |
| Ship Weight with Arms | S0 | - | - | - | - | 51 Ⓢ |
| | S1 | - | - | - | - | 53 Ⓢ |
| | S2 | - | - | 49 Ⓢ | - | - |
| | Y0 | 45 Ⓢ | 45 Ⓢ | 45 Ⓢ | 45 Ⓢ | - |
| | Y1 | 45 Ⓢ | 45 Ⓢ | 45 Ⓢ | 45 Ⓢ | - |
| | Y2 | 49 Ⓢ | 49 Ⓢ | - | 49 Ⓢ | - |
| | Y3 | 53 Ⓢ | 53 Ⓢ | - | 52 Ⓢ | - |
| | Y4 | - | - | - | - | - |
| | W2 | 49 Ⓢ | 49 Ⓢ | 49 Ⓢ | 49 Ⓢ | - |
| Width Between Arms | F | 20¼ | 20¼ | 20¾ | 19 | 19 |
| | P | 20¼ | 20¼ | 20¾ | 19 | 19 |
| | A | 18 - 20½ | 18 - 20½ | 17½ - 21 | 17 - 19½ | 17 - 19½ |
| | V | 12½ - 27½ | 12½ - 27½ | 12 - 27 | 11½ - 26½ | 11½ - 26⅝ |
| Cube | | 10.8 | 10.8 | 10.8 | 10.8 | 10.8 |
| Cube with Y3 Control | | 12 | 12 | - | 12 | - |
| COM | | 1.0 | 1.0 | - | 1.0 | 1.0 |
| Weight Capacity | | 300 lbs | 300 lbs | 300 lbs | 300 lbs | 300 lbs |

IGNITION® 2.0

Dimensions

TASK DIMENSIONS

| MODEL | HITLMKD & HITLRAKD | HIWMMKD, HIWMRAKD, HIWUMKD, & HIWMULKD | HIWMMSKD | HIWMBT |
|-------------------------|--------------------|---|-----------|------------------|
| Overall Width Armless | 20 | 21 | 21 | 30 |
| Overall Width with Arms | A 26 | 27 | 27 | 30 |
| Overall Depth | 22 | 24 | 24 | 30 |
| Overall Height | S0/S1 - | - | - | - |
| | Y0/Y1 40½ | 43¾ | 43¾ | - |
| | S2 - | - | 44½ | - |
| | Y2 - | - | - | - |
| | Y3 - | - | - | - |
| | Y4 - | - | - | 46 (+10½ for HR) |
| | W2 41¼ | 44½ | 44½ | - |
| Seat Width | 18½ | 20 | 20 | 23½ |
| Seat Depth | 17¾ | 18¾ | 18¾ | 20¼ |
| Usable Seat Depth | S0 - | - | - | - |
| | S1 - | - | - | - |
| | S2 - | - | 16½ - 18¼ | - |
| | Y0 16¾ | 17¾ | - | - |
| | Y1 15½ - 17½ | 17½ - 19½ | 16¾ - 18¼ | - |
| | Y2 - | - | - | - |
| | Y3 - | - | - | - |
| | Y4 - | - | - | 17¾ - 19½ |
| | W2 15¾ - 17¾ | 16¼ - 18½ | 16¾ - 18¼ | - |
| Seat Height | S0/S1 - | - | - | - |
| | S2 - | - | 17½ - 22¼ | - |
| | Y0/Y1 16¾ - 21¼ | 16¾ - 21¼ | 16¾ - 21½ | - |
| | Y2 - | - | - | - |
| | Y3 - | - | - | - |
| | Y4 - | - | - | 17 - 21½ |
| | W2 17½ - 21½ | 17½ - 21½ | 17 - 21½ | - |
| Back Width | 17½ | 19 | 19 | 22¾ |
| Back Height | 19 | 23 | 23 | 24¾ |
| Ship Weight Armless | S0 - | - | - | - |
| | S1 - | - | - | - |
| | S2 - | - | 42 Ⓢ | - |
| | Y0 38 Ⓢ | 38 Ⓢ | - | - |
| | Y1 38 Ⓢ | 38 Ⓢ | 38 Ⓢ | - |
| | Y2 - | - | - | - |
| | Y3 - | - | - | - |
| | Y4 - | - | - | 68 |
| | W2 42 Ⓢ | 42 Ⓢ | 42 Ⓢ | - |
| Ship Weight with Arms | S0 - | - | - | - |
| | S1 - | - | - | - |
| | S2 - | - | 49 Ⓢ | - |
| | Y0 45 Ⓢ | 45 Ⓢ | - | - |
| | Y1 45 Ⓢ | 45 Ⓢ | 45 Ⓢ | - |
| | Y2 - | - | - | - |
| | Y3 - | - | - | - |
| | Y4 - | - | - | 75 |
| | W2 49 Ⓢ | 49 Ⓢ | 49 Ⓢ | - |
| Width Between Arms | F 19 | 20¼ | 20¼ | - |
| | P 19 | 20¼ | 20¼ | - |
| | A 17 - 19½ | 18 - 20½ | 18 - 20½ | - |
| | V 11½ - 26½ | 12½ - 27½ | 12½ - 27½ | 14 - 29 |
| Cube | 5.6 | 6.3 | 10.8 | 15.3 |
| Cube with Y3 Control | - | - | - | - |
| COM | - | - | - | 1.5 |
| Weight Capacity | 300 lbs | 300 lbs | 300 lbs | 450 lbs |

IGNITION® 2.0



Icon Legend on page 17

HITLM

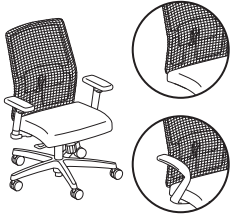

TASK LOW-BACK

- 4-Way Stretch Mesh Back
- Pneumatic
- Swivel
- Synchro-tilt
- Tilt Tension
- Tilt Lock
- Optional Lumbar Support

DIMENSIONS

| | | | |
|--------------|-----|--------------------|----------|
| Depth: | 22 | Width (with arms): | 26 |
| Height: | 40½ | Width (armless): | 20 |
| Seat Depth: | 16 | Cube: | 10.8 |
| Seat Width: | 18½ | COM: | 1.0 |
| Back Width: | 17½ | Weight Rating: | 300 lbs. |
| Back Height: | 19 | | |

FABRIC PRICE CODES

| | | | |
|---|-------|----|-------|
| 1 | \$532 | 8 | \$670 |
| 2 | \$556 | 9 | \$688 |
| 3 | \$580 | 10 | \$706 |
| 4 | \$598 | 11 | \$724 |
| 5 | \$616 | 12 | \$742 |
| 6 | \$634 | L | \$732 |
| 7 | \$652 | | |

See page 332 for additional specifications and dimensions.

HIWMM

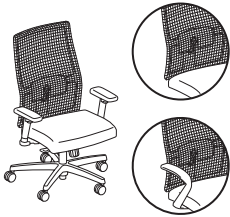

TASK MID-BACK

- 4-Way Stretch Mesh Back
- Pneumatic
- Swivel
- Synchro-tilt
- Tilt Tension
- Tilt Lock
- Optional Lumbar Support

DIMENSIONS

| | | | |
|--------------|-----|--------------------|----------|
| Depth: | 24 | Width (with arms): | 27 |
| Height: | 43¾ | Width (armless): | 21 |
| Seat Depth: | 17¾ | Cube: | 10.8 |
| Seat Width: | 20 | COM: | 1.0 |
| Back Width: | 19 | Weight Rating: | 300 lbs. |
| Back Height: | 23 | | |

FABRIC PRICE CODES

| | | | |
|---|-------|----|-------|
| 1 | \$583 | 8 | \$721 |
| 2 | \$607 | 9 | \$739 |
| 3 | \$631 | 10 | \$757 |
| 4 | \$649 | 11 | \$775 |
| 5 | \$667 | 12 | \$793 |
| 6 | \$685 | L | \$783 |
| 7 | \$703 | | |

See page 332 for additional specifications and dimensions.

HITSM



TASK LOW-BACK STOOL

- 4-Way Stretch Mesh Back
- Pneumatic
- Swivel
- Synchro-tilt
- Tilt Tension
- Tilt Lock
- Optional Lumbar Support

DIMENSIONS

| | | | |
|--------------|-----|--------------------|----------|
| Depth: | 22 | Width (with arms): | 26 |
| Height: | 52½ | Width (armless): | 20 |
| Seat Depth: | 16 | Cube: | 10.8 |
| Seat Width: | 18½ | COM: | 1.0 |
| Back Width: | 17½ | Weight Rating: | 300 lbs. |
| Back Height: | 19 | | |

FABRIC PRICE CODES

| | | | |
|---|-------|----|-------|
| 1 | \$637 | 8 | \$775 |
| 2 | \$661 | 9 | \$793 |
| 3 | \$685 | 10 | \$811 |
| 4 | \$703 | 11 | \$829 |
| 5 | \$721 | 12 | \$847 |
| 6 | \$739 | L | \$837 |
| 7 | \$757 | | |

See page 332 for additional specifications and dimensions.
 Not available in Polished Aluminum Base.

HON Recommendation: HIWMM.Y2.A.H.IM.CU__BL.SB.T - List Price \$763

HOW TO SPECIFY

| Select Model Number | Select Control Type | Select Arm Type | Select Caster | Select Mesh | Select Fabric | Select Lumbar | Select Base | Select Frame |
|---|---|--|----------------------|--------------|---|---------------------------------------|--|--------------|
| Y0 Synchro-Tilt | N Armless | H Black Hard | IM Black | See page 351 | NL No Lumbar | SB Standard Base | T Black | |
| Y1 Synchro-Tilt w/ Seat Slider (+ \$20) | A Height and Width Adjustable Arms (+ \$85) | S Black All-Surface Caster (+ \$40) | IB Breeze | | BL Black Adjustable Lumbar (+ \$30) | PA Polished Aluminum (+ \$110) | DWX Designer White (+ \$35 for HITLM and HIWMM; + \$55 for HITSM) | |
| Y2 Advanced Synchro-Tilt (+ \$65) | V All-Adjustable Arms (includes pivot) (+ \$130) | TS Titanium All-Surface Caster (+ \$40) | IK Brownstone | | BY Bullseye Adjustable Lumbar (+ \$30) | | TI Titanium (+ \$35 for HITLM and HIWMM; + \$55 for HITSM) | |
| Y3 Synchro-Tilt with Independent Back Angle (+ \$105) | F Fixed Arms (+ \$65) | R Black Roll Control Caster (+ \$50) | IC Charcoal | | DW Designer White Adjustable Lumbar (+ \$30) | | | |
| W2 Weight-Activated Synchro-Tilt w/ Seat Slider (+ \$65) | P Fixed Arms - Polished (+ \$175) | | IF Fog | | MR Ember Adjustable Lumbar (+ \$30) | | | |
| S0 Limited Recline Synchro-Tilt (for HITSM only) | | | IR Regatta | | IR Iris Adjustable Lumbar (+ \$30) | | | |
| S1 Limited Recline Synchro-Tilt w/ Seat Slider (+ \$20 for HITSM only) | | | IT Titanium | | KT Krypton Adjustable Lumbar (+ \$30) | | | |
| | | | | | RE Regatta Adjustable Lumbar (+ \$30) | | | |
| | | | | | TL Titanium Adjustable Lumbar (+ \$30) | | | |

HITLM . Y2 . A . H . IM . CU10 . BL . SB . T



Icon Legend on page 17

IGNITION® 2.0

HIWMMHR



TASK MID-BACK

- 4-Way Stretch Mesh Back w/ Headrest**
- Pneumatic
- Swivel
- Synchro-tilt
- Tilt Tension
- Tilt Lock
- Optional Lumbar Support
- Headrest

DIMENSIONS

| | | | |
|--------------|-----|--------------------|----------|
| Depth: | 24 | Width (with arms): | 27 |
| Height: | 54 | Width (armless): | 21 |
| Seat Depth: | 17¾ | Cube: | 10.8 |
| Seat Width: | 20 | COM: | 1.0 |
| Back Width: | 19 | Weight Rating: | 300 lbs. |
| Back Height: | 23 | | |

FABRIC PRICE CODES

| | | | |
|----------|--------------|-----------|--------------|
| 1 | \$583 | 8 | \$721 |
| 2 | \$607 | 9 | \$739 |
| 3 | \$631 | 10 | \$757 |
| 4 | \$649 | 11 | \$775 |
| 5 | \$667 | 12 | \$793 |
| 6 | \$685 | L | \$783 |
| 7 | \$703 | | |

❗ See page 332 for additional specifications and dimensions.

HON Recommendation: HIWMMHR.Y2.A.TS.IF.CU__DW.SB.DWX.HR - List Price \$918

HOW TO SPECIFY

| Select Model Number | Select Control Type | Select Arm Type | Select Caster | Select Mesh | Select Fabric | Select Lumbar | Select Base | Select Frame | Select Headrest |
|---|---|--|----------------------|--------------|---|---------------------------------------|------------------------------------|---|-----------------|
| YO Synchro-Tilt | N Armless | H Black Hard Caster | IM Black | See page 351 | NL No Lumbar | SB Standard Base | T Black | HR Headrest (+ \$80) | |
| Y1 Synchro-Tilt w/ Seat Slider (+ \$20) | A Height and Width Adjustable Arms (+ \$85) | S Black All-Surface Caster (+ \$40) | IB Breeze | | BL Black Adjustable Lumbar (+ \$30) | PA Polished Aluminum (+ \$110) | DWX Designer White (+ \$35) | <i>Headrest color will match chair frame selection. Headrest mesh color will match mesh back color selection.</i> | |
| Y2 Advanced Synchro-Tilt (+ \$65) | V All-Adjustable Arms (includes pivot) (+ \$130) | TS Titanium All-Surface Caster (+ \$40) | IK Brownstone | | BY Bullseye Adjustable Lumbar (+ \$30) | | TI Titanium (+ \$35) | | |
| Y3 Synchro-Tilt with Independent Back Angle (+ \$105) | F Fixed Arms (+ \$65) | R Black Roll Control Caster (+ \$50) | IC Charcoal | | DW Designer White Adjustable Lumbar (+ \$30) | | | | |
| W2 Weight-Activated Synchro-Tilt w/ Seat Slider (+ \$65) | P Fixed Arms - Polished (+ \$175) | | IF Fog | | MR Ember Adjustable Lumbar (+ \$30) | | | | |
| | | | IR Regatta | | IR Iris Adjustable Lumbar (+ \$30) | | | | |
| | | | IT Titanium | | KT Krypton Adjustable Lumbar (+ \$30) | | | | |
| | | | | | RE Regatta Adjustable Lumbar (+ \$30) | | | | |
| | | | | | TL Titanium Adjustable Lumbar (+ \$30) | | | | |
| | | | | | | | | | |

SEATING

IGNITION® 2.0



Icon Legend on page 17

HITLMKD



TASK LOW-BACK

4-Way Stretch Mesh Back
 Pneumatic
 Swivel
 Synchro-tilt
 Tilt Tension
 Tilt Lock
 Optional Lumbar Support

DIMENSIONS

| | | | |
|-------------|-----|--------------------|----------|
| Depth: | 22 | Back Height: | 19 |
| Height: | 40½ | Width (with arms): | 26 |
| Seat Depth: | 16 | Width (armless): | 20 |
| Seat Width: | 18½ | Cube: | 5.6 |
| Back Width: | 17½ | Weight Rating: | 300 lbs. |

FABRIC PRICE CODES

| | |
|----------|--------------|
| 1 | \$492 |
| 2 | \$516 |
| 3 | \$540 |

! See page 332 for additional specifications and dimensions.

HIWMMKD



TASK MID-BACK

4-Way Stretch Mesh Back
 Pneumatic
 Swivel
 Synchro-tilt
 Tilt Tension
 Tilt Lock
 Optional Lumbar Support

DIMENSIONS

| | | | |
|-------------|-----|--------------------|----------|
| Depth: | 24 | Back Height: | 23 |
| Height: | 43¾ | Width (with arms): | 27 |
| Seat Depth: | 17¾ | Width (armless): | 21 |
| Seat Width: | 20 | Cube: | 6.3 |
| Back Width: | 19 | Weight Rating: | 300 lbs. |

FABRIC PRICE CODES

| | |
|----------|--------------|
| 1 | \$543 |
| 2 | \$567 |
| 3 | \$591 |

! See page 332 for additional specifications and dimensions.

HON Recommendation: HIWMMKD.Y2.A.H.IM.CU__BL.SB.T - List Price \$723

HOW TO SPECIFY

| Select Model Number | Select Control Type | Select Arm Type | Select Caster | Select Mesh | Select Fabric | Select Lumbar | Select Base | Select Frame |
|---------------------|---|--|----------------------------|--|---------------|---|-------------------------|---|
| | Y1 Synchro-Tilt w/ Seat Slider (+ \$20) Y2 Advanced Synchro-Tilt (+ \$65) W2 Weight-Activated Synchro-Tilt w/ Seat Slider (+ \$65) | A Height and Width Adjustable Arms (+ \$85) | H Black Hard Caster | IM Black IF Fog IC Charcoal | See page 351 | NL No Lumbar BL Black Adjustable Lumbar (+ \$30) BY Bullseye Adjustable Lumbar (+ \$30) DW Designer White Adjustable Lumbar (+ \$30) MR Ember Adjustable Lumbar (+ \$30) IR Iris Adjustable Lumbar (+ \$30) KT Krypton Adjustable Lumbar (+ \$30) RE Regatta Adjustable Lumbar (+ \$30) TL Titanium Adjustable Lumbar (+ \$30) | SB Standard Base | T Black DWX Designer White (+ \$35) TI Titanium (+ \$35) |
| H I W M M K D . | Y 2 . | A . | H . | I M . | C U 1 0 . | B L . | S B . | T |



Icon Legend on page 17

IGNITION® 2.0

HIWMBT



TASK MID-BACK

- 4-Way Stretch Mesh Back**
- Pneumatic
- Swivel
- Synchro-tilt
- Tilt Tension
- Tilt Lock
- Optional Lumbar Support

DIMENSIONS

| | | | |
|--------------|-----|--------------------|----------|
| Depth: | 30 | Width (with arms): | 30 |
| Height: | 47 | Width (armless): | 30 |
| Seat Depth: | 20¼ | Cube: | 15.3 |
| Seat Width: | 23½ | COM: | 1.5 |
| Back Width: | 22¾ | Weight Rating: | 450 lbs. |
| Back Height: | 24¾ | | |

FABRIC PRICE CODES

| | | | |
|----------|---------------|-----------|---------------|
| 1 | \$982 | 8 | \$1120 |
| 2 | \$1006 | 9 | \$1138 |
| 3 | \$1030 | 10 | \$1156 |
| 4 | \$1048 | 11 | \$1174 |
| 5 | \$1066 | 12 | \$1192 |
| 6 | \$1084 | L | \$1182 |
| 7 | \$1102 | | |

❗ See page 332 for additional specifications and dimensions.

HON Recommendation: HIWMBT.Y4.V.A.IC.CU__TL.SB.TI.N - List Price \$1177

HOW TO SPECIFY

| Select Model Number | Select Control Type | Select Arm Type | Select Caster | Select Mesh | Select Fabric | Select Lumbar | Select Base | Select Frame | Select Headrest |
|---------------------|------------------------|---|-----------------------------|--|---------------|---|-------------------------|---|---|
| | Y4 Synchro-Tilt | V All-Adjustable Arms (includes pivot) (+ \$130) N Armless | A All-Surface Caster | IM Black IF Fog IC Charcoal | See page 351 | NL No Lumbar BL Black Adjustable Lumbar (+ \$30) BY Bullseye Adjustable Lumbar (+ \$30) DW Designer White Adjustable Lumbar (+ \$30) MR Ember Adjustable Lumbar (+ \$30) IR Iris Adjustable Lumbar (+ \$30) KT Krypton Adjustable Lumbar (+ \$30) RE Regatta Adjustable Lumbar (+ \$30) TL Titanium Adjustable Lumbar (+ \$30) | SB Standard Base | T Black DWX Designer White (+ \$35) TI Titanium (+ \$35) | N No Headrest HR Headrest (+ \$80) <i>Big & Tall headrest frame is black. Mesh color matches mesh back selection.</i> |
| HIWMBT | Y4 | V | A | IM | CU10 | BL | SB | T | HR |

SEATING

IGNITION® 2.0

OPEN MARKET



Icon Legend on page 17

HIWMMS



TASK MID-BACK

4-Way Stretch Mesh Back and Seat

- Pneumatic
- Swivel
- Synchro-tilt
- Tilt Tension
- Tilt Lock
- Optional Lumbar Support
- Optional Headrest

DIMENSIONS

| | | | |
|--------------|-----|--------------------|----------|
| Depth: | 24 | Width (with arms): | 27 |
| Height: | 43¾ | Width (armless): | 21 |
| Seat Depth: | 17¾ | Cube: | 10.8 |
| Seat Width: | 20 | Weight Rating: | 300 lbs. |
| Back Width: | 19 | | |
| Back Height: | 23 | | |

LIST PRICE

\$681

! See page 332 for additional specifications and dimensions.

HIWMMSKD



TASK MID-BACK

4-Way Stretch Mesh Back and Seat

- Pneumatic
- Swivel
- Synchro-tilt
- Tilt Tension
- Tilt Lock
- Optional Lumbar Support
- Optional Headrest

DIMENSIONS

| | | | |
|--------------|-----|--------------------|----------|
| Depth: | 24 | Width (with arms): | 27 |
| Height: | 43¾ | Width (armless): | 21 |
| Seat Depth: | 17¾ | Cube: | 7.9 |
| Seat Width: | 20 | Weight Rating: | 300 lbs. |
| Back Width: | 19 | | |
| Back Height: | 23 | | |

LIST PRICE

\$641

! See page 332 for all other control specifications.

HON Recommendation: HIWMMS.W2.A.H.IM.IMS.BL.SB.T.N - List Price \$861

HOW TO SPECIFY

| Select Model Number | Select Control Type | Select Arm Type | Select Caster | Select Back Mesh | Select Seat Mesh | Select Lumbar | Select Base | Select Frame | Select Headrest |
|---------------------|--|---|---|------------------|-----------------------|---|---|----------------|--|
| | Y0 Synchro-Tilt <i>Available on model HIWMMS only</i> Y1 Synchro-Tilt w/ Seat Slider (+ \$20) S2 Limited Recline Advanced Synchro-Tilt (+ \$65) W2 Weight-Activated Synchro-Tilt w/ Seat Slider (+ \$65) | N Armless A Height and Width Adjustable Arms (+ \$85) F Fixed Arms (+ \$65) V All-Adjustable Arms (+ \$130) P Fixed Polished Arms (+ \$175) <i>F, V, and P available on model HIWMMS only</i> | H Black Hard Caster S Black All-Surface Caster (+ \$40) <i>Available on model HIWMMS only</i> | IM Black | IMS Black Mesh | NL No Lumbar BL Black Adjustable Lumbar (+ \$30) BY Bullseye Adjustable Lumbar (+ \$30) DW Designer White Adjustable Lumbar (+ \$30) MR Ember Adjustable Lumbar (+ \$30) IR Iris Adjustable Lumbar (+ \$30) KT Krypton Adjustable Lumbar (+ \$30) RE Regatta Adjustable Lumbar (+ \$30) TL Titanium Adjustable Lumbar (+ \$30) | SB Standard Base PA Polished Aluminum (+ \$110) <i>Available on model HIWMMS only</i> | T Black | N No Headrest HR Headrest (+ \$80) <i>Headrest frame color will match chair frame selection. Headrest mesh color will match mesh back selection.</i> |
| HIWMMS | Y1 | A | H | IM | IMS | BL | SB | T | N |

SEATING



Icon Legend on page 17

IGNITION® 2.0 ReActiv®

HITLRA

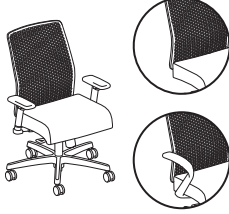

TASK LOW-BACK

- ReActiv® Back
- Pneumatic
- Swivel
- Synchro-tilt
- Tilt Tension
- Tilt Lock
- Optional Lumbar Support

DIMENSIONS

| | | | |
|--------------|-----|--------------------|----------|
| Depth: | 22 | Width (with arms): | 26 |
| Height: | 40½ | Width (armless): | 20 |
| Seat Depth: | 16 | Cube: | 10.8 |
| Seat Width: | 18½ | COM: | 1.0 |
| Back Width: | 17½ | Weight Rating: | 300 lbs. |
| Back Height: | 19 | | |

FABRIC PRICE CODES

| | | | |
|---|-------|----|-------|
| 1 | \$567 | 8 | \$705 |
| 2 | \$591 | 9 | \$723 |
| 3 | \$615 | 10 | \$741 |
| 4 | \$633 | 11 | \$759 |
| 5 | \$651 | 12 | \$777 |
| 6 | \$669 | L | \$767 |
| 7 | \$687 | | |

❗ See page 332 for all other control specifications.

HIWMRA

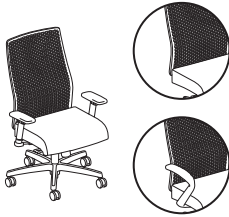

TASK MID-BACK

- ReActiv® Back
- Pneumatic
- Swivel
- Synchro-tilt
- Tilt Tension
- Tilt Lock
- Optional Lumbar Support

DIMENSIONS

| | | | |
|--------------|-----|--------------------|----------|
| Depth: | 24 | Width (with arms): | 27 |
| Height: | 43¾ | Width (armless): | 21 |
| Seat Depth: | 17¾ | Cube: | 10.8 |
| Seat Width: | 20 | COM: | 1.0 |
| Back Width: | 19 | Weight Rating: | 300 lbs. |
| Back Height: | 23 | | |

FABRIC PRICE CODES

| | | | |
|---|-------|----|-------|
| 1 | \$618 | 8 | \$756 |
| 2 | \$642 | 9 | \$774 |
| 3 | \$666 | 10 | \$792 |
| 4 | \$684 | 11 | \$810 |
| 5 | \$702 | 12 | \$828 |
| 6 | \$720 | L | \$818 |
| 7 | \$738 | | |

❗ See page 332 for all other control specifications.

HITSRA

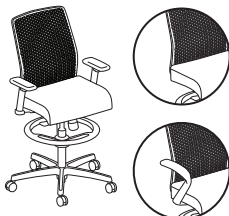

TASK LOW-BACK STOOL

- ReActiv® Back
- Pneumatic
- Swivel
- Synchro-tilt
- Tilt Tension
- Tilt Lock
- Optional Lumbar Support

DIMENSIONS

| | | | |
|--------------|-----|--------------------|----------|
| Depth: | 22 | Width (with arms): | 26 |
| Height: | 52½ | Width (armless): | 20 |
| Seat Depth: | 16 | Cube: | 10.8 |
| Seat Width: | 18½ | COM: | 1.0 |
| Back Width: | 17½ | Weight Rating: | 300 lbs. |
| Back Height: | 19 | | |

FABRIC PRICE CODES

| | | | |
|---|-------|----|-------|
| 1 | \$672 | 8 | \$810 |
| 2 | \$696 | 9 | \$828 |
| 3 | \$720 | 10 | \$846 |
| 4 | \$738 | 11 | \$864 |
| 5 | \$756 | 12 | \$882 |
| 6 | \$774 | L | \$872 |
| 7 | \$792 | | |

❗ See page 332 for all other control specifications.

❗ Not available in Polished Aluminum Base.

HON Recommendation: HIWMRA.Y2.A.H.___CU__BL.SB.T - List Price \$798

HOW TO SPECIFY

| Select Model Number | Select Control Type | Select Arm Type | Select Caster | Select Back Color | Select Fabric | Select Lumbar | Select Base | Select Frame |
|--|---|--|-----------------------------|-------------------|---|---------------------------------------|---|--------------|
| Y0 Synchro-Tilt | N Armless | H Black Hard Caster | OS Charcoal ReActiv® | See page 351 | NL No Lumbar | SB Standard Base | T Black | |
| Y1 Synchro-Tilt w/ Seat Slider (+ \$20) | A Height and Width Adjustable Arms (+ \$85) | S Black All-Surface Caster (+ \$40) | DWR Designer White | | BL Black Adjustable Lumbar (+ \$30) | PA Polished Aluminum (+ \$110) | DWX Designer White (+ \$35 for HITLRA and HIWMRA; + \$55 for HITSRA) | |
| Y2 Advanced Synchro-Tilt (+ \$65) | V All-Adjustable Arms (includes pivot) (+ \$130) | TS Titanium All-Surface Caster (+ \$40) | TI Titanium ReActiv® | | BY Bullseye Adjustable Lumbar (+ \$30) | | TI Titanium (+ \$35 for HITLRA and HIWMRA; + \$55 for HITSRA) | |
| Y3 Synchro-Tilt with Independent Back Angle (+ \$105) | F Fixed Arms (+ \$65) | R Black Roll Control Caster (+ \$50) | | | DW Designer White Adjustable Lumbar (+ \$30) | | | |
| W2 Weight-Activated Synchro-Tilt w/ Seat Slider (+ \$65) | P Fixed Arms - Polished (+ \$175) | | | | MR Ember Adjustable Lumbar (+ \$30) | | | |
| S0 Limited Synchro-Tilt (for HITSRA only) | | | | | IR Iris Adjustable Lumbar (+ \$30) | | | |
| S1 Limited Synchro-Tilt w/ Seat Slider (+ \$20 for HITSRA only) | | | | | KT Krypton Adjustable Lumbar (+ \$30) | | | |
| <i>Specify S0 or S1 for HITSRA model ONLY</i> | | | | | RE Regatta Adjustable Lumbar (+ \$30) | | | |
| | | | | | TL Titanium Adjustable Lumbar (+ \$30) | | | |

HITLRA - Y2 - A - H - OS - CU10 - BL - SB - T

IGNITION® 2.0 ReActiv®

OPEN MARKET



Icon Legend on page 17

HITLRAKD

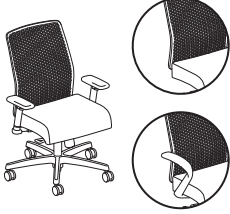

TASK LOW-BACK

ReActiv® Back
Pneumatic
Swivel
Synchro-tilt
Tilt Tension
Tilt Lock
Optional Lumbar Support

DIMENSIONS

Depth: 22
Height: 40½
Seat Depth: 16
Seat Width: 18½
Back Width: 17½
Back Height: 25½
Width (with arms): 26
Width (armless): 20
Cube: 5.6
Weight Rating: 300 lbs.

FABRIC PRICE CODES

1 \$527
2 \$551
3 \$575

! See page 332 for all other control specifications.

HIWMRAKD

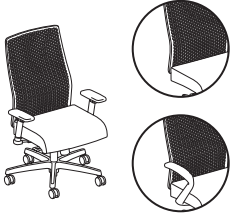

TASK MID-BACK

ReActiv® Back
Pneumatic
Swivel
Synchro-tilt
Tilt Tension
Tilt Lock
Optional Lumbar Support

DIMENSIONS

Depth: 24
Height: 43¾
Seat Depth: 17¾
Seat Width: 20
Back Width: 19
Back Height: 29
Width (with arms): 27
Width (armless): 21
Cube: 6.3
Weight Rating: 300 lbs.

FABRIC PRICE CODES

1 \$578
2 \$602
3 \$626

! See page 332 for all other control specifications.

HON Recommendation: HIWMRAKD.Y2.A.H.__CU__BL.SB.T - List Price \$758

SEATING

HOW TO SPECIFY

| Select Model Number | Select Control Type | Select Arm Type | Select Caster | Select Back Color | Select Fabric | Select Lumbar | Select Base | Select Frame |
|---------------------|---|--|----------------------------|--|---------------|---|-------------------------|---|
| | Y1 Synchro-Tilt w/ Seat Slider (+ \$20) Y2 Advanced Synchro-Tilt (+ \$65) W2 Weight-Activated Synchro-Tilt w/ Seat Slider (+ \$65) | N Armless A Height and Width Adjustable Arms (+ \$85) | H Black Hard Caster | OS Charcoal ReActiv® DWR Designer White ReActiv® TI Titanium ReActiv® | See page 351 | NL No Lumbar BL Black Adjustable Lumbar (+ \$30) BY Bullseye Adjustable Lumbar (+ \$30) DW Designer White Adjustable Lumbar (+ \$30) MR Ember Adjustable Lumbar (+ \$30) IR Iris Adjustable Lumbar (+ \$30) KT Krypton Adjustable Lumbar (+ \$30) RE Regatta Adjustable Lumbar (+ \$30) TL Titanium Adjustable Lumbar (+ \$30) | SB Standard Base | T Black DWX Designer White (+ \$35) TI Titanium (+ \$35) |
| H I W M R A K D . | Y 2 . | A . | H . | O S . | C U 1 0 . | B L . | S B . | T |



Icon Legend on page 17

IGNITION® 2.0 Upholstered

HIWMU



TASK MID-BACK

Upholstered Back

- Pneumatic
- Swivel
- Synchro-tilt
- Tilt Tension
- Tilt Lock

DIMENSIONS

| | | | |
|--------------|-----|--------------------|----------|
| Depth: | 24 | Width (with arms): | 27 |
| Height: | 43¾ | Width (armless): | 21 |
| Seat Depth: | 17¾ | Cube: | 10.8 |
| Seat Width: | 20 | COM: | 3.0 |
| Back Width: | 19 | Weight Rating: | 300 lbs. |
| Back Height: | 23 | | |

FABRIC PRICE CODES

| | | | |
|---|-------|----|--------|
| 1 | \$583 | 7 | \$883 |
| 2 | \$643 | 8 | \$928 |
| 3 | \$703 | 9 | \$973 |
| 4 | \$748 | 10 | \$1018 |
| 5 | \$793 | 11 | \$1063 |
| 6 | \$838 | 12 | \$1108 |

! See page 332 for additional specifications and dimensions.

HIWMUL

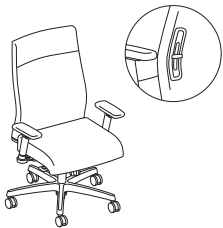

TASK MID-BACK WITH ADJUSTABLE LUMBAR

Upholstered Back

- Pneumatic
- Swivel
- Synchro-tilt
- Tilt Tension
- Tilt Lock
- Adjustable Lumbar

DIMENSIONS

| | | | |
|--------------|-----|--------------------|----------|
| Depth: | 24½ | Width (with arms): | 27 |
| Height: | 43¾ | Width (armless): | 21 |
| Seat Depth: | 17¾ | Cube: | 10.8 |
| Seat Width: | 20 | COM: | 3.0 |
| Back Width: | 19 | Weight Rating: | 300 lbs. |
| Back Height: | 23 | | |

FABRIC PRICE CODES

| | | | |
|---|-------|----|--------|
| 1 | \$616 | 7 | \$916 |
| 2 | \$676 | 8 | \$961 |
| 3 | \$736 | 9 | \$1006 |
| 4 | \$781 | 10 | \$1051 |
| 5 | \$826 | 11 | \$1096 |
| 6 | \$871 | 12 | \$1141 |

! See page 332 for additional specifications and dimensions.

HON Recommendation: HIWMU.Y2.A.H.CU__NL.SB.T - List Price \$733

HOW TO SPECIFY

| Select Model Number | Select Control Type | Select Arm Type | Select Caster | Select Fabric | Select Lumbar | Select Base | Select Frame |
|--|---|--|---------------------|--|---|--|--------------|
| <p>Y0 Synchro-Tilt</p> <p>Y1 Synchro-Tilt w/ Seat Slider (+ \$20)</p> <p>Y2 Advanced Synchro-Tilt (+ \$65)</p> <p>Y3 Synchro-Tilt with Independent Back Angle (+ \$105)</p> <p>W2 Weight-Activated Synchro-Tilt w/ Seat Slider (+ \$65)</p> | <p>N Armless</p> <p>A Height and Width Adjustable Arms (+ \$85)</p> <p>V All-Adjustable Arms (+ \$130)</p> <p>F Fixed Arms (+ \$65)</p> <p>P Fixed Arms - Polished (+ \$175)</p> | <p>H Black Hard Caster</p> <p>S Black All-Surface Caster (+ \$40)</p> <p>TS Titanium All-Surface Caster (+ \$40)</p> <p>R Black Roll Control Caster (+ \$50)</p> | <p>See page 351</p> | <p>NL No Lumbar</p> <p><i>Specify for model HIWMU only</i></p> <p>AL Adjustable Lumbar</p> <p><i>Specify for model HIWMUL only</i></p> | <p>SB Standard Base</p> <p>PA Polished Aluminum (+ \$110)</p> | <p>T Black</p> <p>DWX Designer White (+ \$35)</p> <p>TI Titanium (+ \$35)</p> | |
| HIWMU | Y2 | A | H | CU10 | NL | SB | T |

IGNITION® 2.0 Upholstered

GSA SIN 33721



Icon Legend on page 17

HIWMUKD



TASK MID-BACK

Upholstered Back
Pneumatic
Swivel
Synchro-tilt
Tilt Tension
Tilt Lock

DIMENSIONS

| | | | |
|-------------|-----|--------------------|----------|
| Depth: | 24 | Back Height: | 23 |
| Height: | 43¾ | Width (with arms): | 27 |
| Seat Depth: | 17¾ | Width (armless): | 21 |
| Seat Width: | 20 | Cube: | 6.3 |
| Back Width: | 19 | Weight Rating: | 300 lbs. |

FABRIC PRICE CODES

| | |
|----------|--------------|
| 1 | \$543 |
| 2 | \$603 |
| 3 | \$663 |

! See page 332 for additional specifications and dimensions.

HIWMULKD



TASK MID-BACK WITH ADJUSTABLE LUMBAR

Upholstered Back
Pneumatic
Swivel
Synchro-tilt
Tilt Tension
Tilt Lock
Adjustable Lumbar

DIMENSIONS

| | | | |
|-------------|-----|--------------------|----------|
| Depth: | 24½ | Back Height: | 23 |
| Height: | 43¾ | Width (with arms): | 27 |
| Seat Depth: | 17¾ | Width (armless): | 21 |
| Seat Width: | 20 | Cube: | 6.3 |
| Back Width: | 19 | Weight Rating: | 300 lbs. |

FABRIC PRICE CODES

| | |
|----------|--------------|
| 1 | \$576 |
| 2 | \$636 |
| 3 | \$696 |

! See page 332 for additional specifications and dimensions.

HON Recommendation: HIWMUKD.Y2.A.H.CU__NL.SB.T - List Price \$693

SEATING

HOW TO SPECIFY

| Select Model Number | Select Control Type | Select Arm Type | Select Caster | Select Fabric | Select Lumbar | Select Base | Select Frame |
|---------------------|--|---|----------------------------|---------------|--|-------------------------|--|
| HIWMUKD | <p>Y1 Synchro-Tilt w/ Seat Slider (+ \$20)</p> <p>Y2 Advanced Synchro-Tilt (+ \$65)</p> <p>W2 Weight-Activated Synchro-Tilt w/ Seat Slider (+ \$65)</p> | <p>N Armless</p> <p>A Height and Width Adjustable Arms (+ \$85)</p> | H Black Hard Caster | See page 351 | <p>NL No Lumbar <i>Specify for model HIWMUKD only</i></p> <p>AL Adjustable Lumbar <i>Specify for model HIWMULKD only</i></p> | SB Standard Base | <p>T Black</p> <p>DWX Designer White (+ \$35)</p> <p>TI Titanium (+ \$35)</p> |
| HIWMUKD | Y2 | A | H | CU10 | NL | SB | T |



Icon Legend on page 17

IGNITION® 2.0 Accessories

HI2ATA



ADJUSTABLE ARMS

Height and Width
Functions: **S**
(Function Key on pages 212-213)

DIMENSIONS

Adjustable Arms Width: 17-19½
Height from Seat: 8-11
Ship Weight: 8
Cube: 1.0

LIST PRICE

\$132

HI2AAA

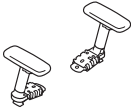

ALL-ADJUSTABLE ARMS

Height, Width, Depth and Pivot

DIMENSIONS

Adjustable Arms Width: 17-20
Height from Seat: 7-11
Ship Weight: 8
Cube: 1.0

LIST PRICE

\$178

HI2FHA



FIXED HEIGHT ARMS

DIMENSIONS

Arm Width: 20
Height from Seat: 9½
Ship Weight: 7
Cube: 1.0

LIST PRICE

\$122

HIPAA

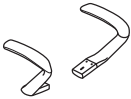

POLISHED ALUMINUM ARMS

Fixed Height

DIMENSIONS

Arm Width: 20
Height from Seat: 9½
Ship Weight: 10
Cube: 1.0

LIST PRICE

\$201

HILMBR

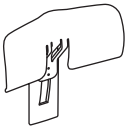

LUMBAR SUPPORT

DIMENSIONS

Ship Weight: 8
Cube: 1.0

LIST PRICE

\$35

HSCASTER

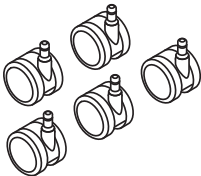

SET OF 5 ALL-SURFACE CASTERS

DIMENSIONS

Size: 60mm
Ship Weight: 2
Cube: 0.1

LIST PRICE

\$59

ⓘ Available in Black finish only, no specification needed.

OPEN MARKET

HOW TO SPECIFY

| | |
|---|--|
| <p>Select Model Number</p> <p>HI2ATA.</p> | <p>Select Frame</p> <p>T Black DWX Designer White TI Titanium</p> <p><i>Not specified for model HIPAA</i></p> <p>T</p> |
|---|--|

HOW TO SPECIFY

| | |
|---|--|
| <p>Select Model Number</p> <p>HILMBR.</p> | <p>Select Lumbar Color</p> <p>BL Black MR Ember RE Regatta BY Bullseye IR Iris TL Titanium DW Designer White KT Krypton</p> <p>BL</p> |
|---|--|

IGNITION® 2.0 Accessories

OPEN MARKET



Icon Legend on page 17

HI2HR

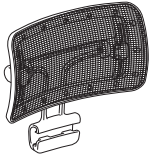

MESH HEADREST

DIMENSIONS

| | |
|--------------|-----|
| Mesh Width: | 12 |
| Mesh Height: | 6 |
| Ship Weight: | 3 |
| Cube: | 1.0 |

LIST PRICE

\$145

NOTES: Headrest is compatible with Ignition® mid-back mesh back models HIWMM, HIWMMKD, HIWMMMS, and HIWMMSKD purchased after July 2021.

HI2BTHR

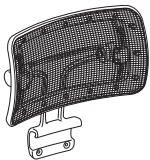

BIG & TALL MESH HEADREST

DIMENSIONS

| | |
|--------------|-----|
| Mesh Width: | 12 |
| Mesh Height: | 6 |
| Ship Weight: | 3 |
| Cube: | 1.0 |

LIST PRICE

\$153

NOTES: Headrest is compatible with Ignition® mid-back mesh back Big & Tall model HIWMBT.

HOW TO SPECIFY

| | | |
|--|---|--|
| Select Model Number <div style="border: 1px solid #ccc; padding: 2px; display: flex; gap: 5px;"> HI2HR </div> | Select Mesh IM Black IB Breeze IK Brownstone IC Charcoal IF Fog IR Regatta IT Titanium | Select Frame T Black DWX Designer White (+ \$35) TI Titanium (+ \$35) |
|--|---|--|

HOW TO SPECIFY

| | | |
|--|--|---------------------------------------|
| Select Model Number <div style="border: 1px solid #ccc; padding: 2px; display: flex; gap: 5px;"> HI2BTHR </div> | Select Mesh IM Black IC Charcoal IF Fog | Select Frame T Black |
|--|--|---------------------------------------|

SEATING

IGNITION® Multi-Purpose Chair Options

| ARM STYLE | CODE | DESCRIPTION | PRICE |
|-----------|----------|-------------|--------------|
| | N | Armless | +\$0 |
| | F | Fixed Arms | +\$30 |



| CASTERS/ GLIDE | CODE | DESCRIPTION | PRICE |
|-------------------|----------|--------------------------|--------------|
| | H | Black Hard Caster | +\$0 |
| | S | Black All-Surface Caster | +\$30 |
| | E | Glide | +\$0 |

Castors only available on HIGS6



| MESH STYLE | CODE | DESCRIPTION | PRICE |
|------------|-----------|-------------|-------------|
| | IM | Black | +\$0 |
| | IB | Breeze | +\$0 |
| | IK | Brownstone | +\$0 |
| | IC | Charcoal | +\$0 |
| | IF | Fog | +\$0 |
| | IR | Regatta | +\$0 |
| | IT | Titanium | +\$0 |
| | U | Upholstered | +\$0 |

| FRAME | CODE | DESCRIPTION | PRICE |
|-------|-------------|----------------------------|--------------|
| | T | Black | +\$0 |
| | BLCK | Textured Black Mica | +\$0 |
| | PK7 | Textured Designer White | +\$35 |
| | PLAT | Textured Platinum Metallic | +\$0 |
| | PR8T | Textured Silver | +\$35 |

By selecting PR8T, unit will be produced with titanium colored arm caps, back frame, & glides

By selecting PK7, unit will be produced with Designer White colored arm caps, back frame, & glides

By selecting PLAT, unit will be produced with black arm caps, black back frame, black glides, and platinum colored legs

Refer to Configurator on HON.com for visualization

IGNITION® Multi-Purpose

GSA SIN 33721



Icon Legend on page 17

HIGS6

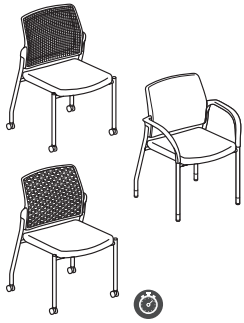

MULTI-PURPOSE

Four Legs

DIMENSIONS

| | | | |
|--------------|--------------------------------|---------------------------|--------------------------------|
| Depth: | 21 ³ / ₄ | Seat to Floor Height: | 18 ³ / ₈ |
| Width: | 25 | Usable Seat Depth: | 17 ³ / ₈ |
| Height: | 33 ¹ / ₂ | Ship Weight: | 28 |
| Seat Depth: | 17 ³ / ₈ | Cube: | 15.1 |
| Seat Width: | 18 ³ / ₄ | COM (upholstered back): | 1.5 |
| Back Width: | 18 ¹ / ₄ | COM (mesh/ReActiv® back): | 1.0 |
| Back Height: | 18 ¹ / ₈ | Weight Rating: | 300 lbs. |
| Arm Width: | 21 ¹ / ₂ | | |

FABRIC PRICE CODES

| | | | |
|----------|--------------|-----------|--------------|
| 1 | \$466 | 8 | \$673 |
| 2 | \$502 | 9 | \$700 |
| 3 | \$538 | 10 | \$727 |
| 4 | \$565 | 11 | \$754 |
| 5 | \$592 | 12 | \$781 |
| 6 | \$619 | L | \$766 |
| 7 | \$646 | | |

NOTES: Stacks 4-high.

- ! Ganging brackets work with armless Guest/Multi-purpose models only.
- ! ReActiv® back option not available on FC models.

HISB6

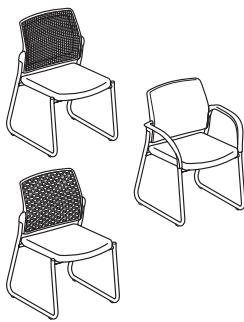

MULTI-PURPOSE

Sled Base

DIMENSIONS

| | | | |
|--------------|--------------------------------|---------------------------|--------------------------------|
| Depth: | 23 ³ / ₄ | Seat to Floor Height: | 18 ³ / ₈ |
| Width: | 25 | Usable Seat Depth: | 17 ³ / ₈ |
| Height: | 33 ¹ / ₂ | Ship Weight: | 30 |
| Seat Depth: | 17 ³ / ₈ | Cube: | 15.1 |
| Seat Width: | 18 ³ / ₄ | COM (upholstered back): | 1.5 |
| Back Width: | 18 ¹ / ₄ | COM (mesh/ReActiv® back): | 1.0 |
| Back Height: | 18 ¹ / ₈ | Weight Rating: | 300 lbs. |
| Arm Width: | 21 ¹ / ₂ | | |

FABRIC PRICE CODES

| | | | |
|----------|--------------|-----------|--------------|
| 1 | \$466 | 8 | \$673 |
| 2 | \$502 | 9 | \$700 |
| 3 | \$538 | 10 | \$727 |
| 4 | \$565 | 11 | \$754 |
| 5 | \$592 | 12 | \$781 |
| 6 | \$619 | L | \$766 |
| 7 | \$646 | | |

- ! Ganging brackets work with armless Guest/Multi-purpose models only.
- ! ReActiv® back option not available on FC models.

HICS7



CAFÉ-HEIGHT STOOL

Four Legs

DIMENSIONS

| | | | |
|--------------|--------------------------------|---------------------------|--------------------------------|
| Depth: | 23 | Seat to Floor Height: | 31 |
| Width: | 25 | Usable Seat Depth: | 17 ³ / ₈ |
| Height: | 46 ¹ / ₂ | Ship Weight: | 37 |
| Seat Depth: | 17 ³ / ₈ | Cube: | 21.8 |
| Seat Width: | 18 ³ / ₄ | COM (upholstered back): | 1.5 |
| Back Width: | 18 ¹ / ₄ | COM (mesh/ReActiv® back): | 1.0 |
| Back Height: | 18 ¹ / ₈ | Weight Rating: | 300 lbs. |
| Arm Width: | 21 ¹ / ₂ | | |

FABRIC PRICE CODES

| | | | |
|----------|--------------|-----------|--------------|
| 1 | \$588 | 8 | \$795 |
| 2 | \$624 | 9 | \$822 |
| 3 | \$660 | 10 | \$849 |
| 4 | \$687 | 11 | \$876 |
| 5 | \$714 | 12 | \$903 |
| 6 | \$741 | L | \$888 |
| 7 | \$768 | | |

- ! Ganging brackets work with armless Guest/Multi-purpose models only.
- ! ReActiv® back option not available on FC models.

HON Recommendation: HIGS6.F.H.IM.CU__T - List Price \$496

HOW TO SPECIFY

| | | | | | |
|---|--|---|---|--|---|
| Select Model Number (+ \$30) F Fixed Arms N Armless | Select Arm Type F Fixed Arms (+ \$30) N Armless | Select Glide E Glide H Black Hard Caster S Black All-Surface Caster (+ \$30) <i>Casters available on HIGS6 only</i> | Select Back Type IM Black IB Breeze IK Brownstone IC Charcoal OS Charcoal ReActiv® (+ \$30) DWR Designer White ReActiv® (+ \$30) | Select Fabric See page 351 IF Fog IR Regatta IT Titanium TI Titanium ReActiv® (+ \$30) U Upholstered | Select Frame T Black BLCK Textured Black Mica PK7 Textured Designer White (+ \$35) PLAT Textured Platinum Metallic PR8T Textured Silver (+ \$35) |
| H I G S 6 . | F . | H . | I M . | C U 1 0 . | T |



HIGS6DF

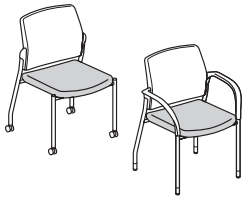

MULTI-PURPOSE

Multi-Fabric
Four Legs

DIMENSIONS

| | | | |
|--------------|--------------------------------|---------------------------------|--------------------------------|
| Depth: | 21 ³ / ₄ | Arm Width: | 21 ¹ / ₂ |
| Width: | 25 | Seat to Floor Height: | 18 ³ / ₈ |
| Height: | 33 ¹ / ₂ | Usable Seat Depth: | 17 ³ / ₈ |
| Seat Depth: | 17 ³ / ₈ | Ship Weight (upholstered back): | 28 |
| Seat Width: | 18 ³ / ₄ | Cube (upholstered back): | 15.1 |
| Back Width: | 18 ¹ / ₄ | COM (back): | 0.75 |
| Back Height: | 18 ¹ / ₈ | COM (seat): | 0.75 |
| | | Weight Rating: | 300 lbs. |

FABRIC PRICE CODES

| | | |
|--------------------------------|--------------|--------------|
| 1 | \$541 | |
| <i>Add to Base Price Above</i> | | |
| | Back | Seat |
| 2 | \$18 | \$18 |
| 3 | \$36 | \$36 |
| 4 | \$50 | \$50 |
| 5 | \$63 | \$63 |
| 6 | \$77 | \$77 |
| 7 | \$90 | \$90 |
| 8 | \$104 | \$104 |
| 9 | \$117 | \$117 |
| 10 | \$131 | \$131 |
| 11 | \$144 | \$144 |
| 12 | \$158 | \$158 |
| L | \$150 | \$150 |

NOTES: Stacks 4-high.

! Ganging brackets work with armless Guest/Multi-purpose models only.

HISB6DF

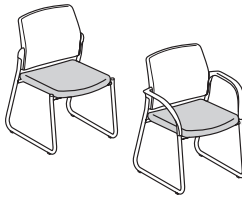

MULTI-PURPOSE

Multi-Fabric
Sled Base

DIMENSIONS

| | | | |
|--------------|--------------------------------|---------------------------------|--------------------------------|
| Depth: | 23 ³ / ₄ | Arm Width: | 21 ¹ / ₂ |
| Width: | 25 | Seat to Floor Height: | 18 ³ / ₈ |
| Height: | 33 ¹ / ₂ | Usable Seat Depth: | 17 ³ / ₈ |
| Seat Depth: | 17 ³ / ₈ | Ship Weight (upholstered back): | 30 |
| Seat Width: | 18 ³ / ₄ | Cube (upholstered back): | 15.1 |
| Back Width: | 18 ¹ / ₄ | COM (back): | 0.75 |
| Back Height: | 18 ¹ / ₈ | COM (seat): | 0.75 |
| | | Weight Rating: | 300 lbs. |

FABRIC PRICE CODES

| | | |
|--------------------------------|--------------|--------------|
| 1 | \$541 | |
| <i>Add to Base Price Above</i> | | |
| | Back | Seat |
| 2 | \$18 | \$18 |
| 3 | \$36 | \$36 |
| 4 | \$50 | \$50 |
| 5 | \$63 | \$63 |
| 6 | \$77 | \$77 |
| 7 | \$90 | \$90 |
| 8 | \$104 | \$104 |
| 9 | \$117 | \$117 |
| 10 | \$131 | \$131 |
| 11 | \$144 | \$144 |
| 12 | \$158 | \$158 |
| L | \$150 | \$150 |

! Ganging brackets work with armless Guest/Multi-purpose models only.

HON Recommendation: HIGS6DF.F.H.U.CU__UR__.T - List Price \$571

HOW TO SPECIFY

| | | | | | | |
|----------------------------|--|--|-------------------------|---------------------------|---------------------------|--|
| Select Model Number | Select Arm Type | Select Glide | Select Back Type | Select Back Fabric | Select Seat Fabric | Select Frame |
| | F Fixed Arms (+ \$30) N Armless | E Glide H Black Hard Caster S Black All-Surface Caster (+ \$30) <i>Casters available on HIGS6DF only</i> | U Upholstered | See page 351 | See page 351 | T Black BLCK Textured Black Mica PK7 Textured Designer White (+ \$35) PLAT Textured Platinum Metallic PR8T Textured Silver (+ \$35) |
| HIGS6DF | F | H | U | CU10 | UR10 | T |

IGNITION® Multi-Fabric Stools

GSA SIN 33721



Icon Legend on page 17

HICS7DF



CAFÉ-HEIGHT STOOL

Multi-Fabric
Four Legs

DIMENSIONS

| | | | |
|--------------|-----|---------------------------------|----------|
| Depth: | 23 | Arm Width: | 21½ |
| Width: | 25 | Seat to Floor Height: | 31 |
| Height: | 46½ | Usable Seat Depth: | 17¾ |
| Seat Depth: | 17¾ | Ship Weight (upholstered back): | 37 |
| Seat Width: | 18¾ | Cube (upholstered back): | 21.8 |
| Back Width: | 18¼ | COM (back): | 0.75 |
| Back Height: | 18½ | COM (seat): | 0.75 |
| | | Weight Rating: | 300 lbs. |

FABRIC PRICE CODES

1 \$663

Add to Base Price Above

| | Back | Seat |
|-----------|--------------|--------------|
| 2 | \$18 | \$18 |
| 3 | \$36 | \$36 |
| 4 | \$50 | \$50 |
| 5 | \$63 | \$63 |
| 6 | \$77 | \$77 |
| 7 | \$90 | \$90 |
| 8 | \$104 | \$104 |
| 9 | \$117 | \$117 |
| 10 | \$131 | \$131 |
| 11 | \$144 | \$144 |
| 12 | \$158 | \$158 |
| L | \$150 | \$150 |

! Ganging brackets work with armless Guest/Multi-purpose models only.

HON Recommendation: HICS7DF.F.E.U.CU__UR__T - List Price \$693

HOW TO SPECIFY

| Select Model Number | Select Arm Type | Select Glide | Select Back Type | Select Back Fabric | Select Seat Fabric | Select Frame |
|---------------------|--|----------------|----------------------|--------------------|--------------------|--|
| | F Fixed Arms (+ \$30) N Armless | E Glide | U Upholstered | See page 351 | See page 351 | T Black BLCK Textured Black Mica PK7 Textured Designer White (+ \$35) PLAT Textured Platinum Metallic PR8T Textured Silver (+ \$35) |
| HICS7DF | F | E | U | CU10 | UR10 | T |



HIGCL



GUEST CHAIR

Fixed Arms
Glides

DIMENSIONS

| | | | |
|--------------|-----|-----------------------|----------|
| Depth: | 24 | Arm Width: | 19¼ |
| Width: | 23 | Seat to Floor Height: | 18½ |
| Height: | 35½ | Usable Seat Depth: | 16¾ |
| Seat Depth: | 18 | Ship Weight: | 42 |
| Seat Width: | 19½ | Cube: | 15.2 |
| Back Width: | 19½ | COM: | 2.0 |
| Back Height: | 20 | Weight Rating: | 300 lbs. |

FABRIC PRICE CODES

| | | | |
|----------|--------------|-----------|--------------|
| 1 | \$498 | 8 | \$774 |
| 2 | \$546 | 9 | \$810 |
| 3 | \$594 | 10 | \$846 |
| 4 | \$630 | 11 | \$882 |
| 5 | \$666 | 12 | \$918 |
| 6 | \$702 | L | \$798 |
| 7 | \$738 | | |

HON Recommendation: HIGCL.E.U.CU__T - List Price \$498

HOW TO SPECIFY

| | | | | |
|---|-------------------------------------|---|--|--|
| Select Model Number HIGCL | Select Glide E Glide E | Select Back Type U Upholstered U | Select Fabric See page 351 CU10 | Select Frame T Black BLCK Textured Black Mica PLAT Textured Platinum Metallic T |
|---|-------------------------------------|---|--|--|

HIB50

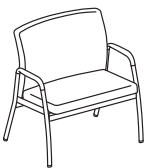

BARITRATIC LOUNGE

Fixed Arms
Glides

DIMENSIONS

| | | | |
|--------------|-----|-----------------------|----------|
| Depth: | 25½ | Arm Width: | 30 |
| Width: | 33¾ | Seat to Floor Height: | 20 |
| Height: | 35¾ | Usable Seat Depth: | 18¾ |
| Seat Depth: | 18¾ | Ship Weight: | 70 |
| Seat Width: | 29¾ | Cube: | 27.5 |
| Back Width: | 29 | COM: | 2.5 |
| Back Height: | 19¼ | Weight Rating: | 500 lbs. |

FABRIC PRICE CODES



| | | | |
|----------|---------------|-----------|---------------|
| 1 | \$1448 | 8 | \$1793 |
| 2 | \$1508 | 9 | \$1838 |
| 3 | \$1568 | 10 | \$1883 |
| 4 | \$1613 | 11 | \$1928 |
| 5 | \$1658 | 12 | \$1973 |
| 6 | \$1703 | L | — |
| 7 | \$1748 | | |



HOW TO SPECIFY

| | | | | | |
|---|---|-------------------------------------|---|--|--|
| Select Model Number HIB50 | Select Arm Type F Fixed Arms F | Select Glide E Glide E | Select Back Type U Upholstered U | Select Fabric See page 351 CU10 | Select Frame T Black BLCK Textured Black Mica PLAT Textured Platinum Metallic T |
|---|---|-------------------------------------|---|--|--|

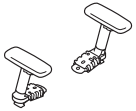

IGNITION® Task Chair Options

GSA SIN 33721

| ARM STYLE | CODE | DESCRIPTION | PRICE |
|--|----------|--------------------------------------|---------------|
| | N | Armless | +\$0 |
|  | F | Fixed Arms | +\$65 |
|  | A | Height and Width Adjustable Arms | +\$85 |
|  | V | All-Adjustable Arms (includes Pivot) | +\$130 |
|  | P | Fixed Polished Aluminum Arms | +\$175 |

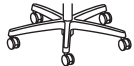
| BACK STYLE | CODE | DESCRIPTION | PRICE |
|---|----------|-------------|-------------|
|  | U | Upholstered | +\$0 |
|  | M | Mesh | +\$0 |

| BASE | CODE | DESCRIPTION | PRICE |
|---|-----------|-------------------|---------------|
|  | SB | Standard Base | +\$0 |
|  | PA | Polished Aluminum | +\$110 |

| CASTERS | CODE | DESCRIPTION | PRICE |
|--|----------|---|--------------|
|  | A | Black All-Surface Caster <i>*Must specify for model HIWM8 only</i> | +\$0 |
|  | H | Black Hard Caster | +\$0 |
|  | S | Black All-Surface Caster | +\$30 |

SEATING

HON BRANDED FABRICS

| GRADE 1 | GRADE 2 | GRADE 3 | GRADE L |
|------------|-----------------|-----------|-----------------|
| Apex | Appoint Seating | In Season | Denver Leather* |
| Attire | Blume | Moxie | |
| Centurion | Clyde | Parker | |
| Compass | Dotty | Purl | |
| Contourett | Rush | Quill | |
| Dapper | Seed** | | |
| Ensemble | Spin Seating | | |
| Hamilton | Whisper Vinyl | | |
| Inertia | | | |
| Optic** | | | |
| Pebble | | | |

For a complete list of fabrics, including partnership fabrics, go to hon.com/fabricsandfinishes.

Reference Fabric Color Combinations on pages 18-22 for color codes and legend on page 19 for lead times. For additional HON to Supply COM fabric grade pricing, go to honready.hon.com and click on the HON to Supply COM link.

*Denver Leather (SS) may not be available on every model within a specific series, please refer to the model's page for details.

**Not available as a back upholstery on Ignition[®] 2.0.

 For Fire Code model, availability, and ordering method, refer to page 216. Available on select models, contact HON Customer Support for availability.

IGNITION®



Icon Legend on page 17

HITL1



TASK LOW-BACK

Pneumatic
Back Height Adjustment
Swivel
Tilt
Tilt Tension
Tilt Lock
Functions: **A, B, E, J, K, L**
(Function Key on pages 212-213)

DIMENSIONS

Upholstered Back
Width: 17½
Upholstered Back
Height: 18¾-21¾
Mesh Back Width: 17½
Mesh Back Height: 20¾-23¼
Depth: 36
Width: 27½
Height: 41
Seat Depth: 17
Seat Width: 19

Adjustable Arms Width: 17-19½
Fixed Arms Width: 20
Seat to Floor Height: 17-21½
Usable Seat Depth: 15¾
Ship Weight (upholstered back): 50
Ship Weight (mesh back): 45
Cube (upholstered back): 10.8
Cube (mesh back): 10.8
COM (upholstered back): 2.0
COM (mesh back): 1.0
Weight Rating: 300 lbs.

FABRIC PRICE CODES

| | | | |
|---|-------|----|--------|
| 1 | \$655 | 8 | \$931 |
| 2 | \$703 | 9 | \$967 |
| 3 | \$751 | 10 | \$1003 |
| 4 | \$787 | 11 | \$1039 |
| 5 | \$823 | 12 | \$1075 |
| 6 | \$859 | L | — |
| 7 | \$895 | | |

NOTES: See page 356 for arm packs.

HITL2



TASK LOW-BACK

Pneumatic
Back Height Adjustment
Synchro-tilt
Tilt Tension
Tilt Lock
Seat Glide
Functions: **A, B, D, E, J, A-D, L**
(Function Key on pages 212-213)

DIMENSIONS

Upholstered Back
Width: 17½
Upholstered Back
Height: 19½-22½
Mesh Back Width: 17½
Mesh Back Height: 20¾-23¼
Depth: 38½
Width: 27½
Height: 43
Seat Depth: 16-18
Seat Width: 19

Adjustable Arms Width: 17-19½
Fixed Arms Width: 20
Seat to Floor Height: 17-21½
Usable Seat Depth: 15½-17½
Ship Weight (upholstered back): 54
Ship Weight (mesh back): 49
Cube (upholstered back): 10.8
Cube (mesh back): 10.8
COM (upholstered back): 2.0
COM (mesh back): 1.0
Weight Rating: 300 lbs.

FABRIC PRICE CODES

| | | | |
|---|-------|----|--------|
| 1 | \$739 | 8 | \$1015 |
| 2 | \$787 | 9 | \$1051 |
| 3 | \$835 | 10 | \$1087 |
| 4 | \$871 | 11 | \$1123 |
| 5 | \$907 | 12 | \$1159 |
| 6 | \$943 | L | — |
| 7 | \$979 | | |

NOTES: See page 356 for arm packs.

HITL3



TASK LOW-BACK

Pneumatic
Back Height Adjustment
Synchro-tilt
Back Angle Adjustment
Tilt Tension
Tilt Lock
Seat Glide
Functions: **A, B, D, E, A-D, A-E, L**
(Function Key on pages 212-213)

DIMENSIONS

Upholstered Back
Width: 17½
Upholstered Back
Height: 20¾-23¾
Mesh Back Width: 17½
Mesh Back Height: 20¾-23¼
Depth: 39
Width: 27
Height: 44
Seat Depth: 16-18
Seat Width: 19

Adjustable Arms Width: 17-19½
Fixed Arms Width: 20
Seat to Floor Height: 17-21½
Usable Seat Depth: 14½-16½
Ship Weight (upholstered back): 58
Ship Weight (mesh back): 53
Cube (upholstered back): 10.8
Cube (mesh back): 10.8
COM (upholstered back): 2.0
COM (mesh back): 1.0
Weight Rating: 300 lbs.

FABRIC PRICE CODES

| | | | |
|---|--------|----|--------|
| 1 | \$788 | 8 | \$1064 |
| 2 | \$836 | 9 | \$1100 |
| 3 | \$884 | 10 | \$1136 |
| 4 | \$920 | 11 | \$1172 |
| 5 | \$956 | 12 | \$1208 |
| 6 | \$992 | L | — |
| 7 | \$1028 | | |

NOTES: See page 356 for arm packs.

HON Recommendation: HITL1.A.H.M.CU__T.SB - List Price \$740

HOW TO SPECIFY

| | | | | | | |
|-------------------------------------|--|--|--|--------------------------------------|--------------------------------|--|
| Select Model Number HITL1 | Select Arm Type N Armless F Fixed Arms - Black (+ \$65) A Height and Width Adjustable Arms (+ \$85) V All-Adjustable Arms (includes Pivot) (+ \$130) P Fixed Arms - Polished (+ \$175) | Select Caster/Glide H Black Hard Caster S Black All-Surface Caster (+ \$40) | Select Back Type U Upholstered M Mesh | Select Fabric See page 351 | Select Frame T Black | Select Base SB Standard Base PA Polished Aluminum (+ \$110) |
| HITL1 | A | H | M | CU10 | T | SB |

SEATING



HIWM1



MID-BACK

Pneumatic
Back Height Adjustment
Swivel
Tilt
Tilt Tension
Tilt Lock
Functions: **A, B, E, J, K, L**
(Function Key on pages 212-213)

DIMENSIONS

Upholstered Back Width: 18½
Upholstered Back Height: 21-24
Mesh Back Width: 19
Mesh Back Height: 21½-24
Depth: 35½
Width: 27
Height: 44
Seat Depth: 18
Seat Width: 20
Adjustable Arms Width: 18-20½
Fixed Arms Width: 20

Seat to Floor Height: 17-21½
Usable Seat Depth: 17½
Ship Weight (upholstered back): 54
Ship Weight (mesh back): 48
Cube (upholstered back): 10.8
Cube (mesh back): 10.8
COM (upholstered back): 2.0
COM (mesh back): 1.0
Weight Rating: 300 lbs.

FABRIC PRICE CODES

| | | | |
|---|-------|----|--------|
| 1 | \$720 | 8 | \$996 |
| 2 | \$768 | 9 | \$1032 |
| 3 | \$816 | 10 | \$1068 |
| 4 | \$852 | 11 | \$1104 |
| 5 | \$888 | 12 | \$1140 |
| 6 | \$924 | L | \$1020 |
| 7 | \$960 | | |

NOTES: See page 356 for arm packs.

HIWM2



MID-BACK

Pneumatic
Back Height Adjustment
Synchro-tilt
Tilt Tension
Tilt Lock
Seat Glide
Functions:
A, B, D, E, J, A-D, L
(Function Key on pages 212-213)

DIMENSIONS

Upholstered Back Width: 18½
Upholstered Back Height: 21-24
Mesh Back Width: 19
Mesh Back Height: 21½-24
Depth: 38
Width: 27
Height: 46½
Seat Depth: 17-19
Seat Width: 20
Adjustable Arms Width: 18-20½
Fixed Arms Width: 20

Seat to Floor Height: 17¼-21¾
Usable Seat Depth: 16¼-18¼
Ship Weight (upholstered back): 58
Ship Weight (mesh back): 52
Cube (upholstered back): 10.8
Cube (mesh back): 10.8
COM (upholstered back): 2.0
COM (mesh back): 1.0
Weight Rating: 300 lbs.

FABRIC PRICE CODES

| | | | |
|---|--------|----|--------|
| 1 | \$797 | 8 | \$1073 |
| 2 | \$845 | 9 | \$1109 |
| 3 | \$893 | 10 | \$1145 |
| 4 | \$929 | 11 | \$1181 |
| 5 | \$965 | 12 | \$1217 |
| 6 | \$1001 | L | \$1097 |
| 7 | \$1037 | | |

NOTES: See page 356 for arm packs.

HIWM3



MID-BACK

Pneumatic
Back Height Adjustment
Synchro-tilt
Back Angle Adjustment
Tilt Tension
Tilt Lock
Seat Glide
Functions:
A, B, D, E, A-D, A-E, L
(Function Key on pages 212-213)

DIMENSIONS

Upholstered Back Width: 18½
Upholstered Back Height: 21-24
Mesh Back Width: 19
Mesh Back Height: 21½-24
Depth: 39
Width: 27
Height: 44
Seat Depth: 17-19
Seat Width: 20
Adjustable Arms Width: 18-20½
Fixed Arms Width: 20

Seat to Floor Height: 17¼-21¾
Usable Seat Depth: 15¼-17¼
Ship Weight (upholstered back): 63
Ship Weight (mesh back): 58
Cube (upholstered back): 10.8
Cube (mesh back): 10.8
COM (upholstered back): 2.0
COM (mesh back): 1.0
Weight Rating: 300 lbs.

FABRIC PRICE CODES

| | | | |
|---|--------|----|--------|
| 1 | \$850 | 8 | \$1126 |
| 2 | \$898 | 9 | \$1162 |
| 3 | \$946 | 10 | \$1198 |
| 4 | \$982 | 11 | \$1234 |
| 5 | \$1018 | 12 | \$1270 |
| 6 | \$1054 | L | \$1150 |
| 7 | \$1090 | | |

NOTES: See page 356 for arm packs.

HON Recommendation: HIWM2.A.H.M.CU__T.SB - List Price \$882

HOW TO SPECIFY

| Select Model Number | Select Arm Type | Select Caster/Glide | Select Back Type | Select Fabric | Select Frame | Select Base |
|---|--|---------------------------------------|------------------|----------------|--|-------------|
| N Armless F Fixed Arms - Black (+ \$65) A Height and Width Adjustable Arms (+ \$85) V All-Adjustable Arms (includes Pivot) (+ \$130) P Fixed Arms - Polished (+ \$175) | H Black Hard Caster S Black All-Surface Caster (+ \$40) | U Upholstered M Mesh | See page 351 | T Black | SB Standard Base PA Polished Aluminum (+ \$110) | |
| HIWM1 | A | H | M | CU10 | T | SB |

IGNITION®



Icon Legend on page 17

HIEH1



EXECUTIVE HIGH-BACK

Pneumatic
Back Height Adjustment
Swivel
Tilt
Tilt Tension
Tilt Lock
Functions: **A, B, E, F, K, L**
(Function Key on pages 212-213)

DIMENSIONS

Depth: 38½
Width: 27
Height: 47½
Seat Depth: 18
Seat Width: 20
Back Width: 20
Back Height: 24¾-27¾
Arm Width: 20
Seat to Floor Height: 16¾-21¼
Usable Seat Depth: 17⅞
Ship Weight: 56
Cube: 16.0
COM: 2.5
Weight Rating: 300 lbs.

FABRIC PRICE CODES

| | | | |
|---|-------|----|--------|
| 1 | \$745 | 8 | \$1021 |
| 2 | \$793 | 9 | \$1057 |
| 3 | \$841 | 10 | \$1093 |
| 4 | \$877 | 11 | \$1129 |
| 5 | \$913 | 12 | \$1165 |
| 6 | \$949 | L | \$1045 |
| 7 | \$985 | | |

NOTES: See page 356 for arm packs.

HIEH2



EXECUTIVE HIGH-BACK

Pneumatic
Back Height Adjustment
Synchro-tilt
Tilt Tension
Seat Glide
Functions: **A, B, D, E, J, A-D, L**
(Function Key on pages 212-213)

DIMENSIONS

Depth: 41
Width: 27
Height: 49
Seat Depth: 17-19
Seat Width: 20
Back Width: 19½
Back Height: 24¾-27¾
Arm Width: 20
Seat to Floor Height: 17-21½
Usable Seat Depth: 16½-18
Ship Weight: 61
Cube: 16.0
COM: 2.5
Weight Rating: 300 lbs.

FABRIC PRICE CODES

| | | | |
|---|--------|----|--------|
| 1 | \$828 | 8 | \$1104 |
| 2 | \$876 | 9 | \$1140 |
| 3 | \$924 | 10 | \$1176 |
| 4 | \$960 | 11 | \$1212 |
| 5 | \$996 | 12 | \$1248 |
| 6 | \$1032 | L | \$1128 |
| 7 | \$1068 | | |

NOTES: See page 356 for arm packs.

HIEH3



EXECUTIVE HIGH-BACK

Pneumatic
Back Height Adjustment
Synchro-tilt
Back Angle Adjustment
Tilt Tension
Seat Glide
Functions: **A, B, D, E, A-D, A-E, L**
(Function Key on pages 212-213)

DIMENSIONS

Depth: 45½
Width: 27
Height: 49
Seat Depth: 17-19
Seat Width: 20
Back Width: 19½
Back Height: 24¾-27¾
Arm Width: 20
Seat to Floor Height: 17-21½
Usable Seat Depth: 15¼-17¼
Ship Weight: 65
Cube: 16.0
COM: 2.5
Weight Rating: 300 lbs.

FABRIC PRICE CODES

| | | | |
|---|--------|----|--------|
| 1 | \$877 | 8 | \$1153 |
| 2 | \$925 | 9 | \$1189 |
| 3 | \$973 | 10 | \$1225 |
| 4 | \$1009 | 11 | \$1261 |
| 5 | \$1045 | 12 | \$1297 |
| 6 | \$1081 | L | \$1177 |
| 7 | \$1117 | | |

NOTES: See page 356 for arm packs.

HON Recommendation: HIEH1.F.H.U.CU__T.SB - List Price \$810

HOW TO SPECIFY

| Select Model Number | Select Arm Type | Select Caster/Glide | Select Back Type | Select Fabric | Select Frame | Select Base |
|---------------------|--|--|---------------------------|---------------|---------------------|--|
| HIEH1 | F N Armless F Fixed Arms - Black (+ \$65) A Height and Width Adjustable Arms (+ \$85) V All-Adjustable Arms (includes Pivot) (+ \$130) P Fixed Arms - Polished (+ \$175) | H H Black Hard Caster S Black All-Surface Caster (+ \$40) | U U Upholstered | See page 351 | T T Black | SB Standard Base PA Polished Aluminum (+ \$110) |



HITS5



TASK STOOL

Pneumatic
Swivel Back Height
Adjustment
Adjustable Footrest
Functions: **A, B, E**
(Function Key on pages
212-213)

DIMENSIONS

| | | | |
|-----------------------------|---------|---------------------------------|----------|
| Upholstered Back Width: | 17½ | Adjustable Arms Width: | 17-19½ |
| Upholstered Back Height: | 18¾-21¾ | Fixed Arms Width: | 20 |
| Mesh Back Width: | 17½ | Seat to Floor Height: | 23⅝-33⅝ |
| Mesh Back Height: | 20¾-23¾ | Usable Seat Depth: | 15¾ |
| Depth: | 27½ | Ship Weight (upholstered back): | 56 Ⓢ |
| Width: | 27 | Ship Weight (mesh back): | 51 Ⓢ |
| Height: | 44 | Cube (upholstered back): | 10.8 |
| Seat Depth: | 17 | Cube (mesh back): | 10.8 |
| Seat Width: | 19 | COM (upholstered back): | 2.0 |
| | | COM (mesh back): | 1.0 |
| | | Weight Rating: | 300 lbs. |

FABRIC PRICE CODES

| | | | |
|----------|---------------|-----------|---------------|
| 1 | \$774 | 8 | \$1050 |
| 2 | \$822 | 9 | \$1086 |
| 3 | \$870 | 10 | \$1122 |
| 4 | \$906 | 11 | \$1158 |
| 5 | \$942 | 12 | \$1194 |
| 6 | \$978 | L | — |
| 7 | \$1014 | | |

NOTES: See page 356 for arm packs.

HIWM8



TASK MID-BACK

Big and Tall
Pneumatic
Swivel-tilt
Tilt Tension
Functions: **A, E, F, K, L**
(Function Key on pages
212-213)

DIMENSIONS

| | | | |
|--------------|-----|-----------------------|----------|
| Depth: | 28 | Arm Width: | 23-25½ |
| Width: | 32¼ | Seat to Floor Height: | 16⅝-20⅝ |
| Height: | 43⅝ | Usable Seat Depth: | 19½ |
| Seat Depth: | 19½ | Ship Weight: | 60 |
| Seat Width: | 23½ | Cube: | 16.0 |
| Back Width: | 23½ | COM: | 3.0 |
| Back Height: | 23 | Weight Rating: | 450 lbs. |

FABRIC PRICE CODES

| | | | |
|----------|---------------|-----------|---------------|
| 1 | \$1424 | 8 | \$1838 |
| 2 | \$1496 | 9 | \$1892 |
| 3 | \$1568 | 10 | \$1946 |
| 4 | \$1622 | 11 | \$2000 |
| 5 | \$1676 | 12 | \$2054 |
| 6 | \$1730 | L | — |
| 7 | \$1784 | | |

NOTES: See page 356 for arm packs.

HON Recommendation: HITS5.A.H.M.CU__T.SB - List Price \$859

HOW TO SPECIFY

| Select Model Number | Select Arm Type | Select Caster/Glide | Select Back Type | Select Fabric | Select Frame | Select Base |
|---|---|--|------------------|----------------|-------------------------|-------------|
| N Armless F Fixed Arms - Black (+ \$65) A Height and Width Adjustable Arms (+ \$85) V All-Adjustable Arms (includes Pivot) (+ \$130) P Fixed Arms - Polished (+ \$175) | H Black Hard Caster S Black All-Surface Caster (+ \$40) A Black All-Surface Caster (available on model HIWM8 only) <i>H and S caster options not available on model HIWM8</i> | U Upholstered M Mesh <i>Mesh back not available on HIWM8</i> | See page 351 | T Black | SB Standard Base | |

HITS5 . **A** . **H** . **M** . **CU10** . **T** . **SB**

HI2ATA

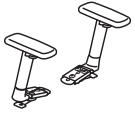

ADJUSTABLE ARMS

Height and Width
Functions: **S**
(Function Key on pages 212-213)

DIMENSIONS

Adjustable Arms Width: 17-19½
Height from Seat: 8-11
Ship Weight: 8
Cube: 1.0

LIST PRICE

\$132

HI2AAA

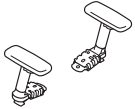

ALL-ADJUSTABLE ARMS

Height, Width, Depth and Pivot

DIMENSIONS

Adjustable Arms Width: 17-20
Height from Seat: 7-11
Ship Weight: 8
Cube: 1.0

LIST PRICE

\$178

HI2FHA



FIXED HEIGHT ARMS

DIMENSIONS

Arm Width: 20
Height from Seat: 9½
Ship Weight: 7
Cube: 1.0

LIST PRICE

\$122

HIPAA

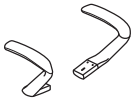

POLISHED ALUMINUM ARMS

Fixed Height

DIMENSIONS

Arm Width: 20
Height from Seat: 9½
Ship Weight: 10
Cube: 1.0

LIST PRICE

\$201

HSCASTER

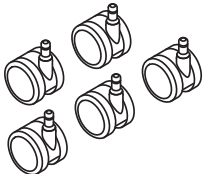

SET OF 5 ALL-SURFACE CASTERS

DIMENSIONS

Size: 60mm
Ship Weight: 2
Cube: 0.1

LIST PRICE

\$59

ⓘ Available in Black finish only, no specification needed.

OPEN MARKET

HOW TO SPECIFY

Select Model Number

Select Frame

Specify for models HI2ATA, HI2AAA, and HI2FHA

- T** Black
- DWX** Designer White
- TI** Titanium

HI2ATA.

T



INSTIGATE™ Mesh Guest Chairs

HVL508



GUEST CHAIR

Leg Base
Armless
Stacks up to Four High

DIMENSIONS

| | | | |
|-------------|-----|-----------------------|----------|
| Depth: | 22¼ | Back Height: | 19 |
| Width: | 24 | Seat to Floor Height: | 18¾ |
| Height: | 35¾ | Usable Seat Depth: | 17½ |
| Seat Depth: | 17½ | Ship Weight: | 18.8 |
| Seat Width: | 18½ | Cube: | 3.1 |
| Back Width: | 17½ | Weight Rating: | 250 lbs. |

PRICE CODE

Fabric **\$247**

NOTES: Mesh back. Black fabric seat. Double cross bar frame increases strength and durability. Stackable up to 4-high. **HON 5-Year Limited Warranty.**

HON Recommendation: HVL508.ES10 - List Price \$247

HVL518



GUEST CHAIR

Leg Base
Arms
Stacks up to Four High

DIMENSIONS

| | | | |
|--------------|-----|-----------------------|----------|
| Depth: | 22¼ | Arm Width: | 20¼ |
| Width: | 24 | Seat to Floor Height: | 17¾ |
| Height: | 35¾ | Usable Seat Depth: | 17½ |
| Seat Depth: | 17½ | Ship Weight: | 22.2 |
| Seat Width: | 18½ | Cube: | 3.2 |
| Back Width: | 17½ | Weight Rating: | 250 lbs. |
| Back Height: | 19 | | |

PRICE CODE

Fabric **\$275**

NOTES: Mesh back. Fixed arms. Double cross bar frame increases strength and durability. Stackable up to 4-high. Black fabric seat. **HON 5-Year Limited Warranty.**

HON Recommendation: HVL518.ES10 - List Price \$275

HOW TO SPECIFY

| | |
|----------------------------|---------------------------------|
| Select Model Number | Select Fabric |
| | ES10 Black Fabric (only) |
| H V L 5 1 8 . | E S 1 0 |

INVITATION® 2110 SERIES

Want to see more? Scan here
to check out hon.com.



Invitation Guest Chairs
and Table Connectors.

INVITATION® 2110 SERIES

Invitation brings the comforts of home into the workplace. Enjoy the simple pleasure of welcoming guests in arm chairs with integrated tables. Invitation guest chairs coordinate with Invitation lounge seating to make any space more comfortable and cohesive. Arrange in rows, groups or any configuration to suit your space or needs. The practical design and long-lasting comfort adds up to a stylish Invitation.



FEATURES

- Contoured back rest on guest chairs delivers ergonomic comfort.
- Floating back design enables easy wipe-out cleaning.
- Guest chairs can be ganged together to create straight rows.
- Molded polymer seat shell increases comfort and durability.
- Solid hardwood in one of eight attractive finishes.
- Warranted for users up to 250 lbs.

INVITATION® 2110 Series Options

MODEL OPTIONS

H2111



Guest Chair

Leg Base, Arms

H2112

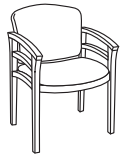

Guest Chair

Leg Base, Double
Rail Arms

HON BRANDED FABRICS

GRADE 1

Apex
Attire
Centurion
Compass
Contourett
Dapper
Ensemble
Hamilton
Inertia
Optic
Pebble

GRADE 2

Appoint Seating
Blume
Clyde
Dotty
Rush
Seed
Spin Seating
Whisper Vinyl

GRADE 3

In Season
Moxie
Parker
Purl
Quill

AVAILABLE FINISHES

Invitation® 2110 Series Seating is available in 8 wood finishes.

WOOD FINISHES

Bourbon Cherry (H)

Cognac (COGN)

Harvest (C)

Mahogany (N)

Mocha (MOCH)

Natural Maple (D)

Pinnacle (PINC)

Shaker Cherry (F)

For a complete list of fabrics, including partnership fabrics, go to hon.com/fabricsandfinishes.

Reference Fabric Color Combinations on pages 18-22 for color codes and legend on page 19 for lead times. COM yardage shown is for Pattern Cut only. Contact Customer Service for Railroaded yardage requirements. For additional HON to Supply COM fabric grade pricing, go to honready.hon.com and click on the HON to Supply COM link.

INVITATION® 2110 Series

GSA SIN 33721



Icon Legend on page 17

H2111



GUEST CHAIR

Leg Base
Arms

DIMENSIONS

| | | | |
|--------------|--------------------------------|-----------------------|--------------------------------|
| Depth: | 22 | Arm Width: | 18 ⁷ / ₈ |
| Width: | 23 ¹ / ₂ | Seat to Floor Height: | 18 ¹ / ₂ |
| Height: | 33 ³ / ₈ | Usable Seat Depth: | 17 |
| Seat Depth: | 17 | Ship Weight: | 24 |
| Seat Width: | 20 | Cube: | 15.0 |
| Back Width: | 21 | COM: | 1.5 |
| Back Height: | 16 | Weight Rating: | 250 lbs. |

FABRIC PRICE CODES

| | | | |
|---|--------|----|--------|
| 1 | \$1045 | 8 | \$1252 |
| 2 | \$1081 | 9 | \$1279 |
| 3 | \$1117 | 10 | \$1306 |
| 4 | \$1144 | 11 | \$1333 |
| 5 | \$1171 | 12 | \$1360 |
| 6 | \$1198 | L | — |
| 7 | \$1225 | | |

H2112



GUEST CHAIR

Leg Base
Double Rail Arms

DIMENSIONS

| | | | |
|--------------|--------------------------------|-----------------------|--------------------------------|
| Depth: | 22 | Arm Width: | 18 ⁷ / ₈ |
| Width: | 23 ¹ / ₂ | Seat to Floor Height: | 18 ¹ / ₂ |
| Height: | 33 ³ / ₈ | Usable Seat Depth: | 17 |
| Seat Depth: | 17 | Ship Weight: | 28 |
| Seat Width: | 20 | Cube: | 15.0 |
| Back Width: | 21 | COM: | 1.5 |
| Back Height: | 16 | Weight Rating: | 250 lbs. |

FABRIC PRICE CODES

| | | | |
|---|--------|----|--------|
| 1 | \$1148 | 8 | \$1355 |
| 2 | \$1184 | 9 | \$1382 |
| 3 | \$1220 | 10 | \$1409 |
| 4 | \$1247 | 11 | \$1436 |
| 5 | \$1274 | 12 | \$1463 |
| 6 | \$1301 | L | — |
| 7 | \$1328 | | |

HON Recommendation: H2111.MOCH.CU__ - List Price \$1045

HOW TO SPECIFY

Select
Model Number

H 2 1 1 1 .

Select
Finish

See page 359

M O C H .

Select
Fabric

See page 359

C U 1 0



INVITATION[®]

2110 Series Connectors

H2141



CONNECTORS

for Model H2111
One connector per two chairs

DIMENSIONS

| | | | |
|---------|---------------------------------|----------------|----------|
| Depth: | 13 ⁵ / ₁₆ | Ship Weight: | 2.0 |
| Width: | 4 ³ / ₈ | Cube: | 0.3 |
| Height: | 1 | Weight Rating: | 300 lbs. |

LIST PRICE

\$75

H2142

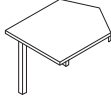

CORNER TABLE CONNECTOR

for Model H2111

DIMENSIONS

| | | | |
|---------|--------------------------------|----------------|----------|
| Depth: | 28 | Ship Weight: | 25.5 |
| Width: | 28 | Cube: | 2.6 |
| Height: | 17 ¹ / ₄ | Weight Rating: | 300 lbs. |

LIST PRICE

\$651



! Customer or dealer must attach leg to table.

H2143

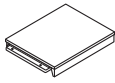

STRAIGHT TABLE CONNECTOR

for Model H2111

DIMENSIONS

| | | | |
|---------|--------------------------------|----------------|----------|
| Depth: | 17 ¹ / ₈ | Ship Weight: | 16.5 |
| Width: | 21 | Cube: | 1.5 |
| Height: | 17 ¹ / ₄ | Weight Rating: | 300 lbs. |

LIST PRICE

\$471

H2144



CONNECTORS

for Model H2112
One connector per two chairs

DIMENSIONS

| | | | |
|---------|---------------------------------|----------------|----------|
| Depth: | 13 ⁵ / ₁₆ | Ship Weight: | 2.0 |
| Width: | 4 ³ / ₈ | Cube: | 0.3 |
| Height: | 1 ⁵ / ₁₆ | Weight Rating: | 300 lbs. |

LIST PRICE

\$75

H2145

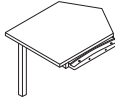

CORNER TABLE CONNECTOR

for Model H2112

DIMENSIONS

| | | | |
|---------|--------------------------------|----------------|----------|
| Depth: | 28 | Ship Weight: | 25.5 |
| Width: | 28 | Cube: | 2.6 |
| Height: | 17 ¹ / ₄ | Weight Rating: | 300 lbs. |

LIST PRICE

\$651



! Customer or dealer must attach leg to table.

H2146

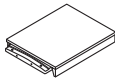

STRAIGHT TABLE CONNECTOR

for Model H2112

DIMENSIONS

| | | | |
|---------|--------------------------------|----------------|----------|
| Depth: | 17 ¹ / ₈ | Ship Weight: | 16.5 |
| Width: | 21 | Cube: | 1.5 |
| Height: | 17 ¹ / ₄ | Weight Rating: | 300 lbs. |

LIST PRICE

\$471

HOW TO SPECIFY

Select Model Number

Select Finish

See page 359

H 2 1 4 1 .

H

INVITATION® LOUNGE

Want to see more? Scan here
to check out hon.com.



Invitation Lounge.

INVITATION® LOUNGE

Welcome your guests in professional style. Enjoy the simple pleasure of relaxing on a sofa with a laptop or welcoming guests in plush arm chairs. The Invitation lounge collection combines gracefully sloping arms, tapered wood legs and the deep-foam comfort of separate seat cushions.



FEATURES

- Transitional design blends contemporary lines and traditional details.
- Clean lines and refined scale easily adapt to any private office or lobby.
- Contemporary tapered legs are offered in Platinum metallic or Black finish.
- Impressive design and fine craftsmanship in an affordably priced lounge chair.
- Removable seat cushion is deeply padded for added comfort.
- Warranted for users up to 250 lbs.

INVITATION® Lounge Options

MODEL OPTIONS

HFAA01



Arm Chair

HFALO2

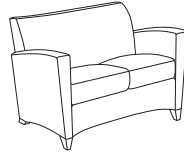

Love Seat

HFAS03

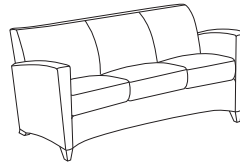

Sofa

LEG COLOR



| CODE | DESCRIPTION | PRICE |
|------|-------------|-------------|
| T | Black | +\$0 |



| | | |
|----|-------------------|-------------|
| T1 | Platinum Metallic | +\$0 |
|----|-------------------|-------------|

CARTON

| CODE | DESCRIPTION | PRICE |
|------|-------------|-------------|
| BC | Carton | +\$0 |

HON BRANDED FABRICS

GRADE 1

Apex
Attire
Centurion
Compass
Contourett
Dapper
Ensemble
Hamilton
Inertia
Optic
Pebble

GRADE 2

Appoint Seating
Blume
Clyde
Dotty
Rush
Seed
Spin Seating
Whisper Vinyl

GRADE 3

In Season
Moxie
Parker
Purl
Quill

GRADE L

Denver Leather

For a complete list of fabrics, including partnership fabrics, go to hon.com/fabricsandfinishes.

Reference Fabric Color Combinations on pages 18-22 for color codes and legend on page 19 for lead times. For additional HON to Supply COM fabric grade pricing, go to honready.hon.com and click on the HON to Supply COM link.

INVITATION® Lounge

GSA SIN 33721



Icon Legend on page 17

HFAA01

ARM CHAIR



DIMENSIONS

| | | | |
|--------------|-----|-----------------------|----------|
| Depth: | 31½ | Arm Width: | 20 |
| Width: | 30 | Seat to Floor Height: | 18 |
| Height: | 34 | Usable Seat Depth: | 20 |
| Seat Depth: | 20 | Ship Weight: | 73 |
| Seat Width: | 20 | Cube: | 27.0 |
| Back Width: | 20 | COM: | 5.0 |
| Back Height: | 16 | Weight Rating: | 250 lbs. |

FABRIC PRICE CODES

| | | | |
|---|--------|----|--------|
| 1 | \$2195 | 8 | \$2885 |
| 2 | \$2315 | 9 | \$2975 |
| 3 | \$2435 | 10 | \$3065 |
| 4 | \$2525 | 11 | \$3155 |
| 5 | \$2615 | 12 | \$3245 |
| 6 | \$2705 | L | \$3195 |
| 7 | \$2795 | | |

HFAL02

LOVE SEAT

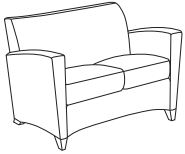

DIMENSIONS

| | | | |
|--------------|-----|-----------------------|----------|
| Depth: | 31¾ | Arm Width: | 40¼ |
| Width: | 50¼ | Seat to Floor Height: | 18 |
| Height: | 34¼ | Usable Seat Depth: | 20 |
| Seat Depth: | 20 | Ship Weight: | 112 |
| Seat Width: | 40¼ | Cube: | 55.7 |
| Back Width: | 40¼ | COM: | 6.5 |
| Back Height: | 16 | Weight Rating: | 250 lbs. |

FABRIC PRICE CODES

| | | | |
|---|--------|----|--------|
| 1 | \$3014 | 8 | \$3911 |
| 2 | \$3170 | 9 | \$4028 |
| 3 | \$3326 | 10 | \$4145 |
| 4 | \$3443 | 11 | \$4262 |
| 5 | \$3560 | 12 | \$4379 |
| 6 | \$3677 | L | \$4314 |
| 7 | \$3794 | | |

HFAS03

SOFA

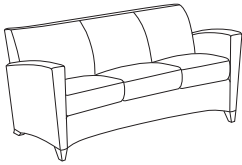

DIMENSIONS

| | | | |
|--------------|-----|-----------------------|----------|
| Depth: | 32 | Arm Width: | 60½ |
| Width: | 70½ | Seat to Floor Height: | 18 |
| Height: | 34½ | Usable Seat Depth: | 20 |
| Seat Depth: | 20 | Ship Weight: | 140 |
| Seat Width: | 60½ | Cube: | 72.0 |
| Back Width: | 60½ | COM: | 8.5 |
| Back Height: | 16 | Weight Rating: | 250 lbs. |

FABRIC PRICE CODES

| | | | |
|---|--------|----|--------|
| 1 | \$3835 | 8 | \$5008 |
| 2 | \$4039 | 9 | \$5161 |
| 3 | \$4243 | 10 | \$5314 |
| 4 | \$4396 | 11 | \$5467 |
| 5 | \$4549 | 12 | \$5620 |
| 6 | \$4702 | L | \$5535 |
| 7 | \$4855 | | |

HON Recommendation: HFAA01.PNS__T.BC - List Price \$2315

SEATING

HOW TO SPECIFY

| | | | |
|---|---|---|---|
| <p>Select Model Number</p> <p>HFAA01</p> | <p>Select Fabric</p> <p>See page 363</p> <p>PNS007</p> | <p>Select Leg Color</p> <p>T Black T1 Platinum Metallic</p> <p>T</p> | <p>Select Carton Option</p> <p>BC Carton</p> <p>BC</p> |
|---|---|---|---|



Lota Mesh Back Work and Side Chair with Voi® desks.

LOTA®

If you're looking for all-day comfort without breaking the bank, look no further than Lota. This mesh back family of task and guest chairs offer advanced features for customizable comfort that make it an upscale choice at an affordable price. Lota's control mechanism uses your own weight to provide perfect balance while reclining, and the pivoting arms put upper body support right where it's needed. If you sit for hours on end, put yourself in more control over your comfort.



FEATURES

- Weight-activated control responds naturally to your body's movements without any adjustments.
- 3-way arms adjust to various heights, depths and pivot positions.
- Multi-purpose chairs feature black arms and base.
- One-touch seat height adjustment easily moves the seat up and down.
- Tilt lock allows the user to lock out the tilt function.
- 360-degree swivel provides freedom of movement in any direction.
- Model H2281 available in black, charcoal and navy fabrics.
- H2285 available in black fabric only.
- Multi-purpose chairs stack four high on the floor.
- Warranted for users up to 275 lbs.

LOTA[®] Options

MODEL OPTIONS

H2281 *



Mid-Back Work (Mesh Back)

Pneumatic, Tilt Lock, Weight-Activated Control, Height, Depth, Pivot Adjustable Arms, Black Arms and Base

H2285



Multi-Purpose (Mesh Back)

4-Leg Stacking Frame, Fixed Arms

FRAME

| CODE | DESCRIPTION | PRICE |
|------|-------------|-------------|
| T | Black | +\$0 |

LOTA[®] MID-BACK WORK H2281

GRADE 1

Black Fabric
Charcoal Fabric
Navy Fabric

GRADE 2

GRADE 3

MULTI-PURPOSE H2285 HON BRANDED FABRICS

GRADE 1

Black Fabric

GRADE 2

GRADE 3

H2281*



MID-BACK WORK CHAIR

Mesh Back
 Pneumatic
 Tilt Lock
 Weight-activated Control
 Height, Depth, Pivot Adjustable
 Arms
 Black Arms and Base

DIMENSIONS

| | | | |
|--------------|-----|-----------------------|----------|
| Depth: | 27¾ | Arm Width: | 20⅞ |
| Width: | 26¾ | Seat to Floor Height: | 17⅞-21⅞ |
| Height: | 43½ | Usable Seat Depth: | 17¼ |
| Seat Depth: | 17¼ | Ship Weight: | 50 |
| Seat Width: | 19½ | Cube: | 6.5 |
| Back Width: | 17¾ | Weight Rating: | 250 lbs. |
| Back Height: | 23½ | | |

LIST PRICE

\$828

Functions: **A, E, F, L, Q**
 (Function Key on pages 212-213)

❗ Black Mesh back only.

HON Recommendation: H2281.VA10.T - List Price \$828

H2285



MULTI-PURPOSE CHAIR

Mesh Back
 4-Leg Stacking Frame
 Fixed Arms

DIMENSIONS

| | | | |
|--------------|-----|-----------------------|----------|
| Depth: | 24¾ | Arm Width: | 19⅞ |
| Width: | 23 | Seat to Floor Height: | 19⅞ |
| Height: | 34½ | Usable Seat Depth: | 17¾ |
| Seat Depth: | 17¾ | Ship Weight: | 20 |
| Seat Width: | 18⅞ | Cube: | 2.8 |
| Back Width: | 17⅞ | Weight Rating: | 250 lbs. |
| Back Height: | 17¾ | | |

LIST PRICE

\$417

NOTES: Casters and glides ship packaged together for customer's assembly choice. Stacks 4-high on floor.

❗ Available in VA10 Black fabric seat and Black frame only. Black Mesh back only.

* De-emphasized

HOW TO SPECIFY

Select Model Number

H 2 2 8 5 .

Select Fabric

VA10 Black Fabric
VA19 Charcoal Fabric
Specify for model H2281 only
VA90 Navy Fabric
Specify for model H2281 only

V A 1 0 .

Select Frame

T Black

T

MATTER™

Want to see more? Scan here
to check out hcn.com.



Matter™ Upholstered Chair with
5-Star Base with Preside® Table.

MATTER™

This modern take on the traditional task chair combines the comfort of a lounge chair and posture of a task chair. The swivel-tilt control allows you to find that reclining position that's just right for you, and the five-star base lets you move around effortlessly. This cool twist on the traditional guest chair puts the comfort of a lounge chair right on top of a traditional four-leg base.



FEATURES

- Brings a modern design aesthetic into any reception or guest area.
- Available in a 5-star base and 4-leg natural wood base. Hardwood legs in Harvest.
- Swivel-tilt mechanism offers a full range of reclining positions.
- Chrome base provides a contemporary accent.
- 360-degree swivel.
- Easily assembled in minutes.
- Backed by HON 5-year limited warranty.

MATTER™

Multi-Purpose Chairs

OPEN MARKET



Icon Legend on page 17

HVL232



GRAY UPHOLSTERED CHAIR

with 5-Star Base
Swivel
Tilt

DIMENSIONS

| | | | |
|--------------|---------------------------------|-----------------------|----------|
| Depth: | 24 ⁴ / ₅ | Arm Width: | 3 |
| Width: | 23 | Seat to Floor Height: | 19 |
| Height: | 34 | Usable Seat Depth: | 18 |
| Seat Depth: | 18 ³ / ₁₀ | Ship Weight: | 21 |
| Seat Width: | 16 ¹ / ₂ | Cube: | 5.6 |
| Back Width: | 23 | Weight Rating: | 250 lbs. |
| Back Height: | 12 ² / ₅ | | |

LIST PRICE

\$515

NOTES: HON 5-Year Limited Warranty.

HVL238



GRAY UPHOLSTERED CHAIR

Wood Leg Base
Harvest Wood Legs
4-Leg Wood Base

DIMENSIONS

| | | | |
|--------------|---------------------------------|-----------------------|----------|
| Depth: | 24 ⁴ / ₅ | Arm Width: | 3 |
| Width: | 23 | Seat to Floor Height: | 19 |
| Height: | 34 | Usable Seat Depth: | 18 |
| Seat Depth: | 18 ³ / ₁₀ | Ship Weight: | 21 |
| Seat Width: | 16 ¹ / ₂ | Cube: | 5.6 |
| Back Width: | 23 | Weight Rating: | 250 lbs. |
| Back Height: | 12 ² / ₅ | | |

LIST PRICE

\$475

NOTES: HON 5-Year Limited Warranty.

HOW TO SPECIFY

| | |
|---|--|
| <p>Select Model Number</p> <p>H V L 2 3 8 .</p> | <p>Select Fabric</p> <p>GRY01 Light Gray</p> <p>GR Y 0 1</p> |
|---|--|



Mav™ Single Lounge shown with West Hill™ Seating and Scramble™ Coffee Table.

MAV™

With plenty of base, back, and seat options offset with mid-century flair and richly colored fabrics, the Mav Single Lounge Series is designed to function well in virtually any space. Whether it's configured for a multi-use zone, in a private office, or to stand alone as a statement piece, Mav is an ideal place for impromptu or collaborative gatherings, a quick break, or focused, heads-down work.



FEATURES

- Subtle seat and back contours and refined details create an inviting, contemporary aesthetic.
- Choose from a mid-back or high-back option.
- Contoured arms provide support and create a striking look.
- Armless models offer a range of seated postures.
- High-back models available with a 4-star metal base with return-to-center, 4-leg wood base, or 5-star base with swivel knee tilt.
- Mid-back models offered in 4-star metal base with return-to-center, 4-leg wood base, wire sled base, or 5-star base with swivel knee tilt.
- Multi-Fabric option — seat cushion and frame can be specified in different fabrics for a modern aesthetic.
- Ottoman lets you kick up your feet or use as impromptu seating.
- Seat cushion attaches with Velcro for easy cleaning or replacement.
- Available in a wide range of cleanable fabrics to achieve the perfect look (see HON's Cleaning Guide).
- Choose from 10 wood base or 4 metal base finish options.

MAV™ Finish Options

HON BRANDED FABRICS

| GRADE 1 | GRADE 2 | GRADE 3 |
|--------------|-----------------|-----------|
| Apex | Appoint Seating | In Season |
| Attire* | Blume | Moxie |
| Centurion | Clyde | Parker |
| Compass | Dotty | Purl |
| Contourett** | Rush | Quill |
| Dapper | Seed* | |
| Ensemble | Spin Seating | |
| Hamilton | Whisper Vinyl** | |
| Inertia | | |
| Optic* | | |
| Pebble | | |

For a complete list of fabrics, including partnership fabrics, go to hon.com/fabricsandfinishes.

Reference Fabric Color Combinations on pages 18-22 for color codes and legend on page 19 for lead times.

*Not available on Single Fabric models or as multi-fabric frame option.

**Due to the inherent design of Mav™ high-back chairs, coated fabrics may show material gathers, particularly around the headrest.

LEG STYLE

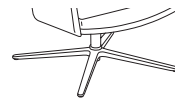

| CODE | DESCRIPTION | PRICE |
|---|-------------------------|--------------|
| 4S | 4-Star Return-to-Center | +\$0 |
| <i>Available in the following finishes:</i> | | |
| P8V | Textured Titanium | |
| P7A | Textured Charcoal | |
| P8X | Solar Black | +\$20 |
| Y | Polished | +\$50 |

LEG STYLE

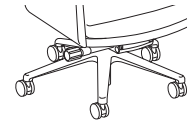

| CODE | DESCRIPTION | PRICE |
|---|---|--------------|
| 5S | 5-Star w/Swivel Knee Tilt, Hard Caster | +\$25 |
| 5SS | 5-Star w/Swivel Knee Tilt, All-Surface Caster | +\$55 |
| <i>Available in the following finishes:</i> | | |
| P8V | Textured Titanium | |
| P7A | Textured Charcoal | |
| P8X | Solar Black | +\$20 |
| Y | Polished | +\$50 |

LEG STYLE

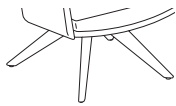

| CODE | DESCRIPTION | PRICE |
|---|------------------|---------------|
| WD | Wood | +\$250 |
| <i>Available in the following finishes:</i> | | |
| LFW1 | Florence Walnut | |
| LK11 | Kingswood Walnut | |
| LLA1 | Lowell Ash | |
| D | Natural Maple | |
| LN11 | Natural Recon | |
| LPE1 | Phantom Ecrú | |
| PINC | Pinnacle | |
| LPT1 | Portico Teak | |
| LSW1 | Skyline Walnut | |
| LSA1 | Sterling Ash | |

LEG STYLE



| CODE | DESCRIPTION | PRICE |
|---|-------------------|--------------|
| SD | Sled* | +\$0 |
| <i>Available in the following finishes:</i> | | |
| P8V | Textured Titanium | |
| P7A | Textured Charcoal | |
| P8X | Solar Black | +\$20 |
| Y | Polished | +\$50 |

*Available on Mid-Back models only

Low-Back, Multi-Fabric



High-Back, Multi-Fabric





HMAVMN



MID-BACK SINGLE LOUNGE, ARMLESS

DIMENSIONS

| | | | |
|---------------------------------|---------|-----------------------|----------|
| Depth (4-Star, 5-Star, & Wood): | 28¾ | Back Height: | 18¾ |
| Depth (Sled): | 27½ | Back Width: | 20 |
| Height (4-Star): | 29½ | Ship Weight: | 45 |
| Height (5-Star): | 33½-37¼ | Ship Weight (5-Star): | 55 |
| Height (Wood): | 30 | Cube: | 20.1 |
| Height (Sled): | 30¾ | COM: | 3.5 |
| Width: | 24 | Weight Rating: | 300 lbs. |
| Usable Seat Depth: | 19 | | |
| Seat to Floor Height: | 17¾ | | |
| Seat to Floor Height (5-Star): | 17¼-21 | | |
| Seat Width: | 21 | | |

FABRIC PRICE CODES

| | | | |
|----------|---------------|-----------|---------------|
| 1 | \$1458 | 8 | \$2092 |
| 2 | \$1542 | 9 | \$2108 |
| 3 | \$1628 | 10 | \$2194 |
| 4 | \$1699 | 11 | \$2279 |
| 5 | \$1794 | 12 | \$2365 |
| 6 | \$1891 | L | \$2965 |
| 7 | \$1991 | | |

HMAVMNMF



MID-BACK SINGLE LOUNGE, ARMLESS, MULTI-FABRIC

DIMENSIONS

| | | | |
|---------------------------------|---------|-----------------------|----------|
| Depth (4-Star, 5-Star, & Wood): | 28¾ | Back Height: | 18¾ |
| Depth (Sled): | 27½ | Back Width: | 20 |
| Height (4-Star): | 29½ | Ship Weight: | 45 |
| Height (5-Star): | 33½-37¼ | Ship Weight (5-Star): | 55 |
| Height (Wood): | 30 | Cube: | 20.1 |
| Height (Sled): | 30¾ | COM (Seat Cushion): | 1.5 |
| Width: | 24 | COM (Back/Frame): | 2.5 |
| Usable Seat Depth: | 19 | Weight Rating: | 300 lbs. |
| Seat to Floor Height: | 17¾ | | |
| Seat to Floor Height (5-Star): | 17¼-21 | | |
| Seat Width: | 21 | | |

FABRIC PRICE CODES

| | | |
|-----------|--------------------------------|--------------|
| 1 | \$1617 | |
| | <i>Add to Base Price Above</i> | |
| | Seat | Frame |
| 2 | \$24 | \$60 |
| 3 | \$48 | \$121 |
| 4 | \$69 | \$172 |
| 5 | \$96 | \$240 |
| 6 | \$124 | \$309 |
| 7 | \$152 | \$380 |
| 8 | \$181 | \$453 |
| 9 | \$186 | \$464 |
| 10 | \$210 | \$525 |
| 11 | \$235 | \$587 |
| 12 | \$259 | \$648 |

HON Recommendation: HMAVMNMF.PURL__PURL__4S__ - List Price \$1786

HOW TO SPECIFY

| | | | | |
|-----------------------------------|--|--|---|---|
| <p>Select Model Number</p> | <p>Select Fabric</p> <p>See page 372 Specify for single fabric model only</p> | <p>Select Seat Fabric</p> <p>See page 372 Specify for multi-fabric model only</p> | <p>Select Frame Fabric</p> <p>See page 372 Specify for multi-fabric model only</p> | <p>Select Base and Base Color</p> <p>See page 372</p> <p>4S 4-Star Return-to-Center 5S 5-Star, Hard Caster (+ \$25) 5SS 5-Star, All-Surface Caster (+ \$55) WD Wood (+ \$250) SD Sled</p> |
| HMAVMNMF | PURL05 | PURL05 | PURL03 | 4SP7A |

HMAVMA



MID-BACK SINGLE LOUNGE, ARMS

DIMENSIONS

| | | | |
|---------------------------------|---------|-----------------------|----------|
| Depth (4-Star, 5-Star, & Wood): | 28¾ | Back Height: | 18¾ |
| Depth (Sled): | 27½ | Back Width: | 20 |
| Height (4-Star): | 29½ | Arm Height: | 8½ |
| Height (5-Star): | 33½-37¼ | Ship Weight: | 53 |
| Height (Wood): | 30 | Ship Weight (5-Star): | 63 |
| Height (Sled): | 30¾ | Cube: | 20.1 |
| Width: | 25 | COM: | 4.0 |
| Usable Seat Depth: | 19 | Weight Rating: | 300 lbs. |
| Seat to Floor Height: | 17¾ | | |
| Seat to Floor Height (5-Star): | 17¼-21 | | |
| Seat Width: | 21 | | |

FABRIC PRICE CODES

| | | | |
|----------|---------------|-----------|---------------|
| 1 | \$1829 | 8 | \$2554 |
| 2 | \$1925 | 9 | \$2572 |
| 3 | \$2023 | 10 | \$2670 |
| 4 | \$2104 | 11 | \$2768 |
| 5 | \$2213 | 12 | \$2866 |
| 6 | \$2324 | L | \$3551 |
| 7 | \$2438 | | |

HMAVMAMF



MID-BACK SINGLE LOUNGE, ARMS, MULTI-FABRIC

DIMENSIONS

| | | | |
|---------------------------------|---------|-----------------------|----------|
| Depth (4-Star, 5-Star, & Wood): | 28¾ | Back Height: | 18¾ |
| Depth (Sled): | 27½ | Back Width: | 20 |
| Height (4-Star): | 29½ | Arm Height: | 8½ |
| Height (5-Star): | 33½-37¼ | Ship Weight: | 53 |
| Height (Wood): | 30 | Ship Weight (5-Star): | 63 |
| Height (Sled): | 30¾ | Cube: | 20.1 |
| Width: | 25 | COM (Seat Cushion): | 1.5 |
| Usable Seat Depth: | 19 | COM (Back/Frame): | 4.0 |
| Seat to Floor Height: | 17¾ | Weight Rating: | 300 lbs. |
| Seat to Floor Height (5-Star): | 17¼-21 | | |
| Seat Width: | 21 | | |

FABRIC PRICE CODES

| | | | |
|-----------|---------------|--------------------------------|-------------|
| 1 | \$1988 | | |
| | | <i>Add to Base Price Above</i> | |
| | | Seat | Back |
| 2 | \$24 | \$72 | |
| 3 | \$48 | \$145 | |
| 4 | \$69 | \$206 | |
| 5 | \$96 | \$288 | |
| 6 | \$124 | \$371 | |
| 7 | \$152 | \$457 | |
| 8 | \$181 | \$544 | |
| 9 | \$186 | \$557 | |
| 10 | \$210 | \$631 | |
| 11 | \$235 | \$704 | |
| 12 | \$259 | \$778 | |

HON Recommendation: HMAVMAMF.PURL__PURL__4S__ - List Price \$2181

HOW TO SPECIFY

| | | | | |
|-----------------------------------|--|--|---|---|
| <p>Select Model Number</p> | <p>Select Fabric</p> <p>See page 372</p> <p><i>Specify for single fabric model only</i></p> | <p>Select Seat Fabric</p> <p>See page 372</p> <p><i>Specify for multi-fabric model only</i></p> | <p>Select Frame Fabric</p> <p>See page 372</p> <p><i>Specify for multi-fabric model only</i></p> | <p>Select Base and Base Color</p> <p>See page 372</p> <p>4S 4-Star Return-to-Center</p> <p>5S 5-Star w/Swivel Knee Tilt, Hard Caster (+ \$25)</p> <p>5SS 5-Star w/Swivel Knee Tilt, All-Surface Caster (+ \$55)</p> <p>WD Wood (+ \$250)</p> <p>SD Sled</p> |
| HMAVMAMF | PURL05 | PURL05 | PURL03 | 4SP7A |



HMAVHN



HIGH-BACK SINGLE LOUNGE, ARMLESS

DIMENSIONS

| | | | |
|--------------------------------|--------|-----------------------|----------|
| Depth: | 30¼ | Back Height: | 32½ |
| Height (4-Star): | 43½ | Back Width: | 20 |
| Height (5-Star): | 47-50¾ | Ship Weight: | 50 |
| Height (Wood): | 44 | Ship Weight (5-Star): | 59 |
| Width: | 24 | Cube: | 29 |
| Usable Seat Depth: | 19 | COM: | 4.0 |
| Seat to Floor Height: | 17¾ | Weight Rating: | 300 lbs. |
| Seat to Floor Height (5-Star): | 17¼-21 | | |
| Seat Width: | 21 | | |

FABRIC PRICE CODES

| | | | |
|----------|---------------|-----------|---------------|
| 1 | \$1643 | 8 | \$2277 |
| 2 | \$1727 | 9 | \$2293 |
| 3 | \$1813 | 10 | \$2379 |
| 4 | \$1884 | 11 | \$2464 |
| 5 | \$1979 | 12 | \$2550 |
| 6 | \$2076 | L | \$3150 |
| 7 | \$2176 | | |

HMAVHNMF

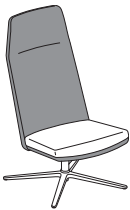

HIGH-BACK SINGLE LOUNGE, ARMLESS, MULTI-FABRIC

DIMENSIONS

| | | | |
|--------------------------------|--------|-----------------------|----------|
| Depth: | 30¼ | Back Height: | 32½ |
| Height (4-Star): | 43½ | Back Width: | 20 |
| Height (5-Star): | 47-50¾ | Ship Weight: | 50 |
| Height (Wood): | 44 | Ship Weight (5-Star): | 59 |
| Width: | 24 | Cube: | 29 |
| Usable Seat Depth: | 19 | COM (Seat Cushion): | 1.5 |
| Seat to Floor Height: | 17¾ | COM (Back/Frame): | 3.5 |
| Seat to Floor Height (5-Star): | 17¼-21 | Weight Rating: | 300 lbs. |
| Seat Width: | 21 | | |

FABRIC PRICE CODES

| | | | |
|-----------|---------------|--------------------------------|--------------|
| 1 | \$1802 | | |
| | | <i>Add to Base Price Above</i> | |
| | | Seat | Frame |
| 2 | \$24 | \$60 | |
| 3 | \$48 | \$121 | |
| 4 | \$69 | \$172 | |
| 5 | \$96 | \$240 | |
| 6 | \$124 | \$309 | |
| 7 | \$152 | \$380 | |
| 8 | \$181 | \$453 | |
| 9 | \$186 | \$464 | |
| 10 | \$210 | \$525 | |
| 11 | \$235 | \$587 | |
| 12 | \$259 | \$648 | |

HON Recommendation: HMAVHNMF.PURL__PURL__4S__ - List Price \$1971

HOW TO SPECIFY

| | | | | |
|--|--|--|---|---|
| <p>Select Model Number</p> <p>See page 372</p> <p><i>Specify for single fabric model only</i></p> | <p>Select Fabric</p> <p>See page 372</p> <p><i>Specify for single fabric model only</i></p> | <p>Select Seat Fabric</p> <p>See page 372</p> <p><i>Specify for multi-fabric model only</i></p> | <p>Select Frame Fabric</p> <p>See page 372</p> <p><i>Specify for multi-fabric model only</i></p> | <p>Select Base and Base Color</p> <p>See page 372</p> <p>4S 4-Star Return-to-Center 5S 5-Star w/Swivel Knee Tilt, Hard Caster (+ \$25) 5SS 5-Star w/Swivel Knee Tilt, All-Surface Caster (+ \$55) WD Wood (+ \$250)</p> |
| HMAVHNMF | PURL05 | PURL05 | PURL03 | 4SP7A |



HMAVHA



HIGH-BACK SINGLE LOUNGE, ARMS

DIMENSIONS

| | | | |
|--------------------------------|--------|-----------------------|----------|
| Depth: | 30¼ | Back Height: | 32½ |
| Height (4-Star): | 43½ | Back Width: | 20 |
| Height (5-Star): | 47-50¾ | Arm Height: | 8½ |
| Height (Wood): | 44 | Ship Weight: | 59 |
| Width: | 25 | Ship Weight (5-Star): | 67 |
| Usable Seat Depth: | 19 | Cube: | 29 |
| Seat to Floor Height: | 17¾ | COM: | 5.0 |
| Seat to Floor Height (5-Star): | 17¼-21 | Weight Rating: | 300 lbs. |
| Seat Width: | 21 | | |

FABRIC PRICE CODES

| | | | |
|----------|---------------|-----------|---------------|
| 1 | \$2014 | 8 | \$2739 |
| 2 | \$2110 | 9 | \$2757 |
| 3 | \$2208 | 10 | \$2855 |
| 4 | \$2289 | 11 | \$2953 |
| 5 | \$2398 | 12 | \$3051 |
| 6 | \$2509 | L | \$3736 |
| 7 | \$2623 | | |

HMAVHAMF



HIGH-BACK SINGLE LOUNGE, ARMS, MULTI-FABRIC

DIMENSIONS

| | | | |
|--------------------------------|--------|-----------------------|----------|
| Depth: | 30¼ | Back Height: | 32½ |
| Height (4-Star): | 43½ | Back Width: | 20 |
| Height (5-Star): | 47-50¾ | Arm Height: | 8½ |
| Height (Wood): | 44 | Ship Weight: | 59 |
| Width: | 25 | Ship Weight (5-Star): | 67 |
| Usable Seat Depth: | 19 | Cube: | 29 |
| Seat to Floor Height: | 17¾ | COM (Seat Cushion): | 1.5 |
| Seat to Floor Height (5-Star): | 17¼-21 | COM (Back/Frame): | 4.0 |
| Seat Width: | 21 | Weight Rating: | 300 lbs. |

FABRIC PRICE CODES

| | | |
|-----------|--------------------------------|--------------|
| 1 | \$2173 | |
| | <i>Add to Base Price Above</i> | |
| | Seat | Frame |
| 2 | \$24 | \$72 |
| 3 | \$48 | \$145 |
| 4 | \$69 | \$206 |
| 5 | \$96 | \$288 |
| 6 | \$124 | \$371 |
| 7 | \$152 | \$457 |
| 8 | \$181 | \$544 |
| 9 | \$186 | \$557 |
| 10 | \$210 | \$631 |
| 11 | \$235 | \$704 |
| 12 | \$259 | \$778 |

HON Recommendation: HMAVHAMF.PURL__PURL__4S__ - List Price \$2366

HOW TO SPECIFY

| | | | | |
|--|---|--|---|---|
| <p>Select Model Number</p> <p>See page 372</p> <p><i>Specify for single fabric model only</i></p> | <p>Select Fabric</p> <p>See page 372</p> <p><i>Specify for multi-fabric model only</i></p> | <p>Select Seat Fabric</p> <p>See page 372</p> <p><i>Specify for multi-fabric model only</i></p> | <p>Select Frame Fabric</p> <p>See page 372</p> <p><i>Specify for multi-fabric model only</i></p> | <p>Select Base and Base Color</p> <p>See page 372</p> <p>4S 4-Star Return-to-Center 5S 5-Star w/Swivel Knee Tilt, Hard Caster (+ \$25) 5SS 5-Star w/Swivel Knee Tilt, All-Surface Caster (+ \$55) WD Wood (+ \$250)</p> |
| HMAVHAMF . | PURL05 . | PURL05 . | PURL03 . | 4SP7A |



HMAVO



SINGLE LOUNGE OTTOMAN

DIMENSIONS

| | | | |
|-----------------------|----|----------------|----------|
| Depth: | 22 | Ship Weight: | 33 |
| Height: | 15 | Cube: | 9.5 |
| Width: | 24 | COM: | 3.5 |
| Usable Seat Depth: | 24 | Weight Rating: | 300 lbs. |
| Seat to Floor Height: | 15 | | |
| Seat Width: | 22 | | |

FABRIC PRICE CODES

| | | | |
|---|--------|----|--------|
| 1 | \$901 | 8 | \$1626 |
| 2 | \$997 | 9 | \$1644 |
| 3 | \$1095 | 10 | \$1742 |
| 4 | \$1176 | 11 | \$1840 |
| 5 | \$1285 | 12 | \$1938 |
| 6 | \$1396 | L | \$2623 |
| 7 | \$1510 | | |

HMAVOMF



SINGLE LOUNGE OTTOMAN, MULTI-FABRIC

DIMENSIONS

| | | | |
|-----------------------|----|---------------------|----------|
| Depth: | 22 | Ship Weight: | 33 |
| Height: | 15 | Cube: | 9.5 |
| Width: | 24 | COM (Seat Cushion): | 1.5 |
| Usable Seat Depth: | 24 | COM (Frame): | 2.5 |
| Seat to Floor Height: | 15 | Weight Rating: | 300 lbs. |
| Seat Width: | 22 | | |

FABRIC PRICE CODES

| | | | |
|--------------------------------|-------------|--------------|--|
| 1 | \$981 | | |
| <i>Add to Base Price Above</i> | | | |
| | Seat | Frame | |
| 2 | \$24 | \$72 | |
| 3 | \$48 | \$145 | |
| 4 | \$69 | \$206 | |
| 5 | \$96 | \$288 | |
| 6 | \$124 | \$371 | |
| 7 | \$152 | \$457 | |
| 8 | \$181 | \$544 | |
| 9 | \$186 | \$557 | |
| 10 | \$210 | \$631 | |
| 11 | \$235 | \$704 | |
| 12 | \$259 | \$778 | |

HON Recommendation: HMAVOMF.PURL___.PURL___.4S__ - List Price \$1174

HOW TO SPECIFY

| | | | | |
|--|--|--|---|---|
| <p>Select Model Number</p> <p>HMAVOMF .</p> | <p>Select Fabric</p> <p>See page 372 Specify for single fabric model only</p> <p>PURL05 .</p> | <p>Select Seat Fabric</p> <p>See page 372 Specify for multi-fabric model only</p> <p>PURL05 .</p> | <p>Select Frame Fabric</p> <p>See page 372 Specify for multi-fabric model only</p> <p>PURL03 .</p> | <p>Select Base and Base Color</p> <p>See page 372 4S 4-Star</p> <p>4SP7A</p> |
|--|--|--|---|---|



Merit™ Executive Conference
Chair with Voi® Desks.

MERIT™

Merit™ is the answer for anyone who wants the experience of sitting in a refined executive chair combined with the sleek look of a European conference chair. A channel stitched back and polished aluminum arm and base accents provide the initial attraction, but the supreme comfort of the weight-activated control makes them stay. This modern, streamlined look is complemented by a luxurious sitting experience.



FEATURES

- Weight-activated tilt-control mechanism provides natural, ergonomic reclining position.
- Leather wrapped back includes channel stitching for upscale look. Available in Black or Gray.
- Color-matched soft arm cap.
- Pneumatic seat height adjustment.
- Molded foam seat and back.
- Padded headrest.
- Weight rating of 275 lbs.



Executive Conference Chair

HME3



EXECUTIVE CONFERENCE CHAIR

Pneumatic
Swivel
Weight-activated Control
Tilt Lock
Fixed Arms

Functions: **A, E, F, L, T**
(Function Key on pages 212-213)

DIMENSIONS

| | | | |
|--------------|-----|-----------------------|----------|
| Depth: | 27¼ | Arm Width: | 20½ |
| Width: | 27¼ | Seat to Floor Height: | 18-21 |
| Height: | 49¾ | Usable Seat Depth: | 20 |
| Seat Depth: | 20 | Ship Weight: | 47.5 |
| Seat Width: | 20½ | Cube: | 14.3 |
| Back Width: | 19 | Weight Rating: | 275 lbs. |
| Back Height: | 29¼ | | |

LIST PRICE

Leather \$1159

NOTES: Black or Gray leather options. Detailed channel stitching on back. Polished arms and base. Fixed arms with color-matched soft arm cap.

HON Recommendation: HME3.W5.P.H.LR58.PA - List Price \$1159

HOW TO SPECIFY

| | | | | | |
|---|--|--|--|---|---|
| <p>Select Model Number</p> <p>HME3</p> | <p>Select Control Type</p> <p>W5 Weight-Activated</p> | <p>Select Arm Type</p> <p>P Fixed Arms - Polished</p> | <p>Select Caster</p> <p>H Black Hard Caster</p> | <p>Select Fabric</p> <p>LR58 Black Leather LR29 Gray Leather</p> | <p>Select Base</p> <p>PA Polished Aluminum</p> |
|---|--|--|--|---|---|

MOTIVATE® CHAIRS

Want to see more? Scan here
to check out hon.com.



Motivate® 4-Leg Stacking Chairs and Between™ Table.

MOTIVATE® CHAIRS

A presentation in the morning. A training session in the afternoon. Today's multi-purpose spaces are in constant flux, and need an adaptable seating solution that delivers instant comfort for all, while easily moving around to support various activities. Motivate task chairs, stacking/nesting chairs and guest chairs create a streamlined collection of seating that intuitively responds to your body's natural movements and curves. Whether sitting for five minutes or five hours, when you Motivate your team you put everyone at ease.



FEATURES

- Choose plastic, upholstered or 4-Way Stretch mesh back.
- Easily move chairs around the space for quick rearrangement.
- HMN1 nesting/stacking chairs stack four high on the floor.
- HMS1 sled base chairs stack 12 high on the floor or 40 high on a cart.
- HMS2 sled base chairs stack six high on the floor.
- Dynamic flex-zone motion in seat and back provides balance and lumbar support.
- Model HMT5 task stool features an adjustable footring.
- Plastic shell is available in 13 colors.
- Available in hundreds of quality HON fabrics.
- Warranted for users up to 300 lbs.

TASK CHAIR FEATURES

- One-touch seat height adjustment easily moves the seat up and down.
- 360-degree swivel provides freedom of movement in any direction.
- Warranted for users up to 300 lbs.

MOTIVATE® Task Chair Options

MODEL OPTIONS

HMT1



Flex-back

Upholstered Seat,
Pneumatic, Swivel

HMT5



Flex-back

Upholstered Seat,
Pneumatic, Swivel
Adjustable Footring

ARM STYLE

| CODE | DESCRIPTION | PRICE |
|----------|-----------------|--------------|
| N | Armless | +\$0 |
| A | Adjustable Arms | +\$70 |



CASTERS

| CODE | DESCRIPTION | PRICE |
|----------|--------------------|--------------|
| H | Hard Caster | +\$0 |
| S | All-Surface Caster | +\$40 |



BACK STYLE

| CODE | DESCRIPTION | PRICE |
|------|-------------|-------|
|------|-------------|-------|

Plastic/Upholstered Options:



| | | |
|-----------|---------------|-------------|
| PS | Plastic Shell | +\$0 |
|-----------|---------------|-------------|



| | | |
|-----------|-------------|--------------|
| PB | Upholstered | +\$70 |
|-----------|-------------|--------------|

4-Way Stretch Options:



| | | |
|-----------|------------|--------------|
| IM | Black | +\$80 |
| IB | Breeze | +\$80 |
| IK | Brownstone | +\$80 |
| IC | Charcoal | +\$80 |
| IF | Fog | +\$80 |
| IR | Regatta | +\$80 |
| IT | Titanium | +\$80 |

| PLASTIC SHELL COLOR CODES (no upcharge): | Tangelo - RG | Cherry - CR | Lime - LM | Calypso - CP | Surf - BU |
|--|---------------------|----------------------|-------------------|----------------------|--------------------|
| | Regatta - RE | Mulberry - MB | Loft - LO | Platinum - PT | Shadow - SD |
| | Lava - LA | Onyx - ON | White - WT | | |

BASE



| CODE | DESCRIPTION | PRICE |
|-----------|---------------|-------------|
| SB | Standard Base | +\$0 |

FRAME COLOR

| CODE | DESCRIPTION | PRICE |
|----------|-------------|-------------|
| T | Black | +\$0 |

SEATING

MOTIVATE®

Task Chair Fabric Options

HON BRANDED FABRICS

| GRADE 1 | GRADE 2 | GRADE 3 | GRADE L |
|------------|-----------------|-----------|----------------|
| Apex | Appoint Seating | In Season | Denver Leather |
| Attire | Blume | Moxie | |
| Centurion | Clyde | Parker | |
| Compass | Dotty | Purl | |
| Contourett | Rush | Quill | |
| Dapper | Seed | | |
| Ensemble | Spin Seating | | |
| Hamilton | Whisper Vinyl | | |
| Inertia | | | |
| Optic | | | |
| Pebble | | | |

For a complete list of fabrics, including partnership fabrics, go to hon.com/fabricsandfinishes.

Reference Fabric Color Combinations on pages 18-22 for color codes and legend on page 19 for lead times.



Icon Legend on page 17

MOTIVATE® Task Chairs

HMT1

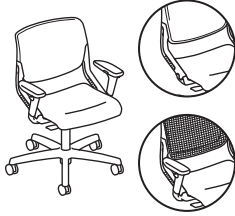

TASK CHAIR

Flex-back
Upholstered Seat
Pneumatic
Swivel

DIMENSIONS

| | | | |
|--------------|--------|----------------------------------|----------|
| Depth: | 27½ | Seat to Floor Height: | 17-22½ |
| Width: | 27½ | Usable Seat Depth: | 18 |
| Height: | 37½ | Ship Weight (upholstered back): | 39 |
| Seat Depth: | 18 | Ship Weight (plastic/mesh back): | 38 |
| Seat Width: | 17½ | Cube (upholstered back): | 10.0 |
| Back Width: | 19½ | Cube (plastic/mesh back): | 10.0 |
| Back Height: | 17¾ | COM (upholstered back): | 1.5 |
| Arm Width: | 18½-20 | COM (plastic/mesh back): | 1.0 |
| | | Weight Rating: | 300 lbs. |

FABRIC PRICE CODES

| | | | |
|----------|--------------|-----------|--------------|
| 1 | \$493 | 8 | \$700 |
| 2 | \$529 | 9 | \$727 |
| 3 | \$565 | 10 | \$754 |
| 4 | \$592 | 11 | \$781 |
| 5 | \$619 | 12 | \$808 |
| 6 | \$646 | L | — |
| 7 | \$673 | | |

❗ When a Plastic Shell (PS) or Upholstered Back (PB) option is chosen, you must select a shell color. If the mesh back option is chosen, the shell color is not specified.

HMT5

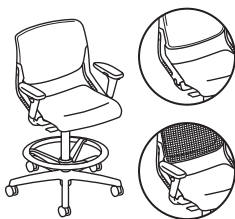

TASK STOOL

Flex-back
Upholstered Seat
Pneumatic
Swivel Adjustable Footring

DIMENSIONS

| | | | |
|--------------|--------|----------------------------------|----------|
| Depth: | 28¼ | Seat to Floor Height: | 22½-32½ |
| Width: | 28¼ | Usable Seat Depth: | 18 |
| Height: | 50½ | Ship Weight (upholstered back): | 44 |
| Seat Depth: | 18 | Ship Weight (plastic/mesh back): | 43 |
| Seat Width: | 17½ | Cube (upholstered back): | 10.0 |
| Back Width: | 19½ | Cube (plastic/mesh back): | 10.0 |
| Back Height: | 17¾ | COM (upholstered back): | 1.5 |
| Arm Width: | 18½-20 | COM (plastic/mesh back): | 1.0 |
| | | Weight Rating: | 300 lbs. |

FABRIC PRICE CODES

| | | | |
|----------|--------------|-----------|--------------|
| 1 | \$560 | 8 | \$767 |
| 2 | \$596 | 9 | \$794 |
| 3 | \$632 | 10 | \$821 |
| 4 | \$659 | 11 | \$848 |
| 5 | \$686 | 12 | \$875 |
| 6 | \$713 | L | — |
| 7 | \$740 | | |

NOTES: Stool model has adjustable footring.

❗ When a Plastic Shell (PS) or Upholstered Back (PB) option is chosen, you must select a shell color. If the mesh back option is chosen, the shell color is not specified.

HON Recommendation: HMT1.A.H.IM.CU__SB.T - List Price \$643

HOW TO SPECIFY

| Select Model Number | Select Arm Type | Select Caster | Select Back Type/Color | Select Fabric | Select Base | Select Frame |
|---|--|--|------------------------|------------------|-------------|--------------|
| A Adjustable Arms (+ \$70) N Armless | H Hard Caster S All-Surface Caster (+ \$40) | PS Plastic Shell PB Upholstered (+ \$70) If PS or PB options are chosen, select shell color. Plastic Shell Colors RG Tangelo LO Loft CR Cherry PT Platinum LM Lime SD Shadow CP Calypso LA Lava BU Surf ON Onyx RE Regatta WT White MB Mulberry 4-Way Stretch options (+ \$80) IM Black IF Fog IB Breeze IR Regatta IK Brownstone IT Titanium IC Charcoal | See page 382 | SB Standard Base | T Black | |
| HMT1 | A | H | IM | CU10 | SB | T |
| HMT1 | A | H | PSLA | CU10 | SB | T |

SEATING

MOTIVATE® High-Density Sled Base Chair Options

MODEL OPTIONS

HMS1



High-Density Stacker

Sled Leg Base

HMS2



High-Density Stacker

Upholstered Seat, Sled Leg Base

ARM STYLE

| CODE | DESCRIPTION | PRICE |
|----------|-------------|--------------|
| F | Fixed Arms | +\$30 |
| N | Armless | +\$0 |



FRAME

| CODE | DESCRIPTION | PRICE |
|------------------|----------------------------|--------------|
| Y | Chrome | +\$0 |
| P1 PAINT: | | +\$0 |
| BLCK | Textured Black Mica | |
| P7J | Textured Brownstone | |
| P7A | Textured Charcoal | |
| PK7 | Textured Designer White | |
| P7L | Textured Loft | |
| P7M | Textured Muslin | |
| PLAT | Textured Platinum Metallic | |
| P8V | Textured Titanium | |
| P2 PAINT: | | +\$0 |
| PR8 | Textured Silver | |
| P3 PAINT: | | +\$30 |
| P8S | Atom | |
| PJF | Bullseye | |
| P8P | Ember | |
| P8N | Ion | |
| P8J | Iris | |
| P8F | Krypton | |
| P8M | Regatta | |

PLASTIC SHELL COLOR CODES (no upcharge):

| | | | | |
|---------------------|----------------------|-------------------|----------------------|--------------------|
| Tangelo - RG | Cherry - CR | Lime - LM | Calypso - CP | Surf - BU |
| Regatta - RE | Mulberry - MB | Loft - LO | Platinum - PT | Shadow - SD |
| Lava - LA | Onyx - ON | White - WT | | |

HON BRANDED FABRICS

| GRADE 1 | GRADE 2 | GRADE 3 |
|------------|-----------------|-----------|
| Apex | Appoint Seating | In Season |
| Attire | Blume | Parker |
| Centurion | Clyde | Purl |
| Compass | Dotty | Quill |
| Contourett | Rush | |
| Dapper | Seed | |
| Ensemble | Spin Seating | |
| Hamilton | Whisper Vinyl | |
| Inertia | | |
| Optic | | |
| Pebble | | |

For a complete list of fabrics, including partnership fabrics, go to hon.com/fabricsandfinishes.

Reference Fabric Color Combinations on pages 18-22 for color codes and legend on page 19 for lead times.



MOTIVATE® High-Density Sled Base Chairs

HMS1

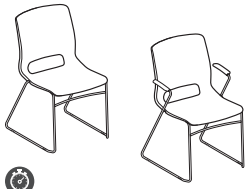

HIGH-DENSITY STACKER

Sled Leg Base

DIMENSIONS

| | | | |
|--------------|------------------|-----------------------|------------------|
| Depth: | 23 | Arm Width: | 18 $\frac{1}{8}$ |
| Width: | 21 | Seat to Floor Height: | 17 $\frac{3}{4}$ |
| Height: | 32 $\frac{1}{4}$ | Usable Seat Depth: | 18 $\frac{1}{4}$ |
| Seat Depth: | 18 $\frac{1}{4}$ | Ship Weight: | 72 |
| Seat Width: | 17 $\frac{3}{4}$ | Cube: | 15.2 |
| Back Width: | 17 $\frac{1}{4}$ | Weight Rating: | 300 lbs. |
| Back Height: | 18 | | |

LIST PRICE PER CARTON

\$941

(reference single unit @
\$235.25)

NOTES: HMS1 Sled Base chairs stack 12-high on the floor, or 40-high on the chair cart model HMSCART. Field installed glides snap-on using existing locations on the sled base frames.

- ❗ Ganging Chair Glides are designed for use on armless models of the Motivate® High-Density Sled Base Chairs only. Not for use on models specified with arms.
- 📦 Ships four (4) chairs per carton.

HMS2

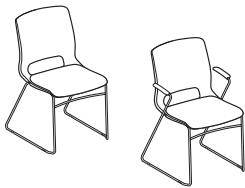

HIGH-DENSITY STACKER

Upholstered Seat
Sled Leg Base
Set of 4

DIMENSIONS

| | | | |
|--------------|------------------|-----------------------|------------------|
| Depth: | 23 | Arm Width: | 18 $\frac{1}{8}$ |
| Width: | 21 | Seat to Floor Height: | 18 $\frac{1}{4}$ |
| Height: | 32 $\frac{1}{4}$ | Usable Seat Depth: | 18 $\frac{1}{4}$ |
| Seat Depth: | 18 $\frac{1}{4}$ | Ship Weight: | 80 |
| Seat Width: | 17 $\frac{3}{4}$ | Cube: | 15.2 |
| Back Width: | 17 $\frac{1}{4}$ | COM (per 4 pack): | 1.6 |
| Back Height: | 17 $\frac{1}{2}$ | Weight Rating: | 300 lbs. |

FABRIC PRICE CODES

| | | | |
|----------|---------------|-----------|---------------|
| 1 | \$1206 | 8 | \$1344 |
| 2 | \$1230 | 9 | \$1362 |
| 3 | \$1254 | 10 | \$1380 |
| 4 | \$1272 | 11 | \$1398 |
| 5 | \$1290 | 12 | \$1416 |
| 6 | \$1308 | L | — |
| 7 | \$1326 | | |

NOTES: HMS2 Sled Base chairs stack 6-high on the floor. Field installed glides snap-on using existing locations on the sled base frames.

- ❗ Ganging Chair Glides are designed for use on armless models of the Motivate® High-Density Sled Base Chairs only. Not for use on models specified with arms. Upholstered seat model HMS2 is not designed to be stacked on the HMSCART.
- 📦 Motivate® Sled Base Chairs are ordered and shipped four (4) chairs per carton. Pricing shown is per carton. Each set of four chairs (one carton), must have the same shell/frame color combination. Ordering 2 of Model HMS1, HMS2 will result in 2 cartons being shipped, giving you 8 chairs.

HMSCART

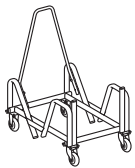

CART FOR HMS1 STACKING CHAIRS

DIMENSIONS

| | | | |
|---------|------------------|--------------|-----|
| Depth: | 34 $\frac{1}{4}$ | Ship Weight: | 40 |
| Width: | 21 $\frac{3}{8}$ | Cube: | 7.8 |
| Height: | 36 $\frac{3}{8}$ | | |

LIST PRICE

\$540

NOTES: Holds up to 40 Stacking Chairs.

HON Recommendation: HMS1.N.ON.Y - List Price \$887

HOW TO SPECIFY

| | | | | |
|---|---|---|--|--|
| <p>Select Model Number</p> <p>HMS1 .</p> <p>HMS2 .</p> | <p>Select Arm Type</p> <p>F Fixed Arms (+ \$30 per chair)</p> <p>N Armless</p> <p>N .</p> <p>N .</p> | <p>Select Shell Color</p> <p>RG Tangelo LO Loft</p> <p>CR Cherry PT Platinum</p> <p>LM Lime SD Shadow</p> <p>CP Calypso LA Lava</p> <p>BU Surf ON Onyx</p> <p>RE Regatta WT White</p> <p>MB Mulberry</p> <p>ON .</p> <p>ON .</p> | <p>Select Fabric</p> <p>See page 384</p> <p>Not specified for HMS1 models</p> <p>CU10 .</p> | <p>Select Frame</p> <p>See page 384</p> <p>BLCK</p> <p>BLCK</p> |
|---|---|---|--|--|

SEATING

MOTIVATE® High-Density Sled Base Chairs

OPEN MARKET



Icon Legend on page 17

HMSGLD

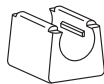

GLIDES FOR MOTIVATE® HIGH-DENSITY STACKER

- Kit includes 48 glides for 12 chairs
- Field installed
- Snap-on using existing locations on frames

DIMENSIONS

Ship Weight: 1
Cube: 0.2

LIST PRICE

\$72

HMSFLTGLD



FELT GLIDES FOR MOTIVATE® HIGH-DENSITY STACKER

- Kit includes 48 glides for 12 chairs
- Field installed
- Snap-on using existing locations on frames

DIMENSIONS

Ship Weight: 1
Cube: 0.2

LIST PRICE

\$183

HMSSTLGLD



STEEL GLIDES FOR MOTIVATE® HIGH-DENSITY STACKER

- Kit includes 48 glides for 12 chairs
- Field installed
- Snap-on using existing locations on frames

DIMENSIONS

Ship Weight: 1
Cube: 0.2

LIST PRICE

\$183

HMSGANG

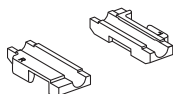

GANGING CONNECTORS FOR MOTIVATE® HIGH- DENSITY STACKER

- 48 ganging connectors
- Requires 4 connectors per ganging connection
- For use on HMS1.N and HMS2.N only (armless models)
- Field installed
- Snap-on using existing locations on frames

DIMENSIONS

Ship Weight: 1
Cube: 0.2

LIST PRICE

\$133

| Floor Covering | TYPE OF GLIDE | | |
|-----------------------------|---------------------|-----------------|-----------------|
| | Polycarbonate/Nylon | Felt | Steel |
| Carpet | Best | Not Recommended | Good |
| Polished concrete | Best | Good | Not Recommended |
| Hard wood | Not Recommended | Best | Not Recommended |
| Vinyl (includes LVT) | Best | Better | Good |
| VCT | Best | Good | Not Recommended |
| Tile (Porcelain/Ceramic) | Best | Good | Not Recommended |

HOW TO SPECIFY

Select
Model Number

H M S G L D

MOTIVATE® 4-Leg Chair Options

MODEL OPTIONS

HMG1



Stack Chair

Four Legs, Set of 2

HMG2



Stack Chair

Four Legs, Upholstered Seat, Set of 2

HMG3

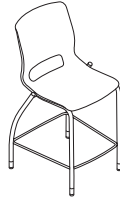

Counter-Height Stool

Four Legs

HMG4

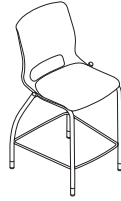

Counter-Height Stool

Four Legs, Upholstered Seat

HMG5



Café-Height Stool

Four Legs

HMG7



Café-Height Stool

Four Legs, Upholstered Seat

ARM STYLE



| CODE | DESCRIPTION | PRICE |
|----------|-------------|--------------|
| F | Fixed Arms | +\$30 |



| | | |
|----------|---------|-------------|
| N | Armless | +\$0 |
|----------|---------|-------------|

CASTERS/ GLIDES



| CODE | DESCRIPTION | PRICE |
|----------|-------------|-------------|
| H | Hard Caster | +\$0 |



| | | |
|----------|--------------------|--------------|
| S | All-Surface Caster | +\$30 |
|----------|--------------------|--------------|

**Casters only available on HMG1 and HMG2*



| | | |
|----------|----------------------|--------------|
| E | Standard Nylon Glide | +\$0 |
| F | Felt Glide | +\$30 |
| R | Rubber Glide | +\$30 |
| T | Steel Glide | +\$30 |

FRAME

| CODE | DESCRIPTION | PRICE |
|------------------|----------------------------|--------------|
| P1 PAINT: | | +\$0 |
| BLCK | Textured Black Mica | |
| P7J | Textured Brownstone | |
| P7A | Textured Charcoal | |
| PK7 | Textured Designer White | |
| P7L | Textured Loft | |
| P7M | Textured Muslin | |
| PLAT | Textured Platinum Metallic | |
| P8V | Textured Titanium | |
| P2 PAINT: | | +\$0 |
| PR8 | Textured Silver | |
| P3 PAINT: | | +\$30 |
| P8S | Atom | |
| PJF | Bullseye | |
| P8P | Ember | |
| P8N | Ion | |
| P8J | Iris | |
| P8F | Krypton | |
| P8M | Regatta | |

| PLASTIC SHELL COLOR CODES (no upcharge): | | | | |
|--|----------------------|-------------------|----------------------|--------------------|
| Tangelo - RG | Cherry - CR | Lime - LM | Calypso - CP | Surf - BU |
| Regatta - RE | Mulberry - MB | Loft - LO | Platinum - PT | Shadow - SD |
| Lava - LA | Onyx - ON | White - WT | | |

SEATING

MOTIVATE[®]

4-Leg Chair Fabric Options

HON BRANDED FABRICS

GRADE 1

Apex
Attire
Centurion
Compass
Contourett
Dapper
Ensemble
Hamilton
Inertia
Optic
Pebble

GRADE 2

Appoint Seating
Blume
Clyde
Dotty
Rush
Seed
Spin Seating
Whisper Vinyl

GRADE 3

In Season
Moxie
Parker
Purl
Quill

For a complete list of fabrics, including partnership fabrics, go to hon.com/fabricsandfinishes.

Reference Fabric Color Combinations on pages 18-22 for color codes and legend on page 19 for lead times.



MOTIVATE® 4-Leg Chairs

HMG1

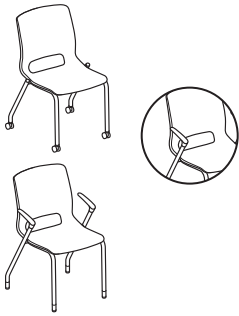

STACK CHAIR

Four Legs
Set of 2

DIMENSIONS

| | | | |
|--------------|-----|-----------------------|----------|
| Depth: | 23 | Arm Width: | 18 |
| Width: | 21 | Seat to Floor Height: | 17¾ |
| Height: | 32¼ | Usable Seat Depth: | 18¾ |
| Seat Depth: | 18¾ | Ship Weight: | 38 |
| Seat Width: | 17¾ | Cube: | 13.0 |
| Back Width: | 17¼ | Weight Rating: | 300 lbs. |
| Back Height: | 18 | | |

LIST PRICE PER CARTON

\$612
*(reference single unit @
\$306.00)*

NOTES: 4-Leg chairs stack 6-high on the floor.

Ships two (2) chairs per carton.

HMG2

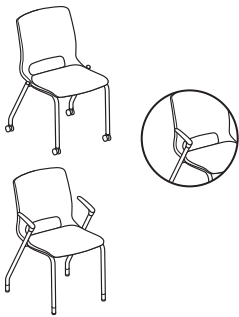

STACK CHAIR

Four Legs
Upholstered Seat
Set of 2

DIMENSIONS

| | | | |
|--------------|-----|-----------------------|----------|
| Depth: | 23 | Arm Width: | 18 |
| Width: | 21 | Seat to Floor Height: | 18¼ |
| Height: | 32¼ | Usable Seat Depth: | 18¾ |
| Seat Depth: | 18¾ | Ship Weight: | 44 |
| Seat Width: | 17¾ | Cube: | 13.0 |
| Back Width: | 17¼ | COM (per 2 pack): | 1.0 |
| Back Height: | 17½ | Weight Rating: | 300 lbs. |

FABRIC PRICE CODES

| | | | |
|----------|--------------|-----------|--------------|
| 1 | \$753 | 8 | \$891 |
| 2 | \$777 | 9 | \$909 |
| 3 | \$801 | 10 | \$927 |
| 4 | \$819 | 11 | \$945 |
| 5 | \$837 | 12 | \$963 |
| 6 | \$855 | L | — |
| 7 | \$873 | | |

NOTES: 4-Leg chairs stack 6-high on the floor.

Motivate® 4-leg Chairs are ordered and shipped two (2) chairs per carton. Pricing shown is per carton. Each set of two chairs (one carton), must have the same shell/frame color combination. Ordering 2 of Model HMG1, HMG2 will result in 2 cartons being shipped, giving you 4 chairs. 4-Leg chairs stack 6-high on the floor.

HON Recommendation: HMG1.N.H.ON.PLAT - List Price \$612

HOW TO SPECIFY

| Select Model Number | Select Arm Type | Select Caster/Glide | Select Shell Color | Select Fabric | Select Frame |
|---|--|---|---|---|--------------|
| F Fixed Arms (+ \$30 per chair) N Armless | H Hard Caster S All-Surface Caster (+ \$30 per chair) <i>Casters only available on HMG1 and HMG2</i> E Standard Nylon Glide F Felt Glide (+ \$30 per chair) R Rubber Glide (+ \$30 per chair) T Steel Glide (+ \$30 per chair) | RG Tangelo CR Cherry LM Lime CP Calypso BU Surf RE Regatta MB Mulberry | LO Loft PT Platinum SD Shadow LA Lava ON Onyx WT White | See page 388 <i>Not specified for models HMG1 and HMG5</i> | See page 387 |
| HMG1 . | N . | H . | ON . | | PLAT |
| HMG2 . | N . | H . | ON . | CU10 . | PLAT |

SEATING

MOTIVATE® 4-Leg Chairs

GSA SIN 33721



Icon Legend on page 17

HMG3

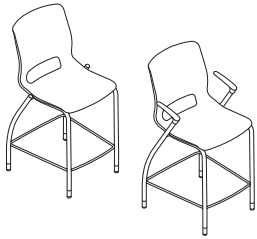

COUNTER-HEIGHT STOOL

Four Legs

DIMENSIONS

| | | | |
|--------------|-----|-----------------------|----------|
| Depth: | 23 | Arm Width: | 18 |
| Width: | 21 | Seat to Floor Height: | 24½ |
| Height: | 40½ | Usable Seat Depth: | 18½ |
| Seat Depth: | 18½ | Ship Weight: | 26 |
| Seat Width: | 17¾ | Cube: | 13.8 |
| Back Width: | 17¼ | Weight Rating: | 300 lbs. |
| Back Height: | 18 | | |

LIST PRICE

\$430

HMG4



COUNTER-HEIGHT STOOL

Four Legs
Upholstered Seat

DIMENSIONS

| | | | |
|--------------|-----|-----------------------|----------|
| Depth: | 23 | Arm Width: | 18 |
| Width: | 21 | Seat to Floor Height: | 25 |
| Height: | 40½ | Usable Seat Depth: | 18¼ |
| Seat Depth: | 18½ | Ship Weight: | 26 |
| Seat Width: | 17¾ | Cube: | 13.8 |
| Back Width: | 17¼ | COM: | 1.0 |
| Back Height: | 17½ | Weight Rating: | 300 lbs. |

FABRIC PRICE CODES

| | | | |
|----------|--------------|-----------|--------------|
| 1 | \$509 | 8 | \$647 |
| 2 | \$533 | 9 | \$665 |
| 3 | \$557 | 10 | \$683 |
| 4 | \$575 | 11 | \$701 |
| 5 | \$593 | 12 | \$719 |
| 6 | \$611 | L | — |
| 7 | \$629 | | |

HMG5

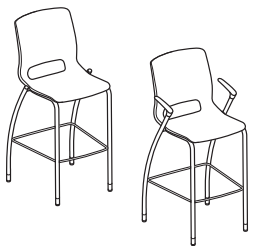

CAFÉ-HEIGHT STOOL

Four Legs

DIMENSIONS

| | | | |
|--------------|-----|-----------------------|----------|
| Depth: | 23 | Arm Width: | 18 |
| Width: | 21 | Seat to Floor Height: | 30 |
| Height: | 44½ | Usable Seat Depth: | 18½ |
| Seat Depth: | 18½ | Ship Weight: | 30 |
| Seat Width: | 17¾ | Cube: | 19.3 |
| Back Width: | 17¼ | Weight Rating: | 300 lbs. |
| Back Height: | 18 | | |

LIST PRICE

\$451

HMG7

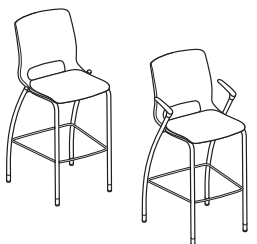

CAFÉ-HEIGHT STOOL

Four Legs
Upholstered Seat

DIMENSIONS

| | | | |
|--------------|-----|-----------------------|----------|
| Depth: | 23 | Arm Width: | 18 |
| Width: | 21 | Seat to Floor Height: | 30½ |
| Height: | 44½ | Usable Seat Depth: | 18¼ |
| Seat Depth: | 18½ | Ship Weight: | 34 |
| Seat Width: | 17¾ | Cube: | 19.3 |
| Back Width: | 17¼ | COM: | 1.0 |
| Back Height: | 17½ | Weight Rating: | 300 lbs. |

FABRIC PRICE CODES

| | | | |
|----------|--------------|-----------|--------------|
| 1 | \$535 | 8 | \$673 |
| 2 | \$559 | 9 | \$691 |
| 3 | \$583 | 10 | \$709 |
| 4 | \$601 | 11 | \$727 |
| 5 | \$619 | 12 | \$745 |
| 6 | \$637 | L | — |
| 7 | \$655 | | |

HON Recommendation: HMG5.N.E.ON.PLAT - List Price \$451

HOW TO SPECIFY

| Select Model Number | Select Arm Type | Select Glide | Select Shell Color | Select Fabric | Select Frame |
|---------------------|--|--|--|---|---|
| HMG5 | F Fixed Arms (+ \$30 per chair) N Armless | E Standard Nylon Glide F Felt Glide (+ \$30 per chair) R Rubber Glide (+ \$30 per chair) T Steel Glide (+ \$30 per chair) | RG Tangelo CR Cherry LM Lime CP Calypso BU Surf RE Regatta MB Mulberry | LO Loft PT Platinum SD Shadow LA Lava ON Onyx WT White | See page 388 <i>Not specified for models HMG1 and HMG5</i> |
| HMG7 | N | E | ON | CU10 | PLAT |

SEATING

MOTIVATE® Nesting/Stacking Flex-Back Chair Options

MODEL OPTIONS

HMN1



Flex-back

Nesting/Stacking,
Four Legs

HMN2



Flex-back

Nesting/Stacking, Four
Legs, Upholstered Seat

ARM STYLE

| CODE | DESCRIPTION | PRICE |
|----------|-------------|--------------|
| F | Fixed Arms | +\$50 |
| N | Armless | +\$0 |



CASTERS/ GLIDE



| CODE | DESCRIPTION | PRICE |
|----------|----------------------|--------------|
| H | Hard Caster | +\$0 |
| S | All-Surface Caster | +\$30 |
| E | Standard Nylon Glide | +\$0 |

BACK STYLE

| CODE | DESCRIPTION | PRICE |
|-------------------------------------|---------------|--------------|
| <i>Plastic/Upholstered Options:</i> | | |
| PS | Plastic Shell | +\$0 |
| PB | Upholstered | +\$70 |
| <i>*PB only available on HMN2</i> | | |
| <i>4-Way Stretch Options:</i> | | |
| IM | Black | +\$80 |
| IF | Fog | +\$80 |
| IC | Charcoal | +\$80 |



FRAME

| CODE | DESCRIPTION | PRICE |
|------------------|----------------------------|--------------|
| P1 PAINT: | | +\$0 |
| BLCK | Textured Black Mica | |
| P7J | Textured Brownstone | |
| P7A | Textured Charcoal | |
| PK7 | Textured Designer White | |
| P7L | Textured Loft | |
| P7M | Textured Muslin | |
| PLAT | Textured Platinum Metallic | |
| P8V | Textured Titanium | |
| P2 PAINT: | | +\$0 |
| PR8 | Textured Silver | |
| P3 PAINT: | | +\$30 |
| P8S | Atom | |
| PJF | Bullseye | |
| P8P | Ember | |
| P8N | Ion | |
| P8J | Iris | |
| P8F | Krypton | |
| P8M | Regatta | |

SEATING

| PLASTIC SHELL COLOR CODES (no upcharge): | | | | |
|--|----------------------|-------------------|----------------------|--------------------|
| Tangelo - RG | Cherry - CR | Lime - LM | Calypso - CP | Surf - BU |
| Regatta - RE | Mulberry - MB | Loft - LO | Platinum - PT | Shadow - SD |
| Lava - LA | Onyx - ON | White - WT | | |

MOTIVATE®

Nesting/Stacking Flex-Back Chair Fabric Options

HON BRANDED FABRICS

GRADE 1

Apex
Attire
Centurion
Compass
Contourett
Dapper
Ensemble
Hamilton
Inertia
Optic
Pebble

GRADE 2

Appoint Seating
Blume
Clyde
Dotty
Rush
Seed
Spin Seating
Whisper Vinyl

GRADE 3

In Season
Moxie
Parker
Purl
Quill

For a complete list of fabrics, including partnership fabrics, go to hon.com/fabricsandfinishes.

Reference Fabric Color Combinations on pages 18-22 for color codes and legend on page 19 for lead times.

 For Fire Code model, availability, and ordering method, refer to page 216. Available on select models, contact HON Customer Support for availability.

MOTIVATE® Nesting/Stacking Flex-Back Chairs

HMN1

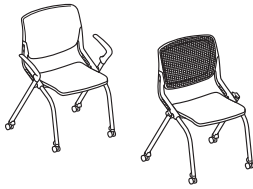

CHAIR

Flex-back
Nesting/Stacking
Four Legs

DIMENSIONS

| | | | |
|--------------|--------------------------------|-----------------------|--------------------------------|
| Depth: | 23 ³ / ₈ | Arm Width: | 24 |
| Width: | 26 ³ / ₄ | Seat to Floor Height: | 18 ¹ / ₄ |
| Height: | 34 | Usable Seat Depth: | 16 ³ / ₄ |
| Seat Depth: | 16 ³ / ₄ | Ship Weight: | 27 |
| Seat Width: | 17 | Cube: | 15.1 |
| Back Width: | 19 ¹ / ₂ | Weight Rating: | 300 lbs. |
| Back Height: | 19 | | |

LIST PRICE

\$512

NOTES: Stack 4-high on floor.

! When selecting the mesh back option, seat shell will be in the specified shell color chosen but the frame around the mesh will always be black.

HMN2



CHAIR

Flex-back
Nesting/Stacking
Four Legs
Upholstered Seat

DIMENSIONS

| | | | |
|--------------|--------------------------------|----------------------------------|--------------------------------|
| Depth: | 23 ³ / ₈ | Seat to Floor Height: | 19 ¹ / ₄ |
| Width: | 26 ³ / ₄ | Usable Seat Depth: | 17 |
| Height: | 34 | Ship Weight (upholstered back): | 29 |
| Seat Depth: | 17 | Ship Weight (plastic/mesh back): | 28 |
| Seat Width: | 17 ³ / ₈ | Cube (upholstered back): | 15.1 |
| Back Width: | 19 ¹ / ₂ | Cube (plastic/mesh back): | 15.1 |
| Back Height: | 18 ³ / ₈ | COM (upholstered back): | 1.0 |
| Arm Width: | 24 | COM (plastic/mesh back): | 1.0 |
| | | Weight Rating: | 300 lbs. |

FABRIC PRICE CODES

| | | | |
|----------|--------------|-----------|--------------|
| 1 | \$583 | 8 | \$721 |
| 2 | \$607 | 9 | \$739 |
| 3 | \$631 | 10 | \$757 |
| 4 | \$649 | 11 | \$775 |
| 5 | \$667 | 12 | \$793 |
| 6 | \$685 | L | — |
| 7 | \$703 | | |

NOTES: Stack 4-high on floor.

! When selecting the mesh back option, seat shell will be in the specified shell color chosen but the frame around the mesh will always be black.

HON Recommendation: HMN1.N.H.IM.ON.CU__PLAT - List Price \$592

HOW TO SPECIFY

| Select Model Number | Select Arm Type | Select Caster/Glide | Select Back Type | Select Shell Color | Select Fabric | Select Frame |
|---|---|--|--|---|---------------------|-------------------------|
| <p>F Fixed Arms (+ \$50)</p> <p>N Armless</p> | <p>E Standard Nylon Glide</p> <p>H Hard Caster</p> <p>S All-Surface Caster (+ \$30)</p> | <p>PS Plastic Shell</p> <p>PB Upholstered (+ \$70)</p> <p><i>PB option available on HMN2 only</i></p> <p>4-Way Stretch options (+ \$80)</p> <p>IM Black</p> <p>IF Fog</p> <p>IC Charcoal</p> | <p>RG Tangelo</p> <p>CR Cherry</p> <p>LM Lime</p> <p>CP Calypso</p> <p>BU Surf</p> <p>RE Regatta</p> <p>MB Mulberry</p> <p>LO Loft</p> <p>PT Platinum</p> <p>SD Shadow</p> <p>LA Lava</p> <p>ON Onyx</p> <p>WT White</p> | <p>See page 392</p> <p><i>Specify for model HMN2 only</i></p> | <p>See page 391</p> | |
| <p>HMN1</p> <p>HMN2</p> | <p>N</p> <p>N</p> | <p>H</p> <p>H</p> | <p>IM</p> <p>PB</p> | <p>ON</p> <p>ON</p> | <p>CU10</p> | <p>PLAT</p> <p>PLAT</p> |

MOTIVATE® Chair with Tablet Arm Options

MODEL OPTIONS

HMG1



with Tablet Arm

Four Legs

HMG2



with Tablet Arm

Four Legs, Upholstered Seat

CASTERS/ GLIDES



| CODE | DESCRIPTION | PRICE |
|----------|-------------|-------------|
| H | Hard Caster | +\$0 |



| | | |
|----------|--------------------|--------------|
| S | All-Surface Caster | +\$30 |
|----------|--------------------|--------------|



| | | |
|----------|----------------------|--------------|
| E | Standard Nylon Glide | +\$0 |
| F | Felt Glide | +\$30 |
| R | Rubber Glide | +\$30 |
| T | Steel Glide | +\$30 |

TABLET SIDE



| CODE | DESCRIPTION | PRICE |
|-----------|-------------|-------------|
| RT | Right Side | +\$0 |
| LT | Left Side | +\$0 |



TABLET COLOR

| CODE | DESCRIPTION | PRICE |
|----------|---------------|-------------|
| T | Black | +\$0 |
| D | Natural Maple | +\$0 |

FRAME

| CODE | DESCRIPTION | PRICE |
|------------------|----------------------------|--------------|
| P1 PAINT: | | +\$0 |
| BLCK | Textured Black Mica | |
| P7J | Textured Brownstone | |
| P7A | Textured Charcoal | |
| PK7 | Textured Designer White | |
| P7L | Textured Loft | |
| P7M | Textured Muslin | |
| PLAT | Textured Platinum Metallic | |
| P8V | Textured Titanium | |
| P2 PAINT: | | +\$0 |
| PR8 | Textured Silver | |
| P3 PAINT: | | +\$30 |
| P8S | Atom | |
| PJF | Bullseye | |
| P8P | Ember | |
| P8N | Ion | |
| P8J | Iris | |
| P8F | Krypton | |
| P8M | Regatta | |

PLASTIC SHELL COLOR CODES (no upcharge):

Tangelo - **RG**
Regatta - **RE**
Lava - **LA**

Cherry - **CR**
Mulberry - **MB**
Onyx - **ON**

Lime - **LM**
Loft - **LO**
White - **WT**

Calypso - **CP**
Platinum - **PT**

Surf - **BU**
Shadow - **SD**

MOTIVATE[®]

Chair with Tablet Arm Fabric Options

HON BRANDED FABRICS

GRADE 1

Apex
Attire
Centurion
Compass
Contourett
Dapper
Ensemble
Hamilton
Inertia
Optic
Pebble

GRADE 2

Appoint Seating
Blume
Clyde
Dotty
Rush
Seed
Spin Seating
Whisper Vinyl

GRADE 3

In Season
Moxie
Parker
Purl
Quill

For a complete list of fabrics, including partnership fabrics, go to hon.com/fabricsandfinishes.

Reference Fabric Color Combinations on pages 18-22 for color codes and legend on page 19 for lead times.

MOTIVATE® Chair with Tablet Arm

GSA SIN 33721



Icon Legend on page 17

HMGT1

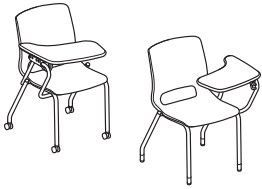

CHAIR

with Tablet Arm
Four Legs

DIMENSIONS

| | | | |
|-------------|-----|---------------------------|----------|
| Depth: | 30 | Back Width: | 17¼ |
| Width: | 21 | Back Height: | 18 |
| Height: | 32¼ | Seat to Floor Height: | 17¾ |
| Seat Depth: | 18¼ | Tablet Height from Floor: | 28¾ |
| Seat Width: | 17¾ | Ship Weight: | 41 |
| | | Cube: | 18.4 |
| | | Weight Rating: | 300 lbs. |

LIST PRICE PER CARTON

\$587

NOTES: Tablet can be specified on right or left side.

HMGT2

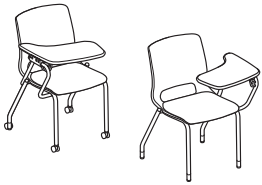

CHAIR

with Tablet Arm
Four Legs
Upholstered Seat

DIMENSIONS

| | | | |
|-------------|-----|---------------------------|----------|
| Depth: | 30 | Back Width: | 17¼ |
| Width: | 21 | Back Height: | 17½ |
| Height: | 32¼ | Seat to Floor Height: | 18¼ |
| Seat Depth: | 18¼ | Tablet Height from Floor: | 28¾ |
| Seat Width: | 17¾ | Ship Weight: | 43 |
| | | Cube: | 18.4 |
| | | Weight Rating: | 300 lbs. |

FABRIC PRICE CODES

| | | | |
|----------|--------------|-----------|--------------|
| 1 | \$668 | 8 | \$806 |
| 2 | \$692 | 9 | \$824 |
| 3 | \$716 | 10 | \$842 |
| 4 | \$734 | 11 | \$860 |
| 5 | \$752 | 12 | \$878 |
| 6 | \$770 | L | — |
| 7 | \$788 | | |

NOTES: Tablet can be specified on right or left side.

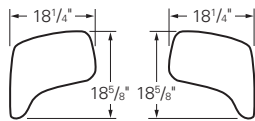

HON Recommendation: HMGT1.E.ON.RT.D.PLAT - List Price \$587

HOW TO SPECIFY

| Select Model Number | Select Caster/Glide | Select Shell Color | Select Fabric | Select Tablet Side | Select Tablet Color | Select Frame |
|----------------------------|--|---|---|-------------------------------|----------------------------|--------------|
| H S E F R T | H Hard Caster S All-Surface Caster (+ \$30 per chair) E Standard Nylon Glide F Felt Glide (+ \$30 per chair) R Rubber Glide (+ \$30 per chair) T Steel Glide (+ \$30 per chair) | RG Tangelo CR Cherry LM Lime CP Calypso BU Surf RE Regatta MB Mulberry LO Loft PT Platinum SD Shadow LA Lava ON Onyx WT White | See page 395 <i>Not specified for HMGT1 models</i> | RT Right Side LT Left Side | T Black D Natural Maple | See page 394 |
| HMGT1 | E | ON | | RT | D | PLAT |
| HMGT2 | E | ON | CU10 | RT | D | PLAT |

MOTIVATE® Flex-Back Chair with Tablet Arm Options

MODEL OPTIONS

HMNT1



Flex-back with Tablet Arm

HMNT2



Flex-back with Tablet Arm
Upholstered Seat

CASTERS/ GLIDE



| CODE | DESCRIPTION | PRICE |
|----------|-------------|-------------|
| H | Hard Caster | +\$0 |



| | | |
|----------|--------------------|--------------|
| S | All-Surface Caster | +\$30 |
|----------|--------------------|--------------|



| | | |
|----------|----------------------|-------------|
| E | Standard Nylon Glide | +\$0 |
|----------|----------------------|-------------|

BACK STYLE

| CODE | DESCRIPTION | PRICE |
|------|-------------|-------|
|------|-------------|-------|

Plastic/Upholstered Options:



| | | |
|-----------|---------------|-------------|
| PS | Plastic Shell | +\$0 |
|-----------|---------------|-------------|



| | | |
|-----------|-------------|--------------|
| PB | Upholstered | +\$70 |
|-----------|-------------|--------------|

4-Way Stretch Options:



| | | |
|-----------|----------|--------------|
| IM | Black | +\$80 |
| IF | Fog | +\$80 |
| IC | Charcoal | +\$80 |

TABLET SIDE



| CODE | DESCRIPTION | PRICE |
|-----------|-------------|-------------|
| RT | Right Side | +\$0 |
| LT | Left Side | +\$0 |



TABLET COLOR

| CODE | DESCRIPTION | PRICE |
|----------|---------------|-------------|
| T | Black | +\$0 |
| D | Natural Maple | +\$0 |

FRAME

| CODE | DESCRIPTION | PRICE |
|------------------|----------------------------|--------------|
| P1 PAINT: | | +\$0 |
| BLCK | Textured Black Mica | |
| P7J | Textured Brownstone | |
| P7A | Textured Charcoal | |
| PK7 | Textured Designer White | |
| P7L | Textured Loft | |
| P7M | Textured Muslin | |
| PLAT | Textured Platinum Metallic | |
| P8V | Textured Titanium | |
| P2 PAINT: | | +\$0 |
| PR8 | Textured Silver | |
| P3 PAINT: | | +\$30 |
| P8S | Atom | |
| PJF | Bullseye | |
| P8P | Ember | |
| P8N | Ion | |
| P8J | Iris | |
| P8F | Krypton | |
| P8M | Regatta | |

| PLASTIC SHELL COLOR CODES (no upcharge): | | Tangelo - RG | Cherry - CR | Lime - LM | Calypso - CP | Surf - BU |
|--|--|---------------------|----------------------|-------------------|----------------------|--------------------|
| | | Regatta - RE | Mulberry - MB | Loft - LO | Platinum - PT | Shadow - SD |
| | | Lava - LA | Onyx - ON | White - WT | | |

SEATING

MOTIVATE®

Flex-Back Chair with Tablet Arm Fabric Options

HON BRANDED FABRICS

GRADE 1

Apex
Attire
Centurion
Compass
Contourett
Dapper
Ensemble
Hamilton
Inertia
Optic
Pebble

GRADE 2

Appoint Seating
Blume
Clyde
Dotty
Rush
Seed
Spin Seating
Whisper Vinyl

GRADE 3

In Season
Moxie
Parker
Purl
Quill

For a complete list of fabrics, including partnership fabrics, go to hon.com/fabricsandfinishes.

Reference Fabric Color Combinations on pages 18-22 for color codes and legend on page 19 for lead times.



MOTIVATE® Flex-Back Chair with Tablet Arm

HMNT1

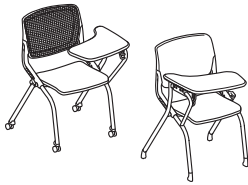

CHAIR

Flex-back with Tablet Arm

DIMENSIONS

| | | | |
|--------------|--------------------------------|---------------------------|--------------------------------|
| Depth: | 30 ³ / ₈ | Seat to Floor Height: | 18 ¹ / ₄ |
| Width: | 23 ¹ / ₂ | Tablet Height from Floor: | 29 ¹ / ₂ |
| Height: | 34 | Ship Weight: | 41 |
| Seat Depth: | 17 ¹ / ₄ | Cube: | 18.4 |
| Seat Width: | 17 | Weight Rating: | 300 lbs. |
| Back Width: | 19 ¹ / ₂ | | |
| Back Height: | 19 | | |

LIST PRICE

\$804

NOTES: Tablet can be specified on right or left side.

❗ Model HMNT1 is not available with an upholstered back.

❗ When selecting the mesh back option, seat shell will be in the specified shell color chosen but the frame around the mesh will always be black.

HMNT2

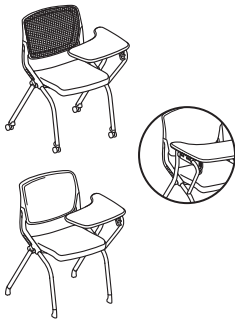

CHAIR

Flex-back with Tablet Arm
Upholstered Seat

DIMENSIONS

| | | | |
|--------------|--------------------------------|---------------------------|--------------------------------|
| Depth: | 30 ³ / ₈ | Seat to Floor Height: | 19 ¹ / ₄ |
| Width: | 23 ¹ / ₂ | Tablet Height from Floor: | 29 ¹ / ₂ |
| Height: | 34 | Ship Weight: | 42 |
| Seat Depth: | 17 ⁵ / ₈ | Cube: | 18.4 |
| Seat Width: | 17 ⁵ / ₈ | Weight Rating: | 300 lbs. |
| Back Width: | 19 ¹ / ₂ | | |
| Back Height: | 18 ⁵ / ₈ | | |

FABRIC PRICE CODES

| | | | |
|----------|---------------|-----------|---------------|
| 1 | \$886 | 8 | \$1024 |
| 2 | \$910 | 9 | \$1042 |
| 3 | \$934 | 10 | \$1060 |
| 4 | \$952 | 11 | \$1078 |
| 5 | \$970 | 12 | \$1096 |
| 6 | \$988 | L | — |
| 7 | \$1006 | | |

NOTES: Tablet can be specified on right or left side.

❗ When selecting the mesh back option, seat shell will be in the specified shell color chosen but the frame around the mesh will always be black.

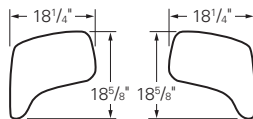

HON Recommendation: HMNT1.E.IM.ON.RT.D.PLAT - List Price \$884

HOW TO SPECIFY

| Select Model Number | Select Caster/Glide | Select Back Type | Select Shell Color | Select Fabric | Select Tablet Side | Select Tablet Color | Select Frame |
|---|--|--|---|---|---|---------------------|--------------|
| E Standard Nylon Guide H Hard Caster S All-Surface Caster (+ \$30) | PS Plastic Shell PB Upholstered (+ \$70) <i>PB option not available on HMNT1</i> 4-Way Stretch options (+ \$80) IM Black IF Fog IC Charcoal | RG Tangelo CR Cherry LM Lime CP Calypso BU Surf RE Regatta MB Mulberry LO Loft PT Platinum SD Shadow LA Lava ON Onyx WT White | See page 398 <i>Specify for model HMNT2 only</i> | RT Right Side LT Left Side | T Black D Natural Maple | See page 397 | |
| HMNT1 | E | IM | ON | | RT | D | PLAT |
| HMNT2 | E | PB | ON | CU10 | RT | D | PLAT |



HVL282



MID-BACK TASK CHAIR

Upholstered
Swivel-tilt
Height and Width Adjustable
Arms
Height-adjustable Back
Functions: **A, B, E, F, K, L, S**
(Function Key on pages 212-213)

DIMENSIONS

| | | | |
|--------------|-----|-----------------------|----------|
| Depth: | 25¼ | Arm Width: | 18½ |
| Width: | 26½ | Seat to Floor Height: | 18¾-22¾ |
| Height: | 43¾ | Ship Weight: | 47.0 |
| Seat Depth: | 16¾ | Cube: | 6.0 |
| Seat Width: | 19⅞ | Weight Rating: | 250 lbs. |
| Back Width: | 19⅞ | | |
| Back Height: | 20½ | | |

LIST PRICE

| | |
|---------------------|--------------|
| Swivel-tilt | \$449 |
| Asynchronous | \$504 |

NOTES: **HON 5-Year Limited Warranty.**

HON Recommendation: HVL282.Z1.VA10.T - List Price \$449

HVL283



HIGH-BACK TASK CHAIR

Upholstered
Asynchronous with Seat Slide
Height and Width Adjustable
Arms
Functions: **A, D, E, O, S**
(Function Key on pages 212-213)

DIMENSIONS

| | | | |
|--------------|-----|-----------------------|----------|
| Depth: | 25¼ | Arm Width: | 17¾ |
| Width: | 26½ | Seat to Floor Height: | 18¾-22¾ |
| Height: | 47¼ | Ship Weight: | 53.3 |
| Seat Depth: | 17⅞ | Cube: | 6.9 |
| Seat Width: | 19⅞ | Weight Rating: | 250 lbs. |
| Back Width: | 20⅞ | | |
| Back Height: | 23⅞ | | |

LIST PRICE

\$625

NOTES: **HON 5-Year Limited Warranty.**

HON Recommendation: HVL283.A2.VA10.T - List Price \$625

HOW TO SPECIFY

| Select Model Number | Select Control | Select Fabric | Select Frame |
|---------------------|--|--------------------------|----------------|
| HVL282 | Z1 Swivel Tilt <i>Available on HVL282 only</i> A2 Asynchronous with Seat Slide <i>Available on HVL282 and HVL283 only</i> | VA10 Black Fabric | T Black |

NEUTRALIZE™

Want to see more? Scan here
to check out hon.com.



Neutralize™ Mesh Task Chair with
Empower® Desks and Fuse™ Storage.

NEUTRALIZE™

Don't adjust your sitting preferences to fit your chair, make it fit your needs. Neutralize™ adjusts practically everywhere to perfectly fit your body and your work style. The breathable mesh back is made up of three articulating sections to fit anyone, including an adjustable headrest. The synchro-tilt control and fully adjustable arms support your body in any posture or position.



FEATURES

- Contemporary segmented mesh back enhancing support and increasing airflow.
- Height, width, depth, and pivot arms provide support right where you want it.
- Adjustable headrest delivers executive-level comfort.
- Mesh seat and seat slide conform to your body to reduce pressure points.
- HON 5-Year Limited Warranty.

NEUTRALIZE™ Mesh Chair

OPEN MARKET



Icon Legend on page 17

HVL791



MESH TASK CHAIR

Pneumatic
Swivel
Synchronized Tilt
Tilt Tension
Tilt Lock
Seat Glide Mechanism
Adjustable Headrest
All-Adjustable Arms

Functions: **A, D, E, J, K, L, B-A**
(Function Key on pages 212-213)

DIMENSIONS

| | | | |
|--------------|---------|-----------------------|----------|
| Depth: | 28¼ | Arm Width: | 20½ |
| Width: | 26¾ | Seat to Floor Height: | 18-21 |
| Height: | 52¼ | Usable Seat Depth: | 20 |
| Seat Depth: | 17¼-19¼ | Ship Weight: | 47.5 |
| Seat Width: | 19½ | Cube: | 7.8 |
| Back Width: | 20¼ | Weight Rating: | 250 lbs. |
| Back Height: | 32 | | |

LIST PRICE

\$906

NOTES: Comfortable and breathable mesh seat and back. Black frame with subtle chrome accents. Adjustable seat glide mechanism. Height, width, depth and pivot adjustable arms. Adjustable headrest. **HON 5-Year Limited Warranty.**

HON Recommendation: HVL791.BM.SB - List Price \$906

SEATING

HOW TO SPECIFY

Select
Model Number

H V L 7 9 1 .

Select
Fabric

BM Black Mesh

B M .

Select
Base

SB Standard Base

S B



Nucleus Work Chairs shown with Preside® Conference Table.

NUCLEUS®

Enjoy seating that delivers comfort from the inside out. Nucleus task and guest chairs adapt to everyone's unique body types to create a custom fit and targeted support. The back flexes with the spine. The seat cradles you like a hammock. The sophisticated aesthetic makes a stylish statement. Nucleus is the powerhouse seating family that brings cool and comfortable together.



GUEST CHAIR FEATURES

- Stacking chairs stack up to four high on the floor.
- HN6 guest chair available with glides, hard or all-surface casters.
- Available in hundreds of quality HON fabrics.
- Warranted for users up to 300 lbs.

TASK CHAIR FEATURES

- Advanced suspension material in the seat combines with molded foam to create unparalleled support.
- Choose between the 4-Way Stretch mesh back or an upholstered suspension back.
- 4-Way Stretch mesh back is available in seven colors.
- Choose between armless, fixed arms or height- and width-adjustable arms.
- Responsive synchro-tilt control provides a smooth, natural recline.
- Available in Black or Polished Aluminum base.
- Tilt tension controls the rate and ease of recline.
- Tilt lock allows the user to lock the back in multiple recline positions.
- Available in hundreds of quality HON fabrics.
- Warranted for users up to 300 lbs.

NUCLEUS® Task Chair Options

MODEL OPTIONS

HN1



Task Chair (4-Way Stretch Back)

Pneumatic, Swivel, Seat Glide, Synchro-tilt, Tilt Tension, Tilt Lock, Armless

HN1U*



Task Chair (Upholstered Back)

Pneumatic, Swivel, Seat Glide, Synchro-tilt, Tilt Tension, Tilt Lock, Armless

ARM STYLE

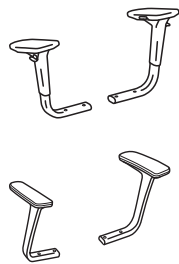

| CODE | DESCRIPTION | PRICE |
|----------|----------------------------------|---------------|
| N | Armless | +\$0 |
| A | Height and Width Adjustable Arms | +\$85 |
| P | Fixed Arms - Polished | +\$175 |

BASE

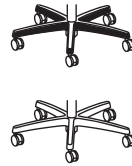

| CODE | DESCRIPTION | PRICE |
|-----------|-------------------|---------------|
| SB | Standard Base | +\$0 |
| PA | Polished Aluminum | +\$110 |

FRAME

| CODE | DESCRIPTION | PRICE |
|----------|-------------|-------------|
| T | Black | +\$0 |

CASTERS



| CODE | DESCRIPTION | PRICE |
|----------|--------------------------|--------------|
| H | Black Hard Caster | +\$0 |
| S | Black All-Surface Caster | +\$40 |

BACK STYLE

| CODE | DESCRIPTION | PRICE |
|---|-------------|-------------|
| <i>4-Way Stretch mesh back options:</i> | | |
| IM | Black | +\$0 |
| IB | Breeze | +\$0 |
| IK | Brownstone | +\$0 |
| IC | Charcoal | +\$0 |
| IF | Fog | +\$0 |
| IR | Regatta | +\$0 |
| IT | Titanium | +\$0 |

* De-emphasized

NUCLEUS® Multi-Purpose and Café Chair Options

MODEL OPTIONS

HN6



**Multi-Purpose Stack Chair
(4-Way Stretch Back)**

Four Legs

HN7*

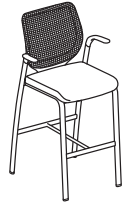

**Café-Height Stool (4-Way Stretch
Back)**

Four Legs

ARM STYLE



| CODE | DESCRIPTION | PRICE |
|----------|-------------|--------------|
| N | Armless | +\$0 |
| F | Fixed Arms | +\$30 |

CASTERS/ GLIDE



| CODE | DESCRIPTION | PRICE |
|----------|---|-------------|
| H | Black Hard Caster <i>*Not available on HN7</i> | +\$0 |



| | | |
|----------|--|--------------|
| S | Black All-Surface Caster <i>*Not available on HN7</i> | +\$20 |
|----------|--|--------------|



| | | |
|----------|-------|-------------|
| E | Glide | +\$0 |
|----------|-------|-------------|

BACK STYLE

| CODE | DESCRIPTION | PRICE |
|---|-------------|-------------|
| <i>4-Way Stretch mesh back options:</i> | | |
| IM | Black | +\$0 |
| IB | Breeze | +\$0 |
| IK | Brownstone | +\$0 |
| IC | Charcoal | +\$0 |
| IF | Fog | +\$0 |
| IR | Regatta | +\$0 |
| IT | Titanium | +\$0 |

FRAME

| CODE | DESCRIPTION | PRICE |
|-----------|-------------------|-------------|
| T | Black | +\$0 |
| T1 | Platinum Metallic | +\$0 |

* De-emphasized

SEATING

NUCLEUS[®]

Fabric Options

HON BRANDED FABRICS

GRADE 1

Apex
Attire
Centurion
Compass
Contourett
Dapper
Ensemble
Hamilton
Inertia
Optic
Pebble

GRADE 2

Appoint Seating
Blume
Clyde
Dotty
Rush
Seed
Spin Seating
Whisper Vinyl

GRADE 3

In Season
Moxie
Parker
Purl
Quill

For a complete list of fabrics, including partnership fabrics, go to hon.com/fabricsandfinishes.

Reference Fabric Color Combinations on pages 18-22 for color codes and legend on page 19 for lead times. For additional HON to Supply COM fabric grade pricing, go to honready.hon.com and click on the HON to Supply COM link.



Icon Legend on page 17

HN1



TASK CHAIR

4-Way Stretch Back

- Pneumatic
- Swivel
- Seat Glide
- Synchro-tilt
- Tilt Tension
- Tilt Lock
- Armless

Functions:

A, D, E, A-C, A-D, J, L

(Function Key on pages 212-213)

HON Recommendation: HN1.A.H.IM.CU__SB.T - List Price \$1017

DIMENSIONS

| | | | |
|--------------|-----|-----------------------|----------|
| Depth: | 25¾ | Arm Width: | 17-20 |
| Width: | 28¾ | Seat to Floor Height: | 17-22 |
| Height: | 45¼ | Usable Seat Depth: | 16½-19½ |
| Seat Depth: | 20 | Ship Weight: | 52 |
| Seat Width: | 20 | Cube: | 11.3 |
| Back Width: | 19¼ | COM: | 1.0 |
| Back Height: | 25¼ | Weight Rating: | 300 lbs. |

FABRIC PRICE CODES

| | | | |
|----------|---------------|-----------|---------------|
| 1 | \$932 | 8 | \$1070 |
| 2 | \$956 | 9 | \$1088 |
| 3 | \$980 | 10 | \$1106 |
| 4 | \$998 | 11 | \$1124 |
| 5 | \$1016 | 12 | \$1142 |
| 6 | \$1034 | L | — |
| 7 | \$1052 | | |

HOW TO SPECIFY

| Select Model Number | Select Arm Type | Select Caster/Glide | Select Back Type | Select Fabric | Select Base | Select Frame |
|---------------------|--|--|--|---------------|--|--------------------------------|
| | N Armless A Height and Width Adjustable Arms (+ \$85) P Fixed Arms - Polished (+ \$175) | H Black Hard Caster S Black All-Surface Caster (+ \$40) | 4-Way Stretch options IM Black IB Breeze IK Brownstone IC Charcoal IF Fog IR Regatta IT Titanium | See page 406 | SB Standard Base PA Polished Aluminum (+ \$110) | See page 404 T Black |
| HN1 | A | H | IM | CU10 | SB | T |

HN1U*



TASK CHAIR

Upholstered Back

- Pneumatic
- Swivel
- Seat Glide
- Synchro-tilt
- Tilt Tension
- Tilt Lock
- Armless

Functions:

A, D, E, A-C, A-D, J, L

(Function Key on pages 212-213)

HON Recommendation: HN1U.A.H.CU__SB.T - List Price \$1017

DIMENSIONS

| | | | |
|--------------|-----|-----------------------|----------|
| Depth: | 26 | Arm Width: | 19⅞ |
| Width: | 28¾ | Seat to Floor Height: | 17-22 |
| Height: | 44¼ | Usable Seat Depth: | 16-19 |
| Seat Depth: | 20 | Ship Weight: | 49 |
| Seat Width: | 20 | Cube: | 12.6 |
| Back Width: | 18¼ | COM: | 2.0 |
| Back Height: | 25½ | Weight Rating: | 300 lbs. |

FABRIC PRICE CODES

| | | | |
|----------|---------------|-----------|---------------|
| 1 | \$932 | 8 | \$1208 |
| 2 | \$980 | 9 | \$1244 |
| 3 | \$1028 | 10 | \$1280 |
| 4 | \$1064 | 11 | \$1316 |
| 5 | \$1100 | 12 | \$1352 |
| 6 | \$1136 | L | — |
| 7 | \$1172 | | |

* De-emphasized

HOW TO SPECIFY

| Select Model Number | Select Arm Type | Select Caster/Glide | Select Fabric | Select Base | Select Frame |
|---------------------|--|--|---------------|--|--------------------------------|
| | N Armless A Height and Width Adjustable Arms (+ \$85) P Fixed Arms - Polished (+ \$175) | H Black Hard Caster S Black All-Surface Caster (+ \$40) | See page 406 | SB Standard Base PA Polished Aluminum (+ \$110) | See page 404 T Black |
| HN1U | A | H | CU10 | SB | T |

NUCLEUS®



Icon Legend on page 17

HN6

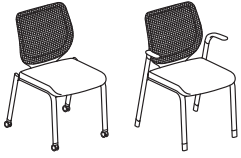

MULTI-PURPOSE STACK CHAIR

4-Way Stretch Back
Four Legs

DIMENSIONS

| | | | |
|--------------|-----|-----------------------|----------|
| Depth: | 26¼ | Arm Width: | 21½ |
| Width: | 27 | Seat to Floor Height: | 18½ |
| Height: | 37½ | Usable Seat Depth: | 18½ |
| Seat Depth: | 19 | Ship Weight: | 31 |
| Seat Width: | 19 | Cube: | 15.2 |
| Back Width: | 18 | COM: | 1.0 |
| Back Height: | 18½ | Weight Rating: | 300 lbs. |

FABRIC PRICE CODES

| | | | |
|---|-------|----|-------|
| 1 | \$571 | 8 | \$709 |
| 2 | \$595 | 9 | \$727 |
| 3 | \$619 | 10 | \$745 |
| 4 | \$637 | 11 | \$763 |
| 5 | \$655 | 12 | \$781 |
| 6 | \$673 | L | — |
| 7 | \$691 | | |

HN7 *

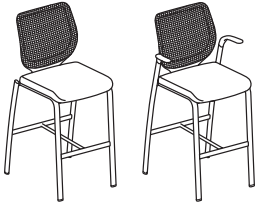

CAFÉ-HEIGHT STOOL

4-Way Stretch Back
Four Legs

DIMENSIONS

| | | | |
|--------------|-----|-----------------------|----------|
| Depth: | 24½ | Arm Width: | 21½ |
| Width: | 25 | Seat to Floor Height: | 30 |
| Height: | 46½ | Usable Seat Depth: | 18½ |
| Seat Depth: | 19 | Ship Weight: | 40 |
| Seat Width: | 19 | Cube: | 21.4 |
| Back Width: | 18 | COM: | 1.0 |
| Back Height: | 18½ | Weight Rating: | 300 lbs. |

FABRIC PRICE CODES

| | | | |
|---|-------|----|-------|
| 1 | \$622 | 8 | \$760 |
| 2 | \$646 | 9 | \$778 |
| 3 | \$670 | 10 | \$796 |
| 4 | \$688 | 11 | \$814 |
| 5 | \$706 | 12 | \$832 |
| 6 | \$724 | L | — |
| 7 | \$742 | | |

HON Recommendation: HN6.F.H.IM.CU__T - List Price \$601

* De-emphasized

HOW TO SPECIFY

| Select Model Number | Select Arm Type | Select Caster/Glide | Select Back Type | Select Fabric | Select Frame |
|---------------------|--|--|--|---------------|---|
| | F Fixed Arms (+ \$30) N Armless | E Glide H Black Hard Caster S Black All-Surface Caster (+ \$30) <i>Casters available on HN6 only</i> | 4-Way Stretch options IM Black IB Breeze IK Brownstone IC Charcoal IF Fog IR Regatta IT Titanium | See page 406 | T Black T1 Platinum Metallic |
| HN6 | F | H | IM | CU10 | T |

HNATA *



ADJUSTABLE ARM PACK

Height and Width
Functions: **S**
(Function Key on pages 212-213)

DIMENSIONS

| | |
|-------------------|--------------|
| Arm Width: | 17-20 |
| Height from Seat: | 6⅞-10⅞ |
| Ship Weight: | 7.5 S |
| Cube: | 1.0 |

LIST PRICE

\$133

HNFPA *



POLISHED ALUMINUM ARM PACK

Fixed Height

DIMENSIONS

| | |
|-------------------|--------------|
| Arm Width: | 19⅞ |
| Height from Seat: | 7¼ |
| Ship Weight: | 7.5 S |
| Cube: | 1.0 |

LIST PRICE

\$208

OPEN MARKET

* De-emphasized

HOW TO SPECIFY

| Select Model Number |
|---------------------|
| HNATA |

HIGH-DENSITY OLSON STACKER® 4040 SERIES

Want to see more?
Scan here to check
out hon.com.



Olson Stacker.

HIGH-DENSITY OLSON STACKER® 4040 SERIES

Adaptable spaces such as multi-purpose and training areas demand a chair equally flexible. Olson stacking chairs fit that bill with a lightweight frame that is easy to move throughout a space. Chairs stack up to 12 high on the floor or up to 40 high on their specially designed cart to maximize floor space when not in use. A convenient cutout in the back makes it easy to pick up and move, while the molded seat shells deliver surprising comfort. Olson stacking chairs ship in sets of four to accommodate large groups. With Olson, the benefits really stack up.



FEATURES

- Chairs ship four per carton.
- Contoured seat and back shell provide targeted support.
- Integrated lumbar support delivers long-lasting comfort.
- Integrated handle makes chair easy to carry.
- Optional ganging brackets connect chairs to form neat rows.
- Stacks up to 12 high on floor.
- Stacks up to 40 high on cart.
- Shell colors are CA Technical Bulletin 133 compliant.
- Warranted for users up to 300 lbs.

HIGH-DENSITY OLSON STACKER® 4040 Series

GSA SIN 33721



Icon Legend on page 17

H4041



POLYMER SEAT AND BACK DIMENSIONS

7/16" Steel Rod Frame
Chrome Legs

| | | | |
|--------------|--------------------------------|-----------------------|--------------------------------|
| Depth: | 21 ⁵ / ₈ | Seat to Floor Height: | 17 ³ / ₄ |
| Width: | 19 ¹ / ₈ | Usable Seat Depth: | 17 |
| Height: | 30 ⁵ / ₈ | Ship Weight: | 57 |
| Seat Depth: | 18 ¹ / ₄ | Cube: | 10.6 |
| Seat Width: | 17 ³ / ₄ | Weight Rating: | 300 lbs. |
| Back Width: | 17 ¹ / ₂ | | |
| Back Height: | 16 ¹ / ₄ | | |

LIST PRICE PER CARTON

\$770
(reference single unit @ \$192.50)

⊕ 4040 Series is ordered and shipped four (4) chairs per carton. Pricing shown is per carton. Each set of four (one carton), must have the same shell color. Ordering 2 of Model H4041 will result in 2 cartons being shipped, giving you 8 chairs.

⚠ Shipped fully assembled — 4 chairs per carton. All High-Density Olson Stacker® shell colors are CA Technical Bulletin 133 compliant (no upcharge).

H4043

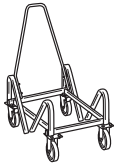

CART FOR STACKING CHAIRS

DIMENSIONS

| | | | |
|---------|--------------------------------|--------------|-----|
| Depth: | 35 ¹ / ₂ | Ship Weight: | 34 |
| Width: | 21 ³ / ₈ | Cube: | 7.8 |
| Height: | 37 | | |

LIST PRICE

\$537

NOTES: Holds 40 stack chairs (6'-8"), some assembly required. (Chairs stack 12 high without cart.)

⚠ Specify Black paint (T) ONLY.

H4048

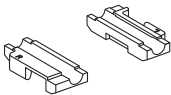

GANGING CHAIR GLIDES

Box of 48
For use on models H4041, HG51
and HG52

DIMENSIONS

| | |
|--------------|------|
| Ship Weight: | 1 |
| Cube: | 0.04 |

LIST PRICE

\$137

H4049

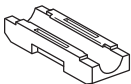

NON-GANGING CHAIR GLIDES

Box of 48
For use on models H4041,
HFLEX01, HG51 and HG52

DIMENSIONS

| | |
|--------------|------|
| Ship Weight: | 1 |
| Cube: | 0.04 |

LIST PRICE

\$109

HOW TO SPECIFY

| | | | | | | | | | | | | | | | | |
|--|--|------------|---------|-----------|-------------|---------|-----------|------------|---------|---------|---------|------------|----------|-------------|--|---|
| <p>Select Model Number</p> <p>H 4 0 4 1 .</p> | <p>Select Shell Color</p> <table border="0"> <tr> <td>RG Tangelo</td> <td>LO Loft</td> </tr> <tr> <td>CR Cherry</td> <td>PT Platinum</td> </tr> <tr> <td>LM Lime</td> <td>SD Shadow</td> </tr> <tr> <td>CP Calypso</td> <td>LA Lava</td> </tr> <tr> <td>BU Surf</td> <td>ON Onyx</td> </tr> <tr> <td>RE Regatta</td> <td>WT White</td> </tr> <tr> <td>MB Mulberry</td> <td></td> </tr> </table> <p>ON .</p> | RG Tangelo | LO Loft | CR Cherry | PT Platinum | LM Lime | SD Shadow | CP Calypso | LA Lava | BU Surf | ON Onyx | RE Regatta | WT White | MB Mulberry | | <p>Select Frame</p> <p>Y Chrome</p> <p>Y</p> |
| RG Tangelo | LO Loft | | | | | | | | | | | | | | | |
| CR Cherry | PT Platinum | | | | | | | | | | | | | | | |
| LM Lime | SD Shadow | | | | | | | | | | | | | | | |
| CP Calypso | LA Lava | | | | | | | | | | | | | | | |
| BU Surf | ON Onyx | | | | | | | | | | | | | | | |
| RE Regatta | WT White | | | | | | | | | | | | | | | |
| MB Mulberry | | | | | | | | | | | | | | | | |



Pagoda® Guest Chairs with
Preside® Tables Café Stools.

PAGODA®

Roll out the welcome mat with Pagoda guest chairs. Reception areas. Private offices. Anywhere in between. Pagoda is a coordinated, versatile collection of stacking chairs and stools that easily match any environment and offer comfort for any type of activity. Standard-height chairs stack up to five high to clear valuable floor space whenever needed. Counter-height stools are great for cafés or common areas. Wherever comfort and style are equally important, Pagoda will create the look and feel you need.



FEATURES

- Guest chairs stack up to five high on the floor.
- Fully-upholstered outer back.
- Molded seat underpan protects seat fabric and creates a finished appearance when stacked.
- Optional fixed arms are gently sloped for maximum comfort.
- Tube rolled steel frame adds durability.
- Create a contemporary mixed material aesthetic.
- Optional wood veneer back is available in five attractive finishes.
- Available in hundreds of quality HON fabrics.
- Warranted for users up to 250 lbs.

PAGODA[®]

Options

MODEL OPTIONS

H4071



Stacking Arm Guest Chairs
Set of Two

H4073



Stacking Armless Guest Chairs
Set of Two

H4075

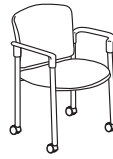

Stacking Arm Guest Chairs
Set of Two

H4077



Mobile Stacking Armless Guest Chairs
Set of Two

H4091



Stacking Arm Guest Chairs (Wood Back)
Set of Two

H4093



Stacking Armless Guest Chairs (Wood Back)
Set of Two

H4095



Stacking Arm Guest Chairs (Wood Back)
Set of Two

H4097



Mobile Stacking Armless Guest Chairs (Wood Back)
Set of Two

H4099

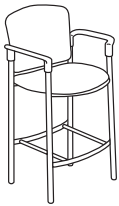

Café-Height Stool (Wood Back)
Footrest, Arms

H4079



Café-Height Stool (Upholstered Back)
Footrest, Arms

| CASTERS | | | | FINISH | | | |
|---|----------|-------------|--------------|--------|----------|----------------|-------------|
| | CODE | DESCRIPTION | PRICE | | CODE | DESCRIPTION | PRICE |
|  | H | Hard Caster | +\$0 | | C | Harvest | +\$0 |
|  | S | Soft Caster | +\$20 | | D | Natural Maple | +\$0 |
| | | | | | F | Shaker Cherry | +\$0 |
| | | | | | H | Bourbon Cherry | +\$0 |
| | | | | | N | Mahogany | +\$0 |

**Specify for models H4075 and H4077 only*

**Specify for models H4091, H4093, H4095, H4097 and H4099 only*

| FRAME | | | |
|-------|-----------|-------------------|-------------|
| | CODE | DESCRIPTION | PRICE |
| | T | Black | +\$0 |
| | T1 | Platinum Metallic | +\$0 |

HON BRANDED FABRICS

GRADE 1

Apex
Attire
Centurion
Compass
Contourett
Dapper
Ensemble
Hamilton
Inertia
Optic
Pebble

GRADE 2

Appoint Seating
Blume
Clyde
Dotty
Rush
Seed
Spin Seating
Whisper Vinyl

GRADE 3

In Season
Moxie
Parker
Purl
Quill

For a complete list of fabrics, including partnership fabrics, go to hon.com/fabricsandfinishes.

**Pagoda® wood back models available in Harvest (C), Natural Maple (D), Shaker Cherry (F), Bourbon Cherry (H) and Mahogany (N) only.

Reference Fabric Color Combinations on pages 18-22 for color codes and legend on page 19 for lead times. For additional HON to Supply COM fabric grade pricing, go to honready.hon.com and click on the HON to Supply COM link.

PAGODA® 4070 Series

GSA SIN 33721



Icon Legend on page 17

H4071



STACKING ARM GUEST CHAIRS

Set of Two

DIMENSIONS

| | | | |
|--------------|-----|-----------------------|----------|
| Depth: | 22½ | Arm Width: | 23¾ |
| Width: | 27¼ | Seat to Floor Height: | 18 |
| Height: | 33 | Usable Seat Depth: | 16¾ |
| Seat Depth: | 19¾ | Ship Weight: | 56 |
| Seat Width: | 20¼ | Cube: | 19.6 |
| Back Width: | 21¼ | COM (per 2 pack): | 2.5 |
| Back Height: | 16¼ | Weight Rating: | 250 lbs. |

FABRIC PRICE CODES

| | Per Carton List Price | Single Unit List Price |
|----|--------------------------|---------------------------|
| 1 | \$1135 | \$567.50 |
| 2 | \$1183 | \$591.50 |
| 3 | \$1231 | \$615.50 |
| 4 | \$1267 | \$633.50 |
| 5 | \$1303 | \$651.50 |
| 6 | \$1339 | \$669.50 |
| 7 | \$1375 | \$687.50 |
| 8 | \$1411 | \$705.50 |
| 9 | \$1447 | \$723.50 |
| 10 | \$1483 | \$741.50 |
| 11 | \$1519 | \$759.50 |
| 12 | \$1555 | \$777.50 |
| L | — | — |

NOTES: Use Model H4069 Ganging Connectors on page 418. Ships two to a container. See shipping notes on page 415.

H4073



STACKING ARMLESS GUEST CHAIRS

Set of Two

DIMENSIONS

| | | | |
|--------------|-----|-----------------------|----------|
| Depth: | 22½ | Seat to Floor Height: | 18 |
| Width: | 21¼ | Usable Seat Depth: | 16¾ |
| Height: | 33 | Ship Weight: | 52 |
| Seat Depth: | 19¾ | Cube: | 18.9 |
| Seat Width: | 20¼ | COM (per 2 pack): | 2.5 |
| Back Width: | 21¼ | Weight Rating: | 250 lbs. |
| Back Height: | 16¼ | | |

FABRIC PRICE CODES

| | Per Carton List Price | Single Unit List Price |
|----|--------------------------|---------------------------|
| 1 | \$1059 | \$529.50 |
| 2 | \$1107 | \$553.50 |
| 3 | \$1155 | \$577.50 |
| 4 | \$1191 | \$595.50 |
| 5 | \$1227 | \$613.50 |
| 6 | \$1263 | \$631.50 |
| 7 | \$1299 | \$649.50 |
| 8 | \$1335 | \$667.50 |
| 9 | \$1371 | \$685.50 |
| 10 | \$1407 | \$703.50 |
| 11 | \$1443 | \$721.50 |
| 12 | \$1479 | \$739.50 |
| L | — | — |

NOTES: Use Model H4069 Ganging Connectors on page 418. Ships two to a container. See shipping notes on page 415.

HOW TO SPECIFY

Select
Model Number

H 4 0 7 1 .

Select
Fabric

See page 413

C U 1 0 .

Select
Frame

T Black
T1 Platinum Metallic

T



PAGODA® 4070 Series

H4075



STACKING ARM GUEST CHAIRS

Set of Two

DIMENSIONS

| | | | |
|--------------|-----|-----------------------|----------|
| Depth: | 22½ | Arm Width: | 23¾ |
| Width: | 27¼ | Seat to Floor Height: | 18 |
| Height: | 33 | Usable Seat Depth: | 16¾ |
| Seat Depth: | 19¾ | Ship Weight: | 56 |
| Seat Width: | 20¼ | Cube: | 19.6 |
| Back Width: | 21¼ | COM (per 2 pack): | 2.5 |
| Back Height: | 16¼ | Weight Rating: | 250 lbs. |

FABRIC PRICE CODES

| | Per Carton List Price | Single Unit List Price |
|----|--------------------------|---------------------------|
| 1 | \$1271 | \$635.50 |
| 2 | \$1319 | \$659.50 |
| 3 | \$1367 | \$683.50 |
| 4 | \$1403 | \$701.50 |
| 5 | \$1439 | \$719.50 |
| 6 | \$1475 | \$737.50 |
| 7 | \$1511 | \$755.50 |
| 8 | \$1547 | \$773.50 |
| 9 | \$1583 | \$791.50 |
| 10 | \$1619 | \$809.50 |
| 11 | \$1655 | \$827.50 |
| 12 | \$1691 | \$845.50 |
| L | — | — |

H4077



MOBILE STACKING ARMLESS GUEST CHAIRS

Set of Two

DIMENSIONS

| | | | |
|--------------|-----|-----------------------|----------|
| Depth: | 22½ | Seat to Floor Height: | 18 |
| Width: | 21¼ | Usable Seat Depth: | 16¾ |
| Height: | 33 | Ship Weight: | 56 |
| Seat Depth: | 19¾ | Cube: | 19.5 |
| Seat Width: | 20¼ | COM (per 2 pack): | 2.5 |
| Back Width: | 21¼ | Weight Rating: | 250 lbs. |
| Back Height: | 16¼ | | |

FABRIC PRICE CODES

| | Per Carton List Price | Single Unit List Price |
|----|--------------------------|---------------------------|
| 1 | \$1196 | \$598.00 |
| 2 | \$1244 | \$622.00 |
| 3 | \$1292 | \$646.00 |
| 4 | \$1328 | \$664.00 |
| 5 | \$1364 | \$682.00 |
| 6 | \$1400 | \$700.00 |
| 7 | \$1436 | \$718.00 |
| 8 | \$1472 | \$736.00 |
| 9 | \$1508 | \$754.00 |
| 10 | \$1544 | \$772.00 |
| 11 | \$1580 | \$790.00 |
| 12 | \$1616 | \$808.00 |
| L | — | — |

ⓘ 4070 Series is ordered and shipped two (2) chairs per carton. Pricing shown is per carton. Each set of two (one carton), must have the same fabric/frame color. (COM yardage shown is for two chairs.) Ordering 2 of any model will result in 2 cartons being shipped, giving you 4 chairs.

HOW TO SPECIFY

| | | | |
|--|---|--|---|
| <p>Select Model Number</p> <p>H 4 0 7 5 .</p> | <p>Select Caster</p> <p>H Hard Caster S Soft Caster (+ \$20) <i>Specify for models H4075 and H4077 only</i></p> <p>H .</p> | <p>Select Fabric</p> <p>See page 413</p> <p>C U 1 0 .</p> | <p>Select Frame</p> <p>T Black T1 Platinum Metallic</p> <p>T</p> |
|--|---|--|---|

PAGODA® 4090 Series

GSA SIN 33721



Icon Legend on page 17

H4091



STACKING ARM GUEST CHAIRS

Wood Back
Set of Two

DIMENSIONS

| | | | |
|--------------|-----|-----------------------|----------|
| Depth: | 22½ | Arm Width: | 23¾ |
| Width: | 27¼ | Seat to Floor Height: | 18 |
| Height: | 32½ | Usable Seat Depth: | 16¾ |
| Seat Depth: | 19¾ | Ship Weight: | 51 |
| Seat Width: | 20¼ | Cube: | 19.6 |
| Back Width: | 21¼ | COM (per 2 pack): | 1.0 |
| Back Height: | 16¼ | Weight Rating: | 250 lbs. |

FABRIC PRICE CODES

| | Per Carton List Price | Single Unit List Price |
|----|--------------------------|---------------------------|
| 1 | \$1318 | \$659.00 |
| 2 | \$1342 | \$671.00 |
| 3 | \$1366 | \$683.00 |
| 4 | \$1384 | \$692.00 |
| 5 | \$1402 | \$701.00 |
| 6 | \$1420 | \$710.00 |
| 7 | \$1438 | \$719.00 |
| 8 | \$1456 | \$728.00 |
| 9 | \$1474 | \$737.00 |
| 10 | \$1492 | \$746.00 |
| 11 | \$1510 | \$755.00 |
| 12 | \$1528 | \$764.00 |
| L | — | — |

NOTES: Use Model H4069 Ganging Connectors on page 418.

! Ships two per carton. See note on page 417 for ordering.

H4093



STACKING ARMLESS GUEST CHAIRS

Wood Back
Set of Two

DIMENSIONS

| | | | |
|--------------|-----|-----------------------|----------|
| Depth: | 22½ | Seat to Floor Height: | 18 |
| Width: | 21¼ | Usable Seat Depth: | 16¾ |
| Height: | 32½ | Ship Weight: | 49 |
| Seat Depth: | 19¾ | Cube: | 18.9 |
| Seat Width: | 20¼ | COM (per 2 pack): | 1.0 |
| Back Width: | 20½ | Weight Rating: | 250 lbs. |
| Back Height: | 16¼ | | |

FABRIC PRICE CODES

| | Per Carton List Price | Single Unit List Price |
|----|--------------------------|---------------------------|
| 1 | \$1242 | \$621.00 |
| 2 | \$1266 | \$633.00 |
| 3 | \$1290 | \$645.00 |
| 4 | \$1308 | \$654.00 |
| 5 | \$1326 | \$663.00 |
| 6 | \$1344 | \$672.00 |
| 7 | \$1362 | \$681.00 |
| 8 | \$1380 | \$690.00 |
| 9 | \$1398 | \$699.00 |
| 10 | \$1416 | \$708.00 |
| 11 | \$1434 | \$717.00 |
| 12 | \$1452 | \$726.00 |
| L | — | — |

NOTES: Use Model H4069 Ganging Connectors on page 418.

! Ships two per carton. See note on page 417 for ordering.

! Pagoda® wood back models available in Harvest (C), Natural Maple (D), Shaker Cherry (F), Bourbon Cherry (H) and Mahogany (N) only.

HOW TO SPECIFY

| | | | |
|--|--|--|---|
| <p>Select Model Number</p> <p>H 4 0 9 1 .</p> | <p>Select Finish Color</p> <p>See page 413</p> <p>H .</p> | <p>Select Fabric</p> <p>See page 413</p> <p>C U 1 0 .</p> | <p>Select Frame</p> <p>T Black T1 Platinum Metallic</p> <p>T</p> |
|--|--|--|---|



PAGODA® 4090 Series

H4095



STACKING ARM GUEST CHAIRS

Wood Back
Set of Two

DIMENSIONS

| | | | |
|--------------|-----|-----------------------|----------|
| Depth: | 22½ | Arm Width: | 23¾ |
| Width: | 27¼ | Seat to Floor Height: | 18 |
| Height: | 32½ | Usable Seat Depth: | 16¾ |
| Seat Depth: | 19¾ | Ship Weight: | 53 |
| Seat Width: | 20¼ | Cube: | 19.6 |
| Back Width: | 20½ | COM (per 2 pack): | 1.0 |
| Back Height: | 16¼ | Weight Rating: | 250 lbs. |

FABRIC PRICE CODES

| | Per Carton List Price | Single Unit List Price |
|----|--------------------------|---------------------------|
| 1 | \$1458 | \$729.00 |
| 2 | \$1482 | \$741.00 |
| 3 | \$1506 | \$753.00 |
| 4 | \$1524 | \$762.00 |
| 5 | \$1542 | \$771.00 |
| 6 | \$1560 | \$780.00 |
| 7 | \$1578 | \$789.00 |
| 8 | \$1596 | \$798.00 |
| 9 | \$1614 | \$807.00 |
| 10 | \$1632 | \$816.00 |
| 11 | \$1650 | \$825.00 |
| 12 | \$1668 | \$834.00 |
| L | — | — |

! Ships two per carton. See note below for ordering.

H4097



MOBILE STACKING ARMLESS GUEST CHAIRS

Wood Back
Set of Two

DIMENSIONS

| | | | |
|--------------|-----|-----------------------|----------|
| Depth: | 22½ | Seat to Floor Height: | 18 |
| Width: | 21¼ | Usable Seat Depth: | 16¾ |
| Height: | 32½ | Ship Weight: | 51 |
| Seat Depth: | 19¾ | Cube: | 19.6 |
| Seat Width: | 20¼ | COM (per 2 pack): | 1.0 |
| Back Width: | 20½ | Weight Rating: | 250 lbs. |
| Back Height: | 16¼ | | |

FABRIC PRICE CODES

| | Per Carton List Price | Single Unit List Price |
|----|--------------------------|---------------------------|
| 1 | \$1383 | \$691.50 |
| 2 | \$1407 | \$703.50 |
| 3 | \$1431 | \$715.50 |
| 4 | \$1449 | \$724.50 |
| 5 | \$1467 | \$733.50 |
| 6 | \$1485 | \$742.50 |
| 7 | \$1503 | \$751.50 |
| 8 | \$1521 | \$760.50 |
| 9 | \$1539 | \$769.50 |
| 10 | \$1557 | \$778.50 |
| 11 | \$1575 | \$787.50 |
| 12 | \$1593 | \$796.50 |
| L | — | — |

! Ships two per carton. See note below for ordering.

2 4090 Series is ordered and shipped two (2) chairs per carton. Pricing shown is per carton. Each set of two (one carton), must have the same fabric/frame color. (COM yardage shown is for two chairs.) Ordering 2 of any model will result in 2 cartons being shipped, giving you 4 chairs.

! Pagoda® wood back models available in Harvest (C), Natural Maple (D), Shaker Cherry (F), Bourbon Cherry (H) and Mahogany (N) only.

HOW TO SPECIFY

| | | | |
|--|--|--|---|
| <p>Select Model Number</p> <p>H 4 0 9 5 .</p> | <p>Select Finish Color</p> <p>See page 413</p> <p>H .</p> | <p>Select Fabric</p> <p>See page 413</p> <p>C U 1 0 .</p> | <p>Select Frame</p> <p>T Black TI Platinum Metallic</p> <p>T</p> |
|--|--|--|---|

PAGODA® 4070/4090 Series

GSA SIN 33721



Icon Legend on page 17

H4099

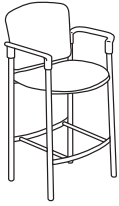

CAFÉ-HEIGHT STOOL

Wood Back
Footrest
Arms

DIMENSIONS

| | | | |
|--------------|-----|-----------------------|----------|
| Depth: | 22½ | Arm Width: | 23¾ |
| Width: | 27¼ | Seat to Floor Height: | 29⅝ |
| Height: | 44⅝ | Usable Seat Depth: | 16¾ |
| Seat Depth: | 19¾ | Ship Weight: | 34 |
| Seat Width: | 20¼ | Cube: | 19.3 |
| Back Width: | 20½ | COM: | 1.0 |
| Back Height: | 16¼ | Weight Rating: | 250 lbs. |

FABRIC PRICE CODES

Single Unit List Price

| | |
|----|-----------|
| 1 | \$851.00 |
| 2 | \$875.00 |
| 3 | \$899.00 |
| 4 | \$917.00 |
| 5 | \$935.00 |
| 6 | \$953.00 |
| 7 | \$971.00 |
| 8 | \$989.00 |
| 9 | \$1007.00 |
| 10 | \$1025.00 |
| 11 | \$1043.00 |
| 12 | \$1061.00 |
| L | — |

NOTES: Model H4099 is ordered and shipped one (1) per carton.

H4079



CAFÉ-HEIGHT STOOL

Upholstered Back
Footrest
Arms

DIMENSIONS

| | | | |
|--------------|-----|-----------------------|----------|
| Depth: | 22½ | Arm Width: | 23¾ |
| Width: | 27¼ | Seat to Floor Height: | 29⅝ |
| Height: | 44⅝ | Usable Seat Depth: | 16¾ |
| Seat Depth: | 19¾ | Ship Weight: | 39 |
| Seat Width: | 20¼ | Cube: | 19.3 |
| Back Width: | 21¼ | COM: | 1.0 |
| Back Height: | 16¼ | Weight Rating: | 250 lbs. |

FABRIC PRICE CODES

Single Unit List Price

| | |
|----|-----------|
| 1 | \$741.00 |
| 2 | \$789.00 |
| 3 | \$837.00 |
| 4 | \$873.00 |
| 5 | \$909.00 |
| 6 | \$945.00 |
| 7 | \$981.00 |
| 8 | \$1017.00 |
| 9 | \$1053.00 |
| 10 | \$1089.00 |
| 11 | \$1125.00 |
| 12 | \$1161.00 |
| L | — |

NOTES: Upholstered back. Model H4079 is ordered and shipped one (1) per carton.

H4069

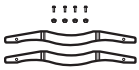

GANGING CONNECTORS

(hardware included)

DIMENSIONS

| | |
|--------------|------|
| Ship Weight: | 2 Ⓢ |
| Cube: | 0.05 |

LIST PRICE

\$69.00

NOTES: Specify Chairs frame color: Black (T)

! For use on models H4071, H4073, H4091 and H4093.

HOW TO SPECIFY

| | | | |
|--|---|---|---|
| <p>Select Model Number</p> <p>See page 413</p> <p><i>Specify for model H4099 only</i></p> <p>H 4 0 7 9 .</p> <p>H 4 0 9 9 .</p> | <p>Select Finish Color</p> <p>See page 413</p> <p><i>Specify for model H4099 only</i></p> <p>H .</p> | <p>Select Fabric</p> <p>See page 413</p> <p>C U 1 0 .</p> <p>C U 1 0 .</p> | <p>Select Frame</p> <p>T Black</p> <p>T1 Platinum Metallic</p> <p>T</p> <p>T</p> |
|--|---|---|---|

PARK AVENUE COLLECTION® 5000 SERIES

Want to see more? Scan here
to check out hon.com.



Park Avenue Executive High-Back Chair
shown with 94000 Series™ Desk and Credenza.

PARK AVENUE COLLECTION® 5000 SERIES

Park Avenue seating is your address for elegance. Task chairs feature inlaid wood accents, as well as an elegant tuxedo back design that creates a sophisticated look.



TASK CHAIR FEATURES

- Mid-range knee-tilt mechanism allows for a natural, comfortable recline.
- Pneumatic seat height adjustment moves the seat up and down to adapt to various body heights.
- Tilt tension controls the rate and ease of recline.
- Tilt lock allows the user to lock out the tilt function.
- Arms feature a urethane top pad.
- Base features a steel substrate with hardwood base caps.
- Warranted for users up to 275 lbs.

PARK AVENUE COLLECTION®

5000 Series Options

MODEL OPTIONS

H5001



Executive High-Back

Pneumatic, Swivel, Mid-range
Knee Tilt, Tilt Tension, Tilt Lock,
Open Loop Arms

H5002



Managerial Mid-Back

Pneumatic, Swivel, Mid-range
Knee Tilt, Tilt Tension, Tilt Lock,
Open Loop Arms

AVAILABLE FINISHES

Park Avenue Collection® 5000 Series
Seating is available in 8 wood finishes.

WOOD FINISHES

Bourbon Cherry (H)

Cognac (COGN)

Harvest (C)

Mahogany (N)

Mocha (MOCH)

Natural Maple (D)

Pinnacle (PINC)

Shaker Cherry (F)

HON BRANDED FABRICS

GRADE 1

Apex
Centurion
Compass
Contourett
Dapper
Ensemble
Hamilton
Inertia
Optic
Pebble

GRADE 2

Appoint Seating
Clyde
Dotty
Rush
Seed
Spin Seating
Whisper Vinyl

GRADE 3

Moxie
Parker
Purl

GRADE L

Denver Leather

For a complete list of fabrics, including partnership fabrics, go to hon.com/fabricsandfinishes.

Reference Fabric Color Combinations on pages 18-22 for color codes and legend on page 19 for lead times. For additional HON to Supply COM fabric grade pricing, go to honready.hon.com and click on the HON to Supply COM link.



PARK AVENUE COLLECTION® 5000 Series

H5001



EXECUTIVE HIGH-BACK

- Pneumatic
- Swivel
- Mid-range Knee Tilt
- Tilt Tension
- Tilt Lock
- Open Loop Arms

Functions: **A, E, G, K, L**
(Function Key on pages 212-213)

DIMENSIONS

| | | | |
|--------------|--------------------------------|-----------------------|--|
| Depth: | 29 | Arm Width: | 20 |
| Width: | 26 | Seat to Floor Height: | 17 ³ / ₄ -22 ¹ / ₂ |
| Height: | 44 ¹ / ₂ | Usable Seat Depth: | 17 ⁵ / ₈ |
| Seat Depth: | 19 ¹ / ₂ | Ship Weight: | 61 |
| Seat Width: | 20 | Cube: | 23.7 |
| Back Width: | 20 | COM: | 3.0 |
| Back Height: | 26 ¹ / ₄ | Weight Rating: | 250 lbs. |

FABRIC PRICE CODES

| | | | |
|----------|---------------|-----------|---------------|
| 1 | \$1185 | 8 | \$1599 |
| 2 | \$1257 | 9 | \$1653 |
| 3 | \$1329 | 10 | \$1707 |
| 4 | \$1383 | 11 | \$1761 |
| 5 | \$1437 | 12 | \$1815 |
| 6 | \$1491 | L | \$1785 |
| 7 | \$1545 | | |

NOTES: Arms are selected hardwood with urethane top pads.

H5002



MANAGERIAL MID-BACK

- Pneumatic
- Swivel
- Mid-range Knee Tilt
- Tilt Tension
- Tilt Lock
- Open Loop Arms

Functions: **A, E, G, K, L**
(Function Key on pages 212-213)

DIMENSIONS

| | | | |
|--------------|--------------------------------|-----------------------|--|
| Depth: | 29 | Arm Width: | 20 |
| Width: | 26 | Seat to Floor Height: | 17 ³ / ₄ -22 ¹ / ₂ |
| Height: | 39 ¹ / ₂ | Usable Seat Depth: | 17 ⁵ / ₈ |
| Seat Depth: | 19 ¹ / ₂ | Ship Weight: | 57 |
| Seat Width: | 20 | Cube: | 18.5 |
| Back Width: | 20 | COM: | 2.5 |
| Back Height: | 19 ¹ / ₄ | Weight Rating: | 250 lbs. |

FABRIC PRICE CODES

| | | | |
|----------|---------------|-----------|---------------|
| 1 | \$1155 | 8 | \$1500 |
| 2 | \$1215 | 9 | \$1545 |
| 3 | \$1275 | 10 | \$1590 |
| 4 | \$1320 | 11 | \$1635 |
| 5 | \$1365 | 12 | \$1680 |
| 6 | \$1410 | L | \$1655 |
| 7 | \$1455 | | |

NOTES: Arms are selected hardwood with urethane top pads.

HON Recommendation: H5001.MOCH.CU__ - List Price \$1185

HOW TO SPECIFY

| | | |
|---|---|---|
| <p>Select Model Number</p> <div style="border: 1px solid black; display: flex; justify-content: space-between; padding: 2px;"> H5001 </div> | <p>Select Finish</p> <p>See page 420</p> <div style="border: 1px solid black; display: flex; justify-content: space-between; padding: 2px;"> MOCH </div> | <p>Select Fabric</p> <p>See page 420</p> <div style="border: 1px solid black; display: flex; justify-content: space-between; padding: 2px;"> CU10 </div> |
|---|---|---|

PERCH™ Active Seating

OPEN MARKET



Icon Legend on page 17

HVLPERCH *

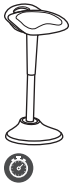

PERCH STOOL

Pneumatic
Swivel
Pivot Base

DIMENSIONS

| | | | |
|-------------|-----|-----------------------|-------------|
| Depth: | 16½ | Seat to Floor Height: | 23¾-35 |
| Width: | 15¾ | Usable Seat Depth: | 14½ |
| Seat Depth: | 14½ | Ship Weight: | 22 Ⓢ |
| Seat Width: | 14½ | Cube: | 3.13 |
| | | Weight Rating: | 250 lbs. |

PRICE CODE

Fabric **\$581**

NOTES: Fabric seat in Black and Charcoal. Built-in handle. Active pivot base. Silver frame. **HON 5-Year Limited Warranty.**

HON Recommendation: HVLPERCH.ASF10.X - List Price \$581

HVL991

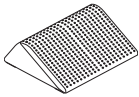

FOOTREST

Anti-Slip Cover

DIMENSIONS

| | | | |
|---------|-----|----------------|------------|
| Depth: | 13¾ | Ship Weight: | 7 Ⓢ |
| Width: | 16 | Cube: | 0.9 |
| Height: | 5½ | Weight Rating: | 250 lbs. |

LIST PRICE

\$89

! Available in Black (T) finish ONLY. **HON 5-Year Limited Warranty.**

SPECIFYING EXAMPLE: HVL991.T

SEATING

* De-emphasized

HOW TO SPECIFY

| | | |
|--|--|---|
| <p>Select Model Number</p> <p>H V L P E R C H .</p> | <p>Select Fabric</p> <p>ASF10 Black Fabric ASF19 Charcoal Fabric</p> <p>A S F 1 0 .</p> | <p>Select Frame</p> <p>X Silver</p> <p>X</p> |
|--|--|---|

PERPETUAL[®] NESTING CHAIRS

Want to see more? Scan here
to check out hon.com.



Perpetual Nesting Chairs and Huddle[®] Tables.

PERPETUAL[®] NESTING CHAIRS

Provide full-time comfort to even part-time workers with the Perpetual line of multi-purpose seating. The flip-up seat design maximizes space by allowing Perpetual to be easily nested. The passive back design moves with the user to deliver added comfort for all day meetings. Save space without sacrificing comfort with Perpetual.



FEATURES

- Flip-up seat allows chairs to nest and save floor space.
- Backrest reclines for added comfort.
- Tube rolled steel frame adds durability.
- Underside of seat is fully-upholstered for a clean appearance when nested.
- All-surface casters roll effortlessly and silently.
- Available in hundreds of quality HON fabrics.
- Warranted for users up to 300 lbs.

PERPETUAL[®] Nesting Chairs Options

MODEL OPTIONS

HPN1



Nesting Chair (Flex-back)

Armless, Four Legs

HPN2



Nesting Chair (Flex-back)

Fixed Arms, Four Legs

CASTER/ GLIDE



| CODE | DESCRIPTION | PRICE |
|----------|-------------|--------------|
| A | All-Surface | +\$0 |
| G | Bell Glide | +\$25 |

FRAME

| CODE | DESCRIPTION | PRICE |
|-----------|-------------------|-------------|
| T | Black | +\$0 |
| T1 | Platinum Metallic | +\$0 |

BACK STYLE



| CODE | DESCRIPTION | PRICE |
|-----------|------------------|-------------|
| UU | Upholstered Back | +\$0 |

HON BRANDED FABRICS

GRADE 1

Apex
Attire
Centurion
Compass
Contourett
Dapper
Ensemble
Hamilton
Inertia
Optic
Pebble

GRADE 2

Appoint Seating
Blume
Clyde
Dotty
Rush
Seed
Spin Seating
Whisper Vinyl

GRADE 3

Moxie
Parker
Purl
Quill

For a complete list of fabrics, including partnership fabrics, go to honesty.com/fabricsandfinishes.

Reference Fabric Color Combinations on pages 18-22 for color codes and legend on page 19 for lead times. For additional HON to Supply COM fabric grade pricing, go to honesty.com and click on the HON to Supply COM link.



PERPETUAL[®] Nesting Chairs

HPN1



Model HPN1AUU shown

NESTING CHAIR

Flex-back
Armless
Four Legs

DIMENSIONS

| | | | |
|--------------|------------------|-----------------------|------------------|
| Depth: | 26 | Seat to Floor Height: | 19 $\frac{1}{8}$ |
| Width: | 26 | Usable Seat Depth: | 16 $\frac{1}{2}$ |
| Height: | 36 | Ship Weight: | 38 |
| Seat Depth: | 17 $\frac{3}{4}$ | Cube: | 15.2 |
| Seat Width: | 17 | COM: | 1.5 |
| Back Width: | 17 $\frac{1}{2}$ | Weight Rating: | 300 lbs. |
| Back Height: | 15 $\frac{3}{4}$ | | |

FABRIC PRICE CODES

| | | | |
|---|-------|----|--------|
| 1 | \$774 | 8 | \$981 |
| 2 | \$810 | 9 | \$1008 |
| 3 | \$846 | 10 | \$1035 |
| 4 | \$873 | 11 | \$1062 |
| 5 | \$900 | 12 | \$1089 |
| 6 | \$927 | L | — |
| 7 | \$954 | | |

HPN2



Model HPN2AUU shown

NESTING CHAIR

Flex-back
Fixed Arms
Four Legs

DIMENSIONS

| | | | |
|--------------|------------------|-----------------------|------------------|
| Depth: | 26 | Arm Width: | 20 $\frac{3}{4}$ |
| Width: | 26 | Seat to Floor Height: | 19 $\frac{1}{8}$ |
| Height: | 36 | Usable Seat Depth: | 16 $\frac{1}{2}$ |
| Seat Depth: | 17 $\frac{3}{4}$ | Ship Weight: | 41 |
| Seat Width: | 17 | Cube: | 15.2 |
| Back Width: | 17 $\frac{1}{2}$ | COM: | 1.5 |
| Back Height: | 15 $\frac{3}{4}$ | Weight Rating: | 300 lbs. |

FABRIC PRICE CODES

| | | | |
|---|--------|----|--------|
| 1 | \$856 | 8 | \$1063 |
| 2 | \$892 | 9 | \$1090 |
| 3 | \$928 | 10 | \$1117 |
| 4 | \$955 | 11 | \$1144 |
| 5 | \$982 | 12 | \$1171 |
| 6 | \$1009 | L | — |
| 7 | \$1036 | | |

HOW TO SPECIFY

| | | | | |
|---|--|---|--|---|
| <p>Select Model Number</p> <p>HPN1</p> | <p>Select Caster/Glide</p> <p>A All-Surface G Glide (+ \$25)</p> <p>A</p> | <p>Select Back Type</p> <p>UU Upholstered Back</p> <p>UU</p> | <p>Select Fabric</p> <p>Note: For models with upholstered back, seat and back are always matching fabric See page 424</p> <p>CU10</p> | <p>Select Frame</p> <p>T Black T1 Platinum Metallic</p> <p>T</p> |
|---|--|---|--|---|

PILLOW-SOFT® 2090 SERIES

Want to see more? Scan here
to check out hon.com.



Pillow-Soft High-Back Executive and Sled Base Guest Chairs shown with 10700 Series™ desks.

PILLOW-SOFT® 2090 SERIES

Pillow-Soft chairs combine comfort, style and selection to deliver the ultimate seating experience. Each executive chair in the collection combines thick memory foam cushioning with built-in lumbar support to reduce fatigue and increase comfort. Besides the full body support, it adds an authoritative presence to the office. The plush tufted leather or fabric will add a touch of sophistication to your office.



FEATURES

- Responsive memory foam eliminates pressure points and provides lasting comfort.
- Loop arms relieve stress on the shoulder and neck.
- Fully-upholstered outer back.
- Memory foam seat cushion reduces pressure points and responds to contours of the body for lasting comfort.
- Task chairs come standard with pneumatic seat height adjustment, tilt, tilt tension and tilt lock.
- Dual-wheel casters roll effortlessly and silently.
- Warranted for users up to 300 lbs.
- H2095 model warranted for users up to 275 lbs.

PILLOW-SOFT® 2090 Series Options

MODEL OPTIONS

H2091



Executive High-Back

Pneumatic, Swivel, Tilt, Tilt Tension, Tilt Lock, Arms

H2095



Executive High-Back

Pneumatic, Swivel, Tilt, Tilt Tension, Tilt Lock, Arms

H2092



Managerial Mid-Back

Pneumatic, Swivel, Tilt, Tilt Tension, Tilt Lock, Arms

H2093



Guest Chair

Sled Base, Arms

CASTERS



| CODE | DESCRIPTION | PRICE |
|----------|-------------------|-------------|
| H | Black Hard Caster | +\$0 |



| | | |
|----------|--------------------------|--------------|
| S | Black All-Surface Caster | +\$40 |
|----------|--------------------------|--------------|

HON BRANDED FABRICS

GRADE 1

Apex
Black Vinyl
Burgundy Vinyl
Centurion
Compass
Contourett
Dapper
Ensemble
Hamilton
Inertia
Optic
Pebble

GRADE 2

Appoint Seating
Blume
Clyde
Dotty
Rush
Seed
Spin Seating
Whisper Vinyl

GRADE 3

Moxie
Parker
Purl
Quill

For a complete list of fabrics, including partnership fabrics, go to hon.com/fabricsandfinishes.

Reference Fabric Color Combinations on pages 18-22 for color codes and legend on page 19 for lead times. For additional HON to Supply COM fabric grade pricing, go to honready.hon.com and click on the HON to Supply COM link.

PILLOW-SOFT® 2090 Series

GSA SIN 33721 EXCEPT AS NOTED



Icon Legend on page 17

H2091



EXECUTIVE HIGH-BACK

Pneumatic
Swivel
Tilt
Tilt Tension
Tilt Lock
Arms
Functions: **A, E, F, K, L**
(Function Key on pages 212-213)

DIMENSIONS

Depth: 29¾
Width: 26¼
Height: 46½
Seat Depth: 21
Seat Width: 22
Back Width: 22
Back Height: 25
Arm Width: 20¼
Seat to Floor Height: 16¾-21¼
Usable Seat Depth: 18½
Ship Weight: 57
Cube: 16.0
COM: 3.0
Weight Rating: 300 lbs.

FABRIC PRICE CODES

| | | | |
|---|--------|----|--------|
| 1 | \$718 | 8 | \$1132 |
| 2 | \$790 | 9 | \$1186 |
| 3 | \$862 | 10 | \$1240 |
| 4 | \$916 | 11 | \$1294 |
| 5 | \$970 | 12 | \$1348 |
| 6 | \$1024 | L | \$868 |
| 7 | \$1078 | | |

NOTES: When selecting leather, the 2090 Series uses SR Leather only. All models are also available in Grade 1 EB vinyl (which matches SR Leather).

H2095



OPEN MARKET

EXECUTIVE HIGH-BACK

Pneumatic
Swivel
Tilt
Tilt Tension
Tilt Lock
Padded Loop Arms
Functions: **A, E, F, K, L**
(Function Key on pages 212-213)

DIMENSIONS

Depth: 29½
Width: 26¾
Height: 47½
Seat Depth: 17½
Seat Width: 21
Back Width: 21
Back Height: 29½
Arm Width: 21
Seat to Floor Height: 16-21
Usable Seat Depth: 17½
Ship Weight: 57
Cube: 7.1
COM: N/A
Weight Rating: 275 lbs.

FABRIC PRICE CODES

Fabric
PWST10 \$568 (Black)
Black Bonded Leather
PWST11 \$588 (Black)

NOTES: When selecting upholstery, the H2095 is only available in PWST10 (Black fabric) and PWST11 (Black Bonded Leather).

H2092



MANAGERIAL MID-BACK

Pneumatic
Swivel
Tilt
Tilt Tension
Tilt Lock
Arms
Functions: **A, E, F, K, L**
(Function Key on pages 212-213)

DIMENSIONS

Depth: 28¾
Width: 26¼
Height: 41¾
Seat Depth: 21
Seat Width: 22
Back Width: 22
Back Height: 19¾
Arm Width: 20¼
Seat to Floor Height: 16¾-21¼
Usable Seat Depth: 18½
Ship Weight: 54
Cube: 16.0
COM: 3.0
Weight Rating: 300 lbs.

FABRIC PRICE CODES

| | | | |
|---|--------|----|--------|
| 1 | \$686 | 8 | \$1100 |
| 2 | \$758 | 9 | \$1154 |
| 3 | \$830 | 10 | \$1208 |
| 4 | \$884 | 11 | \$1262 |
| 5 | \$938 | 12 | \$1316 |
| 6 | \$992 | L | \$836 |
| 7 | \$1046 | | |

NOTES: When selecting leather, the 2090 Series uses SR Leather only. All models are also available in Grade 1 EB vinyl (which matches SR Leather).

H2093



GUEST CHAIR

Sled Base
Arms

DIMENSIONS

Depth: 27¾
Width: 23¼
Height: 36
Seat Depth: 21½
Seat Width: 20¾
Back Width: 21½
Back Height: 19¼
Arm Width: 19¾
Seat to Floor Height: 19½
Usable Seat Depth: 19
Ship Weight: 38
Cube: 16.1
COM: 2.5
Weight Rating: 300 lbs.

FABRIC PRICE CODES

| | | | |
|---|-------|----|--------|
| 1 | \$548 | 8 | \$893 |
| 2 | \$608 | 9 | \$938 |
| 3 | \$668 | 10 | \$983 |
| 4 | \$713 | 11 | \$1028 |
| 5 | \$758 | 12 | \$1073 |
| 6 | \$803 | L | \$698 |
| 7 | \$848 | | |

NOTES: When selecting leather, the 2090 Series uses SR Leather only. All models are also available in Grade 1 EB vinyl (which matches SR Leather).

HOW TO SPECIFY

HON Recommendation: H2091.H.SR11.T - List Price \$868

| | | | |
|--|--|--|--|
| <p>Select Model Number</p> <p>H 2 0 9 1 .</p> | <p>Select Caster</p> <p>H Black Hard Caster S Black All-Surface Caster (+ \$40) <i>Does not apply to models H2093 or H2095</i></p> <p>H .</p> | <p>Select Fabric</p> <p>See page 427 <i>H2095 only available in 2 fabric options. See above for pricing and selection.</i></p> <p>S R 1 1 .</p> | <p>Select Frame</p> <p>T Black</p> <p>T</p> |
|--|--|--|--|

PILLOW-SOFT® 2190 SERIES

Want to see more? Scan here
to check out hon.com.



Pillow-Soft Executive High-Back and Guest Chairs shown with Park Avenue Collection® Laminate desks.

PILLOW-SOFT® 2190 SERIES

Pillow-Soft chairs combine comfort, style and selection to deliver the ultimate seating experience. Each executive chair in the collection combines thick memory foam cushioning with built-in lumbar support to reduce fatigue and increase comfort. Besides the full body support, it adds an authoritative presence to the office. The plush tufted leather or fabric and optional hardwood accents will add a touch of sophistication to your office.



FEATURES

- Responsive memory foam eliminates pressure points and provides lasting comfort.
- Loop arms relieve stress on the shoulder and neck.
- Fully-upholstered outer back.
- Base features a steel substrate with hardwood base caps.
- Memory foam seat cushion reduces pressure points and responds to contours of the body for lasting comfort.
- Dual-wheel casters roll effortlessly and silently.
- Solid hardwood in one of eight attractive finishes.
- Warranted for users up to 275 lbs.

PILLOW-SOFT® 2190 Series Options

MODEL OPTIONS

H2191



Executive High-Back

Pneumatic, Swivel, Tilt, Tilt Tension, Tilt Lock, Open Padded Loop Arms

H2192



Managerial Mid-Back

Pneumatic, Swivel, Tilt, Tilt Tension, Tilt Lock, Open Padded Loop Arms

H2194



Guest Chair

4-Leg Base, Open Loop Arms

AVAILABLE FINISHES

Pillow-Soft® 2190 Series Seating is available in 8 wood finishes.

WOOD FINISHES

Bourbon Cherry (H)

Cognac (COGN)

Harvest (C)

Mahogany (N)

Mocha (MOCH)

Natural Maple (D)

Pinnacle (PINC)

Shaker Cherry (F)

HON BRANDED FABRICS

GRADE 1

Apex
Black Vinyl
Burgundy Vinyl
Centurion
Compass
Contourett
Dapper
Ensemble
Hamilton
Inertia
Optic
Pebble

GRADE 2

Appoint Seating
Blume
Clyde
Dotty
Rush
Seed
Spin Seating
Whisper Vinyl

GRADE 3

Moxie
Parker
Purl
Quill

For a complete list of fabrics, including partnership fabrics, go to hon.com/fabricsandfinishes.

Reference Fabric Color Combinations on pages 18-22 for color codes and legend on page 19 for lead times. For additional HON to Supply COM fabric grade pricing, go to honready.hon.com and click on the HON to Supply COM link.



PILLOW-SOFT® 2190 Series

H2191



EXECUTIVE HIGH-BACK

Pneumatic
Swivel
Tilt
Tilt Tension
Tilt Lock
Open Padded Loop Arms
Functions: **A, E, F, K, L**
(Function Key on pages 212-213)

DIMENSIONS

Depth: 29¾
Width: 26¼
Height: 46½
Seat Depth: 21
Seat Width: 22
Back Width: 22
Back Height: 25
Arm Width: 22¼
Seat to Floor Height: 16¾-21¼
Usable Seat Depth: 18½
Ship Weight: 60
Cube: 16.0
COM: 3.0
Weight Rating: 250 lbs.

FABRIC PRICE CODES

| | | | |
|---|--------|----|--------|
| 1 | \$1126 | 8 | \$1540 |
| 2 | \$1198 | 9 | \$1594 |
| 3 | \$1270 | 10 | \$1648 |
| 4 | \$1324 | 11 | \$1702 |
| 5 | \$1378 | 12 | \$1756 |
| 6 | \$1432 | L | \$1276 |
| 7 | \$1486 | | |

NOTES: Arms are laminated hardwood with urethane top pads. Also available in Grade 1 vinyl EB11 and EB69. (EB matching vinyl used with SR Leather).

H2192



MANAGERIAL MID-BACK

Pneumatic
Swivel
Tilt
Tilt Tension
Tilt Lock
Open Padded Loop Arms
Functions: **A, E, F, K, L**
(Function Key on pages 212-213)

DIMENSIONS

Depth: 28¾
Width: 26¼
Height: 41¾
Seat Depth: 21
Seat Width: 22
Back Width: 22
Back Height: 19⅝
Arm Width: 22¼
Seat to Floor Height: 16¾-21¼
Usable Seat Depth: 18½
Ship Weight: 57
Cube: 16.0
COM: 2.5
Weight Rating: 250 lbs.

FABRIC PRICE CODES

| | | | |
|---|--------|----|--------|
| 1 | \$1095 | 8 | \$1440 |
| 2 | \$1155 | 9 | \$1485 |
| 3 | \$1215 | 10 | \$1530 |
| 4 | \$1260 | 11 | \$1575 |
| 5 | \$1305 | 12 | \$1620 |
| 6 | \$1350 | L | \$1245 |
| 7 | \$1395 | | |

NOTES: Arms are laminated hardwood with urethane top pads. Also available in Grade 1 vinyl EB11 and EB69. (EB matching vinyl used with SR Leather).

H2194



GUEST CHAIR

4-Leg Base
Open Loop Arms

DIMENSIONS

Depth: 27½
Width: 23¼
Height: 35½
Seat Depth: 21½
Seat Width: 20¾
Back Width: 21½
Back Height: 19¼
Arm Width: 19¾
Seat to Floor Height: 19½
Usable Seat Depth: 19
Ship Weight: 49
Cube: 17.3
COM: 2.5
Weight Rating: 250 lbs.

FABRIC PRICE CODES

| | | | |
|---|--------|----|--------|
| 1 | \$891 | 8 | \$1236 |
| 2 | \$951 | 9 | \$1281 |
| 3 | \$1011 | 10 | \$1326 |
| 4 | \$1056 | 11 | \$1371 |
| 5 | \$1101 | 12 | \$1416 |
| 6 | \$1146 | L | \$1041 |
| 7 | \$1191 | | |

NOTES: Guest Chairs available in 4-Leg Base. Also available in Grade 1 vinyl EB11 and EB69. (EB matching vinyl used with SR Leather).

HON Recommendation: H2191.MOCH.CU__ - List Price \$1126

HOW TO SPECIFY

| | | |
|--|--|--|
| <p>Select Model Number</p> <p>H 2 1 9 1</p> | <p>Select Finish</p> <p>See page 430</p> <p>M O C H</p> | <p>Select Fabric</p> <p>See page 430</p> <p>C U 1 0</p> |
|--|--|--|

PROMINENT™ Mesh Chairs

OPEN MARKET



Icon Legend on page 17

HVL531



HIGH-BACK

Pneumatic
Swivel
Tilt
Tilt Tension
Tilt Lock
Height-adjustable Arms

Functions: **A, E, F, K, L, Q**
(Function Key on pages 212-213)

DIMENSIONS

| | | | |
|--------------|-----|-----------------------|----------|
| Depth: | 27 | Arm Width: | 20¼ |
| Width: | 27 | Seat to Floor Height: | 18-22 |
| Height: | 42½ | Usable Seat Depth: | 18 |
| Seat Depth: | 18 | Ship Weight: | 36 |
| Seat Width: | 21½ | Cube: | 5.1 |
| Back Width: | 18¾ | Weight Rating: | 250 lbs. |
| Back Height: | 23 | | |

PRICE CODE

| | |
|----------------------|--------------|
| Sandwich Mesh | \$451 |
| Leather | \$476 |

NOTES: Comfortable and breathable mesh back. Black Sandwich Mesh or Black Bonded Leather seat. Black frame. Height-adjustable arms. **HON 5-Year Limited Warranty.**

HON Recommendation: HVL531.MM10 - List Price \$451

HVL532



HIGH-BACK

Mesh Back
Pneumatic
Swivel
Asynchronous Control
Tilt
Tilt Tension
Tilt Lock
Seat Glide Mechanism
Back Height Adjustment
Height and Width Adjustable Arms

Functions: **A, B, D, E, F, L, O, S**
(Function Key on pages 212-213)

DIMENSIONS

| | | | |
|-------------|---------|-----------------------|----------|
| Depth: | 26 | Back Height: | 23¼-24½ |
| Width: | 30¾ | Arm Width: | 18-22½ |
| Height: | 44½ | Seat to Floor Height: | 17-20½ |
| Seat Depth: | 17⅞-20⅞ | Ship Weight: | 50 |
| Seat Width: | 20½ | Cube: | 6.5 |
| Back Width: | 19⅞ | Weight Rating: | 250 lbs. |

PRICE CODE

| | |
|----------------------|--------------|
| Sandwich Mesh | \$536 |
| Leather | \$561 |

NOTES: Comfortable and breathable mesh back. Black Sandwich Mesh or Black Bonded Leather seat. Black frame. Height and width adjustable arms. Seat glide mechanism. Asynchronous control with independent seat and back angle adjustment. **HON 5-Year Limited Warranty.**

HON Recommendation: HVL532.MM10 - List Price \$536

HOW TO SPECIFY

Select
Model Number

Select
Fabric

MM10 Black Sandwich Mesh Fabric
SB11 Black Bonded Leather

H V L 5 3 1 .

M M 1 0



PROMINENT™ Mesh Chairs

HVL534



HIGH-BACK

Pneumatic
Swivel
Tilt
Tilt Tension
Tilt Lock
Height-adjustable Arms

Functions: **A, E, F, K, L, Q**
(Function Key on pages 212-213)

DIMENSIONS

| | | | |
|--------------|--------------------------------|-----------------------|--|
| Depth: | 27 | Arm Width: | 19 ⁵ / ₈ |
| Width: | 27 | Seat to Floor Height: | 17 ¹ / ₈ -20 ³ / ₄ |
| Height: | 41 ¹ / ₈ | Usable Seat Depth: | 19 ¹ / ₈ |
| Seat Depth: | 19 ¹ / ₈ | Ship Weight: | 40.6 Ⓢ |
| Seat Width: | 20 ¹ / ₈ | Cube: | 5.7 |
| Back Width: | 19 ¹ / ₈ | Weight Rating: | 250 lbs. |
| Back Height: | 22 ³ / ₈ | | |

PRICE CODE

Mesh \$553

NOTES: Prominent™ HVL534. Comfortable and breathable mesh back. Black Mesh seat. Height-adjustable arms. **HON 5-Year Limited Warranty.**

HON Recommendation: HVL534.MST3 - List Price \$553

HVL539



TASK STOOL

Mesh Back
Pneumatic
Swivel
Height and Width Adjustable
Arms
Adjustable Footring

Functions: **A, E, S**
(Function Key on pages 212-213)

DIMENSIONS

| | | | |
|--------------|----------------------------------|-----------------------|--|
| Depth: | 27 ⁹ / ₁₆ | Arm Width: | 18 ¹ / ₈ |
| Width: | 28 ¹⁷ / ₃₂ | Seat to Floor Height: | 21 ⁹ / ₃₂ -28 ⁵ / ₃₂ |
| Height: | 50 | Usable Seat Depth: | 17 ¹ / ₈ |
| Seat Depth: | 17 ¹ / ₈ | Ship Weight: | 44.0 Ⓢ |
| Seat Width: | 20 ¹⁵ / ₃₂ | Cube: | 5.7 |
| Back Width: | 17 ¹ / ₈ | Weight Rating: | 250 lbs. |
| Back Height: | 22 ²⁷ / ₃₂ | | |

PRICE CODE

Sandwich Mesh \$493

NOTES: Prominent™ HVL539. Black upholstered seat. Height and width adjustable arms. **HON 5-Year Limited Warranty.**

HON Recommendation: HVL539.MM10 - List Price \$493

HOW TO SPECIFY

Select
Model Number

H V L 5 3 4 .

Select
Fabric

MM10 Black Sandwich Mesh Fabric
Specify for model HVL539 only
MST3 Black Mesh
Specify for model HVL534 only

M S T 3



Ruck™ Seating shown with West Hill™ Casual Lounge, Scramble™ Occasional Tables, and Unika Vaev Screens.

RUCK™

Easy on the eyes and even easier to move and stack, Ruck™ seating brings effortless style to working alone or together.

Available in a variety of finishes in both seated and stool heights, Ruck clicks with its surroundings — whether that's in a collaborative area, café setting, or as a side chair in a private office. Crafted with gentle, molded contours, Ruck makes being on the edge of your seat a more comfortable place to be.



FEATURES

- Available in both a seated and stool-height option.
- Lightweight frame can be easily moved to rearrange seating configurations.
- Waterfall seat edge promotes better leg circulation.
- Glides move effortlessly on hard surfaces.
- Both the chair and stool stack six high on the floor to maximize space.
- Single piece shell can be quickly wiped down for easy maintenance.
- Choose from 6 laminate and 4 veneer shell colors.
- Legs are available in a variety of finish options to match or complement other HON product lines.
- Backed by HON's industry-leading Lifetime Warranty.

MODEL OPTIONS

HRUCK1L



Chair

Laminate Shell

HRUCK5L



Stool

Laminate Shell

HRUCK1W



Chair

Wood Shell

HRUCK5W



Stool

Wood Shell

AVAILABLE FINISHES

Ruck Seating is available in 6 laminate finishes and 4 wood finishes.

LAMINATE FINISHES

Charcoal (S)

Designer White (LDW1)

Florence Walnut (LFW1)

Kingswood Walnut (LK11)

Natural Maple (D)

Pinnacle (PINC)

WOOD FINISHES

Black Wash (QA997)

Natural (QA447)

Pinnacle Walnut (QA679)

White Wash (QA921)

FRAME

| CODE | DESCRIPTION | PRICE |
|------------|-------------------------|-------------|
| P6P | Textured Black Mica | +\$0 |
| P7J | Textured Brownstone | +\$0 |
| P7A | Textured Charcoal | +\$0 |
| PK7 | Textured Designer White | +\$0 |
| P7L | Textured Loft | +\$0 |
| P7M | Textured Muslin | +\$0 |
| P8V | Textured Titanium | +\$0 |

RUCK™ Laminate Seating

OPEN MARKET



Icon Legend on page 17

HRUCK1L



CHAIR, LAMINATE SHELL

DIMENSIONS

| | | | |
|--------------|---------------------------------|-----------------------|--------------------------------|
| Depth: | 22 ⁵ / ₈ | Seat to Floor Height: | 17 ³ / ₄ |
| Width: | 21 ⁵ / ₈ | Usable Seat Depth: | 18 ¹ / ₄ |
| Height: | 32 ⁵ / ₁₆ | Ship Weight: | 24 |
| Seat Depth: | 18 ¹ / ₄ | Cube: | 15.8 |
| Seat Width: | 17 ¹ / ₂ | Weight Rating: | 300 lbs. |
| Back Width: | 17 | | |
| Back Height: | 15 ⁵ / ₈ | | |

LIST PRICE

\$530

HRUCK5L



STOOL, LAMINATE SHELL

DIMENSIONS

| | | | |
|--------------|--------------------------------|-----------------------|--------------------------------|
| Depth: | 22 ⁵ / ₈ | Seat to Floor Height: | 30 |
| Width: | 21 ⁵ / ₈ | Usable Seat Depth: | 18 ¹ / ₄ |
| Height: | 44 ¹ / ₂ | Ship Weight: | 32 |
| Seat Depth: | 18 ¹ / ₄ | Cube: | 22.2 |
| Seat Width: | 17 ¹ / ₂ | Weight Rating: | 300 lbs. |
| Back Width: | 17 | | |
| Back Height: | 15 ⁵ / ₈ | | |

LIST PRICE

\$636

HON Recommendation: HRUCK1L.PINC.P8V - List Price \$530

SEATING

HOW TO SPECIFY

Select
Model Number

HRUCK1L .

Select
Laminate

See page 435

PINC .

Select
Frame

See page 435

P8V



Icon Legend on page 17

HRUCK1W



CHAIR, WOOD SHELL

DIMENSIONS

| | | | |
|--------------|---------------------------------|-----------------------|--------------------------------|
| Depth: | 22 ⁵ / ₈ | Seat to Floor Height: | 17 ³ / ₄ |
| Width: | 21 ⁵ / ₈ | Usable Seat Depth: | 18 ¹ / ₄ |
| Height: | 32 ⁵ / ₁₆ | Ship Weight: | 24 |
| Seat Depth: | 18 ¹ / ₄ | Cube: | 15.8 |
| Seat Width: | 17 ¹ / ₂ | Weight Rating: | 300 lbs. |
| Back Width: | 17 | | |
| Back Height: | 15 ⁵ / ₈ | | |

LIST PRICE

\$557

HRUCK5W



STOOL, WOOD SHELL

DIMENSIONS

| | | | |
|--------------|--------------------------------|-----------------------|--------------------------------|
| Depth: | 22 ⁵ / ₈ | Seat to Floor Height: | 30 |
| Width: | 21 ⁵ / ₈ | Usable Seat Depth: | 18 ¹ / ₄ |
| Height: | 44 ¹ / ₂ | Ship Weight: | 32 |
| Seat Depth: | 18 ¹ / ₄ | Cube: | 22.2 |
| Seat Width: | 17 ¹ / ₂ | Weight Rating: | 300 lbs. |
| Back Width: | 17 | | |
| Back Height: | 15 ⁵ / ₈ | | |

LIST PRICE

\$663

HON Recommendation: HRUCK1W.QA997.P8V - List Price \$557

HOW TO SPECIFY

| | | |
|--|--|---|
| <p>Select Model Number</p> <p>HRUCK1W</p> | <p>Select Finish</p> <p>See page 435</p> <p>QA997</p> | <p>Select Frame</p> <p>See page 435</p> <p>P8V</p> |
|--|--|---|



Ryder™ Sport Executive Chair with
Voi® Desks and Fuse™ Storage.

RYDER™

Take your comfort to the extreme, and elevate the entire office with this high energy chair. The Ryder™ executive chair is the sporty answer to your grandfather's office seating. The unexpected curves and unconventional styling create uncommon comfort. Black Bonded Leather paired with carbon fiber pattern creates a sleek look for any modern office.



FEATURES

- Synchro-tilt mechanism offers full range of reclining positions.
- Height-adjustable arms put the support right where you want it.
- Unique multi-panel upholstery.
- Backed by the HON 5-Year Limited Warranty.



HVL149



SPORT EXECUTIVE CHAIR

DIMENSIONS

LIST PRICE

| | | | |
|--|-----------------|-----------------------------|--------------|
| Pneumatic | Depth: 29 | Arm Width: 21 | \$581 |
| Swivel | Width: 27¾ | Seat to Floor Height: 18-22 | |
| Synchronized Tilt | Height: 52¼ | Usable Seat Depth: 19½ | |
| Tilt Tension | Seat Depth: 19½ | Ship Weight: 53 | |
| Tilt Lock | Seat Width: 23 | Cube: 8.5 | |
| Height-adjustable Arms | Back Width: 22 | Weight Rating: 250 lbs. | |
| Functions: A, E, J, K, L, Q | Back Height: 32 | | |
| <i>(Function Key on pages 212-213)</i> | | | |

NOTES: Black Bonded Leather with tailored stitching and mock carbon fiber detail. Black frame. Height-adjustable arms. Integrated headrest support. **HON 5-Year Limited Warranty.**

HON Recommendation: HVL149.SB11 - List Price \$581

HOW TO SPECIFY

| | |
|----------------------------|----------------------------------|
| Select Model Number | Select Fabric |
| | SB11 Black Bonded Leather |
| H V L 1 4 9 . | S B 1 1 |

SCATTER™ Guest Chairs

OPEN MARKET



Icon Legend on page 17

HVL606



GUEST CHAIR

Leg Base
Armless
Stacks up to Four High

DIMENSIONS

| | | | |
|--------------|-----|-----------------------|----------|
| Depth: | 21 | Seat to Floor Height: | 19 |
| Width: | 21¼ | Usable Seat Depth: | 17½ |
| Height: | 32¾ | Ship Weight: | 16 |
| Seat Depth: | 17½ | Cube: | 2.1 |
| Seat Width: | 19 | Weight Rating: | 250 lbs. |
| Back Width: | 18½ | | |
| Back Height: | 16 | | |

PRICE CODE

| | |
|----------------|--------------|
| Fabric | \$171 |
| Leather | \$201 |

NOTES: Fabric or Black Bonded Leather. Stackable up to four high. Round tube construction. Frame available in Black. Casters and glides ship packaged together for customer's assembly choice. **HON 5-Year Limited Warranty.**

HON Recommendation: HVL606.VA10 - List Price \$171

HVL616



GUEST CHAIR

Leg Base
Arms
Stacks up to Four High

DIMENSIONS

| | | | |
|--------------|-----|-----------------------|----------|
| Depth: | 21 | Arm Width: | 20⅝ |
| Width: | 23¾ | Seat to Floor Height: | 19 |
| Height: | 32¾ | Usable Seat Depth: | 17½ |
| Seat Depth: | 17½ | Ship Weight: | 18 |
| Seat Width: | 19 | Cube: | 2.1 |
| Back Width: | 18½ | Weight Rating: | 250 lbs. |
| Back Height: | 16 | | |

PRICE CODE

| | |
|----------------|--------------|
| Fabric | \$192 |
| Leather | \$222 |

NOTES: Fabric or Black Bonded Leather. Stackable up to four high. Round tube construction. Frame available in Black. Casters and glides ship packaged together for customer's assembly choice. **HON 5-Year Limited Warranty.**

HON Recommendation: HVL616.VA10 - List Price \$192

SEATING

HOW TO SPECIFY

Select
Model Number

Select
Fabric

- SB11** Black Bonded Leather
- VA10** Black Fabric
- VA19** Charcoal Fabric
- VA90** Navy Fabric

H V L 6 0 6 .

V A 1 0

SKIP

Want to see more? Scan here
to check out [hon.com](https://www.hon.com).



Skip shown with Flock® Cylinder Table.

SKIP

It's hard to get creative when you're feeling all buttoned up. That's why workplaces are adding less formal, more dynamic spaces to foster more creativity and connection between workers. Designed to put the fun back in functional, Skip seating offers an engaging, active sit that lets you rock a meeting — literally. When it comes to casual and collaborative seating that's as lively as it is practical, this chair doesn't Skip a beat.



FEATURES

- Built-in handle makes it easy to move around.
- Textured finish is durable, easy to clean, UV resistant, and suitable for outdoor sitting.
- Optional cushion stays in place but is not permanently affixed.
- Cushion fabric is easy to wipe clean.

SKIP Collaborative Chair

OPEN MARKET



Icon Legend on page 17

HQQ1



COLLABORATIVE CHAIR

DIMENSIONS

| | | | |
|--------------|-----|-----------------------|----------|
| Depth: | 35½ | Seat to Floor Height: | 17 |
| Width: | 28 | Usable Seat Depth: | 17 |
| Height: | 31 | Ship Weight: | 35 |
| Seat Depth: | 18 | Cube: | 20.0 |
| Seat Width: | 28 | Weight Rating: | 275 lbs. |
| Back Width: | 28 | | |
| Back Height: | 21 | | |

LIST PRICE

\$876

NOTES: HON 5-Year Limited Warranty.

HQQ1CUSH



CUSHION

DIMENSIONS

| | | | |
|---------|-----|--------------|-----|
| Depth: | 17½ | Ship Weight: | 5 |
| Width: | 25¾ | Cube: | 2.0 |
| Height: | 1½ | | |

LIST PRICE

\$169

NOTES: HON 5-Year Limited Warranty.

SEATING

HOW TO SPECIFY

Select Model Number

HQQ1

HOW TO SPECIFY

Select Model Number

HQQ1CUSH.

Select Fabric

SLT Slate
NVY Navy

SLT

SOLUTIONS SEATING® 4000 SERIES

Want to see more? Scan here
to check out hon.com.



Solutions Managerial Mid-Back Chair shown with
34000 Series Desk and Brigade® 700 Series Lateral Files.

SOLUTIONS SEATING® 4000 SERIES

Looking for the perfect answer for your task and guest chair needs? HON has four Solutions for everything from workstations to open areas. The Solutions series includes a high-back and mid-back task chair, as well as matching four-leg and sled base guest chairs. The floating backrest provides ergonomic support for your spine. The tilt mechanism delivers a natural recline. Solutions are the chairs that really live up to their name.



GUEST CHAIR FEATURES

- Guest chairs feature molded polymer outer back shell for added durability.
- Back cushion enhances lumbar support and minimizes fatigue.
- Available in hundreds of quality HON fabrics.
- Warranted for users up to 300 lbs.

TASK CHAIR FEATURES

- One-touch seat height adjustment easily moves the seat up and down.
- Tilt tension controls the rate and ease of recline.
- Tilt lock allows the user to lock out the tilt function.
- 360-degree swivel provides freedom of movement in any direction.
- Model H4001 has a fully-upholstered outer back.
- Model H4002 has a molded polymer outer back shell.
- Back cushion enhances lumbar support and minimizes fatigue.
- Dual-wheeled casters roll effortlessly and quietly.
- Available in hundreds of quality HON fabrics.
- Warranted for users up to 300 lbs.

SOLUTIONS SEATING®

4000 Series Options

MODEL OPTIONS

H4001



Executive High-Back

Pneumatic, Swivel, Tilt, Tilt Tension, Tilt Lock, Loop Arms

H4002



Managerial Mid-Back

Pneumatic, Swivel, Tilt, Tilt Tension, Tilt Lock, Loop Arms

H4003



Guest Chair

Leg Base, Arms

H4008



Guest Chair

Sled Base, Arms

CASTERS



| CODE | DESCRIPTION | PRICE |
|------|-------------------|-------------|
| H | Black Hard Caster | +\$0 |



| | | |
|---|--------------------------|--------------|
| S | Black All-Surface Caster | +\$40 |
|---|--------------------------|--------------|

*Specify for models H4001 and H4002 only

FRAME

| CODE | DESCRIPTION | PRICE |
|------|-------------|-------------|
| T | Black | +\$0 |

HON BRANDED FABRICS

GRADE 1

Apex
Attire
Centurion
Compass
Contourett
Dapper
Ensemble
Hamilton
Inertia
Optic
Pebble

GRADE 2

Appoint Seating
Blume
Clyde
Dotty
Rush
Seed
Spin Seating
Whisper Vinyl

GRADE 3

In Season
Moxie
Parker
Purl
Quill

For a complete list of fabrics, including partnership fabrics, go to hon.com/fabricsandfinishes.

Reference Fabric Color Combinations on pages 18-22 for color codes and legend on page 19 for lead times. COM yardage shown is for Pattern Cut only. Contact Customer Service for Railroaded yardage requirements. For additional HON to Supply COM fabric grade pricing, go to honready.hon.com and click on the HON to Supply COM link.



SOLUTIONS SEATING®

4000 Series

H4001



EXECUTIVE HIGH-BACK

- Pneumatic
- Swivel
- Tilt
- Tilt Tension
- Tilt Lock
- Loop Arms

Functions: **A, E, F, K, L**
 (Function Key on pages 212-213)

DIMENSIONS

| | | | |
|--------------|-----|-----------------------|----------|
| Depth: | 27 | Arm Width: | 20¼ |
| Width: | 26 | Seat to Floor Height: | 16¾-21¾ |
| Height: | 39½ | Usable Seat Depth: | 17¾ |
| Seat Depth: | 18 | Ship Weight: | 45 |
| Seat Width: | 20 | Cube: | 10.3 |
| Back Width: | 20½ | COM: | 1.5 |
| Back Height: | 20¾ | Weight Rating: | 250 lbs. |

FABRIC PRICE CODES

| | | | |
|---|-------|----|-------|
| 1 | \$540 | 8 | \$747 |
| 2 | \$576 | 9 | \$774 |
| 3 | \$612 | 10 | \$801 |
| 4 | \$639 | 11 | \$828 |
| 5 | \$666 | 12 | \$855 |
| 6 | \$693 | L | — |
| 7 | \$720 | | |

H4002

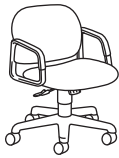

MANAGERIAL MID-BACK

- Pneumatic
- Swivel
- Tilt
- Tilt Tension
- Tilt Lock
- Loop Arms

Functions: **A, E, F, K, L**
 (Function Key on pages 212-213)

DIMENSIONS

| | | | |
|--------------|-----|-----------------------|----------|
| Depth: | 26¼ | Arm Width: | 18¾ |
| Width: | 26 | Seat to Floor Height: | 16¾-21¾ |
| Height: | 35½ | Usable Seat Depth: | 17¾ |
| Seat Depth: | 18 | Ship Weight: | 38 |
| Seat Width: | 20 | Cube: | 8.6 |
| Back Width: | 21 | COM: | 1.0 |
| Back Height: | 15 | Weight Rating: | 250 lbs. |

FABRIC PRICE CODES

| | | | |
|---|-------|----|-------|
| 1 | \$481 | 8 | \$619 |
| 2 | \$505 | 9 | \$637 |
| 3 | \$529 | 10 | \$655 |
| 4 | \$547 | 11 | \$673 |
| 5 | \$565 | 12 | \$691 |
| 6 | \$583 | L | — |
| 7 | \$601 | | |

H4003



GUEST CHAIR

- Leg Base
- Arms

DIMENSIONS

| | | | |
|--------------|-----|-----------------------|----------|
| Depth: | 24½ | Arm Width: | 18¾ |
| Width: | 23½ | Seat to Floor Height: | 19¼ |
| Height: | 32 | Usable Seat Depth: | 18¼ |
| Seat Depth: | 18 | Ship Weight: | 29 |
| Seat Width: | 20 | Cube: | 12.6 |
| Back Width: | 21 | COM: | 1.0 |
| Back Height: | 15 | Weight Rating: | 250 lbs. |

FABRIC PRICE CODES

| | | | |
|---|-------|----|-------|
| 1 | \$364 | 8 | \$502 |
| 2 | \$388 | 9 | \$520 |
| 3 | \$412 | 10 | \$538 |
| 4 | \$430 | 11 | \$556 |
| 5 | \$448 | 12 | \$574 |
| 6 | \$466 | L | — |
| 7 | \$484 | | |

H4008



GUEST CHAIR

- Sled Base
- Arms

DIMENSIONS

| | | | |
|--------------|-----|-----------------------|----------|
| Depth: | 25½ | Arm Width: | 19 |
| Width: | 23½ | Seat to Floor Height: | 19¼ |
| Height: | 32½ | Usable Seat Depth: | 18¼ |
| Seat Depth: | 18 | Ship Weight: | 33 |
| Seat Width: | 20 | Cube: | 12.6 |
| Back Width: | 21 | COM: | 1.0 |
| Back Height: | 15 | Weight Rating: | 250 lbs. |

FABRIC PRICE CODES

| | | | |
|---|-------|----|-------|
| 1 | \$407 | 8 | \$545 |
| 2 | \$431 | 9 | \$563 |
| 3 | \$455 | 10 | \$581 |
| 4 | \$473 | 11 | \$599 |
| 5 | \$491 | 12 | \$617 |
| 6 | \$509 | L | — |
| 7 | \$527 | | |

HON Recommendation: H4001.H.CU__T - List Price \$540
H4008.CU__T - List Price \$407

HOW TO SPECIFY

| | | | |
|--|---|---|--|
| <p>Select Model Number</p> <p>H 4 0 0 8 .</p> | <p>Select Caster</p> <p>H Black Hard Caster S Black All-Surface Caster (+ \$40) Specify for models H4001 and H4002 only</p> <p>H .</p> | <p>Select Fabric</p> <p>See page 444</p> <p>CU10 .</p> | <p>Select Frame</p> <p>T Black</p> <p>T</p> |
|--|---|---|--|



Solve Task Chairs and Stools.

SOLVE®

If you want to make a powerful statement, simply have a seat. With three back materials and an optional adjustable lumbar support, Solve answers the need for a higher level of personalization. Solve task chairs feature a geometric ReActiv® back to create a contemporary look, while the 4-Way Stretch mesh back offers a softer, more relaxed feel. The synchronized seat and back move in harmony with the user to provide continuous comfort that can be customized. Helping anyone achieve optimal balance, proper alignment and lumbar support, Solve is an ideal solution for everywhere and everybody.

SEATING



FEATURES

- Synchronized seat and back create continuous comfort.
- Waterfall seat edge encourages leg circulation.
- Optional seat depth adjustment adapts to users of various heights.
- ReActiv® back design moves with your body to provide continuous support and airflow for lasting comfort.
- Available with three control types — synchro-tilt, synchro-tilt with seat slider and advanced synchro-tilt.
- Choose from four different arm options — armless, fixed, height- and width-adjustable or all-adjustable arms.
- Optional lumbar support delivers long-lasting comfort.
- Available with bell glides, hard casters or all-surface casters.
- Upholstered ReActiv® back offers all the benefits of the ReActiv® back with a fabric cover for additional comfort.
- Back upholstery available in one of six attractive fabrics.
- Choose from 3 frame options: Black, Titanium and White.
- Available in seven mesh back and seven lumbar colors and thousands of fabrics.
- Warranted for users up to 300 lbs.

MODEL OPTIONS

HSLVTMM



Mid-Back Task (4-Way Stretch Back)

Pneumatic, Swivel, Synchro-tilt, Tilt Tension, Tilt Lock

HSLVSMM



Stool (4-Way Stretch Back)

Pneumatic, Swivel, Synchro-tilt, Tilt Tension, Tilt Lock

HSLVTMMS



Mid-Back Task (4-Way Stretch Back) with Designer White frame

Pneumatic, Swivel, Synchro-tilt, Tilt Tension, Tilt Lock

HSLVSMMS



Stool (4-Way Stretch Back) with Designer White frame

Pneumatic, Swivel, Synchro-tilt, Tilt Tension, Tilt Lock

HSLVTMR



Mid-Back Task (ReActiv[®] Back)

Pneumatic, Swivel, Synchro-tilt, Tilt Tension, Tilt Lock

HSLVSMR



Stool (ReActiv[®] Back)

Pneumatic, Swivel, Synchro-tilt, Tilt Tension, Tilt Lock

HSLVTMRS



Mid-Back Task (ReActiv[®] Back) with Designer White frame

Pneumatic, Swivel, Synchro-tilt, Tilt Tension, Tilt Lock

HSLVSMRS



Stool (ReActiv[®] Back) with Designer White frame

Pneumatic, Swivel, Synchro-tilt, Tilt Tension, Tilt Lock

HSLVTMU



Mid-Back Task (Upholstered Back)

Pneumatic, Swivel, Synchro-tilt, Tilt Tension, Tilt Lock

HSLVSMU



Stool (Upholstered Back)

Pneumatic, Swivel, Synchro-tilt, Tilt Tension, Tilt Lock

HSLVTMUS



Mid-Back Task (Upholstered Back) with Designer White frame

Pneumatic, Swivel, Synchro-tilt, Tilt Tension, Tilt Lock

HSLVSMUS





Stool (Upholstered Back) with Designer White frame



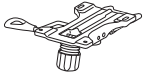
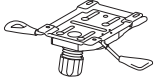
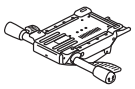

Pneumatic, Swivel, Synchro-tilt, Tilt Tension, Tilt Lock



SOLVE® Options

| MECHANISM | CODE | DESCRIPTION | PRICE |
|--|-----------|--|--------------|
|  | Y0 | Synchro-Tilt A, E, J, K, L | +\$0 |
|  | Y1 | Synchro-Tilt w/Seat Slider A, D, E, J, K, L | +\$20 |
|  | Y2 | Advanced Synchro-Tilt A, D, E, J, L, A-D | +\$65 |

**Y2 control not available on stool models*

| ARM STYLE | CODE | DESCRIPTION | PRICE |
|--|------------|--|---------------|
| | N | Armless | +\$0 |
|  | F | Fixed Arms | +\$65 |
| | | <i>*Not available on Designer White models</i> | |
|  | A | Height and Width Adjustable Arms | +\$85 |
|  | V | All-Adjustable Arms (includes Pivot) | +\$130 |
| | | <i>*Not available on Designer White models</i> | |
| | ADW | Height and Width Adjustable Arms | +\$85 |

| CASTERS/ GLIDE | CODE | DESCRIPTION | PRICE |
|--|----------|--------------------------|--------------|
|  | H | Black Hard Caster | +\$0 |
|  | S | Black All-Surface Caster | +\$40 |
|  | R | Roll Control Caster | +\$50 |
|  | G | Bell Glide | +\$25 |

| BACK STYLE | CODE | DESCRIPTION | PRICE |
|---|---------------|---|-------------|
| | | <i>4-Way Stretch mesh back options:</i> | |
|  | IM | Black | +\$0 |
| | IB | Breeze | +\$0 |
| | IK | Brownstone | +\$0 |
| | IC | Charcoal | +\$0 |
| | IF | Fog | +\$0 |
| | IR | Regatta | +\$0 |
| | IT | Titanium | +\$0 |
| | | <i>ReActiv® back options:</i> | |
|  | OS | Charcoal | +\$0 |
| | DW | Designer White | +\$0 |
| | TI | Titanium | +\$0 |
| | | <i>Fabric options:</i> | |
|  | COMF46 | Bittersweet | +\$0 |
| | COMF10 | Ink | +\$0 |
| | COMF82 | Meadow | +\$0 |
| | COMF90 | Midnight | +\$0 |
| | COMF22 | Putty | +\$0 |
| | COMF19 | Sterling | +\$0 |

| LUMBAR | CODE | DESCRIPTION | PRICE |
|---|-----------|-------------------------------------|--------------|
| | NL | No Lumbar | +\$0 |
|  | BL | Black Adjustable Lumbar | +\$30 |
| | BY | Bullseye Adjustable Lumbar | +\$30 |
| | DW | Designer White Adjustable Lumbar | +\$30 |
| | KT | Krypton Adjustable Lumbar | +\$30 |
| | MR | Ember Adjustable Lumbar | +\$30 |
| | RE | Regatta Adjustable Lumbar | +\$30 |
| | TL | Titanium Adjustable Lumbar | +\$30 |

| BASE | CODE | DESCRIPTION | PRICE |
|---|-----------|---------------|-------------|
|  | SB | Standard Base | +\$0 |

| FRAME | CODE | DESCRIPTION | PRICE |
|-------|-----------|----------------|--------------|
| | T | Black | +\$0 |
| | TI | Titanium | +\$35 |
| | DW | Designer White | +\$35 |

HON BRANDED FABRICS

| GRADE 1 | GRADE 2 | GRADE 3 | GRADE L |
|--------------|-----------------|-----------|-------------------------------|
| Apex | Appoint Seating | In Season | Denver Leather (Seat Only) |
| Attire | Blume | Moxie | |
| Centurion | Clyde | Parker | |
| Compass | Dotty | Purl | |
| Compass Foam | Rush | Quill | |
| Contourett | Seed | | |
| Dapper | Spin Seating | | |
| Ensemble | Whisper Vinyl | | |
| Hamilton | | | |
| Inertia | | | |
| Optic | | | |
| Pebble | | | |

For a complete list of fabrics, including partnership fabrics, go to hon.com/fabricsandfinishes.

Reference Fabric Color Combinations on pages 18-22 for color codes and legend on page 19 for lead times.

DIMENSIONS

NOTE: When selecting the .TI Titanium or .DW Designer White frame option, the chair's back frame, arms, and base will match. 4-Way Stretch, ReActiv[®], and/or lumbar color must be selected separately.

| MODEL | | HSLVTMM /HSLVTMMS | HSLVSMM /HSLVSMS | HSLVTMR /HSLVTMRS | HSLVSMR /HSLVSMRS | HSLVTMU /HSLVTMUS | HSLVSMU /HSLVSMUS |
|-------------------------|---------|----------------------|---------------------|----------------------|----------------------|----------------------|----------------------|
| Overall Width Armless | | 29½" | 29½" | 29½" | 29½" | 29½" | 29½" |
| Overall Width with Arms | (A) | 29½" | 29½" | 29½" | 29½" | 29½" | 29½" |
| Overall Depth | | 29½" | 29½" | 29½" | 29½" | 29½" | 29½" |
| Overall Height - Max | (Y0/Y1) | 41¾" | 52¾" | 41¾" | 52¾" | 41¾" | 52¾" |
| | (Y2) | 42½" | — | 42½" | — | 42½" | — |
| Seat Width | | 19" | 19" | 19" | 19" | 19" | 19" |
| Seat Depth (Cushion) | | 19¼" | 19¼" | 19¼" | 19¼" | 19¼" | 19¼" |
| Usable Seat Depth | (Y0) | 17⅝" | 17⅝" | 17⅝" | 17⅝" | 17⅝" | 17⅝" |
| | (Y1) | 16¼"-18½" | 16¼"-18½" | 16¼"-18½" | 16¼"-18½" | 16¼"-18½" | 16¼"-18½" |
| | (Y2) | 16¼"-19¼" | — | 16¼"-19¼" | — | 16¼"-19¼" | — |
| Seat Height | (Y0/Y1) | 16¾"-21¾" | 22¾"-32¾" | 16¾"-21¾" | 22¾"-32¾" | 16¾"-21¾" | 22¾"-32¾" |
| | (Y2) | 17½"-22½" | — | 17½"-22½" | — | 17½"-22½" | — |
| Back Width | | 18¼" | 18¼" | 18¼" | 18¼" | 18¼" | 18¼" |
| Back Height | | 21½" | 21½" | 21½" | 21½" | 21½" | 21½" |
| Ship Weight Armless | (Y0) | 40 Ⓢ | 45 Ⓢ | 41 Ⓢ | 46 Ⓢ | 41 Ⓢ | 46 Ⓢ |
| | (Y1) | 42 Ⓢ | 47 Ⓢ | 43 Ⓢ | 48 Ⓢ | 43 Ⓢ | 48 Ⓢ |
| | (Y2) | 45 Ⓢ | — | 46 Ⓢ | — | 46 Ⓢ | — |
| Ship Weight with Arms | (Y0) | 44 Ⓢ | 49 Ⓢ | 45 Ⓢ | 50 Ⓢ | 45 Ⓢ | 50 Ⓢ |
| | (Y1) | 46 Ⓢ | 51 Ⓢ | 47 Ⓢ | 52 Ⓢ | 47 Ⓢ | 52 Ⓢ |
| | (Y2) | 49 Ⓢ | — | 50 Ⓢ | — | 50 Ⓢ | — |
| Width Between Arms | | 17½"-20" | 17½"-20" | 17½"-20" | 17½"-20" | 17½"-20" | 17½"-20" |
| COM | | 1.0 | 1.0 | 1.0 | 1.0 | 1.0 | 1.0 |
| Weight Capacity | | 300 lbs | 300 lbs | 300 lbs | 300 lbs | 300 lbs | 300 lbs |



HSLVTMM

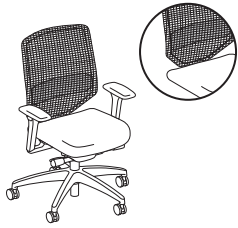

MID-BACK TASK

4-Way Stretch Back
Pneumatic
Swivel
Synchro-tilt
Tilt Tension
Tilt Lock

DIMENSIONS

Seat Depth: 19¼ Arm Width: 17½-20
Seat Width: 19 Cube: 10.8
Back Width: 18¼ Weight Rating: 300 lbs.
Back Height: 21½

FABRIC PRICE CODES

| | | | |
|---|-------|----|-------|
| 1 | \$504 | 8 | \$573 |
| 2 | \$516 | 9 | \$582 |
| 3 | \$528 | 10 | \$591 |
| 4 | \$537 | 11 | \$600 |
| 5 | \$546 | 12 | \$609 |
| 6 | \$555 | L | \$604 |
| 7 | \$564 | | |

NOTES: Please reference pages 448-449 for additional specifications and mechanism information.

HSLVTMMS

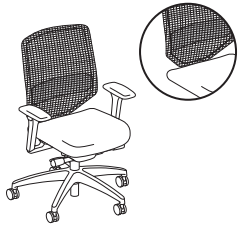

MID-BACK TASK IN DESIGNER WHITE

4-Way Stretch Back
Pneumatic
Swivel
Synchro-tilt
Tilt Tension
Tilt Lock

DIMENSIONS

Seat Depth: 19¼ Arm Width: 17½-20
Seat Width: 19 Cube: 10.8
Back Width: 18¼ Weight Rating: 300 lbs.
Back Height: 21½

FABRIC PRICE CODES

| | | | |
|---|-------|----|-------|
| 1 | \$504 | 8 | \$573 |
| 2 | \$516 | 9 | \$582 |
| 3 | \$528 | 10 | \$591 |
| 4 | \$537 | 11 | \$600 |
| 5 | \$546 | 12 | \$609 |
| 6 | \$555 | L | \$604 |
| 7 | \$564 | | |

OPEN MARKET

NOTES: Please reference pages 448-449 for additional specifications and mechanism information.

HON Recommendation: HSLVTMM.Y1.A.S.IM.CU__BL.SB.T - List Price \$679

HOW TO SPECIFY

| Select Model Number | Select Control Type | Select Arm Type | Select Caster/Glide | Select Mesh Back | Select Fabric | Select Lumbar | Select Base | Select Frame |
|--|---|---|---|-----------------------|----------------|--|-------------------------|---|
| Y0 Synchro-Tilt Y1 Synchro-Tilt w/ Seat Slider (+ \$20) Y2 Advanced Synchro-Tilt (+ \$65) | N Armless F Fixed Arms (+ \$65) A Height and Width Adjustable Arms (+ \$85) V All-Adjustable Arms (includes pivot) (+ \$130) | H Black Hard Caster S Black All-Surface Caster (+ \$40) G Bell Glide (+ \$25) R Black Roll Control Caster (+ \$50) | IM Black IB Breeze IK Brownstone IC Charcoal IF Fog IR Regatta IT Titanium | 4-Way Stretch options | See page 449 | NL No Lumbar BL Black Adjustable Lumbar (+ \$30) BY Bullseye Adjustable Lumbar (+ \$30) DW Designer White Adjustable Lumbar (+ \$30) KT Krypton Adjustable Lumbar (+ \$30) MR Ember Adjustable Lumbar (+ \$30) RE Regatta Adjustable Lumbar (+ \$30) TL Titanium Adjustable Lumbar (+ \$30) | SB Standard Base | HSLVTMM Options T Black TI Titanium (+ \$35) HSLVTMMS Options DW Designer White (+ \$35) <i>Available for model HSLVTMMS only</i> |
| H S L V T M M | Y 1 | A | S | I M | C U 1 0 | B L | S B | T |

SEATING



Icon Legend on page 17

HSLVSMM

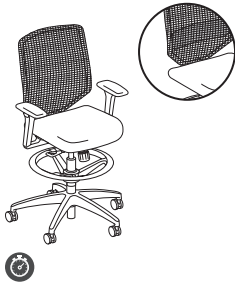

STOOL

- 4-Way Stretch Back**
- Pneumatic
- Swivel
- Synchro-tilt
- Tilt Tension
- Tilt Lock

DIMENSIONS

- Seat Depth: 19¼
- Seat Width: 19
- Back Width: 18¼
- Back Height: 21½
- Arm Width: 17½-20
- Cube: 10.8
- Weight Rating: 300 lbs.

FABRIC PRICE CODES

| | | | |
|---|-------|----|-------|
| 1 | \$564 | 8 | \$633 |
| 2 | \$576 | 9 | \$642 |
| 3 | \$588 | 10 | \$651 |
| 4 | \$597 | 11 | \$660 |
| 5 | \$606 | 12 | \$669 |
| 6 | \$615 | L | \$664 |
| 7 | \$624 | | |

NOTES: Please reference pages 448-449 for additional specifications and mechanism information.

HSLVSMMS



STOOL IN DESIGNER WHITE

- 4-Way Stretch Back**
- Pneumatic
- Swivel
- Synchro-tilt
- Tilt Tension
- Tilt Lock

DIMENSIONS

- Seat Depth: 19¼
- Seat Width: 19
- Back Width: 18¼
- Back Height: 21½
- Arm Width: 17½-20
- Cube: 10.8
- Weight Rating: 300 lbs.

FABRIC PRICE CODES

| | | | |
|---|-------|----|-------|
| 1 | \$564 | 8 | \$633 |
| 2 | \$576 | 9 | \$642 |
| 3 | \$588 | 10 | \$651 |
| 4 | \$597 | 11 | \$660 |
| 5 | \$606 | 12 | \$669 |
| 6 | \$615 | L | \$664 |
| 7 | \$624 | | |

OPEN MARKET

NOTES: Please reference pages 448-449 for additional specifications and mechanism information.

HON Recommendation: HSLVSMM.Y1.A.S.IM.CU__BL.SB.T - List Price \$739

HOW TO SPECIFY

| Select Model Number | Select Control Type | Select Arm Type | Select Caster/Glide | Select Mesh Back | Select Fabric | Select Lumbar | Select Base | Select Frame |
|---------------------|--------------------------------------|---|---|---|---------------|--|------------------|---|
| Y1 | Synchro-Tilt w/ Seat Slider (+ \$20) | HSLVSMM Options N Armless F Fixed Arms (+ \$65) A Height and Width Adjustable Arms (+ \$85) V All-Adjustable Arms (includes pivot) (+ \$130) HSLVSMMS Options ADW Height and Width Adjustable Arms (+ \$85) <i>Available for model HSLVSMMS only</i> | H Black Hard Caster S Black All-Surface Caster (+ \$40) G Bell Glide (+ \$25) R Black Roll Control Caster (+ \$50) | 4-Way Stretch options IM Black IB Breeze IK Brownstone IC Charcoal IF Fog IR Regatta IT Titanium | See page 449 | NL No Lumbar BL Black Adjustable Lumbar (+ \$30) BY Bullseye Adjustable Lumbar (+ \$30) DW Designer White Adjustable Lumbar (+ \$30) KT Krypton Adjustable Lumbar (+ \$30) MR Ember Adjustable Lumbar (+ \$30) RE Regatta Adjustable Lumbar (+ \$30) TL Titanium Adjustable Lumbar (+ \$30) | SB Standard Base | T Black TI Titanium (+ \$35 for HSLVSMM; + \$55 for HSLVSMMS) DWX Designer White (+ \$55; available on HSLVSMMS only) |
| H S L V S M M . | Y 1 . | A . | S . | I M . | C U I O . | B L . | S B . | T |

SEATING

HSLVTMR

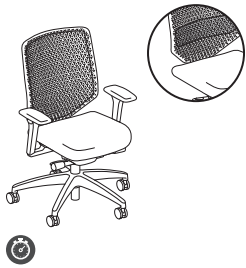

MID-BACK TASK

ReActiv® Back
Pneumatic
Swivel
Synchro-tilt
Tilt Tension
Tilt Lock

DIMENSIONS

Seat Depth: 19¼ Arm Width: 17½-20
Seat Width: 19 Cube: 10.8
Back Width: 18¼ Weight Rating: 300 lbs.
Back Height: 21½

FABRIC PRICE CODES

| | | | |
|---|-------|----|-------|
| 1 | \$539 | 8 | \$608 |
| 2 | \$551 | 9 | \$617 |
| 3 | \$563 | 10 | \$626 |
| 4 | \$572 | 11 | \$635 |
| 5 | \$581 | 12 | \$644 |
| 6 | \$590 | L | \$639 |
| 7 | \$599 | | |

NOTES: Please reference pages 448-449 for additional specifications and mechanism information.

HSLVTMRS

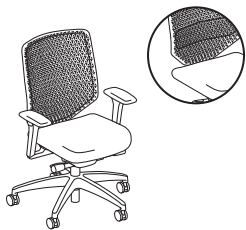

MID-BACK TASK IN DESIGNER WHITE

ReActiv® Back
Pneumatic
Swivel
Synchro-tilt
Tilt Tension
Tilt Lock

DIMENSIONS

Seat Depth: 19¼ Arm Width: 17½-20
Seat Width: 19 Cube: 10.8
Back Width: 18¼ Weight Rating: 300 lbs.
Back Height: 21½

FABRIC PRICE CODES

| | | | |
|---|-------|----|-------|
| 1 | \$539 | 8 | \$608 |
| 2 | \$551 | 9 | \$617 |
| 3 | \$563 | 10 | \$626 |
| 4 | \$572 | 11 | \$635 |
| 5 | \$581 | 12 | \$644 |
| 6 | \$590 | L | \$639 |
| 7 | \$599 | | |

OPEN MARKET

NOTES: Please reference pages 448-449 for additional specifications and mechanism information.

HON Recommendation: HSLVTMR.Y1.A.H.OS.CU__NL.SB.T - List Price \$644

HOW TO SPECIFY

| Select Model Number | Select Control Type | Select Arm Type | Select Caster/Glide | Select Back Color | Select Fabric | Select Lumbar | Select Base | Select Frame |
|--|---|---|--|-------------------|--|-------------------------|---|--------------|
| Y0 Synchro-Tilt Y1 Synchro-Tilt w/ Seat Slider (+ \$20) Y2 Advanced Synchro-Tilt (+ \$65) | N Armless F Fixed Arms (+ \$65) A Height and Width Adjustable Arms (+ \$85) V All-Adjustable Arms (includes pivot) (+ \$130) | H Black Hard Caster S Black All-Surface Caster (+ \$40) G Bell Glide (+ \$25) R Black Roll Control Caster (+ \$50) | OS Charcoal TI Titanium DW Designer White | See page 449 | NL No Lumbar BL Black Adjustable Lumbar (+ \$30) BY Bullseye Adjustable Lumbar (+ \$30) DW Designer White Adjustable Lumbar (+ \$30) KT Krypton Adjustable Lumbar (+ \$30) MR Ember Adjustable Lumbar (+ \$30) RE Regatta Adjustable Lumbar (+ \$30) TL Titanium Adjustable Lumbar (+ \$30) | SB Standard Base | HSLVTMR Options T Black TI Titanium (+ \$35) HSLVTMRS Options DW Designer White (+ \$35) <i>Available for model HSLVTMRS only</i> | |
| H S L V T M R . | Y 1 . | A . | H . | O S . | C U 1 0 . | N L . | S B . | T |



Icon Legend on page 17

HSLVSMR



STOOL

ReActiv[®] Back
 Pneumatic
 Swivel
 Synchro-tilt
 Tilt Tension
 Tilt Lock

DIMENSIONS

Seat Depth: 19¼ Arm Width: 17½-20
 Seat Width: 19 Cube: 10.8
 Back Width: 18¼ Weight Rating: 300 lbs.
 Back Height: 21½

FABRIC PRICE CODES

| | | | |
|---|-------|----|-------|
| 1 | \$599 | 8 | \$668 |
| 2 | \$611 | 9 | \$677 |
| 3 | \$623 | 10 | \$686 |
| 4 | \$632 | 11 | \$695 |
| 5 | \$641 | 12 | \$704 |
| 6 | \$650 | L | \$699 |
| 7 | \$659 | | |

NOTES: Please reference pages 448-449 for additional specifications and mechanism information.

HSLVSMRS



STOOL IN DESIGNER WHITE

ReActiv[®] Back
 Pneumatic
 Swivel
 Synchro-tilt
 Tilt Tension
 Tilt Lock

DIMENSIONS

Seat Depth: 19¼ Arm Width: 17½-20
 Seat Width: 19 Cube: 10.8
 Back Width: 18¼ Weight Rating: 300 lbs.
 Back Height: 21½

FABRIC PRICE CODES

| | | | |
|---|-------|----|-------|
| 1 | \$599 | 8 | \$668 |
| 2 | \$611 | 9 | \$677 |
| 3 | \$623 | 10 | \$686 |
| 4 | \$632 | 11 | \$695 |
| 5 | \$641 | 12 | \$704 |
| 6 | \$650 | L | \$699 |
| 7 | \$659 | | |

OPEN MARKET

NOTES: Please reference pages 448-449 for additional specifications and mechanism information.

HON Recommendation: HSLVSMR.Y1.A.H.OS.CU__NL.SB.T - List Price \$704

HOW TO SPECIFY

| Select Model Number | Select Control Type | Select Arm Type | Select Caster/Glide | Select Back Color | Select Fabric | Select Lumbar | Select Base | Select Frame |
|---------------------|--|---|---|---|---------------|--|------------------|---|
| Y1 | YO Synchro-Tilt Y1 Synchro-Tilt w/ Seat Slider (+ \$20) | HSLVSMR Options N Armless F Fixed Arms (+ \$65) A Height and Width Adjustable Arms (+ \$85) V All-Adjustable Arms (includes pivot) (+ \$130) HSLVSMRS Options ADW Height and Width Adjustable Arms (+ \$85) <i>Available for model HSLVSMRS only</i> | H Black Hard Caster S Black All-Surface Caster (+ \$40) G Bell Glide (+ \$25) R Black Roll Control Caster (+ \$50) | OS Charcoal TI Titanium DW Designer White | See page 449 | NL No Lumbar BL Black Adjustable Lumbar (+ \$30) BY Bullseye Adjustable Lumbar (+ \$30) DW Designer White Adjustable Lumbar (+ \$30) KT Krypton Adjustable Lumbar (+ \$30) MR Ember Adjustable Lumbar (+ \$30) RE Regatta Adjustable Lumbar (+ \$30) TL Titanium Adjustable Lumbar (+ \$30) | SB Standard Base | T Black TI Titanium (+ \$35 for HSLVSMR; + \$55 for HSLVSMRS) DWX Designer White (+ \$55; available on HSLVSMRS only) |
| H S L V S M R | Y 1 | A | H | O S | C U 1 0 | N L | S B | T |

SEATING



HSLVTMU

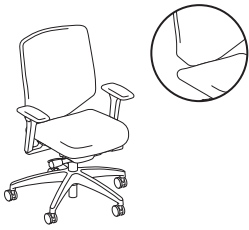

MID-BACK TASK

Upholstered Back
Pneumatic
Swivel
Synchro-tilt
Tilt Tension
Tilt Lock

DIMENSIONS

Seat Depth: 19¼ Arm Width: 17½-20
Seat Width: 19 Cube: 10.8
Back Width: 18¼ Weight Rating: 300 lbs.
Back Height: 21½

FABRIC PRICE CODES

| | | | |
|---|-------|----|-------|
| 1 | \$554 | 8 | \$623 |
| 2 | \$566 | 9 | \$632 |
| 3 | \$578 | 10 | \$641 |
| 4 | \$587 | 11 | \$650 |
| 5 | \$596 | 12 | \$659 |
| 6 | \$605 | L | \$654 |
| 7 | \$614 | | |

NOTES: Please reference pages 448-449 for additional specifications and mechanism information.

HSLVTMUS

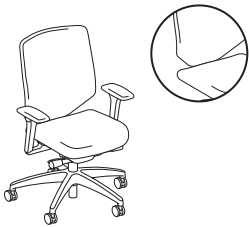

MID-BACK TASK IN DESIGNER WHITE

Upholstered Back
Pneumatic
Swivel
Synchro-tilt
Tilt Tension
Tilt Lock

DIMENSIONS

Seat Depth: 19¼ Arm Width: 17½-20
Seat Width: 19 Cube: 10.8
Back Width: 18¼ Weight Rating: 300 lbs.
Back Height: 21½

FABRIC PRICE CODES

| | | | |
|---|-------|----|-------|
| 1 | \$554 | 8 | \$623 |
| 2 | \$566 | 9 | \$632 |
| 3 | \$578 | 10 | \$641 |
| 4 | \$587 | 11 | \$650 |
| 5 | \$596 | 12 | \$659 |
| 6 | \$605 | L | \$654 |
| 7 | \$614 | | |

OPEN MARKET

NOTES: Please reference pages 448-449 for additional specifications and mechanism information.

HON Recommendation: HSLVTMU.Y1.A.H.OS.COMF10.COMP10.NL.SB.T - List Price \$659

HOW TO SPECIFY

| Select Model Number | Select Control Type | Select Arm Type | Select Caster/Glide | Select Back Color | Select Back Fabric | Select Seat Fabric | Select Lumbar | Select Base | Select Frame |
|---------------------|--|---|---|--|---|--------------------|--|-------------------------|---|
| | Y0 Synchro-Tilt Y1 Synchro-Tilt w/ Seat Slider (+ \$20) Y2 Advanced Synchro-Tilt (+ \$65) | HSLVTMU Options N Armless F Fixed Arms (+ \$65) A Height and Width Adjustable Arms (+ \$85) V All-Adjustable Arms (includes pivot) (+ \$130) | H Black Hard Caster S Black All-Surface Caster (+ \$40) G Bell Glide (+ \$25) R Black Roll Control Caster (+ \$50) | OS Charcoal TI Titanium DW Designer White | COMF46 Bittersweet COMF10 Ink COMF82 Meadow COMF90 Midnight COMF22 Putty COMF19 Sterling | See page 449 | NL No Lumbar BL Black Adjustable Lumbar (+ \$30) BY Bullseye Adjustable Lumbar (+ \$30) DW Designer White Adjustable Lumbar (+ \$30) KT Krypton Adjustable Lumbar (+ \$30) MR Ember Adjustable Lumbar (+ \$30) RE Regatta Adjustable Lumbar (+ \$30) TL Titanium Adjustable Lumbar (+ \$30) | SB Standard Base | HSLVTMU Options T Black TI Titanium (+ \$35) HSLVTMUS Options DW Designer White (+ \$35) Available for model HSLVTMUS only |
| HSLVTMU | Y1 | A | H | OS | COMF10 | COMP10 | NL | SB | T |

SEATING



Icon Legend on page 17

HSLVSMU

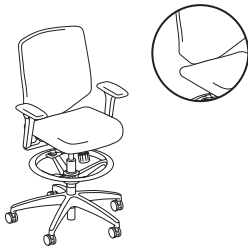

STOOL

Upholstered Back
 Pneumatic
 Swivel
 Synchro-tilt
 Tilt Tension
 Tilt Lock

DIMENSIONS

Seat Depth: 19¼ Arm Width: 17½-20
 Seat Width: 19 Cube: 10.8
 Back Width: 18¼ Weight Rating: 300 lbs.
 Back Height: 21½

FABRIC PRICE CODES

| | | | |
|---|-------|----|-------|
| 1 | \$615 | 8 | \$684 |
| 2 | \$627 | 9 | \$693 |
| 3 | \$639 | 10 | \$702 |
| 4 | \$648 | 11 | \$711 |
| 5 | \$657 | 12 | \$720 |
| 6 | \$666 | L | \$715 |
| 7 | \$675 | | |

NOTES: Please reference pages 448-449 for additional specifications and mechanism information.

HSLVSMUS

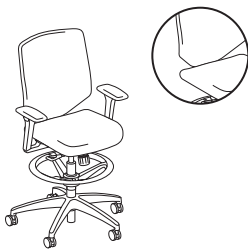

STOOL IN DESIGNER WHITE

Upholstered Back
 Pneumatic
 Swivel
 Synchro-tilt
 Tilt Tension
 Tilt Lock

DIMENSIONS

Seat Depth: 19¼ Arm Width: 17½-20
 Seat Width: 19 Cube: 10.8
 Back Width: 18¼ Weight Rating: 300 lbs.
 Back Height: 21½

FABRIC PRICE CODES

| | | | |
|---|-------|----|-------|
| 1 | \$615 | 8 | \$684 |
| 2 | \$627 | 9 | \$693 |
| 3 | \$639 | 10 | \$702 |
| 4 | \$648 | 11 | \$711 |
| 5 | \$657 | 12 | \$720 |
| 6 | \$666 | L | \$715 |
| 7 | \$675 | | |

OPEN MARKET

NOTES: Please reference pages 448-449 for additional specifications and mechanism information.

HON Recommendation: HSLVSMU.Y1.A.H.OS.COMF10.COMP10.NL.SB.T - List Price \$720

HOW TO SPECIFY

| Select Model Number | Select Control Type | Select Arm Type | Select Caster/Glide | Select Back Color | Select Back Fabric | Select Seat Fabric | Select Lumbar | Select Base | Select Frame |
|--|--|---|--|---|--------------------|--|-------------------------|--|--------------|
| Y0 Synchro-Tilt Y1 Synchro-Tilt w/ Seat Slider (+ \$20) | HSLVSMU Options N Armless F Fixed Arms (+ \$65) A Height and Width Adjustable Arms (+ \$85) V All-Adjustable Arms (includes pivot) (+ \$130) HSLVSMUS Options ADW Height and Width Adjustable Arms (+ \$85) <i>Available for model HSLVSMUS only</i> | H Black Hard Caster S Black All-Surface Caster (+ \$40) G Bell Glide (+ \$25) R Black Roll Control Caster (+ \$50) | OS Charcoal TI Titanium DW Designer White | COMF46 Bittersweet COMF10 Ink COMF82 Meadow COMF90 Midnight COMF22 Putty COMF19 Sterling | See page 449 | NL No Lumbar BL Black Adjustable Lumbar (+ \$30) BY Bullseye Adjustable Lumbar (+ \$30) DW Designer White Adjustable Lumbar (+ \$30) KT Krypton Adjustable Lumbar (+ \$30) MR Ember Adjustable Lumbar (+ \$30) RE Regatta Adjustable Lumbar (+ \$30) TL Titanium Adjustable Lumbar (+ \$30) | SB Standard Base | T Black TI Titanium (+ \$35 for HSLVSMU; + \$55 for HSLVSMUS) DWX Designer White (+ \$55; available on HSLVSMUS only) | |
| HSLVSMU | Y1 | A | H | OS | COMF10 | COMP10 | NL | SB | T |

SEATING

HSLVTMMKD

MID-BACK TASK

DIMENSIONS

FABRIC PRICE CODES



- 4-Way Stretch Back**
- Pneumatic
- Swivel
- Synchro-tilt
- Tilt Tension
- Tilt Lock

- Seat Depth: 19¼
- Seat Width: 19
- Back Width: 18¼
- Back Height: 21½
- Arm Width: 17½-20
- Cube: 5.6
- Weight Rating: 300 lbs.

- 1 \$464**
- 2 \$476**
- 3 \$488**

NOTES: Please reference pages 448-449 for additional specifications and mechanism information.

HSLVTMRKD

MID-BACK TASK

DIMENSIONS

FABRIC PRICE CODES

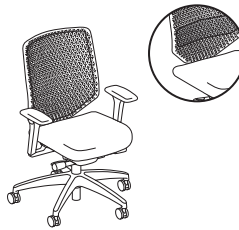

- ReActiv® Back**
- Pneumatic
- Swivel
- Synchro-tilt
- Tilt Tension
- Tilt Lock

- Seat Depth: 19¼
- Seat Width: 19
- Back Width: 18¼
- Back Height: 21½
- Arm Width: 17½-20
- Cube: 5.6
- Weight Rating: 300 lbs.

- 1 \$472**
- 2 \$484**
- 3 \$496**

NOTES: Please reference pages 448-449 for additional specifications and mechanism information.

HSLVTMUKD

MID-BACK TASK

DIMENSIONS

FABRIC PRICE CODES

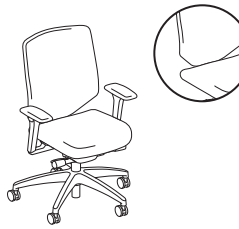

- Upholstered Back**
- Pneumatic
- Swivel
- Synchro-tilt
- Tilt Tension
- Tilt Lock

- Seat Depth: 19¼
- Seat Width: 19
- Back Width: 18¼
- Back Height: 21½
- Arm Width: 17½-20
- Cube: 5.6
- Weight Rating: 300 lbs.

- 1 \$514**
- 2 \$526**
- 3 \$538**

NOTES: Please reference pages 448-449 for additional specifications and mechanism information.

HON Recommendation: HSLVTMMKD.Y1.A.H.IM.CU__BL.SB.T - List Price \$599

HOW TO SPECIFY

| Select Model Number | Select Control Type | Select Arm Type | Select Caster | Select Mesh Back | Select Back Color | Select Back Fabric | Select Seat Fabric | Select Lumbar | Select Base | Select Frame |
|---------------------|--|--|----------------------------|--|--|--|--------------------|---|-------------------------|----------------|
| | Y1 Synchro-Tilt w/ Seat Slider (+ \$20) | A Height and Width Adjustable Arms (+ \$85) | H Black Hard Caster | 4-Way Stretch options IM Black <i>Specify for model HSLVTMMKD only</i> | OS Charcoal TI Titanium <i>Specify for models HSLVTMRKD and HSLVTMUKD only</i> | COMF46 Bittersweet COMF10 Ink COMF82 Meadow COMF90 Midnight COMF22 Putty COMF19 Sterling <i>Specify for model HSLVTMUKD only</i> | See page 449 | NL No Lumbar BL Black Adjustable Lumbar (+ \$30) | SB Standard Base | T Black |
| HSLVTMMKD | Y1 | A | H | IM | | | CU10 | BL | SB | T |
| HSLVTMRKD | Y1 | A | H | | OS | | CU10 | BL | SB | T |
| HSLVTMUKD | Y1 | A | H | | OS | COMF46 | CU10 | BL | SB | T |



HSLVLMBR

LUMBAR PACK

DIMENSIONS

LIST PRICE

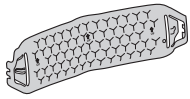

Ship Weight: 1
Cube: 0.2

\$36

HOW TO SPECIFY

Select Model Number

Select Color

- BY** Bullseye Adjustable Lumbar
- DW** Designer White Adjustable Lumbar
- KT** Krypton Adjustable Lumbar
- MR** Ember Adjustable Lumbar
- RE** Regatta Adjustable Lumbar
- T** Black
- TI** Titanium

H S L V L M B R .

T

HSLVFAP

FIXED ARM PACK

DIMENSIONS

LIST PRICE



Ship Weight: 6
Cube: 1.0

\$120

HSLV2DAP

ADJUSTABLE ARM PACK

DIMENSIONS

LIST PRICE



Height and Width

Adjustable Arms Width: 17½-20
Height from Seat: 7¼-11¼
Ship Weight: 6
Cube: 1.0

\$130

HSLV4DAP

ALL-ADJUSTABLE ARM PACK

DIMENSIONS

LIST PRICE



Including Pivot

Ship Weight: 6
Cube: 1.0

\$176

HSCASTER

SET OF 5 ALL-SURFACE CASTERS

DIMENSIONS

LIST PRICE

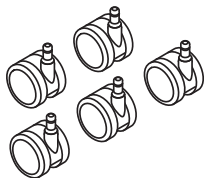

Size: 60mm
Ship Weight: 2
Cube: 0.1

\$59

ⓘ Available in Black finish only, no specification needed.

HOW TO SPECIFY

Select Model Number

Select Color

- T** Black
- TI** Titanium
- DW** Designer White (available on HSLV2DAP only)

H S L V 2 D A P .

T



Soothe Guest
Chairs and Tables.

SOOTHE®

Soothe offers the comfort and versatility to support a variety of healthcare and waiting environments. This family of patient and guest seats are constructed from durable materials and thoughtfully designed to be easily cleaned. The entire collection maximizes comfort along the patient's journey to recovery, enhances functionality for the caregiver, and creates the versatility required to deliver a higher level of care. Soothe simply helps create happier patients and better caregivers.



FEATURES

- Select Charcoal Urethane or solid hardwood arms in one of eight finishes.
- Wipeout space at the back of the seat allows for easy maintenance.
- Model HHCP1 has a responsive design back that moves with the patient for added comfort.
- Bench seating is available in two-seat or three-seat options.
- Choose Textured Charcoal or Textured Satin Chrome frame.
- Multi-fabric option offers endless color combinations.
- Chairs can be ganged together to create straight rows.
- Warranted for users up to 350 lbs. (Model HHCG50 bariatric chair warranted for 750 lbs.)

MODEL OPTIONS

HHCG11
HHCG11DF - Multi-Fabric



Guest Chair

HHCG21
HHCG21DF - Multi-Fabric

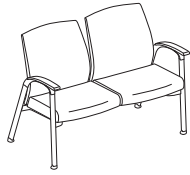

Two-Seat Chair

HHCG50
HHCG50DF - Multi-Fabric

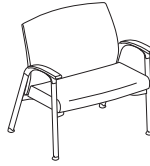

Bariatric Chair

HHCP1
HHCP1DF - Multi-Fabric



High-Back Patient Chair

HHCGB21

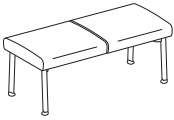

Two-Seat Bench

HHCGB31

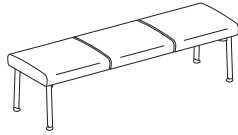

Three-Seat Bench

SOOTHE[®] Options

ARM CAP FINISH

| CODE | DESCRIPTION | PRICE |
|-------------|-------------------|---------------|
| S | Charcoal Urethane | +\$0 |
| H | Bourbon Cherry | +\$100 |
| F | Shaker Cherry | +\$100 |
| C | Harvest | +\$100 |
| D | Natural Maple | +\$100 |
| N | Mahogany | +\$100 |
| MOCH | Mocha | +\$100 |
| COGN | Cognac | +\$100 |
| PINC | Pinnacle | +\$100 |
| LKI1 | Kingswood Walnut | +\$100 |
| LFW1 | Florence Walnut | +\$100 |
| LSA1 | Sterling Ash | +\$100 |

FRAME

| CODE | DESCRIPTION | PRICE |
|-----------------|-------------------------|-------------|
| GRADE P1 | | |
| P6P | Textured Black Mica | +\$0 |
| PK7 | Textured Designer White | +\$0 |
| P7A | Textured Charcoal | +\$0 |
| P7J | Textured Brownstone | +\$0 |
| P7L | Textured Loft | +\$0 |
| P7M | Textured Muslin | +\$0 |
| P8V | Textured Titanium | +\$0 |
| GRADE P2 | | |
| PR8 | Textured Silver | +\$0 |

HON BRANDED FABRICS

GRADE 1

Apex
Attire
Centurion
Compass
Contourett
Dapper
Ensemble
Hamilton
Inertia
Optic
Pebble

GRADE 2

Appoint Seating
Blume
Clyde
Dotty
Rush
Seed
Spin Seating
Whisper Vinyl

GRADE 3

In Season
Moxie
Parker
Purl
Quill

For a complete list of fabrics, including partnership fabrics, go to hon.com/fabricsandfinishes.

Reference Fabric Color Combinations on pages 18-22 for color codes and legend on page 19 for lead times. For Fire Code and Moisture Barrier model availability and ordering method, refer to pages 216. For additional HON to Supply COM fabric grade pricing, go to honready.hon.com and click on the HON to Supply COM link.

MULTI-FABRIC COM YARDAGE

Due to fabric pattern nesting and potential reduction of fabric yield, some multi-fabric models may require more total yardage than standard models.

| | SEAT | BACK |
|----------|--------|--------|
| HHCG11DF | 1.4 yd | 1.5 yd |
| HHCG21DF | 1.7 yd | 2.3 yd |
| HHCG50DF | 1.4 yd | 2.3 yd |
| HHCP1DF | 1.4 yd | 1.9 yd |

SOOTHE[®]

Table Finish Options

AVAILABLE FINISHES

Soothe[®] Tables are available in 14 laminate colors. Each laminate has a specific selection of edges available.

| LAMINATE TOP COLORS | EDGE BAND COLORS |
|-------------------------|--|
| Designer White (LDW1) | Designer White (DW) |
| Charcoal (S) | Charcoal (S) |
| Silver Mesh (B9) | Loft (LOFT) |
| Bourbon Cherry (H) | Bourbon Cherry (H), Muslin (T), White (DW) |
| Mahogany (N) | Mahogany (N), Loft (LOFT) |
| Natural Maple (D) | Natural Maple (D), Muslin (T), White (DW), Loft (LOFT) |
| Shaker Cherry (F) | Shaker Cherry (F), Muslin (T), White (DW), Loft (LOFT) |
| Harvest (C) | Harvest (C), Muslin (T), White (DW), Loft (LOFT) |
| Cognac (COGN) | Cognac (COGN), Muslin (T), White (DW) |
| Mocha (MOCH) | Mocha (MOCH), Muslin (T), White (DW), Loft (LOFT) |
| Pinnacle (PINC) | Pinnacle (PINC), Muslin (T), White (DW), Loft (LOFT) |
| Florence Walnut (LFW1) | Florence Walnut (FW) |
| Kingswood Walnut (LK11) | Kingswood Walnut (KI) |
| Sterling Ash (LSA1) | Sterling Ash (SA) |



HHCG11

GUEST CHAIR



DIMENSIONS

| | | | |
|--------------|-----|-----------------------|----------|
| Depth: | 27 | Arm Width: | 20½ |
| Width: | 25½ | Seat to Floor Height: | 18⅝ |
| Height: | 35 | Usable Seat Depth: | 18 |
| Seat Depth: | 18 | Ship Weight: | 55 |
| Seat Width: | 21½ | Cube: | 14.9 |
| Back Width: | 21 | COM: | 2.0 |
| Back Height: | 20½ | Weight Rating: | 350 lbs. |

FABRIC PRICE CODES

| | | | |
|---|--------|----|--------|
| 1 | \$1139 | 8 | \$1415 |
| 2 | \$1139 | 9 | \$1451 |
| 3 | \$1235 | 10 | \$1487 |
| 4 | \$1271 | 11 | \$1523 |
| 5 | \$1307 | 12 | \$1559 |
| 6 | \$1343 | L | — |
| 7 | \$1379 | | |

HHCG21

TWO-SEAT CHAIR

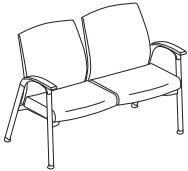

Outside Arms

DIMENSIONS

| | | | |
|-------------------|-----|-----------------------|----------|
| Depth: | 27 | Arm Width: | 42¾ |
| Width: | 48 | Seat to Floor Height: | 18⅝ |
| Height: | 35 | Usable Seat Depth: | 18 |
| Each Seat Depth: | 18 | Ship Weight: | 109 |
| Each Seat Width: | 21½ | Cube: | 33.8 |
| Each Back Width: | 21 | COM: | 3.4 |
| Each Back Height: | 20¼ | Weight Rating: | 350 lbs. |

FABRIC PRICE CODES

| | | | |
|---|--------|----|--------|
| 1 | \$1882 | 8 | \$2365 |
| 2 | \$1966 | 9 | \$2428 |
| 3 | \$2050 | 10 | \$2491 |
| 4 | \$2113 | 11 | \$2554 |
| 5 | \$2176 | 12 | \$2617 |
| 6 | \$2239 | L | — |
| 7 | \$2302 | | |

HHCG50

BARIATRIC CHAIR



DIMENSIONS

| | | | |
|--------------|-----|-----------------------|----------|
| Depth: | 26 | Arm Width: | 29½ |
| Width: | 34½ | Seat to Floor Height: | 18⅝ |
| Height: | 35 | Usable Seat Depth: | 18 |
| Seat Depth: | 18 | Ship Weight: | 80 |
| Seat Width: | 30½ | Cube: | 25.1 |
| Back Width: | 30 | COM: | 3.0 |
| Back Height: | 20½ | Weight Rating: | 750 lbs. |

FABRIC PRICE CODES

| | | | |
|---|--------|----|--------|
| 1 | \$1429 | 8 | \$1912 |
| 2 | \$1513 | 9 | \$1975 |
| 3 | \$1597 | 10 | \$2038 |
| 4 | \$1660 | 11 | \$2101 |
| 5 | \$1723 | 12 | \$2164 |
| 6 | \$1786 | L | — |
| 7 | \$1849 | | |

! HHCG50 is a Single Seat Bariatric chair warranted to 750 lbs.

HHCP1

HIGH-BACK PATIENT CHAIR

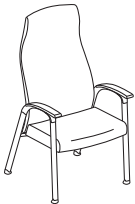

DIMENSIONS

| | | | |
|--------------|-----|-----------------------|----------|
| Depth: | 27 | Arm Width: | 20½ |
| Width: | 25½ | Seat to Floor Height: | 18⅝ |
| Height: | 46½ | Usable Seat Depth: | 18 |
| Seat Depth: | 18 | Ship Weight: | 61 |
| Seat Width: | 21½ | Cube: | 19.1 |
| Back Width: | 21 | COM: | 2.4 |
| Back Height: | 32 | Weight Rating: | 350 lbs. |

FABRIC PRICE CODES

| | | | |
|---|--------|----|--------|
| 1 | \$1269 | 8 | \$1752 |
| 2 | \$1353 | 9 | \$1815 |
| 3 | \$1437 | 10 | \$1878 |
| 4 | \$1500 | 11 | \$1941 |
| 5 | \$1563 | 12 | \$2004 |
| 6 | \$1626 | L | — |
| 7 | \$1689 | | |

! Only available in Moxie and In Season under HON's Standard Fabric. Healthcare Grade Partnership Fabrics are available. For a complete list, please visit the Fabrics and Finishes page at HON.com.

OPEN MARKET

HOW TO SPECIFY

| | | | |
|--|--|--|--|
| Select Model Number HHCG11 | Select Arm Cap Finish S Charcoal Urethane H Bourbon Cherry (+ \$100) F Shaker Cherry (+ \$100) C Harvest (+ \$100) D Natural Maple (+ \$100) N Mahogany (+ \$100) MOCH Mocha (+ \$100) COGN Cognac (+ \$100) PINC Pinnacle (+ \$100) LK11 Kingswood Walnut (+ \$100) LFW1 Florence Walnut (+ \$100) LSA1 Sterling Ash (+ \$100) | Select Fabric See page 460 A190 | Select Frame See page 460 PR8 |
|--|--|--|--|



SOOTHE® Multi-Fabric

HHCG11DF



GUEST CHAIR

Multi-Fabric

DIMENSIONS

| | | | |
|--------------|-----|-----------------------|--------------|
| Depth: | 27 | Arm Width: | 20½ |
| Width: | 25½ | Seat to Floor Height: | 18⅞ |
| Height: | 35 | Usable Seat Depth: | 18 |
| Seat Depth: | 18 | Ship Weight: | 55 |
| Seat Width: | 21½ | Cube: | 14.9 |
| Back Width: | 21 | COM: | See page 460 |
| Back Height: | 20½ | Weight Rating: | 350 lbs. |

FABRIC PRICE CODES

| | | |
|--------------------------------|---------------|--------------|
| 1 | \$1228 | |
| <i>Add to Base Price Above</i> | | |
| | Back | Seat |
| 2 | \$24 | \$24 |
| 3 | \$48 | \$48 |
| 4 | \$66 | \$66 |
| 5 | \$84 | \$84 |
| 6 | \$102 | \$102 |
| 7 | \$120 | \$120 |
| 8 | \$138 | \$138 |
| 9 | \$156 | \$156 |
| 10 | \$174 | \$174 |
| 11 | \$192 | \$192 |
| 12 | \$210 | \$210 |

NOTES: For multi-fabric models, start with the base price, then add the additional amount for the back and seat from the corresponding matrix to determine final price. Choose any combination of fabric grades for back and seat. See examples below:
HHCG11DF base price (\$1228) + Grade 2 back fabric (add \$24) + Grade 4 seat fabric (add \$66) = Total \$1318 List

HHCG21DF

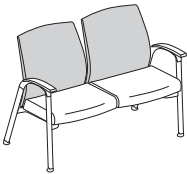

TWO-SEAT CHAIR

Multi-Fabric
Outside Arms

DIMENSIONS

| | | | |
|-------------------|-----|-----------------------|--------------|
| Depth: | 27 | Arm Width: | 42¾ |
| Width: | 48 | Seat to Floor Height: | 18⅞ |
| Height: | 35 | Usable Seat Depth: | 18 |
| Each Seat Depth: | 18 | Ship Weight: | 109 |
| Each Seat Width: | 21½ | Cube: | 33.8 |
| Each Back Width: | 21 | COM: | See page 460 |
| Each Back Height: | 20¼ | Weight Rating: | 350 lbs. |

FABRIC PRICE CODES

| | | |
|--------------------------------|---------------|--------------|
| 1 | \$1971 | |
| <i>Add to Base Price Above</i> | | |
| | Back | Seat |
| 2 | \$48 | \$36 |
| 3 | \$96 | \$72 |
| 4 | \$132 | \$99 |
| 5 | \$168 | \$126 |
| 6 | \$203 | \$154 |
| 7 | \$239 | \$181 |
| 8 | \$275 | \$208 |
| 9 | \$311 | \$235 |
| 10 | \$347 | \$262 |
| 11 | \$383 | \$289 |
| 12 | \$419 | \$316 |

NOTES: For multi-fabric models, start with the base price, then add the additional amount for the back and seat from the corresponding matrix to determine final price. Choose any combination of fabric grades for back and seat. See examples below:
HHCG21DF base price (\$1971) + Grade 2 back fabric (add \$48) + Grade 4 seat fabric (add \$99) = Total \$2118 List

HOW TO SPECIFY

| | | | | |
|--|--|---|---|--|
| Select Model Number HHCG11DF | Select Arm Cap Finish S Charcoal Urethane H Bourbon Cherry (+ \$100) F Shaker Cherry (+ \$100) C Harvest (+ \$100) D Natural Maple (+ \$100) N Mahogany (+ \$100) MOCH Mocha (+ \$100) COGN Cognac (+ \$100) PINC Pinnacle (+ \$100) LK11 Kingswood Walnut (+ \$100) LFW1 Florence Walnut (+ \$100) LSA1 Sterling Ash (+ \$100) | Select Back Fabric See page 460 AI90 | Select Seat Fabric See page 460 RS14 | Select Frame See page 460 PR8 |
|--|--|---|---|--|

SOOTHE® Multi-Fabric

GSA SIN AS NOTED



Icon Legend on page 17

HHCG50DF

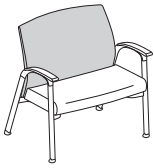

SIN 33721

BARIATRIC CHAIR

Multi-Fabric

DIMENSIONS

| | | | |
|--------------|-----|-----------------------|--------------|
| Depth: | 26 | Arm Width: | 29½ |
| Width: | 34½ | Seat to Floor Height: | 18⅝ |
| Height: | 35 | Usable Seat Depth: | 18 |
| Seat Depth: | 18 | Ship Weight: | 80 |
| Seat Width: | 30½ | Cube: | 25.1 |
| Back Width: | 30 | COM: | See page 460 |
| Back Height: | 20½ | Weight Rating: | 750 lbs. |

FABRIC PRICE CODES

| | | |
|--------------------------------|---------------|--------------|
| 1 | \$1518 | |
| <i>Add to Base Price Above</i> | | |
| | Back | Seat |
| 2 | \$48 | \$36 |
| 3 | \$96 | \$72 |
| 4 | \$132 | \$99 |
| 5 | \$168 | \$126 |
| 6 | \$203 | \$154 |
| 7 | \$239 | \$181 |
| 8 | \$275 | \$208 |
| 9 | \$311 | \$235 |
| 10 | \$347 | \$262 |
| 11 | \$383 | \$289 |
| 12 | \$419 | \$316 |

NOTES: For multi-fabric models, start with the base price, then add the additional amount for the back and seat from the corresponding matrix to determine final price. Choose any combination of fabric grades for back and seat. See examples below:

HHCG50DF base price (\$1518) + Grade 2 back fabric (add \$48) + Grade 4 seat fabric (add \$99) = Total \$1665 List

❗ HHCG50DF is a Single Seat Bariatric chair warranted to 750 lbs.

HHCP1DF

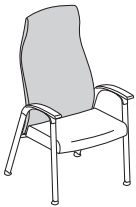

OPEN MARKET

HIGH-BACK PATIENT CHAIR

Multi-Fabric

DIMENSIONS

| | | | |
|--------------|-----|-----------------------|--------------|
| Depth: | 27 | Arm Width: | 20½ |
| Width: | 25½ | Seat to Floor Height: | 18⅝ |
| Height: | 46½ | Usable Seat Depth: | 18 |
| Seat Depth: | 18 | Ship Weight: | 61 |
| Seat Width: | 21½ | Cube: | 19.1 |
| Back Width: | 21 | COM: | See page 460 |
| Back Height: | 32 | Weight Rating: | 350 lbs. |

FABRIC PRICE CODES

| | | |
|--------------------------------|---------------|--------------|
| 1 | \$1357 | |
| <i>Add to Base Price Above</i> | | |
| | Back | Seat |
| 2 | \$60 | \$24 |
| 3 | \$119 | \$49 |
| 4 | \$164 | \$67 |
| 5 | \$209 | \$85 |
| 6 | \$253 | \$104 |
| 7 | \$298 | \$122 |
| 8 | \$343 | \$140 |
| 9 | \$388 | \$158 |
| 10 | \$432 | \$177 |
| 11 | \$477 | \$195 |
| 12 | \$522 | \$213 |

NOTES: For multi-fabric models, start with the base price, then add the additional amount for the back and seat from the corresponding matrix to determine final price. Choose any combination of fabric grades for back and seat. See examples below:

HHCP1DF base price (\$1357) + Grade 2 back fabric (add \$60) + Grade 4 seat fabric (add \$67) = Total \$1484 List

❗ Only available in Moxie and In Season under HON's Standard Fabric. Healthcare Grade Partnership Fabrics are available. For a complete list, please visit the Fabrics and Finishes page at HON.com.

SEATING

HOW TO SPECIFY

| Select Model Number | Select Arm Cap Finish | Select Back Fabric | Select Seat Fabric | Select Frame |
|---------------------|--|--------------------|--------------------|--------------|
| | S Charcoal Urethane H Bourbon Cherry (+ \$100) F Shaker Cherry (+ \$100) C Harvest (+ \$100) D Natural Maple (+ \$100) N Mahogany (+ \$100) MOCH Mocha (+ \$100) COGN Cognac (+ \$100) PINC Pinnacle (+ \$100) LK11 Kingswood Walnut (+ \$100) LFW1 Florence Walnut (+ \$100) LSA1 Sterling Ash (+ \$100) | See page 460 | See page 460 | See page 460 |
| HHCG50DF | S | A190 | RS14 | PR8 |



HHCGB21

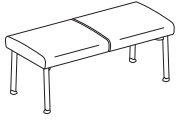

TWO-SEAT BENCH

DIMENSIONS

| | | | |
|-------------|-----|-----------------------|----------|
| Depth: | 20½ | Seat to Floor Height: | 17¾ |
| Width: | 44 | Usable Seat Depth: | 17¼ |
| Height: | 18¾ | Ship Weight: | 55 |
| Seat Width: | 22 | Cube: | 18.4 |
| | | COM: | 1.9 |
| | | Weight Rating: | 350 lbs. |

FABRIC PRICE CODES

| | | | |
|---|--------|----|--------|
| 1 | \$1365 | 8 | \$1572 |
| 2 | \$1401 | 9 | \$1599 |
| 3 | \$1437 | 10 | \$1626 |
| 4 | \$1464 | 11 | \$1653 |
| 5 | \$1491 | 12 | \$1680 |
| 6 | \$1518 | L | — |
| 7 | \$1545 | | |

ⓘ Benches cannot be ganged.

HHCGB31

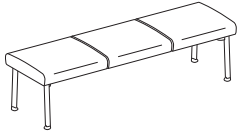

THREE-SEAT BENCH

DIMENSIONS

| | | | |
|-------------|-----|-----------------------|----------|
| Depth: | 20½ | Seat to Floor Height: | 17¾ |
| Width: | 66 | Usable Seat Depth: | 17¼ |
| Height: | 18¾ | Ship Weight: | 69 |
| Seat Width: | 22 | Cube: | 25.7 |
| | | COM: | 2.6 |
| | | Weight Rating: | 350 lbs. |

FABRIC PRICE CODES

| | | | |
|---|--------|----|--------|
| 1 | \$1756 | 8 | \$1963 |
| 2 | \$1792 | 9 | \$1990 |
| 3 | \$1828 | 10 | \$2017 |
| 4 | \$1855 | 11 | \$2044 |
| 5 | \$1882 | 12 | \$2071 |
| 6 | \$1909 | L | — |
| 7 | \$1936 | | |

ⓘ Benches cannot be ganged.

HOW TO SPECIFY

Select Model Number

HHCGB21

Select Fabric

See page 460

RS14

Select Frame

See page 460

PR8

HHCTS



IN-LINE TABLE TOP

DIMENSIONS

| | | | |
|---------|----|--------------|-----|
| Depth: | 22 | Ship Weight: | 8 |
| Width: | 16 | Cube: | 1.7 |
| Height: | 1½ | | |

LIST PRICE

\$385

NOTES: Can be ganged between two chairs or freestanding.

HHCTC



90-DEGREE RADIUS CORNER TABLE TOP

DIMENSIONS

| | | | |
|---------|----|--------------|-----|
| Depth: | 29 | Ship Weight: | 15 |
| Width: | 29 | Cube: | 2.4 |
| Height: | 1½ | | |

LIST PRICE

\$483

! Freestanding only.

HHCTRT



RECTANGLE TABLE TOP

DIMENSIONS

| | | | |
|---------|----|--------------|-----|
| Depth: | 22 | Ship Weight: | 20 |
| Width: | 40 | Cube: | 2.7 |
| Height: | 1½ | | |

LIST PRICE

\$642

! Freestanding only.

HHCTL4

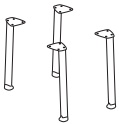

TABLE LEGS

Set of 4

DIMENSIONS

| | |
|--------------|-----|
| Ship Weight: | 8 |
| Cube: | 0.4 |

LIST PRICE

\$260

NOTES: Can be attached to any of the table tops above to create a freestanding table.

HOW TO SPECIFY

| | | | | | | | | | | | | |
|---|--|---|---|---|---|---|--|---|---|---|---|---|
| <p>Select Model Number</p> | <p>Select Laminate and Edge</p> <p>See page 461</p> | | | | | | | | | | | |
| <table border="1" style="border-collapse: collapse;"> <tr> <td style="padding: 2px 5px;">H</td> <td style="padding: 2px 5px;">H</td> <td style="padding: 2px 5px;">C</td> <td style="padding: 2px 5px;">T</td> <td style="padding: 2px 5px;">S</td> <td style="padding: 2px 5px;">.</td> </tr> </table> | H | H | C | T | S | . | <table border="1" style="border-collapse: collapse;"> <tr> <td style="padding: 2px 5px;">D</td> <td style="padding: 2px 5px;">W</td> <td style="padding: 2px 5px;">H</td> <td style="padding: 2px 5px;">I</td> <td style="padding: 2px 5px;">T</td> </tr> </table> | D | W | H | I | T |
| H | H | C | T | S | . | | | | | | | |
| D | W | H | I | T | | | | | | | | |

HOW TO SPECIFY

| | | | | | | | | | | | |
|--|--|---|---|---|---|---|---|--|---|---|---|
| <p>Select Model Number</p> | <p>Select Frame Color</p> <p>See page 460</p> | | | | | | | | | | |
| <table border="1" style="border-collapse: collapse;"> <tr> <td style="padding: 2px 5px;">H</td> <td style="padding: 2px 5px;">H</td> <td style="padding: 2px 5px;">C</td> <td style="padding: 2px 5px;">T</td> <td style="padding: 2px 5px;">L</td> <td style="padding: 2px 5px;">4</td> <td style="padding: 2px 5px;">.</td> </tr> </table> | H | H | C | T | L | 4 | . | <table border="1" style="border-collapse: collapse;"> <tr> <td style="padding: 2px 5px;">P</td> <td style="padding: 2px 5px;">R</td> <td style="padding: 2px 5px;">8</td> </tr> </table> | P | R | 8 |
| H | H | C | T | L | 4 | . | | | | | |
| P | R | 8 | | | | | | | | | |



HHCGBRCH

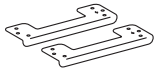

GANGING BRACKET

DIMENSIONS

Ship Weight: 2
Cube: 0.2

LIST PRICE

\$87

NOTES: For chair to chair connection. Does not connect a bench to other type of seating. Ganging brackets can be used with the seating models on pages 462-464. Bench models do not gang. Brackets are Charcoal only.

HHCGBR

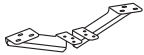

GANGING BRACKET

DIMENSIONS

Ship Weight: 5
Cube: 0.2

LIST PRICE

\$129

NOTES: For chair to table connection. Ganging brackets can be used with the seating models on pages 462-464. Bench models do not gang. Brackets are Charcoal only.

HOW TO SPECIFY

Select
Model Number

HHCGBRCH

TOPFLIGHT™ Wood Seating

OPEN MARKET



Icon Legend on page 17

HVL844



HIGH-BACK

Pneumatic
Swivel
Tilt
Tilt Tension
Tilt Lock
Fixed Padded Wood Arms and Base

Functions: **A, E, F, K, L**
(Function Key on pages 212-213)

DIMENSIONS

| | | | |
|--------------|---------------------------------|-----------------------|--|
| Depth: | 30 | Arm Width: | 20¼ |
| Width: | 28 | Seat to Floor Height: | 17 ³ / ₁₆ -21 ¹ / ₁₆ |
| Height: | 47 ⁵ / ₁₆ | Usable Seat Depth: | 17½ |
| Seat Depth: | 18½ | Ship Weight: | 58 |
| Seat Width: | 20½ | Cube: | 6.4 |
| Back Width: | 20½ | Weight Rating: | 250 lbs. |
| Back Height: | 27½ | | |

PRICE CODE

Leather **\$762**

NOTES: Wood accents available in Mahogany. High-back design. Black Bonded Leather. Tailored padded back design provides strong lumbar support. Fixed padded loop arms. Use with coordinated Guest Chair models HVL852 and HVL853 shown below. **HON 5-Year Limited Warranty.**

HON Recommendation: HVL844.N.SB11 - List Price \$762

HVL852



GUEST CHAIR

Leg Base
Arms
Upholstered Back
Wood Frame

DIMENSIONS

| | | | |
|--------------|-----|-----------------------|----------|
| Depth: | 22 | Arm Width: | 20 |
| Width: | 22½ | Seat to Floor Height: | 18½ |
| Height: | 31 | Usable Seat Depth: | 17 |
| Seat Depth: | 17 | Ship Weight: | 26 |
| Seat Width: | 20 | Cube: | 3.4 |
| Back Width: | 20 | Weight Rating: | 250 lbs. |
| Back Height: | 13 | | |

PRICE CODE

Leather **\$481**

NOTES: Wood frames available in Mahogany. Black Bonded Leather inset in back and on seat. Easier assembly – seat now attached to frame. **HON 5-Year Limited Warranty.**

HON Recommendation: HVL852.N.SB11 - List Price \$481

HVL853

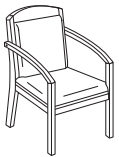

GUEST CHAIR

Leg Base
Arms
Upholstered Back
Wood Frame

DIMENSIONS

| | | | |
|--------------|-----|-----------------------|----------|
| Depth: | 23¾ | Arm Width: | 20¼ |
| Width: | 23¾ | Seat to Floor Height: | 19½ |
| Height: | 36¾ | Usable Seat Depth: | 18¼ |
| Seat Depth: | 18¼ | Ship Weight: | 35 |
| Seat Width: | 22 | Cube: | 6.9 |
| Back Width: | 18½ | Weight Rating: | 250 lbs. |
| Back Height: | 15¼ | | |

PRICE CODE

Leather **\$582**

NOTES: Wood frames available in Mahogany. Black Bonded Leather on fully-upholstered back panel and on seat. High-back design. **HON 5-Year Limited Warranty.**

HON Recommendation: HVL853.N.SB11 - List Price \$582

SEATING

HOW TO SPECIFY

Select
Model Number

H V L 8 4 4 .

Select
Wood Finish

N Mahogany

N .

Select
Fabric

SB11 Black Bonded Leather

S B 1 1



Icon Legend on page 17

TORCH™ Mesh Chairs

HVL511



MID-BACK

Pneumatic
Swivel
Tilt
Tilt Tension
Tilt Lock
Fixed Arms

Functions: **A, E, F, K, L**
(Function Key on pages 212-213)

DIMENSIONS

| | | | |
|--------------|-----|-----------------------|----------|
| Depth: | 26 | Arm Width: | 18¾ |
| Width: | 26 | Seat to Floor Height: | 16⅝-20⅝ |
| Height: | 40½ | Usable Seat Depth: | 18¾ |
| Seat Depth: | 18¾ | Ship Weight: | 30 |
| Seat Width: | 19½ | Cube: | 3.8 |
| Back Width: | 17¾ | Weight Rating: | 250 lbs. |
| Back Height: | 21¾ | | |

PRICE CODE

Fabric **\$318**

NOTES: Mid-back Mesh chair. Comfortable and breathable mesh back. Black fabric seat. Black frame. Fixed arms. **HON 5-Year Limited Warranty.**

HON Recommendation: HVL511.LH10 - List Price \$318

HVL515

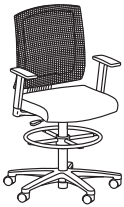

TASK STOOL

Pneumatic
Swivel
Fixed Arms

Functions: **A, E**
(Function Key on pages 212-213)

DIMENSIONS

| | | | |
|--------------|-----|-----------------------|----------|
| Depth: | 26 | Arm Width: | 18¾ |
| Width: | 26 | Seat to Floor Height: | 23⅝-33 |
| Height: | 52 | Usable Seat Depth: | 18¾ |
| Seat Depth: | 18¾ | Ship Weight: | 38 |
| Seat Width: | 19½ | Cube: | 4.6 |
| Back Width: | 17¾ | Weight Rating: | 250 lbs. |
| Back Height: | 21¾ | | |

PRICE CODE

Fabric **\$445**

NOTES: Comfortable and breathable mesh back. Black fabric seat. Fixed arms. **HON 5-Year Limited Warranty.**

HON Recommendation: HVL515.LH10 - List Price \$445

HOW TO SPECIFY

| | |
|----------------------------|----------------------|
| Select Model Number | Select Fabric |
| | LH10 Black Fabric |
| H V L 5 1 1 . | L H 1 0 |

TRACTION™ Executive Chairs

OPEN MARKET



Icon Legend on page 17

HVL103



HIGH-BACK

Pneumatic
Swivel
Tilt
Tilt Tension
Tilt Lock
Fixed Padded Arms

Functions: **A, E, F, K, L**
(Function Key on pages 212-213)

DIMENSIONS

| | | | |
|--------------|--------------------------------|-----------------------|------------------------------------|
| Depth: | 28 ³ / ₄ | Arm Width: | 18 ⁷ / ₈ |
| Width: | 26 ³ / ₄ | Seat to Floor Height: | 17 ¹ / ₄ -21 |
| Height: | 42 ¹ / ₂ | Usable Seat Depth: | 18 ¹ / ₄ |
| Seat Depth: | 18 ¹ / ₄ | Ship Weight: | 36.0 |
| Seat Width: | 19 ¹ / ₂ | Cube: | 4.1 |
| Back Width: | 19 ¹ / ₂ | Weight Rating: | 250 lbs. |
| Back Height: | 24 ⁷ / ₈ | | |

PRICE CODE

Leather **\$512**

NOTES: Black Bonded Leather. Polished base. Fixed, padded arms. **HON 5-Year Limited Warranty.**

HON Recommendation: HVL103.SB11 - List Price \$512

HVL102



HIGH-BACK MODERN GUEST CHAIR

Padded Arms
Cantilever Base

DIMENSIONS

| | | | |
|--------------|----------------------------------|-----------------------|----------------------------------|
| Depth: | 27 ¹ / ₆₄ | Arm Width: | 18 ⁴⁵ / ₆₄ |
| Width: | 20 ⁵ / ₆₄ | Seat to Floor Height: | 18 ²⁹ / ₃₂ |
| Height: | 39 ³ / ₈ | Usable Seat Depth: | 18 ⁷ / ₆₄ |
| Seat Depth: | 18 ⁷ / ₆₄ | Ship Weight: | 36.8 |
| Seat Width: | 19 ¹ / ₁₆ | Cube: | 4.4 |
| Back Width: | 18 ²⁹ / ₃₂ | Weight Rating: | 250 lbs. |
| Back Height: | 24 ³⁹ / ₆₄ | | |

PRICE CODE

Leather **\$370**

NOTES: Black Bonded Leather. Polished, cantilever base. Polished, padded arms. **HON 5-Year Limited Warranty.**

HON Recommendation: HVL102.SB11 - List Price \$370

SEATING

HOW TO SPECIFY

Select
Model Number

H V L 1 0 3 .

Select
Fabric

SB11 Black Bonded Leather
Specify for models HVL102 and HVL103 only

S B 1 1



HVL604



HIGH-BACK

Pneumatic
Swivel
Tilt
Tilt Tension
Tilt Lock
Fixed Arms

Functions: **A, E, F, K, L, T**
(Function Key on pages 212-213)

DIMENSIONS

| | | | |
|--------------|-----|-----------------------|----------|
| Depth: | 26½ | Arm Width: | 20½ |
| Width: | 25 | Seat to Floor Height: | 16¼-20¾ |
| Height: | 46½ | Usable Seat Depth: | 18¾ |
| Seat Depth: | 18¾ | Ship Weight: | 40 |
| Seat Width: | 19¾ | Cube: | 4.1 |
| Back Width: | 20 | Weight Rating: | 250 lbs. |
| Back Height: | 26½ | | |

PRICE CODE

Leather \$314

NOTES: Available in Black Bonded Leather SB11. High-back Executive Chair. Black frame. Fixed, tapered loop arms. Coordinating guest chair HVL605. **HON 5-Year Limited Warranty.**

HON Recommendation: HVL604.SB11 - List Price \$314

HVL605



GUEST CHAIR

Leg Base
Arms
Stacks up to Four High

DIMENSIONS

| | | | |
|--------------|-----|-----------------------|----------|
| Depth: | 24 | Arm Width: | 19½ |
| Width: | 23½ | Seat to Floor Height: | 18½ |
| Height: | 34½ | Usable Seat Depth: | 17½ |
| Seat Depth: | 17½ | Ship Weight: | 22.2 |
| Seat Width: | 18½ | Cube: | 3.0 |
| Back Width: | 18½ | Weight Rating: | 250 lbs. |
| Back Height: | 17¾ | | |

PRICE CODE

Leather \$302

NOTES: Validate™ HVL605 Guest Chair. Waterfall seat edge. Wall-saver design. Fixed arms. Stackable up to 4-high. Contemporary rectilinear steel frame in Matte Black. Use with coordinating Executive Chair model HVL604. **HON 5-Year Limited Warranty.**

HON Recommendation: HVL605.SB11 - List Price \$302

HVL685



HIGH-BACK

Pneumatic
Swivel
Tilt Tension
Tilt Lock
Fixed Padded Arms

Functions: **A, E, K, L**
(Function Key on pages 212-213)

DIMENSIONS

| | | | |
|-------------|-----|-----------------------|----------|
| Depth: | 32 | Back Height: | 28½ |
| Width: | 27½ | Seat to Floor Height: | 18¾-21¾ |
| Height: | 45 | Usable Seat Depth: | 20 |
| Seat Depth: | 20 | Ship Weight: | 67 |
| Seat Width: | 22¼ | Cube: | 9.5 |
| Back Width: | 21 | Weight Rating: | 450 lbs. |

PRICE CODE

Leather \$1014

NOTES: Large scale model HVL685 will support up to 450 lbs with normal use. Available in Black Bonded Leather SB11. **HON 5-Year Limited Warranty.**

HON Recommendation: HVL685.SB11 - List Price \$1014

HOW TO SPECIFY

| | |
|----------------------------|---------------------------|
| Select Model Number | Select Fabric |
| | SB11 Black Bonded Leather |
| H V L 6 0 4 . | S B 1 1 |



HVL205



LOW-BACK

Pneumatic
Swivel
Tilt
Tilt Tension
Tilt Lock

DIMENSIONS

| | | | |
|-------------|-----|-----------------------|----------|
| Depth: | 23 | Back Height: | 18 |
| Width: | 23 | Seat to Floor Height: | 15¼-19¼ |
| Height: | 39½ | Usable Seat Depth: | 18 |
| Seat Depth: | 18 | Ship Weight: | 29 |
| Seat Width: | 19 | Cube: | 3.2 |
| Back Width: | 18 | Weight Rating: | 250 lbs. |

PRICE CODE

Mesh **\$286**

NOTES: Comfortable and breathable mesh back. Black Sandwich Mesh seat. Black frame. **HON 5-Year Limited Warranty.**

HON Recommendation: HVL205.MM10.T - List Price \$286

HVL210



TASK LOW-BACK

Pneumatic
Swivel
Tilt
Tilt Tension
Tilt Lock
Functions: **A, E, F, K, L**
(Function Key on pages 212-213)

DIMENSIONS

| | | | |
|-------------|-----|-----------------------|----------|
| Depth: | 33½ | Back Height: | 20¼ |
| Width: | 24½ | Seat to Floor Height: | 17-20½ |
| Height: | 38¼ | Usable Seat Depth: | 17¾ |
| Seat Depth: | 17¾ | Ship Weight: | 31 |
| Seat Width: | 19¾ | Cube: | 3.6 |
| Back Width: | 19¾ | Weight Rating: | 250 lbs. |

PRICE CODE

Sandwich Mesh **\$261**

NOTES: Black Sandwich Mesh. Sturdy textured black frame. HVL995 optional arm pack available. **HON 5-Year Limited Warranty.**

HON Recommendation: HVL210.MM10 - List Price \$261

HVL215

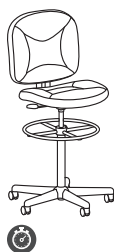

TASK STOOL

Pneumatic
Swivel
Functions: **A, E**
(Function Key on pages 212-213)

DIMENSIONS

| | | | |
|-------------|-----|-----------------------|----------|
| Depth: | 33½ | Back Height: | 19 |
| Width: | 24½ | Seat to Floor Height: | 24½-33½ |
| Height: | 51⅞ | Usable Seat Depth: | 17¾ |
| Seat Depth: | 17¾ | Ship Weight: | 37 |
| Seat Width: | 19¾ | Cube: | 5.7 |
| Back Width: | 19¾ | Weight Rating: | 250 lbs. |

PRICE CODE

Sandwich Mesh **\$363**

NOTES: Black Sandwich Mesh. Sturdy textured black frame. HVL995 optional arm pack available. **HON 5-Year Limited Warranty.**

HON Recommendation: HVL215.MM10 - List Price \$363

HVL995

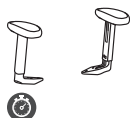

HEIGHT-ADJUSTABLE ARMS

Functions: **Q**
(Function Key on pages 212-213)

DIMENSIONS

| | |
|------------------------|------|
| Adjustable Arms Width: | 18¾ |
| Height from Seat: | 8-11 |
| Ship Weight: | 7 |
| Cube: | 0.6 |

LIST PRICE

\$108

NOTES: Arm color is black. Height-adjustable. Compatible with HVL205, HVL210, and HVL215. **HON 5-Year Limited Warranty.**

HON Recommendation: HVL995 - List Price \$108

HOW TO SPECIFY

| | | |
|---|--|---|
| <p>Select Model Number</p> <p>H V L 2 0 5 .</p> | <p>Select Fabric</p> <p>MM10 Black Sandwich Mesh Fabric</p> <p>M M 1 0 .</p> | <p>Select Frame</p> <p>T Black Specify frame color for model HVL205 only</p> <p>T</p> |
|---|--|---|

VERSANT® TANDEM

Want to see more? Scan here
to check out hon.com.



Versant® Tandem Seating and Laminate Occasional Tables.

VERSANT® TANDEM

Everyone deserves a break from time to time, and a comfy seat in which to enjoy one. Bring stylish support to your welcome areas, public spaces and breakrooms with Versant. With a combination of tandem seats and bariatric chairs, it's ideal for both healthcare environments and offices. Arched arms support the upper body and padded seats put people at ease for longer periods of time. Versant brings versatility to every corner of your space.



FEATURES

- Stylish arched arm offers greater upper body support.
- Seats are removable for easy cleaning and replacement.
- Contrasting covers are available as special order (please contact customer service).
- Solid hardwood in one of eight attractive finishes.
- Available in hundreds of quality HON fabrics.
- Warranted for users up to 350 lbs. (Model HHCB50 is warranted for users up to 500 lbs.)

VERSANT® Tandem Options

MODEL OPTIONS

HHB02

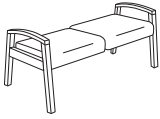

Two-Seat Bench

HHB03

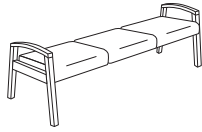

Three-Seat Bench

HHCT01

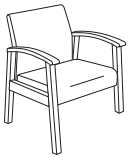

Single Seat

Leg Base, Arms

HHCT02

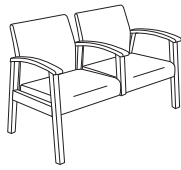

Two-Seat

Leg Base, Center Arm, Arms

HHCT12

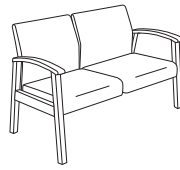

Two-Seat

Leg Base, Arms

HHCB50

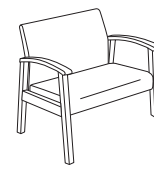

Bariatric Chair

Leg Base, Arms

AVAILABLE FINISHES

Versant® Tandem Seating is available in 8 wood finishes.

WOOD FINISHES

Bourbon Cherry (H)
Cognac (COGN)
Harvest (C)
Mahogany (N)
Mocha (MOCH)
Natural Maple (D)
Pinnacle (PINC)
Shaker Cherry (F)

AVAILABLE LAMINATES

Versant® Tandem Laminate Occasional Tables are available in 8 laminates.

LAMINATES

Bourbon Cherry (H)
Cognac (COGN)
Harvest (C)
Mahogany (N)
Mocha (MOCH)
Natural Maple (D)
Pinnacle (PINC)
Shaker Cherry (F)

HON BRANDED FABRICS

GRADE 1

Apex
Attire
Centurion
Contourett
Dapper
Ensemble
Hamilton
Inertia
Optic
Pebble

GRADE 2

Appoint Seating
Blume
Clyde
Dotty
Rush
Seed
Spin Seating
Whisper Vinyl

GRADE 3

In Season
Moxie
Parker
Purl
Quill

For a complete list of fabrics, including partnership fabrics, go to hon.com/fabricsandfinishes.

Reference Fabric Color Combinations on pages 18-22 for color codes and legend on page 19 for lead times. Contrasting covers on seat and back are available as special order. Please contact Customer Service. For additional HON to Supply COM fabric grade pricing, go to honready.hon.com and click on the HON to Supply COM link.



VERSANT® TANDEM

HHB02



TWO-SEAT BENCH

DIMENSIONS

| | | | |
|------------------|--------------------------------|-----------------------|--------------------------------|
| Depth: | 20 ³ / ₈ | Seat to Floor Height: | 19 ¹ / ₂ |
| Width: | 45 ¹ / ₂ | Usable Seat Depth: | 19 ³ / ₄ |
| Height: | 23 | Ship Weight: | 62 |
| Each Seat Depth: | 20 ³ / ₈ | Cube: | 16.2 |
| Each Seat Width: | 21 ¹ / ₂ | COM: | 2.0 |
| Arm Width: | 42 ¹ / ₂ | Weight Rating: | 350 lbs. (per seat) |

FABRIC PRICE CODES

| | | | |
|---|--------|----|--------|
| 1 | \$1845 | 8 | \$2121 |
| 2 | \$1893 | 9 | \$2157 |
| 3 | \$1941 | 10 | \$2193 |
| 4 | \$1977 | 11 | \$2229 |
| 5 | \$2013 | 12 | \$2265 |
| 6 | \$2049 | L | \$2245 |
| 7 | \$2085 | | |

HHB03

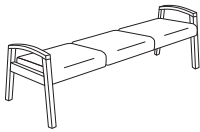

THREE-SEAT BENCH

DIMENSIONS

| | | | |
|------------------|--------------------------------|-----------------------|--------------------------------|
| Depth: | 20 ³ / ₈ | Seat to Floor Height: | 19 ¹ / ₂ |
| Width: | 66 ¹ / ₂ | Usable Seat Depth: | 19 ³ / ₄ |
| Height: | 23 | Ship Weight: | 80 |
| Each Seat Depth: | 20 ³ / ₈ | Cube: | 24.5 |
| Each Seat Width: | 21 ¹ / ₂ | COM: | 2.5 |
| Arm Width: | 63 ¹ / ₂ | Weight Rating: | 350 lbs. (per seat) |

FABRIC PRICE CODES

| | | | |
|---|--------|----|--------|
| 1 | \$2371 | 8 | \$2716 |
| 2 | \$2431 | 9 | \$2761 |
| 3 | \$2491 | 10 | \$2806 |
| 4 | \$2536 | 11 | \$2851 |
| 5 | \$2581 | 12 | \$2896 |
| 6 | \$2626 | L | \$2871 |
| 7 | \$2671 | | |

HON Recommendation: HHB02.MOCH.SX__ - List Price \$1941

HOW TO SPECIFY

| | | |
|--|---|--|
| <p>Select Model Number</p> <p>HHB02</p> | <p>Select Finish</p> <p>See page 474</p> <p>MOCH</p> | <p>Select Seat Fabric</p> <p>See page 474</p> <p>SX05</p> |
|--|---|--|

VERSANT® TANDEM

Laminate Occasional Tables

OPEN MARKET



Icon Legend on page 17

HHCT048

COFFEE TABLE

DIMENSIONS

LIST PRICE

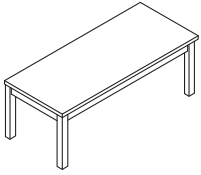

| | | | |
|---------|----|--------------|-----|
| Length: | 48 | Ship Weight: | 44 |
| Width: | 20 | Cube: | 3.0 |
| Height: | 17 | | |

\$744

HHCT024

CORNER TABLE

DIMENSIONS

LIST PRICE

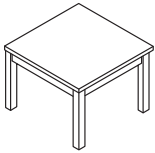

| | | | |
|---------|----|--------------|-----|
| Length: | 24 | Ship Weight: | 20 |
| Width: | 24 | Cube: | 1.4 |
| Height: | 17 | | |

\$623

HHCT020

END TABLE

DIMENSIONS

LIST PRICE

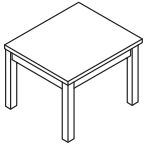

| | | | |
|---------|----|--------------|-----|
| Length: | 24 | Ship Weight: | 22 |
| Width: | 20 | Cube: | 1.4 |
| Height: | 17 | | |

\$585

HON Recommendation: HHCT024.MOCH - List Price \$623

SEATING

HOW TO SPECIFY

Select Model Number

Select Laminate

See page 474

HHCT048

MOCH



Icon Legend on page 17

VERSANT® TANDEM

HHCT01



SINGLE SEAT

Leg Base
Arms

DIMENSIONS

| | | | |
|--------------|-----|-----------------------|----------|
| Depth: | 27 | Arm Width: | 20½ |
| Width: | 25 | Seat to Floor Height: | 18 |
| Height: | 34 | Usable Seat Depth: | 19¼ |
| Seat Depth: | 20¼ | Ship Weight: | 57 |
| Seat Width: | 21 | Cube: | 20.1 |
| Back Width: | 21 | COM: | 2.0 |
| Back Height: | 17 | Weight Rating: | 350 lbs. |

FABRIC PRICE CODES

| | | | |
|---|--------|----|--------|
| 1 | \$1407 | 8 | \$1683 |
| 2 | \$1455 | 9 | \$1719 |
| 3 | \$1503 | 10 | \$1755 |
| 4 | \$1539 | 11 | \$1791 |
| 5 | \$1575 | 12 | \$1827 |
| 6 | \$1611 | L | \$1807 |
| 7 | \$1647 | | |

HHCT02

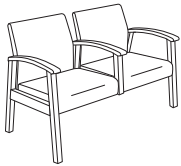

TWO-SEAT

Leg Base
Center Arm
Arms

DIMENSIONS

| | | | |
|-------------------|-----|-----------------------|------------|
| Depth: | 27 | Seat to Floor Height: | 18 |
| Width: | 47½ | Usable Seat Depth: | 19¼ |
| Height: | 34 | Ship Weight: | 87 |
| Each Seat Depth: | 20¼ | Cube: | 33.7 |
| Each Seat Width: | 21 | COM: | 3.5 |
| Each Back Width: | 21 | Weight Rating: | 350 lbs. |
| Each Back Height: | 17 | | (per seat) |

FABRIC PRICE CODES

| | | | |
|---|--------|----|--------|
| 1 | \$2455 | 8 | \$2938 |
| 2 | \$2539 | 9 | \$3001 |
| 3 | \$2623 | 10 | \$3064 |
| 4 | \$2686 | 11 | \$3127 |
| 5 | \$2749 | 12 | \$3190 |
| 6 | \$2812 | L | \$3155 |
| 7 | \$2875 | | |

HHCT12

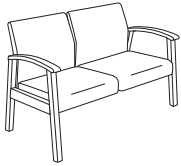

TWO-SEAT

Leg Base
Arms

DIMENSIONS

| | | | |
|-------------------|-----|-----------------------|------------|
| Depth: | 27 | Arm Width: | 41½ |
| Width: | 46 | Seat to Floor Height: | 18 |
| Height: | 34 | Usable Seat Depth: | 19¼ |
| Each Seat Depth: | 20¼ | Ship Weight: | 87 |
| Each Seat Width: | 21 | Cube: | 33.0 |
| Each Back Width: | 21 | COM: | 3.5 |
| Each Back Height: | 17 | Weight Rating: | 350 lbs. |
| | | | (per seat) |

FABRIC PRICE CODES

| | | | |
|---|--------|----|--------|
| 1 | \$2349 | 8 | \$2832 |
| 2 | \$2433 | 9 | \$2895 |
| 3 | \$2517 | 10 | \$2958 |
| 4 | \$2580 | 11 | \$3021 |
| 5 | \$2643 | 12 | \$3084 |
| 6 | \$2706 | L | \$3049 |
| 7 | \$2769 | | |

HHCB50

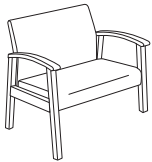

BARIATRIC SINGLE SEAT

Leg Base
Arms

DIMENSIONS

| | | | |
|-------------------|-----|-----------------------|----------|
| Depth: | 27 | Arm Width: | 29 |
| Width: | 33½ | Seat to Floor Height: | 18 |
| Height: | 34 | Usable Seat Depth: | 19¼ |
| Each Seat Depth: | 20¼ | Ship Weight: | 80 |
| Each Seat Width: | 30 | Cube: | 29.0 |
| Each Back Width: | 30 | COM: | 3.0 |
| Each Back Height: | 17 | Weight Rating: | 500 lbs. |

FABRIC PRICE CODES

| | | | |
|---|--------|----|--------|
| 1 | \$2105 | 8 | \$2519 |
| 2 | \$2177 | 9 | \$2573 |
| 3 | \$2249 | 10 | \$2627 |
| 4 | \$2303 | 11 | \$2681 |
| 5 | \$2357 | 12 | \$2735 |
| 6 | \$2411 | L | \$2705 |
| 7 | \$2465 | | |

HON Recommendation: HHCT01.MOCH.SX__ - List Price \$1503

HOW TO SPECIFY

| | | |
|---|---|--|
| <p>Select Model Number</p> <p>HHCT01</p> | <p>Select Finish</p> <p>MOCH</p> <p>See page 474</p> | <p>Select Seat Fabric</p> <p>SX05</p> <p>See page 474</p> |
|---|---|--|



Volt® Task Chairs and Stools
shown with Voi® Desks.

VOLT®

Customizable comfort, distinctive styling and an affordable price point make Volt the family of task seating that supports your body and your budget. The stylish V-shaped back design can be specified in fabric, leather or breathable mesh, giving you more control over your look and feel. The personalized controls and generously proportioned seat and back deliver greater comfort, and are designed support to a wider variety of users. Volt delivers the look you desire, the comfort you demand, and the quality you expect. That's the power of practicality.

SEATING



FEATURES

- Optional synchro-tilt control provides a smooth, natural recline.
- Optional height-adjustable arms provide a custom fit.
- Optional mesh back offers breathable support.
- Task stools feature an adjustable footring for additional lower body support.
- One-touch seat height adjustment easily moves the seat up and down.
- Tilt tension controls the rate and ease of recline.
- Tilt lock allows the user to lock out the tilt function.
- 360-degree swivel provides freedom of movement in any direction.
- Select models available in hundreds of quality HON fabrics.
- Warranted for users up to 275 lbs.

VOLT® 5700/5710 Series Options

MODEL OPTIONS

H5701



Task Chair

Pneumatic, Swivel, Tilt, Tilt Tension, Tilt Lock

H5703



Task Chair

Pneumatic, Swivel, Synchro-tilt, Tilt Tension, Tilt Lock

H5705



Task Stool

Pneumatic, Swivel, Adjustable Footring

H5711



Task Chair (Mesh Back)

Pneumatic, Swivel, Tilt, Tilt Tension, Tilt Lock

H5713



Task Chair (Mesh Back)

Pneumatic, Swivel, Synchro-tilt, Tilt Tension, Tilt Lock

H5715



Task Stool (Mesh Back)

Pneumatic, Swivel, Adjustable Footring

HON BRANDED FABRICS

GRADE 1

Black Fabric
Navy Fabric

GRADE 2

GRADE 3

For a complete list of fabrics, including partnership fabrics, go to hon.com/fabricsandfinishes.

Navy only available on select models.

Reference Fabric Color Combinations on pages 18-22 for color codes and legend on page 19 for lead times.

VOLT® 5700 Series

OPEN MARKET



Icon Legend on page 17

H5701



TASK CHAIR

Pneumatic
Swivel
Tilt
Tilt Tension
Tilt Lock
Functions: **A, E, F, K, L**
(Function Key on pages 212-213)

DIMENSIONS

Depth: 25³/₄
Width: 26
Height: 40
Seat Depth: 18³/₄
Seat Width: 18¹/₂
Back Width: 17¹/₄
Back Height: 18³/₄
Seat to Floor Height: 18-22¹/₄
Usable Seat Depth: 18³/₄
Ship Weight: 29
Cube: 5.1
Weight Rating: 275 lbs.

FABRIC PRICE CODES

1 \$312 L \$342

H5703



TASK CHAIR

Pneumatic
Swivel
Synchro-tilt
Tilt Tension
Tilt Lock
Functions: **A, E, J, K, L**
(Function Key on pages 212-213)

DIMENSIONS

Depth: 25³/₄
Width: 26
Height: 40
Seat Depth: 18³/₄
Seat Width: 18¹/₂
Back Width: 17¹/₄
Back Height: 18³/₄
Seat to Floor Height: 18-22¹/₄
Usable Seat Depth: 18³/₄
Ship Weight: 29
Cube: 5.1
Weight Rating: 275 lbs.

FABRIC PRICE CODES

1 \$362 L \$392

H5705



TASK STOOL

Pneumatic
Swivel
Adjustable Footring
Functions: **A, E**
(Function Key on pages 212-213)

DIMENSIONS

Depth: 29¹/₂
Width: 27
Height: 49⁷/₈
Seat Depth: 20
Seat Width: 19
Back Width: 16¹/₂
Back Height: 20
Seat to Floor Height: 22⁷/₈-32³/₈
Usable Seat Depth: 18
Ship Weight: 36
Cube: 6.0
Weight Rating: 275 lbs.

FABRIC PRICE CODES

1 \$511 L \$541

H5795

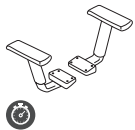

HEIGHT-ADJUSTABLE ARMS

Non-upholstered
Functions: **Q**
(Function Key on pages 212-213)

DIMENSIONS

Adjustable Arms Width: 17³/₈
Height from Seat: 7⁵/₈-10⁵/₈
Ship Weight: 5
Cube: 0.6

LIST PRICE

\$98

HON Recommendation: H5703.GA10.T with H5795 Arm Pack - List Price \$460

HOW TO SPECIFY

Select
Model Number

H 5 7 0 3 .

Select
Fabric

SB11 Black Bonded Leather
GA10 Black
GA90 Navy (only available on H5701)

G A 1 0 .

Select
Frame

T Black

T



VOLT® 5710 Series

H5711



TASK CHAIR

Mesh Back
Pneumatic
Swivel
Tilt
Tilt Tension
Tilt Lock
Functions: **A, E, F, K, L**
(Function Key on pages 212-213)

DIMENSIONS

Depth: 25³/₄ Seat to Floor Height: 18³/₄-22³/₈
Width: 26 Usable Seat Depth: 18
Height: 38³/₄ Ship Weight: 29
Seat Depth: 18³/₄ Cube: 5.1
Seat Width: 19¹/₄ Weight Rating: 275 lbs.
Back Width: 18
Back Height: 18³/₄

FABRIC PRICE CODES

1 \$431 L \$461

H5713



TASK CHAIR

Mesh Back
Pneumatic
Swivel
Synchro-tilt
Tilt Tension
Tilt Lock
Functions: **A, E, J, K, L**
(Function Key on pages 212-213)

DIMENSIONS

Depth: 25³/₄ Seat to Floor Height: 17³/₈-21¹/₈
Width: 26 Usable Seat Depth: 17⁷/₈
Height: 38¹/₂ Ship Weight: 32
Seat Depth: 18³/₄ Cube: 5.1
Seat Width: 19¹/₄ Weight Rating: 275 lbs.
Back Width: 18
Back Height: 18³/₄

FABRIC PRICE CODES

1 \$485 L \$515

H5715



TASK STOOL

Mesh Back
Pneumatic
Swivel
Adjustable Footring
Functions: **A, E**
(Function Key on pages 212-213)

DIMENSIONS

Depth: 28 Seat to Floor Height: 22⁷/₈-32³/₈
Width: 26 Usable Seat Depth: 18
Height: 49⁷/₈ Ship Weight: 36
Seat Depth: 20 Cube: 6.0
Seat Width: 19 Weight Rating: 275 lbs.
Back Width: 18
Back Height: 18¹/₂

FABRIC PRICE CODES

1 \$637 L \$667

H5795

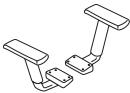

HEIGHT-ADJUSTABLE ARMS

Non-upholstered
Functions: **Q**
(Function Key on pages 212-213)

DIMENSIONS

Adjustable Arms Width: 17³/₈
Height from Seat: 7³/₈-10⁵/₈
Ship Weight: 5
Cube: 0.6

LIST PRICE

\$98

HON Recommendation: H5713.GA10.T with H5795 Arm Pack - List Price \$583

HOW TO SPECIFY

| | | |
|--|---|---|
| <p>Select Model Number</p> <p>H 5 7 1 3</p> | <p>Select Fabric</p> <p>SB11 Black Leather GA10 Black</p> <p>G A 1 0</p> | <p>Select Frame</p> <p>T Black</p> <p>T</p> |
|--|---|---|

VOLT® 5720/5730 Series Options

MODEL OPTIONS

H5721



Task Chair

Pneumatic, Swivel, Tilt, Tilt Tension, Tilt Lock

H5723



Task Chair

Pneumatic, Swivel, Synchro-tilt, Tilt Tension, Tilt Lock

H5725



Task Stool

Pneumatic, Swivel, Adjustable Footring

H5731



Task Chair (Mesh Back)

Pneumatic, Swivel, Tilt, Tilt Tension, Tilt Lock

H5733



Task Chair (Mesh Back)

Pneumatic, Swivel, Synchro-tilt, Tilt Tension, Tilt Lock

H5735



Task Stool (Mesh Back)

Pneumatic, Swivel, Adjustable Footring

CASTERS



| CODE | DESCRIPTION | PRICE |
|----------|-------------------|-------------|
| H | Black Hard Caster | +\$0 |



| | | |
|----------|--------------------------|--------------|
| S | Black All-Surface Caster | +\$30 |
|----------|--------------------------|--------------|

FRAME

| CODE | DESCRIPTION | PRICE |
|----------|-------------|-------------|
| T | Black | +\$0 |

5720/5730 Series Fabric Options

HON BRANDED FABRICS

GRADE 1

Apex
Attire
Centurion
Compass
Contourett
Dapper
Ensemble
Hamilton
Inertia
Optic
Pebble

GRADE 2

Appoint Seating
Blume
Clyde
Dotty
Rush
Seed
Spin Seating
Whisper Vinyl

GRADE 3

In Season
Moxie
Parker
Purl
Quill

For a complete list of fabrics, including partnership fabrics, go to hon.com/fabricsandfinishes.

Reference Fabric Color Combinations on pages 18-22 for color codes and legend on page 19 for lead times. For additional HON to Supply COM fabric grade pricing, go to honready.hon.com and click on the HON to Supply COM link.

VOLT® 5720 Series

GSA SIN 33721 EXCEPT AS NOTED



Icon Legend on page 17

H5721



TASK CHAIR

Pneumatic
Swivel
Tilt
Tilt Tension
Tilt Lock
Functions: **A, E, F, K, L**
(Function Key on pages 212-213)

DIMENSIONS

Depth: 25³/₄ Seat to Floor Height: 17¹/₄-22¹/₄
Width: 25³/₄ Usable Seat Depth: 18³/₄
Height: 40 Ship Weight: 36
Seat Depth: 18³/₄ Cube: 5.1
Seat Width: 18¹/₂ COM: 1.5
Back Width: 17¹/₄ Weight Rating: 275 lbs.
Back Height: 18³/₄

FABRIC PRICE CODES

| | | | |
|---|-------|----|-------|
| 1 | \$410 | 8 | \$548 |
| 2 | \$434 | 9 | \$566 |
| 3 | \$458 | 10 | \$584 |
| 4 | \$476 | 11 | \$602 |
| 5 | \$494 | 12 | \$620 |
| 6 | \$512 | L | — |
| 7 | \$530 | | |

H5723



TASK CHAIR

Pneumatic
Swivel
Synchro-tilt
Tilt Tension
Tilt Lock
Functions: **A, E, J, K, L**
(Function Key on pages 212-213)

DIMENSIONS

Depth: 25³/₄ Seat to Floor Height: 17¹/₄-22¹/₄
Width: 25³/₄ Usable Seat Depth: 18³/₄
Height: 40 Ship Weight: 38
Seat Depth: 18³/₄ Cube: 5.1
Seat Width: 18¹/₂ COM: 1.5
Back Width: 17¹/₄ Weight Rating: 275 lbs.
Back Height: 18³/₄

FABRIC PRICE CODES

| | | | |
|---|-------|----|-------|
| 1 | \$456 | 8 | \$594 |
| 2 | \$480 | 9 | \$612 |
| 3 | \$504 | 10 | \$630 |
| 4 | \$522 | 11 | \$648 |
| 5 | \$540 | 12 | \$666 |
| 6 | \$558 | L | — |
| 7 | \$576 | | |

H5725

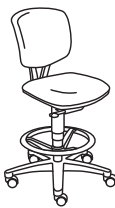

TASK STOOL

Pneumatic
Swivel
Adjustable Footring
Functions: **A, E**
(Function Key on pages 212-213)

DIMENSIONS

Depth: 29¹/₂ Seat to Floor Height: 22⁷/₈-32³/₈
Width: 27 Usable Seat Depth: 18³/₄
Height: 49⁷/₈ Ship Weight: 39
Seat Depth: 20 Cube: 6.0
Seat Width: 19 COM: 1.5
Back Width: 17¹/₄ Weight Rating: 275 lbs.
Back Height: 18³/₄

FABRIC PRICE CODES

| | | | |
|---|-------|----|-------|
| 1 | \$594 | 8 | \$732 |
| 2 | \$618 | 9 | \$750 |
| 3 | \$642 | 10 | \$768 |
| 4 | \$660 | 11 | \$786 |
| 5 | \$678 | 12 | \$804 |
| 6 | \$696 | L | — |
| 7 | \$714 | | |

H5795

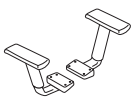

OPEN MARKET

HEIGHT-ADJUSTABLE ARMS

Non-upholstered
Functions: **Q**
(Function Key on pages 212-213)

DIMENSIONS

Adjustable Arms Width: 17³/₈
Height from Seat: 7⁷/₈-10⁵/₈
Ship Weight: 5
Cube: 0.6

LIST PRICE

\$98

HSCASTER

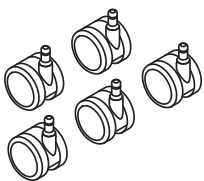

OPEN MARKET

SET OF 5 ALL-SURFACE CASTERS

Available in Black finish only, no specification needed.

DIMENSIONS

Size: 60mm
Ship Weight: 2
Cube: 0.1

LIST PRICE

\$59

HON Recommendation: H5723.H.CU__T with H5795 Arm Pack - List Price \$554

HOW TO SPECIFY

| | | | |
|---|--|--|-------------------------------------|
| Select Model Number H 5 7 2 3 . | Select Caster H Black Hard Caster S Black All-Surface Caster (+ \$40) | Select Fabric See page 483 CU 1 0 . | Select Frame T Black T |
|---|--|--|-------------------------------------|



H5731



TASK CHAIR

Mesh Back
Pneumatic
Swivel
Tilt
Tilt Tension
Tilt Lock
Functions: **A, E, F, K, L**
(Function Key on pages 212-213)

DIMENSIONS

Depth: 25³/₄ Seat to Floor Height: 18³/₄-22³/₈
Width: 26 Usable Seat Depth: 18
Height: 38³/₄ Ship Weight: 29
Seat Depth: 18³/₄ Cube: 5.1
Seat Width: 19¹/₄ COM: 1.5
Back Width: 18 Weight Rating: 275 lbs.
Back Height: 18³/₄

FABRIC PRICE CODES

| | | | |
|---|-------|----|-------|
| 1 | \$532 | 8 | \$601 |
| 2 | \$544 | 9 | \$610 |
| 3 | \$556 | 10 | \$619 |
| 4 | \$565 | 11 | \$628 |
| 5 | \$574 | 12 | \$637 |
| 6 | \$583 | L | — |
| 7 | \$592 | | |

H5733



TASK CHAIR

Mesh Back
Pneumatic
Swivel
Synchro-tilt
Tilt Tension
Tilt Lock
Functions: **A, E, J, K, L**
(Function Key on pages 212-213)

DIMENSIONS

Depth: 25³/₄ Seat to Floor Height: 17³/₈-21¹/₈
Width: 26 Usable Seat Depth: 17⁷/₈
Height: 38¹/₂ Ship Weight: 32
Seat Depth: 18³/₄ Cube: 5.1
Seat Width: 19¹/₄ COM: 1.5
Back Width: 18 Weight Rating: 275 lbs.
Back Height: 18³/₄

FABRIC PRICE CODES

| | | | |
|---|-------|----|-------|
| 1 | \$582 | 8 | \$651 |
| 2 | \$594 | 9 | \$660 |
| 3 | \$606 | 10 | \$669 |
| 4 | \$615 | 11 | \$678 |
| 5 | \$624 | 12 | \$687 |
| 6 | \$633 | L | — |
| 7 | \$642 | | |

H5735



TASK STOOL

Mesh Back
Pneumatic
Swivel
Adjustable Footring
Functions: **A, E**
(Function Key on pages 212-213)

DIMENSIONS

Depth: 28 Seat to Floor Height: 22⁷/₈-32³/₈
Width: 26 Usable Seat Depth: 18
Height: 49⁷/₈ Ship Weight: 36
Seat Depth: 20 Cube: 6.0
Seat Width: 19 COM: 1.5
Back Width: 18 Weight Rating: 275 lbs.
Back Height: 18¹/₂

FABRIC PRICE CODES

| | | | |
|---|-------|----|-------|
| 1 | \$723 | 8 | \$792 |
| 2 | \$735 | 9 | \$801 |
| 3 | \$747 | 10 | \$810 |
| 4 | \$756 | 11 | \$819 |
| 5 | \$765 | 12 | \$828 |
| 6 | \$774 | L | — |
| 7 | \$783 | | |

H5795

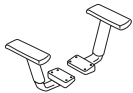

HEIGHT-ADJUSTABLE ARMS

Non-upholstered
Functions: **Q**
(Function Key on pages 212-213)

DIMENSIONS

Adjustable Arms Width: 17³/₈
Height from Seat: 7³/₈-10³/₈
Ship Weight: 5
Cube: 0.6

LIST PRICE

\$98

HSCASTER

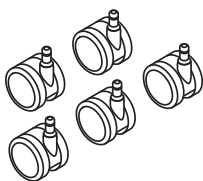

SET OF 5 ALL-SURFACE CASTERS

i Available in Black finish only, no specification needed.

DIMENSIONS

Size: 60mm
Ship Weight: 2
Cube: 0.1

LIST PRICE

\$59

HON Recommendation: H5733.H.CU__T with H5795 Arm Pack - List Price \$680

HOW TO SPECIFY

| | | | |
|---|--|---|---|
| <p>Select Model Number</p> <p>H 5 7 3 3</p> | <p>Select Caster</p> <p>H Black Hard Caster S Black All-Surface Caster (+ \$40)</p> <p>H</p> | <p>Select Fabric</p> <p>See page 483</p> <p>C U 1 0</p> | <p>Select Frame</p> <p>T Black</p> <p>T</p> |
|---|--|---|---|

WAVE™ Mesh Chairs

GSA SIN AS NOTED



Icon Legend on page 17

HVL701



SIN 33721

HIGH-BACK

Pneumatic
Swivel
Knee Tilt
Tilt Tension
Infinite Tilt Lock
Adjustable Lumbar
Height-adjustable Arms

Functions: **A, E, H, K, L, Q, W**
(Function Key on pages 212-213)

DIMENSIONS

| | | | |
|--------------|-----|-----------------------|----------|
| Depth: | 28 | Arm Width: | 19½ |
| Width: | 27½ | Seat to Floor Height: | 18½-21¼ |
| Height: | 44⅝ | Usable Seat Depth: | 19¼ |
| Seat Depth: | 20¾ | Ship Weight: | 53 |
| Seat Width: | 22 | Cube: | 5.8 |
| Back Width: | 23 | Weight Rating: | 250 lbs. |
| Back Height: | 23¾ | | |

PRICE CODE

Leather **\$756**

NOTES: Comfortable and breathable mesh back. Sturdy textured black frame. HVL701 has a Black leather upholstered seat with side mesh panels. Adjustable lumbar support. **HON 5-Year Limited Warranty.**

HON Recommendation: HVL701.SB11 - List Price \$756

HVL702



OPEN MARKET

HIGH-BACK

Pneumatic
Swivel
Synchro-tilt
Tilt Tension
Tilt Lock
Height-adjustable Arms

Functions: **A, E, J, K, L, Q**
(Function Key on pages 212-213)

DIMENSIONS

| | | | |
|--------------|-----|-----------------------|----------|
| Depth: | 26½ | Arm Width: | 19½ |
| Width: | 26½ | Seat to Floor Height: | 18½-23½ |
| Height: | 40½ | Usable Seat Depth: | 19¾ |
| Seat Depth: | 19¾ | Ship Weight: | 40 |
| Seat Width: | 21 | Cube: | 5.0 |
| Back Width: | 19½ | Weight Rating: | 250 lbs. |
| Back Height: | 24 | | |

PRICE CODE

Sandwich Mesh **\$613**

NOTES: Black Sandwich Mesh seat and mesh back. **HON 5-Year Limited Warranty.**

HON Recommendation: HVL702.MM10 - List Price \$613

HVL705



OPEN MARKET

EXECUTIVE BIG AND TALL

Pneumatic
Knee Tilt
Tilt Tension
Tilt Lock
Height and Width Adjustable Arms
Integrated Lumbar Support

Functions: **A, E, H, K, L, S**
(Function Key on pages 212-213)

DIMENSIONS

| | | | |
|-------------|-----|-----------------------|----------|
| Depth: | 25⅝ | Back Height: | 28 |
| Width: | 30¼ | Seat to Floor Height: | 18¾-23¾ |
| Height: | 43⅝ | Usable Seat Depth: | 18¾ |
| Seat Depth: | 18¾ | Ship Weight: | 59 |
| Seat Width: | 21⅝ | Cube: | 6.1 |
| Back Width: | 22¾ | Weight Rating: | 450 lbs. |

PRICE CODE

Mesh **\$901**

NOTES: Large scale model HVL705 will support up to 450 lbs with normal use. Available in Black Mesh fabric VM10. **HON 5-Year Limited Warranty.**

HON Recommendation: HVL705.VM10 - List Price \$901

HVL712



SIN 33721

MID-BACK

Pneumatic
Swivel
Synchro-tilt
Tilt Tension
Tilt Lock
Height-adjustable Arms

Functions: **A, E, J, K, L, Q**
(Function Key on pages 212-213)

DIMENSIONS

| | | | |
|--------------|-----|-----------------------|----------|
| Depth: | 28½ | Arm Width: | 18⅝ |
| Width: | 29½ | Seat to Floor Height: | 18-22¼ |
| Height: | 41¾ | Usable Seat Depth: | 18 |
| Seat Depth: | 18½ | Ship Weight: | 39 |
| Seat Width: | 19¾ | Cube: | 5.4 |
| Back Width: | 20½ | Weight Rating: | 250 lbs. |
| Back Height: | 20¾ | | |

PRICE CODE

Sandwich Mesh **\$517**

NOTES: Black Sandwich Mesh seat and mesh back. **HON 5-Year Limited Warranty.**

HON Recommendation: HVL712.MM10 - List Price \$517

HOW TO SPECIFY

Select
Model Number

Select
Fabric

- SB11** Black Bonded Leather
Specify for model HVL701 only
- MM10** Black Sandwich Mesh Fabric
Specify for models HVL702 and HVL712 only
- VM10** Black Mesh Fabric
Specify for model HVL705 only

HVL701.

SB11

WEST HILL™ CASUAL LOUNGE SEATING

Want to see more? Scan here
to check out hon.com.



West Hill™ Casual Lounge Seating
shown with Scramble™ Coffee Table.

WEST HILL™

Whether you're a thought leader, innovator, or highly-motivated team player, West Hill casual lounge creates an inviting space that inspires relaxed productivity, sustains concentration, and sparks creativity.

With solid construction, a multitude of back cushion styling, and seating options from a single seat to three or more, and choices in leg styles, fabrics, and configurations, West Hill makes it easier to make your space exceptional.



FEATURES

- Contoured seat cushion design brings living room comfort to the work space.
- Choose between a Square Back or sink into a comfy Pillow Back cushion.
- Semi-attached back and seat cushions make replacement easy.
- Square, welted back cushion creates a modern look while providing casual comfort.
- The multi-fabric option allows you to specify up to three fabrics on one model.
- Select one of two square metal leg options or hardwood cone feet in one of 10 finishes.
- Order an optional Throw Pillow to add a little extra comfort or a splash of color.
- Cushion packs available in both Standard and Pillow Back, apply to both side and back applications.
- Each seat is warranted for users up to 300 pounds.
- Pair with Scramble™ Occasional Tables to complete the modern aesthetic.

SEATING

WEST HILL™ Options

MODEL OPTIONS

HWH1SS, HWH1SP
HWH1SSCF, HWH1SPCF -
Multi-Fabric



Lounge
Single Seat

HWH2SS, HWH2SP
HWH2SSCF, HWH2SPCF -
Multi-Fabric

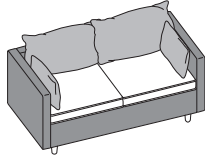

Lounge
Two-Seat

HWH3SS, HWH3SP
HWH3SSCF, HWH3SPCF -
Multi-Fabric

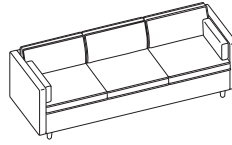

Lounge
Three-Seat

HWHITCS, HWHITCP
HWHITCSCF, HWHITPCPF -
Multi-Fabric

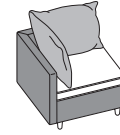

Lounge
True Corner

HWH1C
HWH1CCF - Multi-Fabric



Ottoman

HWHACPS, HWHACPP

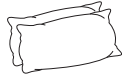

Arm Cushion Pack

HWHBCPS, HWHBCPP

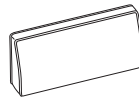

Back Cushion Pack

HWHLP, HWHSP18



**Lumbar and 18" Square
Throw Pillow**

Pillow Back Option, Multi-Fabric



Standard Back Option, Multi-Fabric

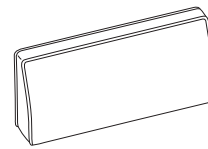
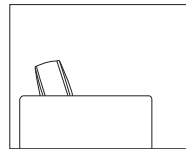
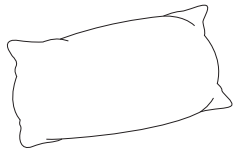
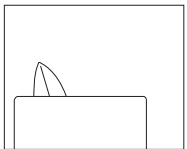

Choose from standard Single Fabric or Multi-Fabric options.
Specify up to three fabrics with the Multi-Fabric option.

HON BRANDED FABRICS

| GRADE 1 | GRADE 2 | GRADE 3 |
|------------|-----------------|-----------|
| Apex | Appoint Seating | In Season |
| Centurion | Blume | Moxie |
| Contourett | Clyde | Parker |
| Dapper | Dotty | Purl |
| Ensemble | Rush | Quill |
| Hamilton | Seed* | |
| Inertia* | Spin Seating | |
| Pebble | Whisper Vinyl* | |

For a complete list of fabrics, including partnership fabrics, go to hon.com/fabricsandfinishes.

Reference Fabric Color Combinations on pages 18-22 for color codes and legend on page 19 for lead times.

*Because of the differing upholstery process for the standard back and pillow back options, these fabrics are not available as an option for the pillow back. Contact your HON representative for questions.

i Due to the inherent characteristics of upholstery materials and the casual nature of West Hill™, fabric may relax to show wrinkles over time especially on the pillow back options.

| LEG STYLE | CODE | DESCRIPTION | PRICE | LEG STYLE | CODE | DESCRIPTION | PRICE |
|--|-------------|---|-------------|--|------------|---|--------------|
|  | CW | Cone Wood | +\$0 |  | SM | Square Metal | +\$50 |
| | | <i>Available in the following finishes:</i> | | | | <i>Available in the following finishes:</i> | |
| | LFW1 | Florence Walnut | | | P7A | Textured Charcoal | |
| | LK11 | Kingswood Walnut | | | P8V | Textured Titanium | |
| | LLA1 | Lowell Ash | | | | | |
| | D | Natural Maple | | | | | |
| | LN1 | Natural Recon | | | | | |
| | LPE1 | Phantom Ecru | | | | | |
| | PINC | Pinnacle | | | | | |
| | LPT1 | Portico Teak | | | | | |
| | LSW1 | Skyline Walnut | | | | | |
| | LSA1 | Sterling Ash | | | | | |

MULTI-FABRIC COM YARDAGE

Due to fabric pattern nesting and potential reduction of fabric yield, some multi-fabric models may require more total yardage than standard models.

| MODEL | COM (ARMLESS) | | | COM (ONE ARM) | | | COM (BOTH ARMS) | | |
|-----------|---------------|-------|------|---------------|-------|------|-----------------|-------|------|
| | Seat | Frame | Back | Seat | Frame | Back | Seat | Frame | Back |
| HWH1SS | | — | | | — | | | 7.0 | |
| HWH1SSCF | — | — | — | — | — | — | 1.5 | 5.0 | 2.5 |
| HWH1SP | | — | | | — | | | 7.0 | |
| HWH1SPCF | — | — | — | — | — | — | 1.5 | 5.0 | 1.5 |
| HWH2SS | | 8.5 | | | 9.5 | | | 10.5 | |
| HWH2SSCF | 3.0 | 4.0 | 2.5 | 3.0 | 5.0 | 3.0 | 3.0 | 6.0 | 3.0 |
| HWH2SP | | 8.5 | | | 9.5 | | | 11.0 | |
| HWH2SPCF | 3.0 | 4.0 | 2.0 | 3.0 | 5.0 | 2.5 | 3.0 | 6.0 | 3.0 |
| HWH3SS | | 12.0 | | | 13.0 | | | 14.0 | |
| HWH3SSCF | 4.0 | 5.5 | 3.0 | 4.0 | 6.5 | 3.5 | 4.0 | 7.5 | 3.5 |
| HWH3SP | | 12.5 | | | 13.5 | | | 14.5 | |
| HWH3SPCF | 4.0 | 5.5 | 3.0 | 4.0 | 6.5 | 3.5 | 4.0 | 7.5 | 4.0 |
| HWH1C | | 3.0 | | | — | | | — | |
| HWH1CCF | 1.5 | 2.0 | — | — | — | — | — | — | — |
| HWH1TCS | | 6.0 | | | — | | | — | |
| HWH1TCSCF | 1.5 | 3.5 | 2.5 | — | — | — | — | — | — |
| HWH1TCP | | 7.0 | | | — | | | — | |
| HWH1TCPF | 1.5 | 3.5 | 2.0 | — | — | — | — | — | — |

WEST HILL™ Casual Lounge Seating

OPEN MARKET



Icon Legend on page 17

HWH1SS

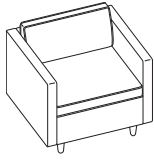

SINGLE SEAT LOUNGE — STANDARD CUSHION

DIMENSIONS

| | | | |
|-----------------------|-----|----------------|--------------|
| Depth: | 30½ | Back Height: | 12 |
| Height: | 29¾ | Back Width: | 26¾ |
| Width: | 33¾ | Arm Height: | 8 |
| Usable Seat Depth: | 19 | Ship Weight: | 81 |
| Seat to Floor Height: | 17¾ | Cube: | 18.4 |
| Seat Width: | 26¾ | COM: | See page 489 |
| | | Weight Rating: | 300 lbs. |

FABRIC PRICE CODES

| | | | |
|---|--------|----|--------|
| 1 | \$2291 | 8 | \$3559 |
| 2 | \$2459 | 9 | \$3591 |
| 3 | \$2630 | 10 | \$3762 |
| 4 | \$2772 | 11 | \$3934 |
| 5 | \$2963 | 12 | \$4105 |
| 6 | \$3157 | L | — |
| 7 | \$3356 | | |

HWH1SP

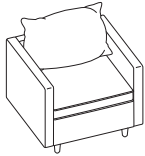

SINGLE SEAT LOUNGE — PILLOW CUSHION

DIMENSIONS

| | | | |
|-----------------------|-----|----------------|--------------|
| Depth: | 30½ | Back Height: | 13¾ |
| Height: | 31½ | Back Width: | 26¾ |
| Width: | 33¾ | Arm Height: | 8 |
| Usable Seat Depth: | 16½ | Ship Weight: | 81 |
| Seat to Floor Height: | 17¾ | Cube: | 18.4 |
| Seat Width: | 26¾ | COM: | See page 489 |
| | | Weight Rating: | 300 lbs. |

FABRIC PRICE CODES

| | | | |
|---|--------|----|--------|
| 1 | \$2291 | 8 | \$3559 |
| 2 | \$2459 | 9 | \$3591 |
| 3 | \$2630 | 10 | \$3762 |
| 4 | \$2772 | 11 | \$3934 |
| 5 | \$2963 | 12 | \$4105 |
| 6 | \$3157 | L | — |
| 7 | \$3356 | | |

HON Recommendation: HWH1SP.B.PURL__CW__ - List Price \$2630

SEATING

HOW TO SPECIFY

Select
Model Number

HWH1SP

Select
Arm Type

B Both Arms

B

Select
Fabric

See page 489

PBLE03

Select
Foot and Foot Color

SM Square Metal (+ \$50)

CW Cone Wood

See page 489 for colors

SMP8V



WEST HILL™ Casual Lounge Seating

HWH1SSCF

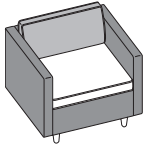

**SINGLE SEAT LOUNGE —
STANDARD CUSHION,
MULTI-FABRIC**

DIMENSIONS

| | | | |
|-----------------------|-----|----------------|--------------|
| Depth: | 30½ | Back Height: | 12 |
| Height: | 29¾ | Back Width: | 26¾ |
| Width: | 33¼ | Arm Height: | 8 |
| Usable Seat Depth: | 19 | Ship Weight: | 81 |
| Seat to Floor Height: | 17¾ | Cube: | 18.4 |
| Seat Width: | 26¾ | COM: | See page 489 |
| | | Weight Rating: | 300 lbs. |

FABRIC PRICE CODES

1 \$2467

Add to Base Price Above

| | Seat | Frame | Back |
|----|-------|--------|-------|
| 2 | \$36 | \$120 | \$36 |
| 3 | \$73 | \$242 | \$73 |
| 4 | \$103 | \$344 | \$103 |
| 5 | \$144 | \$480 | \$144 |
| 6 | \$186 | \$619 | \$186 |
| 7 | \$228 | \$761 | \$228 |
| 8 | \$272 | \$906 | \$272 |
| 9 | \$279 | \$929 | \$279 |
| 10 | \$315 | \$1051 | \$315 |
| 11 | \$352 | \$1173 | \$352 |
| 12 | \$389 | \$1296 | \$389 |

HWH1SPCF

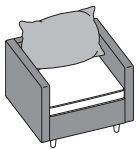

**SINGLE SEAT LOUNGE —
PILLOW CUSHION,
MULTI-FABRIC**

DIMENSIONS

| | | | |
|-----------------------|-----|----------------|--------------|
| Depth: | 30½ | Back Height: | 13¾ |
| Height: | 31½ | Back Width: | 26¾ |
| Width: | 33¼ | Arm Height: | 8 |
| Usable Seat Depth: | 16½ | Ship Weight: | 81 |
| Seat to Floor Height: | 17¾ | Cube: | 18.4 |
| Seat Width: | 26¾ | COM: | See page 489 |
| | | Weight Rating: | 300 lbs. |

FABRIC PRICE CODES

1 \$2467

Add to Base Price Above

| | Seat | Frame | Back |
|----|-------|--------|-------|
| 2 | \$36 | \$120 | \$36 |
| 3 | \$73 | \$242 | \$73 |
| 4 | \$103 | \$344 | \$103 |
| 5 | \$144 | \$480 | \$144 |
| 6 | \$186 | \$619 | \$186 |
| 7 | \$228 | \$761 | \$228 |
| 8 | \$272 | \$906 | \$272 |
| 9 | \$279 | \$929 | \$279 |
| 10 | \$315 | \$1051 | \$315 |
| 11 | \$352 | \$1173 | \$352 |
| 12 | \$389 | \$1296 | \$389 |

HON Recommendation: HWH1SPCF.B.PURL__PURL__PURL__CW__ - List Price \$2855

HOW TO SPECIFY

| | | | | | |
|--|--|---|--|---|---|
| <p>Select Model Number</p> <p>HWH1SPCF .</p> | <p>Select Arm Type</p> <p>B Both Arms</p> <p>B .</p> | <p>Select Seat Fabric</p> <p>See page 489</p> <p>PBLE07 .</p> | <p>Select Frame Fabric</p> <p>See page 489</p> <p>PBLE03 .</p> | <p>Select Back Fabric</p> <p>See page 489</p> <p>PBLE01 .</p> | <p>Select Foot and Foot Color</p> <p>SM Square Metal (+ \$50) CW Cone Wood See page 489 for colors</p> <p>SMP8V</p> |
|--|--|---|--|---|---|

WEST HILL™ Casual Lounge Seating

OPEN MARKET



Icon Legend on page 17

HWH2SS

TWO SEAT LOUNGE — STANDARD CUSHION

DIMENSIONS

FABRIC PRICE CODES

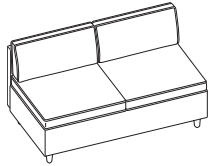

Armless

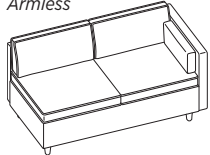

Left

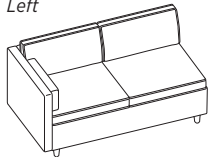

Right

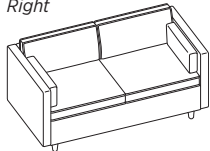

Both Arms

| | | | |
|-------------------------|-----|--------------------------|---------------------|
| Depth: | 30½ | Back Height: | 12 |
| Height: | 29¾ | Back Width: | 53¾ |
| Width (armless): | 53¾ | Arm Height: | 8 |
| Width (one arm): | 57 | Ship Weight (armless): | 107 |
| Width (both arms): | 60¼ | Ship Weight (one arm): | 121 |
| Usable Seat Depth: | 19 | Ship Weight (both arms): | 135 |
| Seat to Floor Height: | 17¾ | Cube: | 34.0 |
| Seat Width (armless): | 53¾ | COM: | See page 489 |
| Seat Width (one arm): | 49½ | Weight Rating: | 300 lbs. (per seat) |
| Seat Width (both arms): | 45¼ | | |

| | | | |
|----------|---------------|-----------|---------------|
| 1 | \$3114 | 8 | \$5017 |
| 2 | \$3365 | 9 | \$5064 |
| 3 | \$3623 | 10 | \$5321 |
| 4 | \$3836 | 11 | \$5578 |
| 5 | \$4122 | 12 | \$5835 |
| 6 | \$4414 | L | — |
| 7 | \$4712 | | |

NOTES: Includes semi-attached arm cushions as shown.

HWH2SP

TWO SEAT LOUNGE — PILLOW CUSHION

DIMENSIONS

FABRIC PRICE CODES



Armless



Left

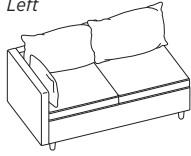

Right

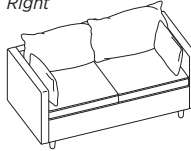

Both Arms

| | | | |
|-------------------------|-----|--------------------------|---------------------|
| Depth: | 30½ | Back Height: | 13¾ |
| Height: | 29¾ | Back Width: | 53¾ |
| Width (armless): | 53¾ | Arm Height: | 8 |
| Width (one arm): | 57 | Ship Weight (armless): | 107 |
| Width (both arms): | 60¼ | Ship Weight (one arm): | 121 |
| Usable Seat Depth: | 16½ | Ship Weight (both arms): | 135 |
| Seat to Floor Height: | 17¾ | Cube: | 34.0 |
| Seat Width (armless): | 53¾ | COM: | See page 489 |
| Seat Width (one arm): | 48½ | Weight Rating: | 300 lbs. (per seat) |
| Seat Width (both arms): | 43¼ | | |

| | | | |
|----------|---------------|-----------|---------------|
| 1 | \$3114 | 8 | \$5107 |
| 2 | \$3377 | 9 | \$5157 |
| 3 | \$3647 | 10 | \$5426 |
| 4 | \$3870 | 11 | \$5696 |
| 5 | \$4170 | 12 | \$5965 |
| 6 | \$4475 | L | — |
| 7 | \$4788 | | |

NOTES: Includes semi-attached arm cushions as shown.

HON Recommendation: HWH2SP.B.PURL__CW__ - List Price \$3997

HOW TO SPECIFY

| | | | |
|---|--|---|--|
| <p>Select Model Number</p> <p>HWH2SP</p> | <p>Select Arm Type</p> <p>N No Arms L Left Arm Only (+ \$175) R Right Arm Only (+ \$175) B Both Arms (+ \$350)</p> <p>B</p> | <p>Select Fabric</p> <p>See page 489</p> <p>PBLE03</p> | <p>Select Foot and Foot Color</p> <p>SM Square Metal (+ \$50) CW Cone Wood See page 489 for colors</p> <p>SMP8V</p> |
|---|--|---|--|



WEST HILL™ Casual Lounge Seating

HWH2SSCF

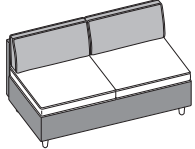

Armless

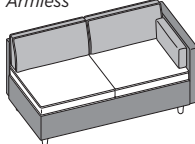

Left

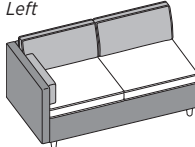

Right

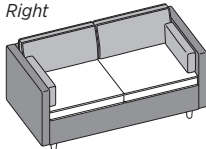

Both Arms

TWO SEAT LOUNGE — STANDARD CUSHION, MULTI-FABRIC

DIMENSIONS

| | | | |
|-------------------------|-----|--------------------------|---------------------|
| Depth: | 30½ | Back Height: | 12 |
| Height: | 29¾ | Back Width: | 53¾ |
| Width (armless): | 53¾ | Arm Height: | 8 |
| Width (one arm): | 57 | Ship Weight (armless): | 107 |
| Width (both arms): | 60¼ | Ship Weight (one arm): | 121 |
| Usable Seat Depth: | 19 | Ship Weight (both arms): | 135 |
| Seat to Floor Height: | 17¾ | Cube: | 34.0 |
| Seat Width (armless): | 53¾ | COM: | See page 489 |
| Seat Width (one arm): | 49½ | Weight Rating: | 300 lbs. (per seat) |
| Seat Width (both arms): | 45¼ | | |

FABRIC PRICE CODES

| | | | |
|--------------------------------|---------------|---------------|--------------|
| 1 | \$3290 | | |
| <i>Add to Base Price Above</i> | | | |
| | Seat | Frame | Back |
| 2 | \$72 | \$144 | \$72 |
| 3 | \$145 | \$291 | \$145 |
| 4 | \$206 | \$412 | \$206 |
| 5 | \$288 | \$576 | \$288 |
| 6 | \$371 | \$743 | \$371 |
| 7 | \$457 | \$913 | \$457 |
| 8 | \$544 | \$1087 | \$544 |
| 9 | \$557 | \$1114 | \$557 |
| 10 | \$631 | \$1261 | \$631 |
| 11 | \$704 | \$1408 | \$704 |
| 12 | \$778 | \$1555 | \$778 |

NOTES: Includes semi-attached arm cushions as shown.

HWH2SPCF

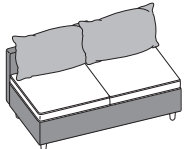

Armless

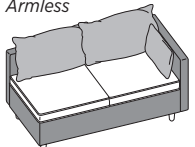

Left

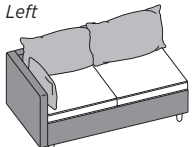

Right

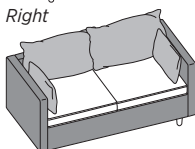

Both Arms

TWO SEAT LOUNGE — PILLOW CUSHION, MULTI-FABRIC

DIMENSIONS

| | | | |
|-------------------------|-----|--------------------------|---------------------|
| Depth: | 30½ | Back Height: | 13¾ |
| Height: | 29¾ | Back Width: | 53¾ |
| Width (armless): | 53¾ | Arm Height: | 8 |
| Width (one arm): | 57 | Ship Weight (armless): | 107 |
| Width (both arms): | 60¼ | Ship Weight (one arm): | 121 |
| Usable Seat Depth: | 16½ | Ship Weight (both arms): | 135 |
| Seat to Floor Height: | 17¾ | Cube: | 34.0 |
| Seat Width (armless): | 53¾ | COM: | See page 489 |
| Seat Width (one arm): | 48½ | Weight Rating: | 300 lbs. (per seat) |
| Seat Width (both arms): | 43¼ | | |

FABRIC PRICE CODES

| | | | |
|--------------------------------|---------------|---------------|--------------|
| 1 | \$3290 | | |
| <i>Add to Base Price Above</i> | | | |
| | Seat | Frame | Back |
| 2 | \$72 | \$144 | \$72 |
| 3 | \$145 | \$291 | \$145 |
| 4 | \$206 | \$412 | \$206 |
| 5 | \$288 | \$576 | \$288 |
| 6 | \$371 | \$743 | \$371 |
| 7 | \$457 | \$913 | \$457 |
| 8 | \$544 | \$1087 | \$544 |
| 9 | \$557 | \$1114 | \$557 |
| 10 | \$631 | \$1261 | \$631 |
| 11 | \$704 | \$1408 | \$704 |
| 12 | \$778 | \$1555 | \$778 |

NOTES: Includes semi-attached arm cushions as shown.

HON Recommendation: HWH2SPCF.B.PURL__PURL__PURL__CW__ - List Price \$4221

HOW TO SPECIFY

| | | | | | |
|--|---|---|--|---|--|
| Select Model Number HWH2SPCF | Select Arm Type N No Arms L Left Arm Only (+ \$175) R Right Arm Only (+ \$175) B Both Arms (+ \$350) | Select Seat Fabric See page 489 | Select Frame Fabric See page 489 | Select Back Fabric See page 489 | Select Foot and Foot Color SM Square Metal (+ \$50) CW Cone Wood See page 489 for colors |
| HWH2SPCF | B | PBLE07 | PBLE03 | PBLE01 | SMP8V |

SEATING

WEST HILL™ Casual Lounge Seating

OPEN MARKET



Icon Legend on page 17

HWH3SS

THREE SEAT LOUNGE — STANDARD CUSHION

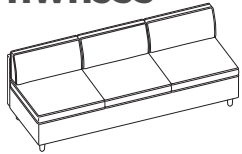

Armless

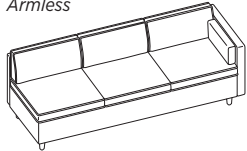

Left

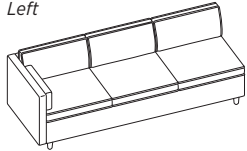

Right

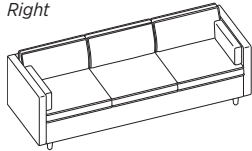

Both Arms

DIMENSIONS

| | | | |
|-------------------------|-----|--------------------------|---------------------|
| Depth: | 30½ | Back Height: | 12 |
| Height: | 29¾ | Back Width: | 80¾ |
| Width (armless): | 80¾ | Arm Height: | 8 |
| Width (one arm): | 84 | Ship Weight (armless): | 146 |
| Width (both arms): | 87¼ | Ship Weight (one arm): | 160 |
| Usable Seat Depth: | 19 | Ship Weight (both arms): | 174 |
| Seat to Floor Height: | 17¾ | Cube: | 46.5 |
| Seat Width (armless): | 80¾ | COM: | See page 489 |
| Seat Width (one arm): | 76½ | Weight Rating: | 300 lbs. (per seat) |
| Seat Width (both arms): | 72¼ | | |

FABRIC PRICE CODES

| | | | |
|---|--------|----|--------|
| 1 | \$4230 | 8 | \$6767 |
| 2 | \$4565 | 9 | \$6830 |
| 3 | \$4909 | 10 | \$7173 |
| 4 | \$5192 | 11 | \$7516 |
| 5 | \$5573 | 12 | \$7858 |
| 6 | \$5963 | L | — |
| 7 | \$6360 | | |

NOTES: Includes semi-attached arm cushions as shown.

HWH3SP

THREE SEAT LOUNGE — PILLOW CUSHION

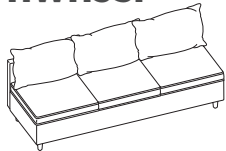

Armless

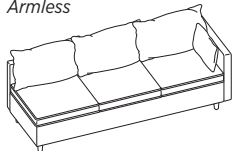

Left

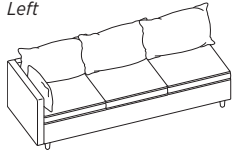

Right

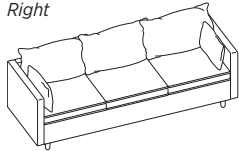

Both Arms

DIMENSIONS

| | | | |
|-------------------------|-----|--------------------------|---------------------|
| Depth: | 30½ | Back Height: | 13¾ |
| Height: | 31½ | Back Width: | 80¾ |
| Width (armless): | 80¾ | Arm Height: | 8 |
| Width (one arm): | 84 | Ship Weight (armless): | 146 |
| Width (both arms): | 87¼ | Ship Weight (one arm): | 160 |
| Usable Seat Depth: | 16½ | Ship Weight (both arms): | 174 |
| Seat to Floor Height: | 17¾ | Cube: | 46.5 |
| Seat Width (armless): | 80¾ | COM: | See page 489 |
| Seat Width (one arm): | 75½ | Weight Rating: | 300 lbs. (per seat) |
| Seat Width (both arms): | 70¼ | | |

FABRIC PRICE CODES

| | | | |
|---|--------|----|--------|
| 1 | \$4230 | 8 | \$6857 |
| 2 | \$4577 | 9 | \$6923 |
| 3 | \$4933 | 10 | \$7278 |
| 4 | \$5227 | 11 | \$7633 |
| 5 | \$5621 | 12 | \$7988 |
| 6 | \$6025 | L | — |
| 7 | \$6436 | | |

NOTES: Includes semi-attached arm cushions as shown.

HON Recommendation: HWH3SP.B.PURL__CW__ - List Price \$5283

HOW TO SPECIFY

| | | | |
|---|--|---|---|
| <p>Select Model Number</p> <p>HWH3SP</p> | <p>Select Arm Type</p> <p>N No Arms L Left Arm Only (+ \$175) R Right Arm Only (+ \$175) B Both Arms (+ \$350)</p> <p>B</p> | <p>Select Fabric</p> <p>See page 489</p> <p>PBLE03</p> | <p>Select Foot and Foot Color</p> <p>SM Square Metal (+ \$50) CW Cone Wood</p> <p>See page 489 for colors</p> <p>SMP8V</p> |
|---|--|---|---|



WEST HILL™ Casual Lounge Seating

HWH3SSCF

THREE SEAT LOUNGE — STANDARD CUSHION, MULTI-FABRIC

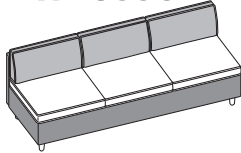

Armless

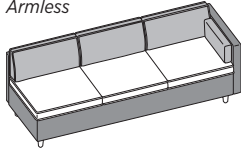

Left

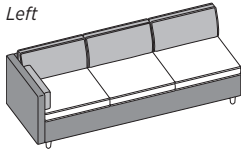

Right

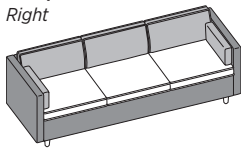

Both Arms

DIMENSIONS

| | | | |
|-------------------------|-----|--------------------------|---------------------|
| Depth: | 30½ | Back Height: | 12 |
| Height: | 29¾ | Back Width: | 80¾ |
| Width (armless): | 80¾ | Arm Height: | 8 |
| Width (one arm): | 84 | Ship Weight (armless): | 146 |
| Width (both arms): | 87¼ | Ship Weight (one arm): | 160 |
| Usable Seat Depth: | 19 | Ship Weight (both arms): | 174 |
| Seat to Floor Height: | 17¾ | Cube: | 46.5 |
| Seat Width (armless): | 80¾ | COM: | See page 489 |
| Seat Width (one arm): | 76½ | Weight Rating: | 300 lbs. (per seat) |
| Seat Width (both arms): | 72¼ | | |

FABRIC PRICE CODES

| | | | |
|--------------------------------|---------------|---------------|--------------|
| 1 | \$4406 | | |
| <i>Add to Base Price Above</i> | | | |
| | Seat | Frame | Back |
| 2 | \$96 | \$180 | \$84 |
| 3 | \$194 | \$364 | \$170 |
| 4 | \$275 | \$516 | \$241 |
| 5 | \$384 | \$720 | \$336 |
| 6 | \$495 | \$928 | \$433 |
| 7 | \$609 | \$1141 | \$533 |
| 8 | \$725 | \$1359 | \$634 |
| 9 | \$743 | \$1393 | \$650 |
| 10 | \$841 | \$1576 | \$736 |
| 11 | \$939 | \$1760 | \$821 |
| 12 | \$1037 | \$1944 | \$907 |

NOTES: Includes semi-attached arm cushions as shown.

HWH3SPCF

THREE SEAT LOUNGE — PILLOW CUSHION, MULTI-FABRIC

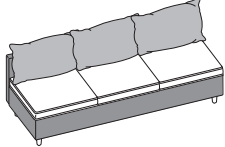

Armless

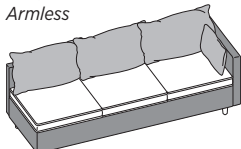

Left

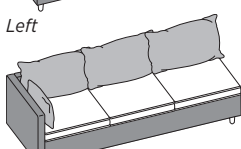

Right

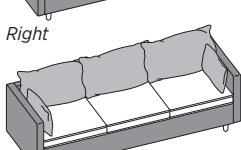

Both Arms

DIMENSIONS

| | | | |
|-------------------------|-----|--------------------------|---------------------|
| Depth: | 30½ | Back Height: | 13¾ |
| Height: | 31½ | Back Width: | 80¾ |
| Width (armless): | 80¾ | Arm Height: | 8 |
| Width (one arm): | 84 | Ship Weight (armless): | 146 |
| Width (both arms): | 87¼ | Ship Weight (one arm): | 160 |
| Usable Seat Depth: | 16½ | Ship Weight (both arms): | 174 |
| Seat to Floor Height: | 17¾ | Cube: | 46.5 |
| Seat Width (armless): | 80¾ | COM: | See page 489 |
| Seat Width (one arm): | 75½ | Weight Rating: | 300 lbs. (per seat) |
| Seat Width (both arms): | 70¼ | | |

FABRIC PRICE CODES

| | | | |
|--------------------------------|---------------|---------------|---------------|
| 1 | \$4406 | | |
| <i>Add to Base Price Above</i> | | | |
| | Seat | Frame | Back |
| 2 | \$96 | \$180 | \$96 |
| 3 | \$194 | \$364 | \$194 |
| 4 | \$275 | \$516 | \$275 |
| 5 | \$384 | \$720 | \$384 |
| 6 | \$495 | \$928 | \$495 |
| 7 | \$609 | \$1141 | \$609 |
| 8 | \$725 | \$1359 | \$725 |
| 9 | \$743 | \$1393 | \$743 |
| 10 | \$841 | \$1576 | \$841 |
| 11 | \$939 | \$1760 | \$939 |
| 12 | \$1037 | \$1944 | \$1037 |

NOTES: Includes semi-attached arm cushions as shown.

HON Recommendation: HWH3SPCF.B.PURL__PURL__PURL__CW__ - List Price \$5508

HOW TO SPECIFY

| | | | | | |
|---|--|--|---|--|--|
| <p>Select Model Number</p> <p>HWH3SPCF</p> | <p>Select Arm Type</p> <p>N No Arms L Left Arm Only (+ \$175) R Right Arm Only (+ \$175) B Both Arms (+ \$350)</p> <p>B</p> | <p>Select Seat Fabric</p> <p>See page 489</p> <p>PBLE07</p> | <p>Select Frame Fabric</p> <p>See page 489</p> <p>PBLE03</p> | <p>Select Back Fabric</p> <p>See page 489</p> <p>PBLE01</p> | <p>Select Foot and Foot Color</p> <p>SM Square Metal (+ \$50) CW Cone Wood See page 489 for colors</p> <p>SMP8V</p> |
|---|--|--|---|--|--|

WEST HILL™ Ottomans

OPEN MARKET



Icon Legend on page 17

HWH1C

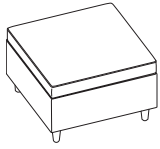

OTTOMAN

DIMENSIONS

| | | | |
|-----------------------|-----|----------------|--------------|
| Depth: | 27¼ | Ship Weight: | 47 |
| Height: | 17¾ | Cube: | 18.4 |
| Width: | 27¼ | COM: | See page 489 |
| Usable Seat Depth: | 27¼ | Weight Rating: | 300 lbs. |
| Seat to Floor Height: | 17¾ | | |
| Seat Width: | 27¼ | | |

FABRIC PRICE CODES

| | | | |
|---|--------|----|--------|
| 1 | \$1352 | 8 | \$1896 |
| 2 | \$1424 | 9 | \$1909 |
| 3 | \$1497 | 10 | \$1983 |
| 4 | \$1558 | 11 | \$2056 |
| 5 | \$1640 | 12 | \$2130 |
| 6 | \$1723 | L | — |
| 7 | \$1809 | | |

HWH1CCF

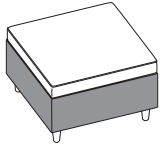

OTTOMAN, MULTI-FABRIC

DIMENSIONS

| | | | |
|-----------------------|-----|----------------|--------------|
| Depth: | 27¼ | Ship Weight: | 47 |
| Height: | 17¾ | Cube: | 18.4 |
| Width: | 27¼ | COM: | See page 489 |
| Usable Seat Depth: | 27¼ | Weight Rating: | 300 lbs. |
| Seat to Floor Height: | 17¾ | | |
| Seat Width: | 27¼ | | |

FABRIC PRICE CODES

| | | |
|--------------------------------|--------|-------|
| 1 | \$1528 | |
| <i>Add to Base Price Above</i> | | |
| | Seat | Frame |
| 2 | \$36 | \$36 |
| 3 | \$73 | \$73 |
| 4 | \$103 | \$103 |
| 5 | \$144 | \$144 |
| 6 | \$186 | \$186 |
| 7 | \$228 | \$228 |
| 8 | \$272 | \$272 |
| 9 | \$279 | \$279 |
| 10 | \$315 | \$315 |
| 11 | \$352 | \$352 |
| 12 | \$389 | \$389 |

HON Recommendation: HWH1C.PURL___.CW__ - List Price \$1497

SEATING

HOW TO SPECIFY

Select
Model Number

HWH1CCF .

Select
Fabric

See page 489

PBLE03 .

Select
Seat Fabric

*Specify for model HWH1CCF
only*

PBLE03 .

Select
Frame Fabric

*Specify for model HWH1CCF
only*

PBLE07 .

Select
Foot and Foot Color

SM Square Metal (+ \$50)
CW Cone Wood
See page 489 for colors

SMP8V



WEST HILL™ Casual Lounge Seating

HWH1TCS

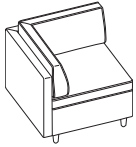

TRUE CORNER — STANDARD CUSHION

DIMENSIONS

| | | | |
|-----------------------|-----|----------------|--------------|
| Depth: | 30½ | Ship Weight: | 73 |
| Height: | 29¾ | Cube: | 18.4 |
| Width: | 30½ | COM: | See page 489 |
| Usable Seat Depth: | 19 | Weight Rating: | 300 lbs. |
| Seat to Floor Height: | 17¾ | | |
| Back Height: | 12 | | |

FABRIC PRICE CODES

| | | | |
|---|--------|----|--------|
| 1 | \$2291 | 8 | \$3378 |
| 2 | \$2435 | 9 | \$3405 |
| 3 | \$2582 | 10 | \$3552 |
| 4 | \$2703 | 11 | \$3699 |
| 5 | \$2867 | 12 | \$3846 |
| 6 | \$3034 | L | — |
| 7 | \$3204 | | |

HWH1TCP

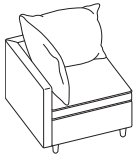

TRUE CORNER — PILLOW CUSHION

DIMENSIONS

| | | | |
|-----------------------|-----|----------------|--------------|
| Depth: | 30½ | Ship Weight: | 73 |
| Height: | 31½ | Cube: | 18.4 |
| Width: | 30½ | COM: | See page 489 |
| Usable Seat Depth: | 16½ | Weight Rating: | 300 lbs. |
| Seat to Floor Height: | 17¾ | | |
| Back Height: | 13¾ | | |

FABRIC PRICE CODES

| | | | |
|---|--------|----|--------|
| 1 | \$2291 | 8 | \$3559 |
| 2 | \$2459 | 9 | \$3591 |
| 3 | \$2630 | 10 | \$3762 |
| 4 | \$2772 | 11 | \$3934 |
| 5 | \$2963 | 12 | \$4105 |
| 6 | \$3157 | L | — |
| 7 | \$3356 | | |

HON Recommendation: HWH1TCP.PURL__CW__ - List Price \$2582

HOW TO SPECIFY

| | | |
|--|---|---|
| <p>Select Model Number</p> <p>HWH1TCP</p> | <p>Select Fabric</p> <p>See page 489</p> <p>PBLE03</p> | <p>Select Foot and Foot Color</p> <p>SM Square Metal (+ \$50) CW Cone Wood</p> <p>See page 489 for colors</p> <p>SMP8V</p> |
|--|---|---|

SEATING

WEST HILL™ Casual Lounge Seating

OPEN MARKET



Icon Legend on page 17

HWH1TCSCF

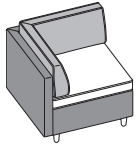

**TRUE CORNER —
STANDARD CUSHION,
MULTI-FABRIC**

DIMENSIONS

| | | | |
|-----------------------|-----|----------------|--------------|
| Depth: | 30½ | Ship Weight: | 73 |
| Height: | 29¾ | Cube: | 18.4 |
| Width: | 30½ | COM: | See page 489 |
| Usable Seat Depth: | 19 | Weight Rating: | 300 lbs. |
| Seat to Floor Height: | 17¾ | | |
| Back Height: | 12 | | |

FABRIC PRICE CODES

1 \$2467

Add to Base Price Above

| | Seat | Frame | Back |
|----|-------|-------|-------|
| 2 | \$36 | \$84 | \$60 |
| 3 | \$73 | \$170 | \$121 |
| 4 | \$103 | \$241 | \$172 |
| 5 | \$144 | \$336 | \$240 |
| 6 | \$186 | \$433 | \$309 |
| 7 | \$228 | \$533 | \$380 |
| 8 | \$272 | \$634 | \$453 |
| 9 | \$279 | \$650 | \$464 |
| 10 | \$315 | \$736 | \$525 |
| 11 | \$352 | \$821 | \$587 |
| 12 | \$389 | \$907 | \$648 |

HWH1TCPCF



**TRUE CORNER —
PILLOW CUSHION,
MULTI-FABRIC**

DIMENSIONS

| | | | |
|-----------------------|-----|----------------|--------------|
| Depth: | 30½ | Ship Weight: | 73 |
| Height: | 31½ | Cube: | 18.4 |
| Width: | 30½ | COM: | See page 489 |
| Usable Seat Depth: | 16½ | Weight Rating: | 300 lbs. |
| Seat to Floor Height: | 17¾ | | |
| Back Height: | 13¾ | | |

FABRIC PRICE CODES

1 \$2467

Add to Base Price Above

| | Seat | Frame | Back |
|----|-------|-------|-------|
| 2 | \$36 | \$84 | \$48 |
| 3 | \$73 | \$170 | \$97 |
| 4 | \$103 | \$241 | \$137 |
| 5 | \$144 | \$336 | \$192 |
| 6 | \$186 | \$433 | \$248 |
| 7 | \$228 | \$533 | \$304 |
| 8 | \$272 | \$634 | \$362 |
| 9 | \$279 | \$650 | \$371 |
| 10 | \$315 | \$736 | \$420 |
| 11 | \$352 | \$821 | \$469 |
| 12 | \$389 | \$907 | \$518 |

HON Recommendation: HWH1TCPCF.PURL__PURL__PURL__CW__ - List Price \$2807

HOW TO SPECIFY

Select
Model Number

HWH1TCPCF .

Select
Seat Fabric

See page 489

PBLE07 .

Select
Frame Fabric

See page 489

PBLE03 .

Select
Back Fabric

See page 489

PBLE01 .

Select
Foot and Foot Color

SM Square Metal (+ \$50)

CW Cone Wood

See page 489 for colors

SMP8V



THROW PILLOWS

HWHLP



LUMBAR THROW PILLOW

DIMENSIONS

| | |
|--------------|-----|
| Height: | 10 |
| Width: | 18 |
| COM: | 1.0 |
| Ship Weight: | 2.5 |
| Cube: | 2.3 |

FABRIC PRICE CODES

| | | | |
|---|-------|----|-------|
| 1 | \$159 | 8 | \$340 |
| 2 | \$183 | 9 | \$345 |
| 3 | \$207 | 10 | \$369 |
| 4 | \$228 | 11 | \$394 |
| 5 | \$255 | 12 | \$418 |
| 6 | \$283 | L | — |
| 7 | \$311 | | |

HWHSP18



18" SQUARE THROW PILLOW

DIMENSIONS

| | |
|--------------|-----|
| Height: | 18 |
| Width: | 18 |
| COM: | 1.0 |
| Ship Weight: | 3.0 |
| Cube: | 2.3 |

FABRIC PRICE CODES

| | | | |
|---|-------|----|-------|
| 1 | \$196 | 8 | \$377 |
| 2 | \$220 | 9 | \$382 |
| 3 | \$244 | 10 | \$406 |
| 4 | \$265 | 11 | \$431 |
| 5 | \$292 | 12 | \$455 |
| 6 | \$320 | L | — |
| 7 | \$348 | | |

HOW TO SPECIFY

| | |
|---|--|
| <p>Select Model Number</p> <p>HWHSP18</p> | <p>Select Fabric</p> <p>See page 489</p> <p>PBLE03</p> |
|---|--|



HWHACPS

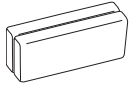

ARM CUSHION PACK — STANDARD

DIMENSIONS

COM: 1.0
Ship Weight: 4.1
Cube: 3.9

FABRIC PRICE CODES

| | | | |
|---|-------|----|-------|
| 1 | \$236 | 8 | \$417 |
| 2 | \$260 | 9 | \$422 |
| 3 | \$284 | 10 | \$446 |
| 4 | \$305 | 11 | \$471 |
| 5 | \$332 | 12 | \$495 |
| 6 | \$360 | L | — |
| 7 | \$388 | | |

NOTES: Includes both L and R Arm Cushions.

ⓘ Cushion arm cushions can be replaced or switched out with these cushion packs.

HWHACPP



ARM CUSHION PACK — PILLOW

DIMENSIONS

COM: 1.0
Ship Weight: 5.7
Cube: 3.9

FABRIC PRICE CODES

| | | | |
|---|-------|----|-------|
| 1 | \$236 | 8 | \$417 |
| 2 | \$260 | 9 | \$422 |
| 3 | \$284 | 10 | \$446 |
| 4 | \$305 | 11 | \$471 |
| 5 | \$332 | 12 | \$495 |
| 6 | \$360 | L | — |
| 7 | \$388 | | |

NOTES: Includes both L and R Arm Cushions.

ⓘ Cushion arm cushions can be replaced or switched out with these cushion packs.

HWHBCPS

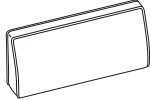

BACK CUSHION PACK — STANDARD

DIMENSIONS

COM: 2.5
Ship Weight: 8.1
Cube: 3.9

FABRIC PRICE CODES

| | | | |
|---|-------|----|-------|
| 1 | \$236 | 8 | \$689 |
| 2 | \$296 | 9 | \$700 |
| 3 | \$357 | 10 | \$761 |
| 4 | \$408 | 11 | \$823 |
| 5 | \$476 | 12 | \$884 |
| 6 | \$545 | L | — |
| 7 | \$616 | | |

NOTES: Includes a single Standard Back Cushion.

ⓘ Cushion backs can be replaced or switched out with these cushion packs.

HWHBCPP

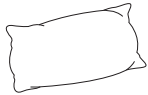

BACK CUSHION PACK — PILLOW

DIMENSIONS

COM: 1.5
Ship Weight: 8.1
Cube: 3.9

FABRIC PRICE CODES

| | | | |
|---|-------|----|-------|
| 1 | \$236 | 8 | \$508 |
| 2 | \$272 | 9 | \$515 |
| 3 | \$309 | 10 | \$551 |
| 4 | \$339 | 11 | \$588 |
| 5 | \$380 | 12 | \$625 |
| 6 | \$422 | L | — |
| 7 | \$464 | | |

NOTES: Includes a single Pillow Back Cushion.

ⓘ Cushion backs can be replaced or switched out with these cushion packs.

HWHGB

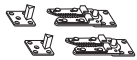

GANGING BRACKET

DIMENSIONS

Ship Weight: 1.0
Cube: 0.1

LIST PRICE

\$60

SPECIFYING EXAMPLE: HWHGB

HOW TO SPECIFY

| | |
|---|--|
| <p>Select Model Number</p> <p>HWHBCPP</p> | <p>Select Fabric</p> <p>See page 489</p> <p>PBLE03</p> |
|---|--|



EXECUTIVE CHAIRS

HVL105



HIGH-BACK

Pneumatic
Swivel
Tilt
Tilt Tension
Tilt Lock
Fixed Padded Arms

Functions: **A, E, F, K, L**
(Function Key on pages 212-213)

DIMENSIONS

| | | | |
|--------------|-----|-----------------------|----------|
| Depth: | 27½ | Arm Width: | 19 |
| Width: | 25 | Seat to Floor Height: | 17½-20¼ |
| Height: | 45¾ | Usable Seat Depth: | 20¼ |
| Seat Depth: | 20¼ | Ship Weight: | 46.0 |
| Seat Width: | 19½ | Cube: | 6.6 |
| Back Width: | 20½ | Weight Rating: | 250 lbs. |
| Back Height: | 28¾ | | |

PRICE CODE

Leather **\$594**

NOTES: Black Bonded Leather. Polished base. Fixed, padded arms. **HON 5-Year Limited Warranty.**

HON Recommendation: HVL105.SB11 - List Price \$594

HVL131



HIGH-BACK

Pneumatic
Swivel
Tilt
Tilt Tension
Tilt Lock
Fixed Padded Loop Arms

Functions: **A, E, F, K, L, T**
(Function Key on pages 212-213)

DIMENSIONS

| | | | |
|--------------|-----|-----------------------|----------|
| Depth: | 40 | Arm Width: | 20½ |
| Width: | 28½ | Seat to Floor Height: | 18½-22 |
| Height: | 45½ | Usable Seat Depth: | 18¼ |
| Seat Depth: | 18¼ | Ship Weight: | 42 |
| Seat Width: | 20¾ | Cube: | 6.3 |
| Back Width: | 20¾ | Weight Rating: | 250 lbs. |
| Back Height: | 26⅞ | | |

PRICE CODE

Vinyl **\$500**

NOTES: Black vinyl with contrasting top stitch. Black frame. Padded loop arms. **HON 5-Year Limited Warranty.**

HON Recommendation: HVL131.EN11 - List Price \$500

HVL151



HIGH-BACK

Pneumatic
Swivel
Tilt
Tilt Tension
Tilt Lock
Fixed Padded Loop Arms

Functions: **A, E, F, K, L, T**
(Function Key on pages 212-213)

DIMENSIONS

| | | | |
|--------------|-----|-----------------------|----------|
| Depth: | 37½ | Arm Width: | 20½ |
| Width: | 27 | Seat to Floor Height: | 17¾-21½ |
| Height: | 45½ | Usable Seat Depth: | 18⅝ |
| Seat Depth: | 18⅝ | Ship Weight: | 38 |
| Seat Width: | 20½ | Cube: | 5.1 |
| Back Width: | 20½ | Weight Rating: | 250 lbs. |
| Back Height: | 27¼ | | |

PRICE CODE

Leather **\$431**

NOTES: Black Bonded Leather. Black frame. Padded loop arms. **HON 5-Year Limited Warranty.**

HON Recommendation: HVL151.SB11 - List Price \$431

HOW TO SPECIFY

Select
Model Number

Select
Fabric

- SB11** Black Bonded Leather
Specify for models HVL105 and HVL151 only
- EN11** Black Vinyl
Specify for model HVL131 only

H V L 1 0 5 .

S B 1 1



Icon Legend on page 17

EXECUTIVE CHAIRS

HVL161



HIGH-BACK

Pneumatic
Swivel
Tilt
Tilt Tension
Tilt Lock
Fixed Padded Loop Arms

Functions: **A, E, F, K, L, T**
(Function Key on pages 212-213)

DIMENSIONS

| | | | |
|--------------|-----|-----------------------|----------|
| Depth: | 39¼ | Arm Width: | 19 |
| Width: | 25½ | Seat to Floor Height: | 18¾-22½ |
| Height: | 45 | Usable Seat Depth: | 18¾ |
| Seat Depth: | 18¾ | Ship Weight: | 35 |
| Seat Width: | 19 | Cube: | 4.8 |
| Back Width: | 19 | Weight Rating: | 250 lbs. |
| Back Height: | 26¾ | | |

PRICE CODE

Leather **\$405**

NOTES: Black Bonded Leather. Black frame. Padded loop arms. **HON 5-Year Limited Warranty.**

HON Recommendation: HVL161.SB11 - List Price \$405

HVL171



MID-BACK

Pneumatic
Swivel
Tilt
Tilt Tension
Tilt Lock
Fixed Loop Arms

Functions: **A, E, F, K, L, T**
(Function Key on pages 212-213)

DIMENSIONS

| | | | |
|--------------|-----|-----------------------|----------|
| Depth: | 34½ | Arm Width: | 19¾ |
| Width: | 25¾ | Seat to Floor Height: | 16¾-20½ |
| Height: | 38¾ | Usable Seat Depth: | 17¾ |
| Seat Depth: | 17¾ | Ship Weight: | 26 |
| Seat Width: | 19¾ | Cube: | 3.9 |
| Back Width: | 18¾ | Weight Rating: | 250 lbs. |
| Back Height: | 21¾ | | |

PRICE CODE

Leather **\$330**

NOTES: Black Bonded Leather. Black frame. Loop arms. **HON 5-Year Limited Warranty.**

HON Recommendation: HVL171.SB11 - List Price \$330

HVL402



HIGH-BACK

Pneumatic
Swivel
Tilt
Tilt Tension
Tilt Lock
Fixed Padded Loop Arms

Functions: **A, E, F, K, L, T**
(Function Key on pages 212-213)

DIMENSIONS

| | | | |
|--------------|-----|-----------------------|----------|
| Depth: | 28 | Arm Width: | 19½ |
| Width: | 26 | Seat to Floor Height: | 16½-20½ |
| Height: | 45½ | Usable Seat Depth: | 17½ |
| Seat Depth: | 17½ | Ship Weight: | 44 |
| Seat Width: | 19½ | Cube: | 6.1 |
| Back Width: | 19 | Weight Rating: | 250 lbs. |
| Back Height: | 24½ | | |

PRICE CODE

Vinyl **\$479**

NOTES: Available in Black and Brown vinyl with contrasting top stitch. EN11 features silver frame. EN45 features black frame. Padded loop arms. **HON 5-Year Limited Warranty.**

HON Recommendation: HVL402.EN11 - List Price \$479

HVL601



HIGH-BACK

Pneumatic
Swivel
Tilt
Tilt Tension
Tilt Lock
Loop Arms

Functions: **A, E, F, K, L, T**
(Function Key on pages 212-213)

DIMENSIONS

| | | | |
|--------------|-----|-----------------------|----------|
| Depth: | 27 | Arm Width: | 20½ |
| Width: | 26½ | Seat to Floor Height: | 16¾-20½ |
| Height: | 44 | Usable Seat Depth: | 17 |
| Seat Depth: | 17 | Ship Weight: | 38 |
| Seat Width: | 20½ | Cube: | 4.1 |
| Back Width: | 20½ | Weight Rating: | 250 lbs. |
| Back Height: | 26½ | | |

PRICE CODE

Fabric **\$317**
Leather **\$347**

NOTES: Tailored stitching detail in Black Bonded Leather or Black fabric. Fixed loop arms. Black frame. **HON 5-Year Limited Warranty.**

HON Recommendation: HVL601.SB11 - List Price \$347

HOW TO SPECIFY

Select Model Number

Select Fabric

- SB11** Black Bonded Leather
Specify for models HVL161, HVL171, and HVL601 only
- EN11** Black Vinyl
Specify for model HVL402 only
- EN45** Brown Vinyl
Specify for model HVL402 only
- VA10** Black Fabric
Specify for model HVL601 only

H V L 1 6 1

S B 1 1



GUEST CHAIRS

HVL653



GUEST CHAIR

Sled Base
Padded Arms

DIMENSIONS

| | | | |
|--------------|--------------------------------|-----------------------|--------------------------------|
| Depth: | 23 | Arm Width: | 17 ³ / ₄ |
| Width: | 22 ¹ / ₄ | Seat to Floor Height: | 17 ⁵ / ₈ |
| Height: | 32 | Usable Seat Depth: | 16 ³ / ₄ |
| Seat Depth: | 17 | Ship Weight: | 28 |
| Seat Width: | 20 ¹ / ₄ | Cube: | 3.1 |
| Back Width: | 18 ¹ / ₂ | Weight Rating: | 250 lbs. |
| Back Height: | 12 | | |

PRICE CODE

Leather **\$279**

NOTES: Black Bonded Leather with tailored stitching detail. Frame features steel tubular construction. Black frame.

HON Recommendation: HVL653.SB11 - List Price \$279

SEATING

HOW TO SPECIFY

| | |
|----------------------------|----------------------------------|
| Select Model Number | Select Fabric |
| | SB11 Black Bonded Leather |
| H V L 6 5 3 . | S B 1 1 |



MESH CHAIRS

HVL521



MID-BACK

Pneumatic
Swivel
Tilt
Tilt Tension
Tilt Lock
Arms

Functions: **A, E, F, K, L**
(Function Key on pages 212-213)

DIMENSIONS

| | | | |
|--------------|-----|-----------------------|----------|
| Depth: | 35¼ | Arm Width: | 18½ |
| Width: | 26¼ | Seat to Floor Height: | 17½-22 |
| Height: | 41 | Usable Seat Depth: | 17¾ |
| Seat Depth: | 17¾ | Ship Weight: | 30 |
| Seat Width: | 19½ | Cube: | 4.1 |
| Back Width: | 18¾ | Weight Rating: | 250 lbs. |
| Back Height: | 21½ | | |

PRICE CODE

Fabric **\$375**

NOTES: Comfortable and breathable mesh back. Black fabric seat. Sturdy textured black frame. Fixed-height arms. **HON 5-Year Limited Warranty.**

HON Recommendation: HVL521.VA10 - List Price \$375

HVL525



HIGH-BACK

Pneumatic
Swivel
Tilt
Tilt Tension
Tilt Lock
Fixed Loop Arms

Functions: **A, E, F, K, L, T**
(Function Key on pages 212-213)

DIMENSIONS

| | | | |
|--------------|-----|-----------------------|----------|
| Depth: | 26 | Arm Width: | 20⅞ |
| Width: | 26 | Seat to Floor Height: | 16¾-21¼ |
| Height: | 42¾ | Usable Seat Depth: | 19 |
| Seat Depth: | 19 | Ship Weight: | 33 |
| Seat Width: | 19¾ | Cube: | 3.8 |
| Back Width: | 19¾ | Weight Rating: | 250 lbs. |
| Back Height: | 23 | | |

PRICE CODE

Fabric **\$382**

NOTES: Comfortable and breathable mesh back. Black upholstered seat. Fixed, loop arms. **HON 5-Year Limited Warranty.**

HON Recommendation: HVL525.ES10 - List Price \$382

HOW TO SPECIFY

Select Model Number

Select Fabric

VA10 Black Fabric
Specify for model HVL521 only

ES10 Black Fabric
Specify for model HVL525 only

HVL521.

VA10



NESTING CHAIRS

HVL303



SANDWICH MESH BACK AND SEAT

Upholstered Seat and Back
Casters
Arms

DIMENSIONS

| | | | |
|-------------|-----|-----------------------|----------|
| Depth: | 23¾ | Back Height: | 16 |
| Width: | 23¾ | Seat to Floor Height: | 19¼ |
| Height: | 33½ | Usable Seat Depth: | 18½ |
| Seat Depth: | 18½ | Ship Weight: | 27 |
| Seat Width: | 19½ | Cube: | 2.1 |
| Back Width: | 19½ | Weight Rating: | 250 lbs. |

LIST PRICE

\$341

NOTES: Seat and back upholstered in comfortable and breathable Black Sandwich Mesh. Specify Black (T) or Silver (X) frame. Ships one per carton. **HON 5-Year Limited Warranty.**

HON Recommendation: HVL303.MM10.T - List Price \$341

HOW TO SPECIFY

| | | |
|--|--|---|
| <p>Select Model Number</p> <p>H V L 3 0 3 .</p> | <p>Select Fabric</p> <p>MM10 Black Sandwich Mesh Fabric (only)</p> <p>M M 1 0 .</p> | <p>Select Frame</p> <p>T Black X Silver</p> <p>T</p> |
|--|--|---|

TASK CHAIRS

OPEN MARKET



Icon Legend on page 17

HVL220

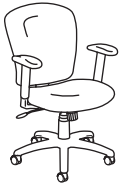

TASK MID-BACK

Pneumatic
Swivel
Tilt
Tilt Tension
Tilt Lock
Height-adjustable Arms

Functions: **A, E, F, K, L, Q**
(Function Key on pages 212-213)

DIMENSIONS

| | | | |
|--------------|-----|-----------------------|----------|
| Depth: | 34½ | Arm Width: | 17¾ |
| Width: | 26¾ | Seat to Floor Height: | 17½-21¼ |
| Height: | 41 | Usable Seat Depth: | 16¾ |
| Seat Depth: | 16¾ | Ship Weight: | 35 |
| Seat Width: | 20 | Cube: | 3.7 |
| Back Width: | 20¼ | Weight Rating: | 250 lbs. |
| Back Height: | 22½ | | |

PRICE CODE

Fabric **\$405**

NOTES: Black fabric. Sturdy textured black frame. Height-adjustable arms. **HON 5-Year Limited Warranty.**

HON Recommendation: HVL220.VA10 - List Price \$405

SEATING

HOW TO SPECIFY

Select
Model Number

H V L 2 2 0 .

Select
Fabric

VA10 Black Fabric

V A 1 0



WORKPLACE TOOLS

Ergonomic Solutions

HVL991

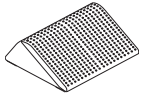

FOOTREST

Anti-Slip Cover

DIMENSIONS

| | | | |
|---------|-----|----------------|------------|
| Depth: | 13¾ | Ship Weight: | 7 Ⓢ |
| Width: | 16 | Cube: | 0.9 |
| Height: | 5½ | Weight Rating: | 250 lbs. |

LIST PRICE

\$89

NOTES: **HON 5-Year Limited Warranty.**

! Available in Black (T) finish ONLY.

SPECIFYING EXAMPLE: HVL991.T

HSCASTER

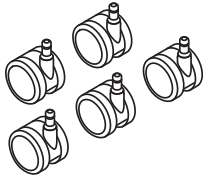

SET OF 5 SOFT CASTERS

DIMENSIONS

| | |
|--------------|------------|
| Size: | 60mm |
| Ship Weight: | 2 Ⓢ |
| Cube: | 0.1 |

LIST PRICE

\$59

! Available in Black finish only, no specification needed.

HOW TO SPECIFY

| | |
|----------------------------|----------------------|
| Select Model Number | Select Finish |
| H V L 9 9 1 . | T Black |

WORKPLACE TOOLS

Chair Mats

OPEN MARKET



Icon Legend on page 17

| | DESCRIPTION | MODEL | SHIP WEIGHT | CUBE | LIST PRICE |
|--|---|------------------|-------------|------|--------------|
|  | Lipped Chair Mat with Studs 60"W x 46"D 48"W x 36"D | HCM4660LS | 13.9 | 1.0 | \$158 |
| | | HCM3648LS | 8.8 | 0.6 | \$95 |
|  | Lipped Chair Mat without Studs 60"W x 46"D 48"W x 36"D | HCM4660LN | 13.2 | 0.5 | \$158 |
| | | HCM3648LN | 8.3 | 0.3 | \$95 |

NOTES:

- Available with studs for carpet and without studs for hard-surface floors.
- Ships rolled.
- **HON 5-Year Limited Warranty.**
- ! Clear finish only. No specification needed.

SEATING

HOW TO SPECIFY

Select Model Number

H C M 4 6 6 0 L S

CROSS REFERENCE INDEX

| MODEL | PAGE | MODEL | PAGE | MODEL | PAGE | MODEL | PAGE |
|--------|--------------------|--------------|------|--------------|-------------------------------|----------------|----------|
| H1522 | 189 | H5901 | 261 | HBTTST42 | 33 | HCTSQR36 | 28 |
| H1526 | 189 | H5902 | 261 | HBTTSTQR30 | 33 | HCTSQR42 | 28 |
| H2091 | 428 | H5903 | 261 | HBTTSTQR36 | 33 | HCWI | 249 |
| H2092 | 428 | H5905 | 262 | HBTTSTQR42 | 33 | HCWPT | 42 |
| H2093 | 428 | H5991 | 262 | HBTTX30L | 34 | HCWTB3656G | 40 |
| H2095 | 428 | H5995 | 262 | HBTTX30S | 34 | HCWTB3656J | 40 |
| H2111 | 360 | H80170 | 68 | HBTTX42L | 34 | HCWTB3684G | 40 |
| H2112 | 360 | H80180 | 68 | HBTTX42S | 34 | HCWTB3684J | 40 |
| H2141 | 361 | H80191 | 68 | HBXRISER | 191 | HCWTDSBM27 | 41 |
| H2142 | 361 | H80192 | 68 | HCATIMM | 267 | HCWTDSBM29 | 41 |
| H2143 | 361 | H80193 | 68 | HCD1 | 190 | HCWTDSBM36 | 41 |
| H2144 | 361 | HAECBH | 151 | HCG6 | 250 | HCWTDSBM42 | 41 |
| H2145 | 361 | HAEHF | 151 | HCG6DF | 250 | HCWTRND30G | 40 |
| H2146 | 361 | HAESS | 151 | HCLA65 | 141, 147, 165, 198 | HCWTRND30J | 40 |
| H2164 | 244 | HARCHA1 | 115 | HCLQS | 257 | HCWTRND36G | 40 |
| H2165 | 244 | HARCHA8 | 115 | HCLQT | 256 | HCWTRND36J | 40 |
| H2191 | 431 | HARCHC1 | 115 | HCM3648LN | 193, 508 | HCWTRND42G | 40 |
| H2192 | 431 | HARCHC8 | 115 | HCM3648LS | 193, 508 | HCWTRND42J | 40 |
| H2194 | 431 | HASB2 | 237 | HCM4660LN | 193, 508 | HCWTSBL18 | 41 |
| H2281 | 368 | HASB2MF | 237 | HCM4660LS | 193, 508 | HCWTSBL27 | 41 |
| H2285 | 368 | HASB3 | 238 | HCOMDOME2 | 205 | HCWTSBL29 | 41 |
| H4001 | 445 | HASB3MF | 238 | HCPU1 | 172, 185 | HCWTSBL36 | 41 |
| H4002 | 445 | HASGBSL | 240 | HCTIMM | 266 | HCWTSBL42 | 41 |
| H4003 | 445 | HASHB1 | 230 | HCT29LX | 29 | HCWTSBM18 | 41 |
| H4008 | 445 | HASHB1MF | 230 | HCT29MT | 29 | HCWTSBM27 | 41 |
| H4022 | 187 | HASHB2 | 232 | HCT29MX | 29 | HCWTSBM29 | 41 |
| H4028 | 187 | HASHB2MF | 232 | HCT29ST | 29 | HCWTSBM36 | 41 |
| H4029 | 187 | HASHB3 | 234 | HCT29SX | 29 | HCWTSBM42 | 41 |
| H4031 | 325 | HASHB3MF | 234 | HCT36LX | 29 | HCWTSF330G | 40 |
| H4033 | 325 | HASHBTC | 236 | HCT36MT | 29 | HCWTSF330J | 40 |
| H4039 | 325 | HASHBTCMF | 236 | HCT36MX | 29 | HCWTSF336G | 40 |
| H4041 | 410 | HASLB1 | 229 | HCT36ST | 29 | HCWTSF336J | 40 |
| H4043 | 410 | HASLB1MF | 229 | HCT36SX | 29 | HCWTSF342G | 40 |
| H4048 | 410 | HASLB2 | 231 | HCT42LX | 29 | HCWTSF342J | 40 |
| H4049 | 410 | HASLB2MF | 231 | HCT42MT | 29 | HCWTSQR30G | 40 |
| H4069 | 418 | HASLB3 | 233 | HCT42MX | 29 | HCWTSQR30J | 40 |
| H4071 | 414 | HASLB3MF | 233 | HCT42ST | 29 | HCWTSQR36G | 40 |
| H4073 | 414 | HASLBTC | 235 | HCT42SX | 29 | HCWTSQR36J | 40 |
| H4075 | 415 | HASLBTCMF | 235 | HCTLDS | 30 | HCWTSQR42G | 40 |
| H4077 | 415 | HASPS | 239 | HCTMDS | 30 | HCWTSQR42J | 40 |
| H4079 | 418 | HASPSMF | 239 | HCTRECT2448 | 28 | HCWTSR3656G | 40 |
| H4091 | 416 | HASSGC | 240 | HCTRECT2460 | 28 | HCWTSR3656J | 40 |
| H4093 | 416 | HASSP | 240 | HCTRECT2472 | 28 | HCWTSR3684G | 40 |
| H4095 | 417 | HBDMAUSB | 184 | HCTRECT3048 | 28 | HCWTSR3684J | 40 |
| H4097 | 417 | HBLH3160 | 69 | HCTRECT3060 | 28 | HD2 | 190 |
| H4099 | 418 | HBLH3170 | 69 | HCTRECT3072 | 28 | HD8 | 190 |
| H5001 | 421 | HBSDCSNT2832 | 145 | HCTRND24 | 28 | HD8X | 172 |
| H5002 | 421 | HBSDFN3030 | 145 | HCTRND30 | 28 | HDPS1 | 197 |
| H51204 | 188 | HBSDRBN2231 | 145 | HCTRND36 | 28 | HE4022 | 187 |
| H51206 | 188 | HBSDRECT2031 | 145 | HCTRND42 | 28 | HE4LSTL18 | 152 |
| H5701 | 480 | HBSDRECT2038 | 145 | HCTROUGH17 | 61, 65, 77, 80, 116, 201, 208 | HE4LSTL30 | 152 |
| H5703 | 480 | HBSDSPY2636 | 145 | HCTROUGH1710 | 61, 65, 77, 80, 116, 201, 208 | HEB4LEG | 139 |
| H5705 | 480 | HBSDTRP2040 | 145 | | | HEBBXRL | 141, 147 |
| H5711 | 481 | HBSMAUSB | 184 | | | HEBS4LEG | 139 |
| H5713 | 481 | HBTMS | 61 | HCTROUGH36 | 61, 65, 80, 116, 208 | HEBS4LEG | 146 |
| H5715 | 481 | HBTTWCW | 34 | HCTROUGH3610 | 61, 65, 80, 116, 208 | HEBY4LEG | 139 |
| H5721 | 484 | HBTTD30 | 34 | HCTS | 30 | HEDRT-2766E-NS | 140 |
| H5723 | 484 | HBTTD42 | 34 | HCTSFT24 | 28 | HEDRT2766E | 138 |
| H5725 | 484 | HBTTTRND30 | 33 | HCTSFT30 | 28 | HEFS01 | 154 |
| H5731 | 485 | HBTTTRND36 | 33 | HCTSFT36 | 28 | HEHP3660E | 137 |
| H5733 | 485 | HBTTTRND42 | 33 | HCTSFT42 | 28 | HEMKR426029BB | 148 |
| H5735 | 485 | HBTTSTFT30 | 33 | HCTSQR24 | 28 | HEMKR426029L | 148 |
| H5795 | 480, 481, 484, 485 | HBTTSTFT36 | 33 | HCTSQR30 | 28 | HEMKR426036BB | 148 |

CROSS REFERENCE INDEX

| MODEL | PAGE | MODEL | PAGE | MODEL | PAGE | MODEL | PAGE |
|---------------|------|-----------|--------------------|--|----------|-----------------|---------------|
| HEMKR426036L | 148 | HFDB42BF | 48 | HFXB29A | 48 | HI2ATA | 343, 356 |
| HEMKR426042BB | 148 | HFL45O | 291 | HFXB29AN | 48 | HI2BTHR | 344 |
| HEMKR426042L | 148 | HFLB2 | 298 | HFXB29B | 48 | HI2FHA | 281, 343, 356 |
| HEMKR427229BB | 148 | HFLB3 | 298 | HFXB42A | 48 | HI2HR | 344 |
| HEMKR427229L | 148 | HFLCC1 | 290 | HFXB42AN | 48 | HIB50 | 349 |
| HEMKR427236BB | 148 | HFLCCIDF | 296 | HFXB42B | 48 | HICS7 | 346 |
| HEMKR427236L | 148 | HFLCO1 | 306 | HGDK3-F | 165, 167 | HIGS7DF | 348 |
| HEMKR427242BB | 148 | HFLCOIDF | 307 | HGRMTAC 30, 51, 65, 80, 172, 204, 323 | | HIEH1 | 354 |
| HEMKR427242L | 148 | HFLDGRMT | 204 | HGRMTAC2 30, 51, 65, 80, 172, 204, 323 | | HIEH2 | 354 |
| HEMKRDIVIDER | 150 | HFLDGRMT3 | 204 | HGRMTDATA 51, 65, 80, 204 | | HIEH3 | 354 |
| HEMKREND29-F | 149 | HFLDGRMT4 | 204 | HGRMTUSB2 51, 65, 172, 204, 323 | | HIGCL | 349 |
| HEMKREND29-SP | 149 | HFLGANG | 291 | HGROM1BLANK | 117 | HIGS6 | 346 |
| HEMKREND36-F | 149 | HFLMC1 | 289 | HGROM2BLANK | 117 | HIGS6DF | 347 |
| HEMKREND36-SP | 149 | HFLMCIDF | 294 | HGTMM | 310 | HILMBR | 343 |
| HEMKREND42-F | 149 | HFLMCIS | 292 | HGVIMM | 311 | HIPAA | 281, 343, 356 |
| HEMKREND42-SP | 149 | HFLMCISDF | 297 | HH870924 | 195 | HISB6 | 346 |
| HEMKRSHELF | 150 | HFLML1 | 289 | HH870924CH | 195 | HISB6DF | 347 |
| HERD42E | 137 | HFLMLIDF | 294 | HH870930 | 195 | HITL1 | 352 |
| HERD48E | 137 | HFLMR1 | 289 | HH870930CH | 195 | HITL2 | 352 |
| HESA2440E | 136 | HFLMRIDF | 295 | HH870942 | 195 | HITL3 | 352 |
| HESA3050E | 136 | HFLRC1 | 288 | HH870942CH | 195 | HITLM | 334 |
| HESH3060E | 136 | HFLRCIDF | 293 | HH870960 | 195 | HITLMKD | 336 |
| HESH6066E | 138 | HFLRCIS | 292 | HH870960CH | 195 | HITLRA | 339 |
| HESKD4872E | 138 | HFLRCISDF | 297 | HHABCASTER | 141 | HITLRAKD | 340 |
| HESN3054E | 136 | HFLSC1 | 288 | HHB02 | 475 | HITS5 | 355 |
| HESNP54E | 136 | HFLSCIDF | 293 | HHB03 | 475 | HITSM | 334 |
| HESPCR | 140 | HFLSCIS | 292 | HHC-ARMPULL15 | 210 | HITSRA | 339 |
| HESQ36E | 137 | HFLSCISDF | 297 | HHC-ARMPULL5 | 210 | HIWM1 | 353 |
| HESQ42E | 137 | HFLSC2 | 302 | HHC-FOOTPULL15 | 210 | HIWM2 | 353 |
| HESQ48E | 137 | HFLSC2DF | 304 | HHC-FOOTPULL5 | 210 | HIWM3 | 353 |
| HESW-3054E-NS | 140 | HFLSO1 | 291 | HHC-PPESTND | 209 | HIWM8 | 355 |
| HESW3054E | 136 | HFLWI45 | 290 | HHC-PPEWALL | 209 | HIWMBT | 337 |
| HESY-3654E-NS | 140 | HFLWI45DF | 296 | HHC-SANSTND-TRAY | 209 | HIWMM | 334 |
| HESY3654E | 136 | HFLWO45 | 290 | HHC-SANSTND | 209 | HIWMMHR | 335 |
| HETD54E | 137 | HFLWO45DF | 296 | HHC-SANSTND2 | 209 | HIWMMKD | 336 |
| HETR2448E | 137 | HFLYO1 | 306 | HHCB50 | 477 | HIWMMMS | 338 |
| HETR2460E | 137 | HFLYOIDF | 307 | HHCG11 | 462 | HIWMMMSKD | 338 |
| HETR2472E | 137 | HFMBIN12 | 151, 178 | HHCG11DF | 463 | HIWMRA | 339 |
| HETR3048E | 137 | HFMBIN3 | 141, 147, 151, 178 | HHCG21 | 462 | HIWMRAKD | 340 |
| HETR3060E | 137 | HFMBIN6 | 151, 178 | HHCG21DF | 463 | HIWMU | 341 |
| HETR3072E | 137 | HFSS7 | 301 | HHCG50 | 462 | HIWMUKD | 342 |
| HETZ3060E | 137 | HFSS74L | 301 | HHCG50DF | 464 | HIWMUL | 341 |
| HF23C | 179 | HFSS74LDF | 303 | HHCGB21 | 465 | HIWMULKD | 342 |
| HFAA01 | 364 | HFTB17N | 48 | HHCGB31 | 465 | HKBS | 186 |
| HFALO2 | 364 | HFTLA2460 | 47 | HHCGBR | 467 | HKTLONG | 186 |
| HFAO3 | 364 | HFTLA3372 | 47 | HHCGBRCH | 467 | HKTMD | 186 |
| HFCG6 | 301 | HFTLA3384 | 47 | HHCMT24 | 208 | HKTSHORT | 186 |
| HFCG6DF | 303 | HFTLA3396 | 47 | HHCMT36 | 208 | HL2DARM | 281 |
| HFCL2 | 302 | HFTLC2460 | 47 | HHCP1 | 462 | HL4DARM | 281 |
| HFCL2DF | 304 | HFTLC3372 | 47 | HHCPIDF | 464 | HLD-M3A | 163 |
| HFDB17B | 48 | HFTLC3384 | 47 | HHCT01 | 477 | HLD-M3AA | 163 |
| HFDB17N | 48 | HFTLC3396 | 47 | HHCT02 | 477 | HLD-M3AB | 163 |
| HFDB29A | 48 | HFTLD26 | 49 | HHCT020 | 476 | HLD-M3F | 163 |
| HFDB29AN | 48 | HFTLD30 | 47 | HHCT024 | 476 | HLD-M3FA | 163 |
| HFDB29B | 48 | HFTLD36 | 47 | HHCT048 | 476 | HLD-M3FB | 163 |
| HFDB42A | 48 | HFTLR12 | 50 | HHCT12 | 477 | HLD-M3T | 163 |
| HFDB42AF | 48 | HFTLS24 | 49 | HHCTC | 466 | HLDA-15 | 165 |
| HFDB42AF72 | 48 | HFTLS30 | 47 | HHCTL4 | 466 | HLDST1 | 196 |
| HFDB42AF84 | 48 | HFTLS36 | 47 | HHCTRT | 466 | HLDV-M3A | 164 |
| HFDB42AF96 | 48 | HFTLW45 | 50 | HHCTS | 466 | HLDV-M3F | 164 |
| HFDB42AFN | 48 | HFTPTL18 | 49 | HHPS1 | 197 | HLDV-MRECT2026A | 164 |
| HFDB42AN | 48 | HFTTAL14 | 50, 323 | HI2AAA | 343, 356 | HLED1 | 194 |
| HFDB42B | 48 | HFXB17B | 48 | | | HLED17A | 195 |

CROSS REFERENCE INDEX

| MODEL | PAGE | MODEL | PAGE | MODEL | PAGE | MODEL | PAGE |
|--------------|----------|--------------|------------------|------------|---------|-----------------|-------------|
| HLED17AS | 195 | HLWBF1-1248W | 176 | HMG2 | 396 | HMTS01 | 224 |
| HLED17AUO | 195 | HLWBF2-1248W | 176 | HMLIS | 316 | HMTS11 | 224 |
| HLED1IOC | 194 | HLWBS-248WT | 176 | HMLISDF | 319 | HMTUMOD26 | 75 |
| HLED2 | 194 | HLWBS-248WW | 176 | HML2S | 316 | HMTUMOD32 | 61, 75, 171 |
| HLED31A | 195 | HLWBS-448WT | 176 | HML2SDF | 320 | HMTUMOD38 | 36, 75 |
| HLED31AS | 195 | HLWBS-448WW | 176 | HML2ST | 318 | HMTUMOD44 | 61, 75 |
| HLED31AUO | 195 | HLWM | 277 | HML2STDF | 322 | HMTUMOD50 | 36, 75 |
| HLEDOSA | 195 | HLWMBT | 279 | HML3S | 317 | HMTUMOD56 | 75 |
| HLEU | 276 | HLWR-12 | 176 | HML3SDF | 321 | HMTUMOD62 | 75 |
| HLEUBT | 279 | HLWU | 277 | HML8851 | 69, 269 | HMTUMOD74 | 75 |
| HLINEARA1 | 115 | HLWUBT | 279 | HML8852 | 69, 269 | HMTUMOD86 | 75 |
| HLINEARA8 | 115 | HMACABLE | 64, 79, 118, 203 | HML8858 | 43 | HMVH-2448(?)-FX | 72 |
| HLINEARCI | 115 | HMAGANG | 61, 77, 141, 201 | HMNI | 393 | HMVH-2448(?)-NS | 73 |
| HLINEARC8 | 115 | HMAJUMP | 64, 79, 203 | HMN2 | 393 | HMVH-3060(?)-FX | 72 |
| HLMSHHR | 281 | HMAPLATE | 64, 79, 118, 203 | HMNT1 | 399 | HMVH-3060(?)-NS | 73 |
| HLSA-CRI2 | 175 | HMAPOWER36 | 79, 203 | HMNT2 | 399 | HMVH-3672(?)-FX | 72 |
| HLSA-HRK | 175 | HMAPOWER362 | 79, 203 | HMPT2448NS | 36 | HMVH-3672(?)-NS | 73 |
| HLSA-SK1220T | 175 | HMAPOWER42 | 79, 203 | HMPT2460NS | 36 | HMVMB-3072WW | 76 |
| HLSA-SK3020T | 175 | HMAPOWER422 | 79, 203 | HMPT2472NS | 36 | HMVMB-3672WW | 76 |
| HLSA-TK12 | 175 | HMAPOWER48 | 64, 79, 203 | HMPT3048NS | 36 | HMVPC-DTLG | 76 |
| HLSA-TK3 | 175 | HMAPOWER482 | 64, 79, 203 | HMPT3060NS | 36 | HMVPC-MP | 76 |
| HLSA-TK6 | 175 | HMAPOWER54 | 79, 203 | HMPT3072NS | 36 | HMVPCA1-1830G | 76 |
| HLSA-WBK52 | 175 | HMAPOWER542 | 79, 203 | HMPTBFX | 35 | HMVPCA1-1830R | 76 |
| HLSC36T-1D | 174 | HMAPOWER60 | 64, 79, 118, 203 | HMPTBNSL | 35 | HMVPCA2-1830G | 76 |
| HLSC36T-1N | 173 | HMAPOWER602 | 64, 79, 203 | HMPTBNSS | 35 | HMVPCA2-1830R | 76 |
| HLSC36T-2D | 174 | HMAPOWER66 | 79, 203 | HMPPT2448 | 35 | HMVPCF-1830G | 76 |
| HLSC36T-2N | 173 | HMAPOWER662 | 79, 203 | HMPPT2460 | 35 | HMVPCF-1830R | 76 |
| HLSC52T-21D | 174 | HMAPOWER72 | 64, 79, 118, 203 | HMPPT2472 | 35 | HMVPCSS-4C | 76 |
| HLSC52T-21N | 173 | HMAPOWER722 | 64, 79, 203 | HMPPT3048 | 35 | HMVPCSS-4C4C | 76 |
| HLSC52T-3D | 174 | HMAPOWER84 | 64, 79, 118, 203 | HMPPT3060 | 35 | HMVPCSS-4C9C | 76 |
| HLSC52T-3N | 173 | HMAPOWER842 | 64, 79, 203 | HMPPT3072 | 35 | HMVPCSS-4O | 76 |
| HLSF52T-21D | 174 | HMAPOWER96 | 64, 79, 118, 203 | HMPVWM28 | 208 | HMVPCSS-4O4C | 76 |
| HLSF52T-21N | 173 | HMAPOWER962 | 64, 79, 203 | HMS1 | 385 | HMVPCSS-4O9C | 76 |
| HLSF52T-3D | 174 | HMASD | 183 | HMS2 | 385 | HMVR-1848(?)-AH | 74 |
| HLSF52T-3N | 173 | HMASPLIT | 64, 79, 118, 203 | HMSCART | 385 | HMVR-1848(?)-FX | 72 |
| HLSL1212 | 198 | HMASTS | 183 | HMSFLTGLD | 386 | HMVR-1848(?)-NS | 73 |
| HLSL1460LS | 196 | HMAVHA | 376 | HMSGANG | 386 | HMVR-1860(?)-AH | 74 |
| HLSL1472LS | 196 | HMAVHAMF | 376 | HMSGLD | 386 | HMVR-1860(?)-FX | 72 |
| HLSL4831MB | 115, 199 | HMAVHN | 375 | HMSSTLGLD | 386 | HMVR-1860(?)-NS | 73 |
| HLSLDRWORG | 198 | HMAVHNMF | 375 | HMT1 | 383 | HMVR-1872(?)-AH | 74 |
| HLT2460T-L3 | 170 | HMAVMA | 374 | HMT1848E | 57 | HMVR-1872(?)-FX | 72 |
| HLT2460T-R3 | 170 | HMAVMAMF | 374 | HMT1848G | 57 | HMVR-1872(?)-NS | 73 |
| HLT2672T-23 | 170 | HMAVMN | 373 | HMT1860E | 57 | HMVR-2436(?)-AH | 74 |
| HLTA-TR24 | 170 | HMAVMNMF | 373 | HMT1860G | 57 | HMVR-2436(?)-FX | 72 |
| HLTM | 278 | HMAVO | 377 | HMT1872E | 57 | HMVR-2436(?)-NS | 73 |
| HLTP | 278 | HMAVOMF | 377 | HMT1872G | 57 | HMVR-2442(?)-AH | 74 |
| HLTSM | 280 | HMBFLIP18L | 59 | HMT2448E | 57 | HMVR-2442(?)-FX | 72 |
| HLTSP | 280 | HMBFLIP18S | 59 | HMT2448G | 57 | HMVR-2442(?)-NS | 73 |
| HLTSU | 280 | HMBFLIP24L | 59 | HMT2460E | 57 | HMVR-2448(?)-AH | 74 |
| HLTU | 278 | HMBFLIP24S | 59 | HMT2460G | 57 | HMVR-2448(?)-FX | 72 |
| HLTV2460T-3 | 171 | HMBFLIP30L | 59 | HMT2472E | 57 | HMVR-2448(?)-NS | 73 |
| HLTV2466T-33 | 171 | HMBFLIP30S | 59 | HMT2472G | 57 | HMVR-2454(?)-AH | 74 |
| HLVBC3330 | 180 | HMBPOST | 59 | HMT3048E | 57 | HMVR-2454(?)-FX | 72 |
| HLVBC4330 | 180 | HMBTLEG18 | 59 | HMT3048G | 57 | HMVR-2454(?)-NS | 73 |
| HLVBC5630 | 180 | HMBTLEG24 | 59 | HMT3060E | 57 | HMVR-2460(?)-AH | 74 |
| HLVMSC3330R | 178 | HME3 | 379 | HMT3060G | 57 | HMVR-2460(?)-FX | 72 |
| HLVMSC4330R | 178 | HMG1 | 389 | HMT3072E | 57 | HMVR-2460(?)-NS | 73 |
| HLVMSC5630R | 178 | HMG2 | 389 | HMT3072G | 57 | HMVR-2466(?)-AH | 74 |
| HLVPM1 | 196 | HMG3 | 390 | HMT5 | 383 | HMVR-2466(?)-FX | 72 |
| HLVPM2 | 197 | HMG4 | 390 | HMTHR3060E | 58 | HMVR-2466(?)-NS | 73 |
| HLVSC3330R | 179 | HMG5 | 390 | HMTHR3060G | 58 | HMVR-2472(?)-AH | 74 |
| HLVSC4330R | 179 | HMG7 | 390 | HMTHR3248E | 58 | HMVR-2472(?)-FX | 72 |
| HLVSC5630R | 179 | HMG1 | 396 | HMTHR3248G | 58 | HMVR-2472(?)-NS | 73 |

CROSS REFERENCE INDEX

| MODEL | PAGE | MODEL | PAGE | MODEL | PAGE | MODEL | PAGE |
|-----------------|------|---------------|------------------|---------------|--|-------------|------|
| HMVR-2484(?)-FX | 72 | HNL1560FD | 114 | HQQICUSH | 442 | HSS4L-30B | 167 |
| HMVR-2484(?)-NS | 73 | HNL1560LD | 113 | HRUCKIL | 436 | HSSA-WB1618 | 167 |
| HMVR-2496(?)-FX | 72 | HNL1560LL | 113 | HRUCK1W | 437 | HSSCL-14A | 168 |
| HMVR-2496(?)-NS | 73 | HNL1560SD | 114 | HRUCK5L | 436 | HSSCL-16B | 168 |
| HMVR-3036(?)-AH | 74 | HNL1566FD | 114 | HRUCK5W | 437 | HSSCL-18B | 168 |
| HMVR-3036(?)-FX | 72 | HNL1566LD | 113 | HSB50 | 221 | HSSST-18B | 169 |
| HMVR-3036(?)-NS | 73 | HNL1566LL | 113 | HSB50DF | 223 | HSSTK-18B | 169 |
| HMVR-3042(?)-AH | 74 | HNL1566SD | 114 | HSCASTER | 266, 267, 281, 343, 356, 457, 484, 485, 507 | HT27FB3060 | 99 |
| HMVR-3042(?)-FX | 72 | HNL1572FD | 114 | | | HT27FB3672 | 99 |
| HMVR-3042(?)-NS | 73 | HNL1572LD | 113 | HSCCR36BPG | 123 | HT27FB4284 | 99 |
| HMVR-3048(?)-AH | 74 | HNL1572LL | 113 | HSCCR36LM | 123 | HT27FB48108 | 99 |
| HMVR-3048(?)-FX | 72 | HNL1572SD | 114 | HSCCR36LMK | 123 | HT27FB48120 | 99 |
| HMVR-3048(?)-NS | 73 | HNL1578FD | 114 | HSCCR48BPG | 123 | HT27FB48144 | 99 |
| HMVR-3054(?)-AH | 74 | HNL1578LD | 113 | HSCCR48LM | 123 | HT27FB48168 | 98 |
| HMVR-3054(?)-FX | 72 | HNL1578LL | 113 | HSCCR48LMK | 123 | HT27FB48180 | 98 |
| HMVR-3054(?)-NS | 73 | HNL1578SD | 114 | HSCCSR2448BPG | 123 | HT27FB48192 | 98 |
| HMVR-3060(?)-AH | 74 | HNL3630TB | 199 | HSCCSR2448LM | 123 | HT27FB48216 | 98 |
| HMVR-3060(?)-FX | 72 | HNL3630WB | 199 | HSCCSR2448LMK | 123 | HT27FB48240 | 98 |
| HMVR-3060(?)-NS | 73 | HNL3636TB | 199 | HSCCSS36BPG | 123 | HT27FB4896 | 99 |
| HMVR-3066(?)-AH | 74 | HNL3636WB | 199 | HSCCSS36LM | 123 | HT27FBM | 99 |
| HMVR-3066(?)-FX | 72 | HNL4930TB | 199 | HSCCSS36LMK | 123 | HT29AL108 | 100 |
| HMVR-3066(?)-NS | 73 | HNL4930WB | 199 | HSCCSS48BPG | 123 | HT29AL120 | 100 |
| HMVR-3072(?)-AH | 74 | HNL4936TB | 199 | HSCCSS48LM | 123 | HT29AL144 | 100 |
| HMVR-3072(?)-FX | 72 | HNL4936WB | 199 | HSCCSS48LMK | 123 | HT29AL168 | 100 |
| HMVR-3072(?)-NS | 73 | HNLMP3628 | 112 | HSCER24BPG | 124 | HT29AL180 | 100 |
| HMVR-3084(?)-FX | 72 | HNLMP5428 | 112 | HSCER24LM | 124 | HT29AL192 | 100 |
| HMVR-3084(?)-NS | 73 | HNLMP7228 | 112 | HSCER24LMK | 124 | HT29AL216 | 100 |
| HMVR-3096(?)-FX | 72 | HNLMP9028 | 112 | HSCCESS24BPG | 124 | HT29AL240 | 100 |
| HMVR-3096(?)-NS | 73 | HNLRC2436 | 112 | HSCCESS24LM | 124 | HT29AL60 | 100 |
| HMVR-3648(?)-AH | 74 | HNLRC2454 | 112 | HSCCESS24LMK | 124 | HT29AL72 | 100 |
| HMVR-3648(?)-FX | 72 | HNLRC2472 | 112 | HSCSI | 220 | HT29AL84 | 100 |
| HMVR-3648(?)-NS | 73 | HNLRC2490 | 112 | HSCS1DF | 222 | HT29AL96 | 100 |
| HMVR-3660(?)-AH | 74 | HPACSM | 183 | HSCS2 | 221 | HT29ALEG | 100 |
| HMVR-3660(?)-FX | 72 | HPACW | 183 | HSCS2DF | 223 | HT29ALM | 100 |
| HMVR-3660(?)-NS | 73 | HPADD | 184 | HSGANG | 220, 223 | HT29FB3060 | 99 |
| HMVR-3672(?)-AH | 74 | HPASD | 184 | HSGS6 | 220 | HT29FB3672 | 99 |
| HMVR-3672(?)-FX | 72 | HPATF | 184 | HSGS6DF | 222 | HT29FB4284 | 99 |
| HMVR-3672(?)-NS | 73 | HPHAP2028E | 60 | HSLV2DAP | 457 | HT29FB48108 | 99 |
| HMVT-2448(?)-FX | 72 | HPHAP2028G | 60 | HSLV4DAP | 457 | HT29FB48120 | 99 |
| HMVT-2448(?)-NS | 73 | HPN1 | 425 | HSLVFAP | 457 | HT29FB48144 | 99 |
| HMVT-3060(?)-FX | 72 | HPN2 | 425 | HSLVLMBR | 457 | HT29FB48168 | 98 |
| HMVT-3060(?)-NS | 73 | HPPMFB | 177 | HSLVSM | 451 | HT29FB48180 | 98 |
| HMVT-3672(?)-FX | 72 | HPPMHK | 177 | HSLVSMMS | 451 | HT29FB48192 | 98 |
| HMVT-3672(?)-NS | 73 | HPPMMT | 177 | HSLVSMR | 453 | HT29FB48216 | 98 |
| HNI | 407 | HPPMPB | 177 | HSLVSMRS | 453 | HT29FB48240 | 98 |
| HNIU | 407 | HPPMPC | 177 | HSLVSMU | 455 | HT29FB4896 | 99 |
| HN6 | 408 | HPWRMOB1 | 205, 241 | HSLVSMUS | 455 | HT29FBM | 99 |
| HN7 | 408 | HPWRMOD2 | 37, 205 | HSLVTMM | 450 | HT36FB3060 | 99 |
| HNATA | 408 | HPWRMOD2UWM | 51, 205 | HSLVTMMKD | 456 | HT36FB3672 | 99 |
| HNFA | 408 | HPWRMOD2WC | 205 | HSLVTMMS | 450 | HT36FB4284 | 99 |
| HNL1530FD | 114 | HPWRMOD3UWM | 51, 205 | HSLVTMR | 452 | HT36FB48108 | 99 |
| HNL1530LD | 113 | HPWRMOD3WC | 205 | HSLVTMRKD | 456 | HT36FB48120 | 99 |
| HNL1530LL | 113 | HPWRMOD4WC | 205 | HSLVTMRS | 452 | HT36FB48144 | 99 |
| HNL1536FD | 114 | HQB | 62, 77, 201 | HSLVTMU | 454 | HT36FB48168 | 98 |
| HNL1536LD | 113 | HQBCJ36 | 62, 77, 201 | HSLVTMUKD | 456 | HT36FB48180 | 98 |
| HNL1536LL | 113 | HQHI-3 | 62, 77, 118, 201 | HSLVTMUS | 454 | HT36FB48192 | 98 |
| HNL1542FD | 114 | HQH5-3 | 62, 77, 118, 201 | HSMPWR-1P-2U | 205 | HT36FB48216 | 98 |
| HNL1542LD | 113 | HQH5-E-3PIE | 118, 201 | HSS4L-06A | 166 | HT36FB48240 | 98 |
| HNL1542LL | 113 | HQH5-E-3PIU2B | 118, 201 | HSS4L-12A | 166 | HT36FB4896 | 99 |
| HNL1548FD | 114 | HQH5-E-3P3B | 118, 201 | HSS4L-14A | 166 | HT36FBM | 99 |
| HNL1548LD | 113 | HQH5-P-3P1B | 62, 77, 118, 201 | HSS4L-16B | 166 | HT42AL60 | 100 |
| HNL1548LL | 113 | HQJ3 | 62, 77, 201 | HSS4L-18B | 166 | HT42AL72 | 100 |
| HNL1548SD | 114 | HQQ1 | 442 | HSS4L-24B | 167 | HT42AL84 | 100 |

CROSS REFERENCE INDEX

| MODEL | PAGE | MODEL | PAGE | MODEL | PAGE | MODEL | PAGE |
|------------------|-------------------|----------------|------|----------------|------|----------------|------|
| HT42AL96 | 100 | HTL(?)24 | 95 | HTLC3072HCTFP | 105 | HTLC4296LCTFP | 103 |
| HT42ALEG | 100 | HTL(?)30 | 95 | HTLC3072HCTFPL | 106 | HTLC4296LCTFPL | 104 |
| HT42FB3060 | 99 | HTL(?)3060 | 94 | HTLC3072HCTFPR | 106 | HTLC4296LCTFPR | 104 |
| HT42FB3672 | 99 | HTL(?)36 | 95 | HTLC3072HCTHP | 105 | HTLC4296LCTHP | 103 |
| HT42FB4284 | 99 | HTL(?)3672 | 94 | HTLC3072HCTP | 105 | HTLC4296LCTP | 103 |
| HT42FB48108 | 99 | HTL(?)42 | 95 | HTLC3072HCTPL | 106 | HTLC4296LCTPL | 104 |
| HT42FB48120 | 99 | HTL(?)42108 | 94 | HTLC3072HCTPR | 106 | HTLC4296LCTPR | 104 |
| HT42FB48144 | 99 | HTL(?)42120 | 94 | HTLC3072LCTFP | 105 | HTLCRED42 | 110 |
| HT42FB48168 | 98 | HTL(?)42144 | 94 | HTLC3072LCTFPL | 106 | HTLCRED42S | 110 |
| HT42FB48180 | 98 | HTL(?)42168 | 94 | HTLC3072LCTFPR | 106 | HTLCRED57 | 110 |
| HT42FB48192 | 98 | HTL(?)42180 | 94 | HTLC3072LCTHP | 105 | HTLCRED57S | 110 |
| HT42FB48216 | 98 | HTL(?)42192 | 94 | HTLC3072LCTP | 105 | HTLCRED72 | 110 |
| HT42FB48240 | 98 | HTL(?)42216 | 94 | HTLC3072LCTPL | 106 | HTLCRED72S | 110 |
| HT42FB4896 | 99 | HTL(?)42240 | 94 | HTLC3072LCTPR | 106 | HTLCUBE108 | 97 |
| HT42FBM | 99 | HTL(?)4284 | 94 | HTLC3096HCTFP | 105 | HTLCUBE120 | 97 |
| HTALWMGR29 | 100 | HTL(?)4296 | 94 | HTLC3096HCTFPL | 106 | HTLCUBE144 | 97 |
| HTALWMGR42 | 100 | HTL(?)48 | 95 | HTLC3096HCTFPR | 106 | HTLCUBE168 | 97 |
| HTBINSLIDE | 110 | HTL(?)48108 | 94 | HTLC3096HCTHP | 105 | HTLCUBE180 | 97 |
| HTFWMGR27 | 99 | HTL(?)48120 | 94 | HTLC3096HCTP | 105 | HTLCUBE192 | 97 |
| HTFWMGR29 | 99 | HTL(?)48144 | 94 | HTLC3096HCTPL | 106 | HTLCUBE216 | 97 |
| HTFWMGR36 | 99 | HTL(?)48168 | 94 | HTLC3096HCTPR | 106 | HTLCUBE240 | 97 |
| HTFWMGR42 | 99 | HTL(?)48180 | 94 | HTLC3096LCTFP | 105 | HTLCUBE48 | 101 |
| HTFXL27 | 102 | HTL(?)48192 | 94 | HTLC3096LCTFPL | 106 | HTLCUBE84 | 97 |
| HTFXL27C | 102 | HTL(?)48216 | 94 | HTLC3096LCTFPR | 106 | HTLCUBE96 | 97 |
| HTFXL27P | 102 | HTL(?)48240 | 94 | HTLC3096LCTHP | 105 | HTLCUBEM | 97 |
| HTFXL29 | 102 | HTL(?)4896 | 94 | HTLC3096LCTP | 105 | HTLCUBES108 | 97 |
| HTFXL29C | 102 | HTL(?)54108 | 94 | HTLC3096LCTPL | 106 | HTLCUBES120 | 97 |
| HTFXL29P | 102 | HTL(?)54120 | 94 | HTLC3096LCTPR | 106 | HTLCUBES144 | 97 |
| HTFXL36 | 102 | HTL(?)54144 | 94 | HTLC4260HCTFP | 103 | HTLCUBES168 | 97 |
| HTFXL36C | 102 | HTL(?)54168 | 94 | HTLC4260HCTFPL | 104 | HTLCUBES180 | 97 |
| HTFXL36P | 102 | HTL(?)54180 | 94 | HTLC4260HCTFPR | 104 | HTLCUBES192 | 97 |
| HTFXL42 | 102 | HTL(?)54192 | 94 | HTLC4260HCTHP | 103 | HTLCUBES216 | 97 |
| HTFXL42C | 102 | HTL(?)54216 | 94 | HTLC4260HCTP | 103 | HTLCUBES240 | 97 |
| HTFXL42P | 102 | HTL(?)54240 | 94 | HTLC4260HCTPL | 104 | HTLCUBES48 | 101 |
| HTFXM27 | 102 | HTLB1048LP | 120 | HTLC4260HCTPR | 104 | HTLCUBES96 | 97 |
| HTFXM27C | 102 | HTLB12048P | 119 | HTLC4260LCTFP | 103 | HTLCUBESM | 97 |
| HTFXM27P | 102 | HTLB1248LP | 120 | HTLC4260LCTFPL | 104 | HTLD60 | 95 |
| HTFXM29 | 102 | HTLB14448P | 119 | HTLC4260LCTFPR | 104 | HTLHP108 | 96 |
| HTFXM29C | 102 | HTLB1448LP | 120 | HTLC4260LCTHP | 103 | HTLHP120 | 96 |
| HTFXM29P | 102 | HTLB1648LP | 120 | HTLC4260LCTP | 103 | HTLHP144 | 96 |
| HTFXM36 | 102 | HTLB16848P | 119 | HTLC4260LCTPL | 104 | HTLHP168 | 96 |
| HTFXM36C | 102 | HTLB1848LP | 120 | HTLC4260LCTPR | 104 | HTLHP180 | 96 |
| HTFXM36P | 102 | HTLB2048LP | 120 | HTLC4272HCTFP | 103 | HTLHP192 | 96 |
| HTFXM42 | 102 | HTLBENCH30 | 109 | HTLC4272HCTFPL | 104 | HTLHP216 | 96 |
| HTFXM42C | 102 | HTLBENCH48 | 109 | HTLC4272HCTFPR | 104 | HTLHP240 | 96 |
| HTFXM42P | 102 | HTLBENCH60 | 109 | HTLC4272HCTHP | 103 | HTLHP84 | 96 |
| HTFXS27 | 102 | HTLBENCHCUSH30 | 109 | HTLC4272HCTP | 103 | HTLHP96 | 96 |
| HTFXS27P | 102 | HTLBENCHCUSH48 | 109 | HTLC4272HCTPL | 104 | HTLHPM | 96 |
| HTFXS29 | 102 | HTLBENCHCUSH60 | 109 | HTLC4272HCTPR | 104 | HTLLECTA | 109 |
| HTFXS29P | 102 | HTLC3060HCTFP | 105 | HTLC4272LCTFP | 103 | HTLM4272 | 94 |
| HTFXS36 | 102 | HTLC3060HCTFPL | 106 | HTLC4272LCTFPL | 104 | HTLM4872 | 94 |
| HTFXS36P | 102 | HTLC3060HCTFPR | 106 | HTLC4272LCTFPR | 104 | HTLM5472 | 94 |
| HTFXS42 | 102 | HTLC3060HCTHP | 105 | HTLC4272LCTHP | 103 | HTLM7248P | 119 |
| HTFXS42P | 102 | HTLC3060HCTP | 105 | HTLC4272LCTP | 103 | HTLMC1828DL | 111 |
| HTFXT27 | 102 | HTLC3060HCTPL | 106 | HTLC4272LCTPL | 104 | HTLMC1828DR | 111 |
| HTFXT27P | 102 | HTLC3060HCTPR | 106 | HTLC4272LCTPR | 104 | HTLMC1828L | 111 |
| HTFXT29 | 102 | HTLC3060LCTFP | 105 | HTLC4296HCTFP | 103 | HTLMC1828O | 111 |
| HTFXT29P | 102 | HTLC3060LCTFPL | 106 | HTLC4296HCTFPL | 104 | HTLMC1828R | 111 |
| HTG1PWR-3P-1B | 65, 117, 206, 323 | HTLC3060LCTFPR | 106 | HTLC4296HCTFPR | 104 | HTLMT4260H | 108 |
| HTG2PWR-3P-1E | 117, 206 | HTLC3060LCTHP | 105 | HTLC4296HCTHP | 103 | HTLMT4260HFR | 108 |
| HTG2PWR-3P-1U-W | 117, 206 | HTLC3060LCTP | 105 | HTLC4296HCTP | 103 | HTLMT4260L | 108 |
| HTG2PWR-3P-2B-2U | 117, 206 | HTLC3060LCTPL | 106 | HTLC4296HCTPL | 104 | HTLMT4272H | 108 |
| HTG2PWR-4P-2B | 117, 206 | HTLC3060LCTPR | 106 | HTLC4296HCTPR | 104 | HTLMT4272HFR | 108 |

CROSS REFERENCE INDEX

| MODEL | PAGE | MODEL | PAGE | MODEL | PAGE | MODEL | PAGE |
|------------|------|--------------|----------|----------|------|-----------|---------------|
| HTLMT4272L | 108 | HTLT168 | 96 | HUTM2040 | 127 | HVL653 | 503 |
| HTLMTHBACK | 108 | HTLT72 | 96 | HUTM2060 | 127 | HVL685 | 471 |
| HTLMTLBACK | 108 | HTLT96 | 96 | HUTM2460 | 127 | HVL691 | 253 |
| HTLMTTV | 108 | HTLXP36 | 101 | HUTM3060 | 127 | HVL693 | 253 |
| HTLP108 | 96 | HTLXP42 | 101 | HUTM3072 | 127 | HVL701 | 486 |
| HTLP120 | 96 | HTLXP48 | 101 | HUTM3672 | 127 | HVL702 | 486 |
| HTLP144 | 96 | HTMC304260 | 107 | HV-UT1 | 198 | HVL705 | 486 |
| HTLP168 | 96 | HTMC304260BB | 107 | HVL102 | 470 | HVL712 | 486 |
| HTLP180 | 96 | HTMC304272 | 107 | HVL103 | 470 | HVL721 | 283 |
| HTLP192 | 96 | HTMC304272BB | 107 | HVL105 | 501 | HVL791 | 402 |
| HTLP216 | 96 | HTMC304296 | 107 | HVL108 | 271 | HVL844 | 468 |
| HTLP240 | 96 | HTMC304296BB | 107 | HVL131 | 501 | HVL852 | 468 |
| HTLP60 | 96 | HTMC424260 | 107 | HVL149 | 439 | HVL853 | 468 |
| HTLP72 | 96 | HTMC424260BB | 107 | HVL151 | 501 | HVL871 | 252 |
| HTLP84 | 96 | HTMC424272 | 107 | HVL161 | 502 | HVL872 | 252 |
| HTLP96 | 96 | HTMC424272BB | 107 | HVL171 | 502 | HVL873 | 252 |
| HTLPB | 119 | HTMC424296 | 107 | HVL205 | 472 | HVL887 | 268 |
| HTLPBS | 119 | HTMC424296BB | 107 | HVL210 | 472 | HVL888 | 268 |
| HTLPM | 96 | HTPCIF48 | 241 | HVL215 | 472 | HVL991 | 192, 422, 507 |
| HTLPRES | 115 | HTPCIF72 | 241 | HVL220 | 506 | HVL995 | 472 |
| HTLR108 | 97 | HTPHWIF72 | 241 | HVL232 | 370 | HVLPERCH | 422 |
| HTLR120 | 97 | HTPKIT48 | 241 | HVL238 | 370 | HWHIC | 496 |
| HTLR144 | 97 | HTPKIT482 | 241 | HVL282 | 400 | HWHICCF | 496 |
| HTLR168 | 97 | HTPKIT60 | 241 | HVL283 | 400 | HWHISP | 490 |
| HTLR180 | 97 | HTPKIT602 | 241 | HVL303 | 505 | HWHISPCF | 491 |
| HTLR192 | 97 | HTPKIT72 | 241 | HVL304 | 225 | HWHISS | 490 |
| HTLR216 | 97 | HTPKIT722 | 241 | HVL314 | 225 | HWHISSCF | 491 |
| HTLR240 | 97 | HTPLATEVHAU | 117, 207 | HVL402 | 502 | HWHITCP | 497 |
| HTLR36 | 101 | HTPSPLIT | 241 | HVL508 | 357 | HWHITCPCF | 498 |
| HTLR42 | 101 | HTRACK | 110 | HVL511 | 469 | HWHITCS | 497 |
| HTLR48 | 101 | HTSSRD | 298 | HVL515 | 469 | HWHITCSCF | 498 |
| HTLR84 | 97 | HTTLEG108 | 100 | HVL518 | 357 | HWH2SP | 492 |
| HTLR96 | 97 | HTTLEG120 | 100 | HVL521 | 504 | HWH2SPCF | 493 |
| HTLRC108 | 97 | HTTLEG144 | 100 | HVL525 | 504 | HWH2SS | 492 |
| HTLRC120 | 97 | HTTLEG168 | 100 | HVL531 | 432 | HWH2SSCF | 493 |
| HTLRC144 | 97 | HTTLEG180 | 100 | HVL532 | 432 | HWH3SP | 494 |
| HTLRC168 | 97 | HTTLEG192 | 100 | HVL534 | 433 | HWH3SPCF | 495 |
| HTLRC180 | 97 | HTTLEG216 | 100 | HVL539 | 433 | HWH3SS | 494 |
| HTLRC192 | 97 | HTTLEG240 | 100 | HVL541 | 282 | HWH3SSCF | 495 |
| HTLRC216 | 97 | HTTLEG60 | 100 | HVL581 | 270 | HWHACPP | 500 |
| HTLRC240 | 97 | HTTLEG72 | 100 | HVL582 | 270 | HWHACPS | 500 |
| HTLRC48 | 101 | HTTLEG84 | 100 | HVL585 | 270 | HWHBCPP | 500 |
| HTLRC84 | 97 | HTTLEG96 | 100 | HVL601 | 502 | HWHBCPS | 500 |
| HTLRC96 | 97 | HTTLEGM | 100 | HVL604 | 471 | HWHGB | 500 |
| HTLRM | 97 | HTXLEG | 102 | HVL605 | 471 | HWHLP | 499 |
| HTLRM | 97 | HTXLEGSH | 102 | HVL606 | 440 | HWHSP18 | 499 |
| HTLSHELF | 110 | HUMPWR-IP-2U | 205, 241 | HVL616 | 440 | HWMCLPLG | 208 |
| HTLT120 | 96 | HUTM1872 | 127 | HVL643 | 251 | HWMCLPSM | 208 |
| HTLT144 | 96 | | | | | | |

NOTES

NOTES

NOTES

NOTES

NOTES

NOTES

INFORMATION ON ORDERING PARTS

When parts are needed to repair HON products, the following guidelines should be followed to expedite the process.

1. Warranty orders are submitted on HON Ready via the Quick Claim tool. To purchase repair parts, please visit HONAccessories.com which can be found on HON.com.
2. There are no discounts applied to parts. Pricing quoted is the net value. Parts pricing is subject to change without notice.
3. For a part not covered by warranty applicable shipping charges will apply.
4. All keys are \$6.00 each plus a shipping and handling fee of \$3.00 per shipping location.
5. Parts may be paid for with an approved credit card. Approved Cards: MasterCard, VISA and American Express.
6. Payment terms for invoiced parts are Net 30 days.
7. Due to short leadtimes on parts, no changes will be accepted after the order has been placed.
8. When placing a **warranty** parts order:

If the product is under warranty, the product serial number must be provided. Most finished goods products have a serial number placed on them at the factory. The label containing the serial number is located:

Vertical Files — right side of the uppermost drawer

Lateral Files — left side of the uppermost drawer or shelf

Desk Towers — outside of top drawer

Desks, Credenzas, & Returns — on the outside, kneespace side of the top drawer. Fully extend the drawer to find it.

Desks, Credenzas, Corner Units, Bridges, Peninsulas & Returns without drawers — underside of top

Tables and Stands — underside of the top

Table Trucks — underside of side rail

Cabinets & Bookcases — left inner side of the case

Modular Component Top and Backs — underside of top

Modular End Panels — top inside surface

Reception Stations — top inside surface of back panel

Organizers — top inside surface of left end panel near back panel

Vertical Paper Manager — back panel inside surface near top

Pedestals — bottom drawer right side exterior

Seating — underside of the seat

Panels — underside of the top cap

Hutches, Storage Units, Overhead Storage — underside of the shelf

Hanging Bookshelves — underside of shelf

NOTE: Removal of the serial number tag from the product voids the warranty.

An important note regarding Product Serial Numbers:

HON desks, tables, chairs, files and systems components are tagged with a serial number. This number helps us identify *when and where your product was made*, and to identify and correct the root causes for the problem. NEITHER THE DEALER NOR THE CONSUMER SHOULD REMOVE THIS TAG UNDER ANY CIRCUMSTANCES. To do so immediately voids your Warranty coverage for that particular item *and prevents us from further identifying it*. Instead, please transcribe the number and call your Dealer.

Make your space work.

HON®



2021 List Pricer

WORKSPACES

Desks | Workstations | Storage | Universal Screens

Effective Date
October 2021

LIST PRICER

Effective Date: October 2021

- All illustrations and specifications in this publication are based on the latest product information available at the time of print. For the most recent version, please go to www.hon.com.
- Software support packages furnished to the customer, either by The HON Company or by another source, which support the sale of HON products are superseded by printed price lists.
- All dimensions shown in this publication are nominal.
- Pricing is subject to change without notice.
- All orders are subject to prices in effect at the time of order.
- Ordering information appears at the beginning of a section complete with examples on how to specify. These specifying information pages are referenced at the bottom center of product pages.
- HON Full Lifetime Warranty applies unless otherwise noted.
- HON nationwide customer service:
Phone: (800) 833-3964

HON LIST PRICER

Table of Contents

INTRODUCTION

| | |
|---|-------|
| Table of Contents..... | 1-4 |
| Additions..... | 5-6 |
| Discontinuations..... | 7 |
| HON Full Lifetime Warranty Information..... | 8 |
| HON Limited 5-Year Warranty Information..... | 9 |
| Ordering Information..... | 10 |
| Integrated Design Solutions..... | 11 |
| Tailored Solutions Ordering Information..... | 12 |
| Customer's Own Material Ordering Information..... | 13-14 |
| Partnership Textile Information..... | 15 |
| Paint Program..... | 16 |
| Environmental Statement..... | 17 |
| Important Information..... | 18 |
| Legend..... | 19 |
| Fabric Patterns & Codes..... | 20 |
| Lead Times..... | 21 |
| Fabric Patterns & Codes..... | 22-24 |
| Panel Fabric Patterns & Codes..... | 25-26 |

DESKS

| | |
|--|-------|
| Features Offered on HON Laminate Caseworks..... | 27 |
| Concinnity™ | 28 |
| Concinnity™ Ordering Information | 29 |
| Concinnity™ Laminate Design/Materials Information | 30-31 |
| Concinnity™ Laminate Ordering/Specification Information | 32-33 |
| Concinnity™ Cord Management..... | 34-35 |
| Concinnity™ Typicals..... | 36-40 |
| Concinnity™ Desks..... | 41-43 |
| Concinnity™ Peninsulas..... | 44-45 |
| Concinnity™ Corner Unit..... | 46 |
| Concinnity™ Credenzas..... | 47 |
| Concinnity™ Low Credenzas..... | 48 |
| Concinnity™ Returns..... | 49 |
| Concinnity™ Bridges..... | 50 |
| Concinnity™ Stack-on Storage Applications | 51-52 |
| Concinnity™ Stack-on Storage..... | 53-57 |
| Concinnity™ Wall Mount Storage Applications | 58-59 |
| Concinnity™ Wall Mount Storage..... | 60-63 |
| Concinnity™ Bookcase Hutches..... | 64-65 |
| Concinnity™ Reception Stations..... | 66-68 |
| Concinnity™ Mobile Pedestals..... | 69 |
| Concinnity™ Lateral Files..... | 70 |
| Concinnity™ Storage Cabinets..... | 71-72 |
| Concinnity™ Wardrobes..... | 73 |
| Concinnity™ Storage Towers..... | 74 |
| Concinnity™ Bookcases..... | 75 |
| Concinnity™ Components | 76-77 |
| Concinnity™ Components — Worksurfaces..... | 78-81 |
| Concinnity™ Components — Supports..... | 82 |
| Concinnity™ Components — Modesty/Back Panels..... | 83 |
| Concinnity™ Modesty/Back Panels..... | 84-86 |
| Concinnity™ Components — Supports..... | 87 |
| Concinnity™ Kneespace Clearance End Panels..... | 88 |
| Concinnity™ Components — Supports..... | 89-94 |
| Concinnity™ Height Adjustable Bases..... | 95 |

| | |
|--|---------|
| Concinnity™ Components — Privacy Screens..... | 96 |
| Concinnity™ Privacy Screens..... | 97 |
| Concinnity™ Components — Supports..... | 98-101 |
| Concinnity™ Components — Pedestal Tops..... | 102 |
| Concinnity™ Components — Pedestal Back Panels..... | 103 |
| Concinnity™ Accessories..... | 104-105 |
| Concinnity™ Accessories — Cable Management & Electrical..... | 106-107 |
| Concinnity™ Accessories — Paper Organizers..... | 108 |
| Concinnity™ Paper Organizer Compatibility..... | 109 |
| Concinnity™ Accessories — Lock Kits..... | 110 |
| Concinnity™ Accessories — Task Lights..... | 111 |
| Concinnity™ Accessories..... | 112-114 |
| Coordinate™ | 115 |
| Coordinate™ Ordering Information | 116 |
| Coordinate™ Height Adjustable Bases..... | 117 |
| Coordinate™ Worksurfaces..... | 118-120 |
| Coordinate™ Screens..... | 121 |
| Coordinate™ Accessories..... | 122 |
| Coordinate™ Worksurfaces..... | 123 |
| Systems Worksurfaces — 120 Degree Corner..... | 124 |
| Coordinate™ Shared Components..... | 125 |
| Coordinate™ Accessories..... | 126-127 |
| Coze™ | 128 |
| Coze™ Table Desks..... | 129-130 |
| Mod | 131 |
| Mod Ordering Information | 132 |
| Mod Laminate Grain Direction | 133 |
| Mod Typicals..... | 134-136 |
| Mod Bundles Typicals..... | 137-139 |
| Mod Laminate Modular Components..... | 140-141 |
| Mod Laminate Modular Storage Components..... | 142-144 |
| Mod Laminate and Metal Desk Modular Components..... | 145 |
| Mod Laminate Modular Storage Components..... | 146 |
| Mod Conference Table Modular Components..... | 147 |
| Mod Reception Modular Components..... | 148 |
| Valido™ | 149 |
| Valido™ Ordering Information | 150 |
| Valido™ Typicals..... | 151-153 |
| Valido™ Laminate Modular Desks..... | 154 |
| Valido™ Modular Credenzas..... | 155 |
| Valido™ Modular Returns..... | 156 |
| Valido™ Laminate Modular Components..... | 157-158 |
| Valido™ Laminate Wood Desks — Full Pedestals..... | 159-160 |
| Valido™ Laminate Wood Desks — 3/4 Pedestals..... | 161-162 |
| Valido™ Shared Components & Accessories..... | 163-179 |
| Valido™ Accessories..... | 180-181 |
| Voi™ | 182 |
| Voi™ Ordering Information | 183 |
| Voi™ Laminate Typicals..... | 184-189 |
| Voi™ Bundles Typicals..... | 190-192 |
| Voi™ Specifying/Design Guide | 193-197 |
| Voi™ Laminate Worksurfaces — Rectangle..... | 198-200 |
| Voi™ Worksurface Supports..... | 201-203 |
| Voi™ Standing-Height Worksurface Supports..... | 204 |
| Voi™ Standing-Height Laminate Support..... | 205 |

| | |
|---|---------|
| Voi™ — Coordinate™ Sit-to-Stand Worksurfaces..... | 206 |
| Voi™ Height Adjustable Bases..... | 207 |
| Voi™ Laminate Support/Support Pedestals..... | 208 |
| Voi™ Laminate Support/Support Storage..... | 209 |
| Voi™ Modesty Panels..... | 210-211 |
| Voi™ Privacy Screens..... | 212-214 |
| Voi™ Laminate Overhead Storage..... | 215 |
| Voi™ Laminate Overhead and Stack-on Storage..... | 216 |
| Voi™ Laminate Shared Overhead Storage Components..... | 217 |
| Voi™ Overhead Storage Supports/Accessories..... | 218 |
| Voi™ Laminate Stack-on Storage — Built-up..... | 219 |
| Voi™ Laminate Low Credenzas..... | 220-221 |
| Voi™ Laminate Low Footed Credenzas..... | 222-223 |
| Voi™ Laminate Credenzas..... | 224 |
| Voi™ Laminate Mobile Storage..... | 225 |
| Voi™ Laminate Storage..... | 226 |
| Voi™ Laminate Storage Cubes..... | 227 |
| Voi™ Laminate Storage Cube Bundles..... | 228 |
| Voi™ Laminate Storage Towers..... | 229-231 |
| Voi™ Laminate Storage..... | 232 |
| Voi™ Laminate Bookcases..... | 233 |
| Voi™ Accessories..... | 234-240 |
| Voi™ Softwire Electrical Components..... | 241 |
| Voi™ Electrical Components..... | 242-243 |
| Workwall™ | 245 |
| Workwall Ordering Information | 246 |
| Workwall Statement of Line | 247 |
| Workwall Specifying/Design Guide | 248-252 |
| Workwall Typicals..... | 253-255 |
| Workwall Fabric Tiles..... | 256-257 |
| Workwall Glass Markerboard Tiles..... | 258 |
| Workwall Laminate Tiles..... | 259 |
| Workwall Laminate Media Tiles..... | 260 |
| Workwall Painted Metal Tiles..... | 261 |
| Workwall Slotted Tool Tiles..... | 262 |
| Workwall Accessories..... | 263-264 |
| 10500 Series™ | 265 |
| 10500 Series™ Ordering Information | 266-267 |
| 10500 Series™ Typicals..... | 268-270 |
| 10500 Series™ Bundles Typicals..... | 271-273 |
| 10500 Series™ Laminate Modular Components..... | 274-278 |
| 10500 Series™ Worksurfaces..... | 279 |
| 10500 Series™ Worksurface Supports..... | 280-284 |
| 10500 Series™ Components — Supports..... | 285 |
| 10500 Series™ Height Adjustable Bases..... | 286 |
| 10500 Series™ Shared Components..... | 287-288 |
| 10500 Series™ Laminate Modular Components..... | 289-291 |
| 10500 Series™ Laminate Wood Desks — Full Pedestals..... | 292-295 |
| 10500 Series™ Laminate Wood Desks — 3/4 Pedestals..... | 296-297 |
| 10500 Series™ Shared Components & Accessories..... | 298-308 |
| 10500 Series™ Storage..... | 309 |
| 10500 Series™ Shared Components & Accessories..... | 310-320 |
| 10500 Series™ Laminate Occasional Tables..... | 321 |

For information regarding HON registered and unregistered trademarks, please go to hon.com/protected-marks. Haworth®, Herman Miller®, Knoll®, and Steelcase® are registered trademarks of their respective owners and use of the marks do not imply affiliation or endorsement of The HON Company or its products.

LIST PRICER

Effective Date: October 2021

- All illustrations and specifications in this publication are based on the latest product information available at the time of print. For the most recent version, please go to www.hon.com.
- Software support packages furnished to the customer, either by The HON Company or by another source, which support the sale of HON products are superseded by printed price lists.
- All dimensions shown in this publication are nominal.
- Pricing is subject to change without notice.

- All orders are subject to prices in effect at the time of order.
- Ordering information appears at the beginning of a section complete with examples on how to specify. These specifying information pages are referenced at the bottom center of product pages.
- HON Full Lifetime Warranty applies unless otherwise noted.
- HON nationwide customer service:
Phone: (800) 833-3964

HON LIST PRICER

Table of Contents

| | | | | | | | | | | | | | | | | | | | | | | | | | | | | | | | | | | | | | | | | | | | | | | | | | | | | | | | | | | | | | | | | | | | | | | | | | | | | | | | | | | | | | | | | | | | | | | | | | | | | | | | | | | | | | | | | | | | | | | | | | | | | | | | | | | | | | | | | | | | | | | | | | | | | | | | | | | | | | | | | | | | | | | | | | | | | | | | | | | | | | | | | | | | | | | | | | | | | | | | | | | | | | | | | | | | | | | | | | | | | | | | | | | | | | | | | | | | | | | | | | | | | | | | | | | | | | | | | | | | | | | | | | | | | | | | | | | | | | | | | | | | | | | | | | | | | | | | | | | | |
|--|---------|--------------------------------|---------|----------------------------|-----|---|-----|----------------------------|---------|------------------------------------|---------|--|---------|---|---------|--|---------|--|---------|--------------------------------|---------|----------------------------|-----|----------------------------|---------|--|---------|--------------------------------|---------|----------------------|-----|---|-----|--------------------------|---------|--------------------------|---------|----------------------------|-----|---|-----|--------------------------------|---------|--------------------------------|---------|---------------------------|-----|--|-----|-------------------------------|-----|-------------------------------|---------|----------------------------|-----|---|-----|---|-----|--------------------------------------|-----|------------------------------------|---------|--|-----|----------------------------------|-----|--|-----|--------------------------------|---------|---|---------|--------------------------------|-----|---------------------|--|---------------------|-----|--|-----|-------------|---------|---------------------|---------|------------------------|---------|----------------------|-----|---|-----|--|---------|----------------------|---------|--------------------------------|-----|------------------------------|---------|---------------------------------|-----|----------------------------|-----|--|---------|---|-----|--------------------------------------|---------|--|-----|---------------------------|---------|-------------------------------------|-----|------------------------------------|-----|---------------------------------|-----|-------------------------|-----|---------------------------|-----|-------------------------|---------|---|-----|--|-----|--|---------|--------------------------------------|---------|---------------------------------|-----|--------------------------------|-----|----------------------------------|-----|------------------------------|-----|------------------------------|-----|---------------------------------|-----|---|-----|---|-----|--------------------------------|-----|----------------------------------|-----|--|-----|------------------------------------|-----|---|-----|----------------------------|-----|-------------------------------------|-----|---------------------------------------|-----|---|---------|--|-----|--------------------------|-----|---|-----|--|---------|--------------------------|---------|----------------------------------|---------|--------------------------------------|-----|-------------------------------------|-----|--|-----|--|-----|-----------------------------|-----|---------------------------|-----|----------------------------------|---------|----------------------------------|-----|--|-----|--|-----|---|-----|--|-----|-----------------------|-----|---|---------|--------------------------------------|-----|--|-----|---|---------|---|---------|---|---------|---|---------|--|---------|---|---------|---|---------|---|---------|---|---------|--|-----|--|-----|-----------------------------|-----|----------------------------|-----|---------------------------------|-----|------------------------------------|-----|---|-----|---------------------------------------|-----|------------------------------------|-----|----------------------------|-----|-------------------------------------|-----|--|-----|---|-----|-----------------------|-----|---|-----|---|---------|-----------------------------------|---------|--------------------------------------|-----|---|---------|--|-----|--|---------|--|-----|---|-----|---|-----|--|-----|--|-----|--|-----|---|-----|---|-----|--|-----|---|-----|--|-----|--|-----|---|-----|--|-----|
| 10500 Series™ Shared Components & Accessories..... | 322-325 | 10500 Series™ Accessories..... | 326-327 | 10700 Series™ | 328 | 10700 Series™ Ordering Information | 329 | 10700 Series™ Typical..... | 330-332 | 10700 Series™ Bundles Typical..... | 333-335 | 10700 Series™ Laminate Modular Components..... | 336-341 | 10700 Series™ Laminate Wood Desks — Full Pedestals..... | 342-343 | 10700 Series™ Laminate Wood Desks — 3/4 Pedestals..... | 344-345 | 10700 Series™ Shared Components and Accessories..... | 346-358 | 10700 Series™ Accessories..... | 359-360 | 94000 Series™ | 361 | 94000 Series™ Typical..... | 362-363 | 94000 Series™ Laminate Wood Desks..... | 364-369 | 94000 Series™ Accessories..... | 370-372 | Mentor® | 373 | Mentor® Ordering Information | 374 | Mentor® Steel Desks..... | 375-376 | Mentor® Accessories..... | 377-379 | Metro Classic | 380 | Metro Classic Ordering Information | 381 | Metro Classic Steel Desks..... | 382-383 | Metro Classic Accessories..... | 384-386 | 34000 Series | 387 | 34000 Series Ordering Information | 388 | 34000 Series Steel Desks..... | 389 | 34000 Series Accessories..... | 390-392 | 38000 Series™ | 393 | 38000 Series™ Ordering Information | 394 | 38000 Series™ Typical — 3/4 Height Pedestals..... | 395 | 38000 Series™ Typical — Modular..... | 396 | 38000 Series™ Bundles Typical..... | 397-398 | 38000 Series™ Steel Desks — 3/4 Pedestals..... | 399 | 38000 Series™ Modular Desks..... | 400 | 38000 Series™ Shared Components and Accessories..... | 401 | 38000 Series™ Accessories..... | 402-404 | 38000 Series™ Steel Stack-on Units..... | 405-406 | 38000 Series™ Accessories..... | 407 | WORKSTATIONS | | Abode™ | 409 | Abode™ Ordering Information | 410 | Abode™..... | 411-412 | Abode™ Typical..... | 413-417 | Abode™ Components..... | 418-421 | Abound® | 422 | Abound® Ordering Information | 423 | Abound® Fabric Patterns & Codes | 424-425 | Abound® Typical..... | 426-427 | Abound® Open Base Typical..... | 428 | Abound® Frames Overview..... | 429-432 | Abound® Connector Overview..... | 433 | Abound® Tile Overview..... | 434 | Abound® Specifying/Design Guide | 435-436 | Abound® Working with Tiles | 437 | Abound® Gallery Panels Overview..... | 438-443 | Abound® Systems Electrical and Data..... | 444 | Abound® Panel Frames..... | 445-446 | Abound® Open Base Panel Frames..... | 447 | Abound® Stacking Panel Frames..... | 448 | Abound® Stiffener Supports..... | 449 | Abound® Panel Door..... | 450 | Abound® Sliding Door..... | 451 | Abound® Connectors..... | 452-453 | Abound® Variable Height Finished End and Wall Starter Kits..... | 454 | Wall Hanger Bars and Off-Module Bracket..... | 455 | Abound® Tackable Acoustical Tiles..... | 456-457 | Abound® Power/Data Fabric Tiles..... | 458-459 | Abound® Hard-surface Tiles..... | 460 | Abound® Clear Glass Tiles..... | 461 | Abound® Frosted Glass Tiles..... | 462 | Abound® Frameless Glass..... | 463 | Abound® Pass-thru Tiles..... | 464 | Abound® Slotted Tool Tiles..... | 465 | Systems Paper Management Support Bar..... | 465 | Systems Paper Management Accessories..... | 466 | Abound® Markerboard Tiles..... | 467 | Abound® Painted Metal Tiles..... | 468 | Abound® Custom Material Bracket Kit..... | 469 | Abound® Gallery Panels — Wing..... | 470 | Abound® Gallery Panels — Wing, Accepts Glass..... | 471 | Abound® Gallery Glass..... | 472 | Abound® Gallery Connector Kits..... | 473 | Abound® Gallery Panel Tackboards..... | 474 | Abound® Gallery-to-Gallery Connections..... | 475-478 | Abound® Height Adjustable Tie-In Brackets..... | 479 | Accelerate® | 480 | Accelerate® Ordering Information | 481 | Accelerate® Fabric Patterns & Codes | 482-483 | Accelerate® Typical..... | 484-485 | Accelerate® Panels Overview..... | 486-487 | Accelerate® Working with Panels..... | 488 | Accelerate® Connector Overview..... | 489 | Accelerate® Tackable Raceway Panels..... | 490 | Accelerate® Top-Tier Glass Panels..... | 491 | Accelerate® Panel Door..... | 492 | Accelerate® Top Caps..... | 493 | Accelerate® Stacking Panels..... | 494-495 | Accelerate® Frameless Glass..... | 496 | Accelerate® Strengthened Connection Posts..... | 497 | Accelerate® Strengthened Connections — Connector Straps..... | 498 | Accelerate® Variable Height Finished End and Wall Starter Kits..... | 499 | Accelerate® Bracket Kits and Stability Feet..... | 500 | Empower® | 501 | Empower® Fabric Screens — All Panel Models | 502-503 | Empower® Finish Options | 504 | Empower® Step-by-Step Guide | 505 | Empower® 72”W Typical with 24”D Worksurfaces..... | 506-508 | Empower® 60”W Typical with 24”D Worksurfaces..... | 509-510 | Empower® 72”W Typical with 30”D Worksurfaces..... | 511-512 | Empower® 60”W Typical with 30”D Worksurfaces..... | 513-514 | Empower® 120° Workstation Typical..... | 515-516 | Empower® 72”W Height Adjustable Typical with 24”D Worksurfaces..... | 517-518 | Empower® 60”W Height Adjustable Typical with 24”D Worksurfaces..... | 519-520 | Empower® 72”W Height Adjustable Typical with 30”D Worksurfaces..... | 521-522 | Empower® 60”W Height Adjustable Typical with 30”D Worksurfaces..... | 523-524 | Empower® Legs for Linear Applications..... | 525 | Empower® Legs for 120° Applications..... | 526 | Empower® Support Beams..... | 527 | Empower® Wire Troughs..... | 528 | Empower® Return Components..... | 529 | Empower® Systems Worksurfaces..... | 530 | Systems Worksurfaces — 120 Degree Corner..... | 531 | Empower® Height Adjustable Bases..... | 532 | Empower® Systems Worksurfaces..... | 533 | Empower® Side Screens..... | 534 | Empower® Center Screens Fabric..... | 535 | Empower® Center Screens Frosted Glass..... | 536 | Empower® Modesty Panels/End of Run Screens..... | 537 | Empower® Typical..... | 538 | Empower® Height Adjustable Typical..... | 539 | Empower® Electrical Specifying Information | 540-543 | Empower® Electrical and Data..... | 544-545 | Empower® Electrical Accessories..... | 546 | Empower® — Voi® Laminate Low Credenzas..... | 547-548 | Empower® — Voi® Laminate Mobile Storage..... | 549 | Empower® — Voi® Laminate Storage Towers..... | 550-551 | Empower® — Contain® Metal Credenzas..... | 552 | Empower® — Contain® Footed Metal Credenzas..... | 553 | Empower® — Contain® Metal Credenzas with Laminate Fronts..... | 554 | Empower® — Contain® Footed Metal Credenzas with Laminate Fronts..... | 555 | Empower® — Contain® Metal Credenzas Accessories..... | 556 | Empower® — Contain® Metal Personal Towers..... | 557 | Empower® — Contain® Metal Side Access Towers..... | 558 | Empower® — Contain® Metal Personal Towers with Laminate Fronts..... | 559 | Empower® — Contain® Metal Side Access Towers with Laminate Fronts..... | 560 | Empower® — Contain® Footed Metal Personal Towers..... | 561 | Empower® — Contain® Footed Metal Side Access Towers..... | 562 | Empower® — Contain® Footed Metal Personal Towers with Laminate Fronts..... | 563 | Empower® — Contain® Footed Metal Side Access Towers with Laminate Fronts..... | 564 | Empower® — Contain® Metal Pedestals..... | 565 |
|--|---------|--------------------------------|---------|----------------------------|-----|---|-----|----------------------------|---------|------------------------------------|---------|--|---------|---|---------|--|---------|--|---------|--------------------------------|---------|----------------------------|-----|----------------------------|---------|--|---------|--------------------------------|---------|----------------------|-----|---|-----|--------------------------|---------|--------------------------|---------|----------------------------|-----|---|-----|--------------------------------|---------|--------------------------------|---------|---------------------------|-----|--|-----|-------------------------------|-----|-------------------------------|---------|----------------------------|-----|---|-----|---|-----|--------------------------------------|-----|------------------------------------|---------|--|-----|----------------------------------|-----|--|-----|--------------------------------|---------|---|---------|--------------------------------|-----|---------------------|--|---------------------|-----|--|-----|-------------|---------|---------------------|---------|------------------------|---------|----------------------|-----|---|-----|--|---------|----------------------|---------|--------------------------------|-----|------------------------------|---------|---------------------------------|-----|----------------------------|-----|--|---------|---|-----|--------------------------------------|---------|--|-----|---------------------------|---------|-------------------------------------|-----|------------------------------------|-----|---------------------------------|-----|-------------------------|-----|---------------------------|-----|-------------------------|---------|---|-----|--|-----|--|---------|--------------------------------------|---------|---------------------------------|-----|--------------------------------|-----|----------------------------------|-----|------------------------------|-----|------------------------------|-----|---------------------------------|-----|---|-----|---|-----|--------------------------------|-----|----------------------------------|-----|--|-----|------------------------------------|-----|---|-----|----------------------------|-----|-------------------------------------|-----|---------------------------------------|-----|---|---------|--|-----|--------------------------|-----|---|-----|--|---------|--------------------------|---------|----------------------------------|---------|--------------------------------------|-----|-------------------------------------|-----|--|-----|--|-----|-----------------------------|-----|---------------------------|-----|----------------------------------|---------|----------------------------------|-----|--|-----|--|-----|---|-----|--|-----|-----------------------|-----|---|---------|--------------------------------------|-----|--|-----|---|---------|---|---------|---|---------|---|---------|--|---------|---|---------|---|---------|---|---------|---|---------|--|-----|--|-----|-----------------------------|-----|----------------------------|-----|---------------------------------|-----|------------------------------------|-----|---|-----|---------------------------------------|-----|------------------------------------|-----|----------------------------|-----|-------------------------------------|-----|--|-----|---|-----|-----------------------|-----|---|-----|---|---------|-----------------------------------|---------|--------------------------------------|-----|---|---------|--|-----|--|---------|--|-----|---|-----|---|-----|--|-----|--|-----|--|-----|---|-----|---|-----|--|-----|---|-----|--|-----|--|-----|---|-----|--|-----|

For information regarding HON registered and unregistered trademarks, please go to hon.com/protected-marks. Haworth®, Herman Miller®, Knoll®, and Steelcase® are registered trademarks of their respective owners and use of the marks do not imply affiliation or endorsement of The HON Company or its products.

LIST PRICER

Effective Date: October 2021

- All illustrations and specifications in this publication are based on the latest product information available at the time of print. For the most recent version, please go to www.hon.com.
- Software support packages furnished to the customer, either by The HON Company or by another source, which support the sale of HON products are superseded by printed price lists.
- All dimensions shown in this publication are nominal.
- Pricing is subject to change without notice.
- All orders are subject to prices in effect at the time of order.
- Ordering information appears at the beginning of a section complete with examples on how to specify. These specifying information pages are referenced at the bottom center of product pages.
- HON Full Lifetime Warranty applies unless otherwise noted.
- HON nationwide customer service:
Phone: (800) 833-3964

HON LIST PRICER

Table of Contents

| | | | | | |
|--|---------|---|---------|--|---------|
| Empower® — Contain® Footed Metal Pedestals..... | 566 | Versé® | 645 | Contain® Footed Metal Pedestals with | |
| Empower® — Contain® Metal Pedestals | | Versé® Panel System..... | 646-649 | Laminate Fronts..... | 703-704 |
| with Laminate Fronts..... | 567 | | | Flagship® | 705 |
| Empower® — Contain® Footed Metal Pedestals | | STORAGE | | Flagship® Ordering Information | 706 |
| with Laminate Fronts..... | 568 | Overview of Personal Storage and Pedestals | 650 | Flagship® Hanging and Standard Height | |
| Empower® — Flagship® Mobile Pedestals..... | 569 | HON Lateral Files at a Glance..... | 651 | Pedestals..... | 707 |
| Empower® Workplace Tools..... | 570 | HON Vertical Files at a Glance..... | 652 | Flagship® Mobile Pedestals..... | 708 |
| Empower® Accessories..... | 571 | Storage and Files Ordering Information | 653 | Flagship® 18" Deep Lateral Files with Drawers..... | 709 |
| Gravitation™ Power Beam | 572 | Brigade® | 654 | Flagship® Lateral File with Storage..... | 710 |
| Gravitation™ Power Beam Ordering | | Brigade® Ordering Information | 655 | Flagship® Modular Storage..... | 711 |
| Information | 573-574 | Brigade® Standard Height Pedestals..... | 656 | Flagship® Bookcases..... | 712 |
| Gravitation™ 48"W Bundles..... | 575 | Brigade® 800 Series Lateral Files w/Drawers..... | 657 | Flagship® Storage Cabinets..... | 713 |
| Gravitation™ 60"W Bundles..... | 576 | Brigade® 800 Series Lateral Files w/Storage..... | 658 | Flamesafe™ Ordering Information | 714 |
| Gravitation™ 72"W Bundles..... | 577 | Brigade® 700 Series Lateral Files w/Drawers..... | 659 | FlameSafe™ Fire-Resistant Files..... | 715 |
| Gravitation™ Power Beam..... | 578-580 | Brigade® 700 Series Lateral Files w/Storage..... | 660 | Fuse™ | 716 |
| Gravitation™ Power Beam Electrical..... | 581 | Brigade® 600 Series Lateral Files w/Drawers..... | 661 | Fuse™ Ordering Information | 717 |
| Gravitation™ Power Beam Screens..... | 582 | Brigade® Metal Dividers..... | 662 | Fuse™ Pedestals..... | 718 |
| Systems Shared Components | 583 | Brigade® Steel Bookcases..... | 663 | Fuse™ Digital Lock Specifications..... | 719 |
| Systems Overhead and Shelves Specifying | 584-585 | Brigade® Storage Cabinets..... | 664 | Fuse™ Mobile Pedestals..... | 720 |
| Systems Overhead and Shelves..... | 586 | Contain® | 665 | Fuse™ Mobile Pedestals with eLock..... | 721 |
| Systems ETA Overheads and Shelves..... | 587 | Contain® Ordering Information | 666 | Fuse™ Freestanding Pedestals..... | 722 |
| Systems Overhead Storage..... | 588 | Contain® Metal Storage | 667 | Fuse™ Freestanding Pedestals with eLock..... | 723 |
| Systems Laminate Front Overhead Storage..... | 589 | Contain® Metal Credenzas..... | 668 | Fuse™ Pedestal Cushion..... | 724 |
| Voi® Overhead Storage..... | 590-591 | Contain® Footed Metal Credenzas..... | 669 | Fuse™ Undermount Storage..... | 725 |
| Voi® Overhead and Stack-on Storage..... | 592 | Contain® Metal Credenzas with Laminate | | Fuse™ Workplace Tools..... | 726 |
| Voi® Shared Overhead Storage Components..... | 593 | Fronts..... | 670 | Storage Islands | 727 |
| Systems Overhead and Shelves..... | 594 | Contain® Footed Metal Credenzas with | | Storage Islands Ordering Information | 728 |
| Systems Accessories..... | 595-596 | Laminate Fronts..... | 671 | Storage Islands Specifying Guide..... | 729-730 |
| Abound® Electrical and Data..... | 597-599 | Contain® Personal Files..... | 672 | Storage Islands Planning Typical..... | 731-732 |
| Accelerate® Electrical and Data..... | 600-601 | Contain® Lateral Files..... | 673 | Storage Islands Specifying Guide..... | 733 |
| Systems Electrical and Data..... | 602 | Contain® Lateral File Accessories..... | 674 | Storage Islands Top Only Applications..... | 734 |
| Systems Electrical Specifying Information | 603-605 | Contain® Metal Credenzas Accessories..... | 675-676 | Storage Islands Tops for Use with 2 End Panels..... | 735 |
| Working with Cable Management..... | 606 | Contain® Towers..... | 677 | Storage Islands Tops for Use with 2 End Panels | |
| Systems Electrical Components..... | 607-612 | Contain® Lockers & Wardrobes..... | 678 | and Back/Septum..... | 736 |
| Systems Electrical and Data..... | 613 | Contain® Digital Lock Specifications..... | 679 | Storage Islands — Islands Tops for Use with 1 End | |
| Systems Working with Worksurfaces | | Contain® Metal Personal Towers..... | 680 | Panel and Septum..... | 737 |
| and Supports..... | 614-616 | Contain® Metal Side Access Towers..... | 681 | Storage Islands — Islands Septum/Back and End | |
| Systems Worksurfaces — Primary..... | 617-618 | Contain® Metal Personal Towers with | | Panels..... | 738 |
| Systems Worksurfaces — Wedge..... | 619 | Laminate Fronts..... | 682 | Storage Islands Peninsula Supports..... | 739 |
| Systems Worksurfaces — Corner..... | 620-621 | Contain® Metal Side Access Towers with | | 400 Series | 740 |
| Systems Worksurfaces — 120 Degree Corner..... | 622 | Laminate Fronts..... | 683 | 400 Series Lateral Files..... | 741 |
| Systems Worksurfaces — Corner Cove..... | 623-624 | Contain® Footed Metal Personal Towers..... | 684 | Vertical Files | 742 |
| Systems Worksurfaces — Jetty / Peninsula..... | 625 | Contain® Footed Metal Side Access Towers..... | 685 | Vertical Files Ordering Information | 743 |
| Systems Worksurfaces — Half-Round / | | Contain® Footed Metal Personal Towers with | | 210 Series Vertical Files — 28½"D..... | 744 |
| Quarter Round / 60° Wedge..... | 626 | Laminate Fronts..... | 686 | 310 Series Vertical Files — 26½"D..... | 745 |
| Systems Countertops — Straight and Corner..... | 627-628 | Contain® Footed Metal Side Access Towers with | | 510 Series Vertical Files — 25"D..... | 746 |
| Systems Shelves — Corner Shelves..... | 629 | Laminate Fronts..... | 687 | Lateral File Accessories..... | 747 |
| Systems Worksurface Supports..... | 630-632 | Contain® 18"W Slim Metal Personal Towers..... | 688-689 | Vertical File Accessories..... | 748 |
| Worksurface Brackets..... | 633 | Contain® 18"W Slim Personal Towers with | | Mobile Pedestals..... | 749 |
| Systems Worksurface Supports..... | 634 | Laminate Fronts..... | 690-691 | Pedestal Accessories..... | 750-751 |
| Standing-Height Worksurface Supports..... | 635 | Contain® Wardrobes..... | 692-693 | Laminate Bookcases | 752 |
| Systems Standard Height Support Pedestals..... | 636 | Contain® Metal Lockers..... | 694 | Bookcases Ordering Information | 753 |
| Voi® Laminate Support Pedestals..... | 637 | Contain® Metal Lockers with Laminate Fronts..... | 695 | 10500 Series™ Laminate Bookcases..... | 754 |
| Voi® Laminate Support Storage..... | 638 | Contain® Metal Lockers with eLock..... | 696 | 1870 Series Laminate Bookcases..... | 755 |
| Systems Accessories — Paper Management / | | Contain® Metal Lockers with Laminate Fronts | | UNIVERSAL SCREENS | |
| Markerboards..... | 639 | and eLock..... | 697 | Acoustic Solutions by unika vaev | 757 |
| Systems Accessories — Task Lights..... | 640 | Contain® eLock Accessories..... | 698 | Acoustic Solutions Ordering Information | 758-759 |
| Systems Accessories — Electrical..... | 641 | Contain® Metal Pedestals..... | 699 | Acoustic Solutions Wall..... | 760 |
| Systems Accessories — Monitor Arms..... | 642 | Contain® Footed Metal Pedestals..... | 700-701 | Acoustic Solutions Ceiling Tiles and Screens..... | 761 |
| Systems Accessories..... | 643-644 | Contain® Metal Pedestals with Laminate Fronts..... | 702 | | |

For information regarding HON registered and unregistered trademarks, please go to hon.com/protected-marks. Haworth®, Herman Miller®, Knoll®, and Steelcase® are registered trademarks of their respective owners and use of the marks do not imply affiliation or endorsement of The HON Company or its products.

LIST PRICER

Effective Date: October 2021

- All illustrations and specifications in this publication are based on the latest product information available at the time of print. For the most recent version, please go to www.hon.com.
- Software support packages furnished to the customer, either by The HON Company or by another source, which support the sale of HON products are superseded by printed price lists.
- All dimensions shown in this publication are nominal.
- Pricing is subject to change without notice.
- All orders are subject to prices in effect at the time of order.
- Ordering information appears at the beginning of a section complete with examples on how to specify. These specifying information pages are referenced at the bottom center of product pages.
- HON Full Lifetime Warranty applies unless otherwise noted.
- HON nationwide customer service:
Phone: (800) 833-3964

HON LIST PRICER

Table of Contents

| | |
|---|---------|
| Acoustic Solutions Floor Screens..... | 762-763 |
| Desktop Screens Ordering Information | 764 |
| Desktop Screens..... | 765-766 |
| Universal Screens Ordering Information | 767 |
| Universal Screens Table Screens..... | 768-769 |
| Universal Screens Plexi-Glass Screens..... | 770 |
| Universal Screens Floor Screens..... | 771 |
| Universal Screens Panel Stackers..... | 772 |

ACCESSORIES

| | |
|-------------------------------|-----|
| Core Removable Lock Kits..... | 773 |
| Touch-up Paint..... | 774 |

INDEX

| | |
|------------------------------------|---------|
| Cross Reference Index..... | 775-792 |
| Information on Ordering Parts..... | 800 |

ADDITIONS

NEW ADDITIONS: PRODUCTS

| Desks | Effective Date | Desks | Effective Date |
|--|----------------|---|----------------|
| Coordinate™ Models: HHATB2S2LT, HHATB2S2LC, HHATB3S2LT, HHATB2S2LC, HHATM3S2LT, HHATB3S3LT, HHATB3S3LC, HHATW224OCT, HHATW2246CT, HHATW2252CT, HHATW2258CT, HHATW2264CT, HHATW227OCT, HHATW2276CT, HHATW2282CT, HHATW2288CT, HHATW2294CT, HHATW284OCT, HHATW2846CT, HHATW2852CT, HHATW2858CT, HHATW2864CT, HHATW287OCT, HHATW2876CT, HHATW2882CT, HHATW2888CT, HHATW2894CT, HHATW2442CT, HHATW2448CT, HHATW2454CT, HHATW246OCT, HHATW2466CT, HHATW2472CT, HHATW2478CT, HHATW2484CT, HHATW249OCT, HHATW2496CT, HHATW3042CT, HHATW3048CT, HHATW3054CT, HHATW306OCT, HHATW3066CT, HHATW3072CT, HHATW3078CT, HHATW3084CT, HHATW309OCT, HHATW3096CT, HHATCC583422L, HHATCC584622L, HHATCC584628L, HHATCC703422L, HHATCC704622L, HHATCC704628L, HHATCC583422R, HHATCC584622R, HHATCC584628R, HHATCC703422R, HHATCC704622R, HHATCC704628R, HHATCC603624L, HHATCC604824L, HHATCC604830L, HHATCC722624L, HHATCC724824L, HHATCC724830L, HHATCC603624R, HHATCC604824R, HHATCC604830R, HHATCC722624R, HHATCC724824R, HHATCC724830R, HHATW2246EA, HHATW2252EA, HHATW2258EA, HHATW2846EA, HHATW2852EA, HHATW2858EA, HHATW2448EA, HHATW2454EA, HHATW246OEA, HHATW3048EA, HHATW3054EA, HHATW306OEA, HHABBT | July 1, 2021 | Workwall Models: HWWT718F, HWWT724F, HWWT730F, HWWT736F, HWWT742F, HWWT748F, HWWT754F, HWWT760F, HWWT1518F, HWWT1524F, HWWT1530F, HWWT1536F, HWWT1542F, HWWT1548F, HWWT1554F, HWWT1560F, HWWT2218F, HWWT2224F, HWWT2230F, HWWT2236F, HWWT2242F, HWWT2248F, HWWT2254F, HWWT2260F, HWWT3018F, HWWT3024F, HWWT3036F, HWWT3042F, HWWT3048F, HWWT3054F, HWWT3060F, HWWT3718F, HWWT3724F, HWWT3730F, HWWT3736F, HWWT3742F, HWWT3748F, HWWT3754F, HWWT3760F, HWWT4518F, HWWT4524F, HWWT4530F, HWWT4536F, HWWT4542F, HWWT4548F, HWWT4554F, HWWT4560F, HWWT1530M, HWWT1536M, HWWT2230M, HWWT2236M, HWWT3030M, HWWT3036M, HWWT3730M, HWWT3736M, HWWT3742M, HWWT3748M, HWWT3754M, HWWT3760M, HWWT4530M, HWWT4536M, HWWT4542M, HWWT4548M, HWWT4554M, HWWT4560M, HWWT718L, HWWT724L, HWWT730L, HWWT736L, HWWT1518L, HWWT1524L, HWWT1530L, HWWT1536L, HWWT2218L, HWWT2224L, HWWT2236L, HWWT3018L, HWWT3024L, HWWT3030L, HWWT3036L, HWWT3718L, HWWT3724L, HWWT3730L, HWWT3736L, HWWT4518L, HWWT4524L, HWWT4530L, HWWT4536L, HWWT3036V, HWWT3042V, HWWT3048V, HWWT3736V, HWWT3742V, HWWT3748V, HWWT3754V, HWWT4536V, HWWT4542V, HWWT4548V, HWWT4554V, HWWT718P, HWWT724P, HWWT730P, HWWT736P, HWWT1518P, HWWT1524P, HWWT1530P, HWWT1536P, HWWT2218P, HWWT2224P, HWWT2230P, HWWT2236P, HWWT3018P, HWWT3024P, HWWT3030P, HWWT3036P, HWWT724T, HWW730T, HWWT736T, HWWT742T, HWWT748T, HWWT754T, HWWT760T, HWWT1524T, HWWT1530T, HWWT1536T, HWWT1542T, HWWT1548T, HWWT1554T, HWWT1560T, HWWASHELF18, HWWASHELF24, HWWASHELF30, HWWASHELF36, HWWARAIL18, HWWARAIL24, HWWARAIL30, HWWARAIL36, HWWARAIL42, HWWARAIL48, HWWARAIL54, HWWARAIL60, HWWATS, HWWASB, HWWAST, HWWAP, HWWAPH, HWWAC, HWWAH | July 1, 2021 |
| Mod Models: HLPLPEN7236E, HLPLPEN6630E | June 1, 2021 | 10500 Series™ Models: H10521E, H105209E, H10522E, H10523E, H10525RE, H10526LE, H105201RE, H105202LE, H105203RE, H105204LE, H105205RE, H105206LE | July 1, 2021 |
| Valido® Models: H11521E, H11522E, H11523E, H11525RE, H11526LE, H115201RE, H115202LE, H115203RE, H115204LE | June 1, 2021 | 10700 Series™ Models: H10721E, H10722E | July 1, 2021 |
| | | 38000 Series™ Models: H38941E, H38942E, H38966E | July 1, 2021 |

ADDITIONS

| Workstations | Effective Date |
|--|----------------|
| Abound® | July 1, 2021 |
| Models: HRVF5724P, HRVF5730P, HRVF5736P, HRVF5742P, HRVF5748P, HRVF5760P, HRVTC24F, HRVTC30F, HRVTC36F, HRVTC42F, HRVTC48F, HRVTC54F, HRVTC60F, HRVTC66F, HRVTC72F, HRVTC78F, HRVTC84F, HRVTC90F, HRVTC96F, HRFF5724P, HRFF5730P, HRFF5736P, HRFF5742P, HRFF5748P, HRFF5760P, HRVC7PLF, HRVC15PLF, HRVC22PLF, HRVC30PLF, HRVC35PLF, HRVC42PLF, HRVC50PLF, HRVC57PL, HRVC57PLF, HRVC65PLF, HRVC80PLF, HRVC7PTF, HRVC15PTF, HRVC22PTF, HRVC30PTF, HRVC35PTF, HRVC42PTF, HRVC50PTF, HRVC57PT, HRVC57PTF, HRVC65PTF, HRVC80PTF, HRVC7PXF, HRVC15PXF, HRVC22PXF, HRVC30PXF, HRVC35PXF, HRVC42PXF, HRVC50PXF, HRVC57PX, HRVC57PXF, HRVC65PXF, HRVC80PXF, HRVC7PSF, HRVC15PSF, HRVC22PSF, HRVC30PSF, HRVC35PSF, HRVC42PSF, HRVC50PSF, HRVC57PS, HRVC57PSF, HRVC65PSF, HRVC80PSF, HRVC35PY2F, HRVC42PY2F, HRVC50PY2F, HRVC57PY2, HRVC57PY2F, HRVC65PY2F, HRVC35PY3F, HRVC42PY3F, HRVC50PY3F, HRVC57PY3, HRVCPY3F, HRVC65PY3F, HRVC15PFF, HRVC30PFF, HRVC35PFF, HRVC42PFF, HRVC50PFF, HRVC57PF, HRVC57PFF, HRVC65PFF, HRVC80PFF, HRVC7PFV, HRVC15PFV, HRVC22PFV, HRVC30PFV, HRVC7FFV, HRVC15FFV, HRVC65PWF, HRVT5224T, HRVT5230T, HRVT5236T, HRVT5242T, HRVT5248T, HRVT5260T, HRVT5224E, HRVT5230E, HRVT5236E, HRVT5242E, HRVT5248E, HRVT5260E, HRVT0724FF, HRVT0730FF, HRVT0736FF, HRVT0742FF, HRVT0748FF, HRVT0754FF, HRVT0760FF, HRVT0766FF, HRVT0772FF, HRVT0778FF, HRVT0784FF, HRVT0790FF, HRVT0796FF, HRVT1524FF, HRVT1530FF, HRVT1536FF, HRVT1542FF, HRVT1548FF, HRVT1554FF, HRVT1560FF, HRVT1566FF, HRVT1572FF, HRVT1578FF, HRVT1584, HRVT1590FF, HRVT1596FF, HRVBR1524F, HRVBR1530F, HRVBR1536F, HRVBR1542F, HRVBR1548F, HRVBR1560F, HRVBR1566F, HRVBR1572F, HRVBR1524PF, HRVBR1530PF, HRVBR1536PF, HBCKIT24F, HBCKIT30F, HBCKIT36, HBCKIT42F, HBCKIT48F, HBCKIT60F, HBCKIT66F, HBCKIT72F, HBCKIT24F, HBCKIT30F, HBCKIT36F | |
| Accelerate® | July 1, 2021 |
| Models: HEFGS0720, HEFGS0724, HEFGS0730, HEFGS0736, HEFGS0742, HEFGS0748, HEFGS0754, HEFGS0760, HEFGS0766, HEFGS0772, HEFGS1520, HEFGS1524, HEFGS1530, HEFGS1536, HEFGS1542, HEFGS1548, HEFGS1554, HEFGS1560, HEFGS1566, HEFGS1572, HEVHG07P, HEVHG15P | |
| Shared Components | July 1, 2021 |
| Model: HOLEG18 | |

| Fabrics and Finishes | Effective Date |
|--|----------------|
| Laminates | July 1, 2021 |
| Handspun Chestnut (LAHC), Handspun Dove (LAHD), Handspun Pearl (LAHP), Handspun Slate (LAHS) | |

DISCONTINUATIONS

| Desks | Effective Date | Workstations | Effective Date |
|--|-------------------------------|---|--|
| Coordinate™ Models: HS1100, HS1101, HHAW2448P, HHAW2448PN, HHAW2454P, HHAW2460P, HHAW2460PN, HHAW2466P, HHAW2472P, HHAW2472PN, HHAW2484P, HHAW2484PN, HHAW2484PNS, HHAW2484PS, HHAW2496P, HHAW2496PN, HHAW2496PNS, HHAW2496PS, HHAW3048P, HHAW3048PN, HHAW3054P, HHAW3060P, HHAW3060PN, HHAW3066P, HHAW3072PN, HHAW3084P, HHAW3084PN, HHAW3084PNS, HHAW3084PS, HHAW3096P, HHAW3096PN, HHAW3096PNS, HHAW3096PS, HHAWD2450PN, HHAWD3062PN, HHAWV603624LP, HHAWV603624RP, HHAWV604824LP, HHAWV604824RP, HHAWV604830LP, HHAWV604830RP, HHAWV723624LP, HHAWV723624RP, HHAWV724824LP, HHAWV724824RP, HHAWV724830LP, HREC3S3LTF, HREC3S3LCF, HREC2S2LTF, HREC2S2LCF, HMREC3S2LTF, HREC3S2LTF, HREC3S2LCF | December 31, 2021 | Accelerate® Models: HEFG0720, HEFG0724, HEFG0730, HEFG0736, HEFG0742, HEFG0748, HEFG0754, HEFG0760, HEFG0766, HEFG0772, HEFG1520, HEFG1524, HEFG1530, HEFG1554, HEFG1536, HEFG1542, HEFG1548, HEFG1560, HEFG1566, HEFG1572 | December 31, 2021 |
| Coordinate™ Models: HHAB2S2L, HHAB3S2L, HHAB3S3L Model: HS1102 | July 1, 2021 June 30, 2021 | Fabrics and Finishes Fabrics Clyde Weathered (CLYD09) Laminates Sheer Mesh (A5) Canyon Zephyr (K9) Desert Zephyr (K8) Shadow Zephyr (K1) Grey Tigris (L6) Whitestone (K4) | December 31, 2020 June 30, 2022 June 30, 2022 June 30, 2022 June 30, 2022 June 30, 2022 |
| Mod Models: HLPLPEN7236, HLPLPEN6630 | December 31, 2021 | | |
| Valido® Models: H115201R, H115202L, H115203R, H115204L, H11521, H11522, H11523, H11525R, H11526L | December 31, 2021 | | |
| 10500 Series™ Models: H105201R, H105202L, H105203R, H105204L, H105205R, H105206L, H105209, H10521, H10522, H10523, H10525R, H10526L, H105T2430C, H105T3036C | December 31, 2021 | | |
| 10700 Series™ Models: H10721, H10722 | December 31, 2021 | | |
| 38000 Series™ Models: H38941, H38942, H38966 | December 31, 2021 | | |

HON FULL LIFETIME WARRANTY INFORMATION



FULL LIFETIME WARRANTY

YOUR HON FULL LIFETIME WARRANTY

Every time you purchase a HON product, you're making an investment in your future. We're proud to play a part in that future, and you can trust us to do our best for as long as you need us.

The HON Full Lifetime Warranty is our assurance to you that the HON desks, workstations, seating, tables, or storage you purchase will be free from defective material or workmanship for the life of the product.

In the unlikely event that any HON product or component covered by the HON Full Lifetime Warranty should fail under normal workplace use as a result of defective material or workmanship, HON shall repair or replace with comparable product (at HON's discretion), free of charge.

WHAT'S COVERED BY THE HON FULL LIFETIME WARRANTY?

Your HON Full Lifetime Warranty applies to product manufactured after January 1, 2011. All HON product lines, materials, and components are covered by the HON Full Lifetime Warranty except for the items described below.

The specific product lines, materials, and components listed below are covered under HON's Full 12-Year, Full 10-Year, and Full 5-Year Warranties (from date of purchase).

HON'S FULL 12-YEAR WARRANTY

- Electrical components (lamps and ballasts are not covered)
- 4-Way Stretch Mesh
- Seating controls
- Pneumatic Cylinders
- Wood Seating
- Accessories
- Laminate Surfaces

HON'S FULL 10-YEAR WARRANTY

- Coordinate™ Height Adjustable Bases (HHATB)

HON'S FULL 7-YEAR WARRANTY

- Coordinate™ Legacy Bases (HHAB and HREC)
- Workwall Markerboard Glass Tiles

HON'S FULL 5-YEAR WARRANTY

- All LED task lights
- Panel and seating textiles
- Coordinate™ ETA Height Adjustable Base (HHABETA2S2L)
- Coze™
- Between™ Multi-Purpose Table
- Acoustic Solutions by Unika Vaev
- Mod

HON'S FULL 1-YEAR WARRANTY

- Healthy Workplace Tools & Acrylic Screens

These warranties apply to HON products sold within the United States of America, U.S. Territories, and Canada, as well as U.S. Military and Federal Agency purchases (regardless of location).

IS ANYTHING NOT COVERED?

There are a few exclusions to the HON Full Lifetime Warranty and to the 12-, 10-, and 5-year warranties. These exclusions are:

- All HON products that are covered under a separate 5-year warranty.
- Color-fastness or matching of colors, woodgrains, or textures occurring in wood, leather, or other materials that naturally exhibit inherent color variations.
- Customer's own materials (COM) selected by and used at the request of the user.
- Modifications or attachments to the product that are not approved by The HON Company and product failures resulting from such modifications or attachments.
- Product normal wear and tear, which are to be expected over the course of ownership.
- Products that were not installed, used, or maintained in accordance with product instructions and warnings.
- Products used for rental purposes.
- Damage caused by cleaning chemicals.
- Dye transfer caused by external contaminants (including clothing and accessory dyes such as those used on denim jeans) may migrate to lighter colors. This phenomenon is increased by humidity and temperature and is irreversible.
- Fabric pattern match seat to back or chair to chair. If pattern match is needed, please submit a Tailored Solutions request or contact HON Customer Support/Tailored Solutions with questions.

WARRANTY REQUESTS OR QUESTIONS?

Your HON Dealer is our mutual partner in supporting your warranty requests. To obtain service under this warranty, please contact your HON dealer. If you are not sure who your dealer is, please call HON Customer Support at 800.833.3964.

THAT'S YOUR HON FULL LIFETIME WARRANTY AS AN OWNER OF HON PRODUCT, THE WARRANTY EXPLAINED HERE IS YOUR SOLE AND EXCLUSIVE REMEDY. THERE ARE SOME EXCEPTIONS IF YOU PURCHASED THE PRODUCT FOR HOME OR PERSONAL USE WHICH ARE EXPLAINED BELOW. TO THE EXTENT ALLOWED BY LAW, THE HON COMPANY MAKES NO OTHER WARRANTY, EITHER EXPRESS OR IMPLIED, INCLUDING ANY WARRANTY OF MERCHANTABILITY OR FITNESS FOR A PARTICULAR PURPOSE. THE HON COMPANY WILL NOT BE LIABLE FOR ANY CONSEQUENTIAL OR INCIDENTAL DAMAGES.

A WORD ABOUT PURCHASES FOR HOME OR PERSONAL USE

Please note, this section only applies if you purchased your HON product for your home or for your own personal or family use. HON's warranties give you specific legal rights and you may have other rights, which vary from state to state. As a consumer purchaser, the complete exclusion of implied warranties noted in the above paragraph does not apply to you, however, to the extent allowed by applicable state law, the implied warranties are limited to the applicable term of the warranty. Some states do not allow the exclusion or limitation of incidental or consequential damages, so the above exclusion or limitation may not apply to you.

HON LIMITED 5-YEAR WARRANTY INFORMATION



LIMITED 5-YEAR WARRANTY

The HON Company promises to repair or replace HON products or components covered under this warranty that are found to be defective in material or workmanship within five (5) years from the date of original purchase so long as you, the original purchaser, still owns it. This is your sole and exclusive remedy. This warranty is subject to the provisions below. It applies to the products listed here manufactured after January 1, 2018.

LIMITATIONS:

- Upholstery on chairs is warranted for two years from date of purchase.
- Damage caused by the carrier in-transit is handled under separate terms.

EXCLUSIONS:

This warranty does not apply and no other warranty applies to:

- Normal wear and tear, which are to be expected over the course of ownership.
- Modifications or attachments to the product that are not approved by The HON Company.
- Products that were not installed, used or maintained in accordance with product instructions and warnings.
- Products used for rental purposes.

SEATING USAGE

Normal commercial use for seating is identified as the equivalent of a single shift, forty-(40) hour workweek. To the extent that a seating product is used in a manner exceeding this, the applicable warranty period will be reduced in a pro-rata manner.

A WORD ABOUT COLOR VARIATIONS, FABRICS AND FINISHES:

The HON Company does not warrant the color-fastness or matching of colors, grains or textures of covering materials.

CUSTOMER'S OWN MATERIAL (COM)

Not available on HON products covered under the HON 5-year warranty.

TO THE EXTENT ALLOWED BY LAW, THE HON COMPANY MAKES NO OTHER WARRANTY, EITHER EXPRESS OR IMPLIED, INCLUDING ANY WARRANTY OF MERCHANTABILITY OR FITNESS FOR A PARTICULAR PURPOSE. THE HON COMPANY WILL NOT BE LIABLE FOR ANY CONSEQUENTIAL OR INCIDENTAL DAMAGES.

NOTICE TO PURCHASERS FOR HOME OR PERSONAL USE:

Federal law does not permit the exclusion of certain implied warranties for consumer products. Therefore, if you are purchasing this product for home or personal use, the exclusion of implied warranties noted in the above paragraph does not apply to you. Some states do not allow the exclusion or limitation of incidental or consequential damages, so the above limitation or exclusion may not apply to you. This warranty gives you specific legal rights, and you may also have other rights which vary from state to state.

This warranty applies only to products sold within the United States of America and the Commonwealth of Canada.

TO OBTAIN SERVICE UNDER THIS WARRANTY:

Your HON® Dealer is our mutual partner in supporting your warranty requests. By following the procedures outlined below, you can be assured of the best level of service. Please note: Consent of The HON Company must be obtained before any warranty work is performed. To obtain consent, please take the following steps:

1. Contact the Dealer from whom the product was purchased within 30 days of discovery of the defect. Be prepared to affirm that you are the original purchaser of the product and to provide the serial number(s) from the product in question.
2. Your Dealer will gather all pertinent information regarding the claim, inspect the product and contact a HON Company customer service representative. (Please allow a reasonable amount of time for inspection and review.)
3. If The HON Company affirms that the product in question is eligible under the conditions of the warranty as stated above, the customer service representative or another representative of the Company will determine whether to provide replacement parts, authorize repairs or replace the product.

ORDERING INFORMATION

ORDERING

Electronic ordering is the standard order process for HON. HON supports the following primary methods for the electronic transmission of orders and order related documents:

Electronic Ordering

Available in the HONReady portal at honready.hon.com. There are multiple options available for processing orders electronically.

Integration with the standard Office Furniture business systems or other pre-approved proprietary software packages.

SIF file upload using fully optioned SIF files into the electronic ordering applications.

Manual entry of line items into the electronic ordering application.

EDI-System to System Integration

With standard Office Product systems or other pre-approved proprietary software systems.

Training, technical set-up and support is available through our Dealer Operations Team at honready@honcompany.com.

ORDER REQUIREMENTS

- Customer must provide complete and correct information, including complete model number, finishes, colors, options, and quantity.
- If a bid quotation or other special pricing applies, such information must be clearly stated on the order with applicable bid number or contract number.
- Order Management contact name and phone number.
- Delivery Appointment contact name and phone number at the dealership or installation company. HON does not accept orders with end user appointment contacts.
- Dealer Sales Representative, primary or multiple DSRs.
- “Best Date Available” for the entire order is standard service for HON. If eligible, other Date Requests may be requested and must be submitted with the order. Other Date Requests are subject to review by HON prior to acceptance:
 - “Ship After” requests are eligible on all order sizes
 - “Deliver On” requests are eligible for full truckload orders
- Additional services outside of HON’s standard services may be available through HON’s ‘Enhanced Services’ for a corresponding fee. Requested services from ‘Enhanced Services’ must be provided at time of order placement.
- The Company reserves the right to require electronic orders or charge \$50 fee per Purchase Order (PO) for manual order processing.
- Failure to provide complete and accurate information results in delayed order entry and acknowledgment. Incomplete orders will not be produced and will be returned to Dealer for correction.

ACKNOWLEDGMENT SERVICE

- E-mailed acknowledgments are available by customer request.
- An acknowledgment will be emailed the morning of the next business day, unless order is placed on credit or other order hold.
- The order will not receive an acknowledged shipment date until all order holds are released.

ORDER CHANGES OR CANCELLATIONS

For Order Changes or Cancellations, please contact Customer Support at 800-833-3964.

TERMS AND CONDITIONS

See **HON NOW** on honready.hon.com for more information about HON NOW delivery, services and ordering information.

INTEGRATED DESIGN SOLUTIONS

HON INTEGRATED DESIGN SOLUTIONS

Need design assistance? We can help! Our expert design staff will create a professional design package that is sure to put you one step ahead of the competition. And the best part is – it's free!

AUDIT

We will check your drawing and parts list for accuracy. We verify quantity, specification accuracy, product compatibility and structural support.

PLAN & SPECIFY

We will provide a professional design package including a CAD furniture plan, 3-D line drawing and complete parts list based on the rough sketch and work order forms you supply.

VALUE ENGINEERING

We will optimize workstation layouts and propose potential cost saving measures to help your customer save money and make you more competitive and profitable.

RENDERING

We will create a photo realistic rendering of your furniture plan to help your customer visualize what their desired office space will look like.

*SPACE PLANNING (BILLABLE SERVICE)

Let our team do the creative work for you. Our low rates and expert staff will create a furniture layout and design that best suits your customer.

PLANNING TYPICALS

Quick planning ideas to share with your clients. Various settings showcasing desks, tables and workstations available in multiple formats. View them today under Design Resources on the HON Ready Portal.

CONTACT INTEGRATED DESIGN SOLUTIONS

Questions? Please reach out to your region's dedicated designer. Not sure how to reach your designer? Send us a note at the email below.

E-Mail: integrateddesign@honcompany.com



Solve® Chair shown with Coordinate™ Height Adjustable Table.

Project Space

A place for all HON Project Services

Project Space provides one platform to access the full portfolio of HON services including:

- Plan & Specify
- Audit
- Product Modification
- Special Laminates
- Value Engineering
- Rendering
- Customer's Own Material
- Dual Fabric Applications
- Space Planning
- Special Paints
- Project Bid Pricing

Submit your request on the Community powered by HNI, Projects.

Project Space Lead Time: 1-3 business days depending on complexity and size of your project.

TAILORED SOLUTIONS ORDERING INFORMATION

PRODUCT MODIFICATIONS

Modifications include structural and dimensional modifications to existing product and Dual Fabric Applications, when standard model is not available.

The HON Company, at its own discretion, may modify standard products to meet specific needs. Product specials can be requested on HON brand product only.

List prices contained in published list pricers are for standard catalog items only. Changes or alterations to catalog items other than those listed as catalog options are subject to additional charges. Pricing will only be furnished upon approval of the special request.

Requests to have the product produced in more than one fabric (e.g., fabric on the seat is different than the fabric on the back), are considered a Dual Fabric Applications request and follow the Product Modification request process within MyProjects.

SPECIAL LAMINATES

Special laminates include requests for laminates not available as part of The HON Company's standard offering. Requests for special laminates are subject to manufacturing approval and minimum order quantities. The HON Company approved special laminates will be subject to a designated upcharge per unit.

Requests for special laminates should be submitted through the MyProjects Application on the HON Ready portal. Pricing will only be furnished upon approval of the special request.

SPECIAL PAINTS

- The HON Company's paint matching equipment can match almost any color, excluding some metallic and whites.
- Special paint requests must be submitted on the HON Ready Portal MyProjects application.
- In order to request a paint sample, the customer must have a minimum order of 10 like product units. Any requests with less than that amount will not be processed.
 - For each new paint request, there will be a \$500 net charge. A sample of the exact color desired is required for matching and approval. The HON Company will match the color and provide a production sample for the customer to review and approve.

- Once the signed paint sample is received at The HON Company, the request will be approved.
- Each unique color or finish combination incurs a designated upcharge per color per order (all standard discounts/competitive project pricing applies).

Special note: Some special colors could fall outside of this program due to production costs or not meeting The HON Company's quality standards. The HON Company may apply additional charges to some colors which are costly to apply, and refuse some orders on colors that cannot meet The HON Company's high-quality standards. The HON Company will notify the customer upon completion of The HON Company's evaluation if a change in price is required or rejection of the order.

DISCONTINUED PRODUCT

Requests for discontinued product require engineering evaluation, safety review, and testing to current standards prior to approval. Many discontinued products are not available for order. Requests for discontinued products should be submitted through the MyProjects Application on the HON Ready portal.

LEAD TIMES FOR SPECIALS PRODUCT

Lead times on orders containing specials are subject to production capacity and material availability. When possible, the customer should order special products separately to avoid extended lead times for standard products. Extended lead times will be noted on the specials request.

CHANGES TO SPECIALS PRODUCT

A special model will be provided for each approved special item to process orders. Once an order is placed, no changes or cancellations can be made to the order without approval from Tailored Solutions.

CONTACT TAILORED SOLUTIONS

Phone: 800.833.3964 and listen for Tailored Solutions offering on the menu.

Email: HONSpecials@honcompany.com

CUSTOMER'S OWN MATERIAL ORDERING INFORMATION

CUSTOMER'S OWN MATERIAL (COM) PROGRAM

Customer's Own Material (COM) is a request to use fabrics not available as part of HON's standard fabric offering. Manufacture to Supply (MTS) and Dealer to Supply (DTS) are the two ordering methods. The HON Company has partnered with fabric manufacturers to provide competitive pricing and selection through the MTS program. MTS will be the standard offering unless The HON Company is unable to procure the fabric. If there is a DTS request submitted, The HON Company will advise at the time of the request if DTS is available.

CUSTOMER WARRANTY EXCLUSION

The HON Company shall have no responsibility for the condition, quality, value, performance, physical properties, or any other aspects of the COM.

The HON Company shall have no liability for any damages, injuries, or losses to the customer or to any third party that shall be caused by any COM or product modification, and the customer shall hold The HON Company harmless for all liability.

The HON Company assumes no responsibility for the overall appearance, flammability, normal durability, colorfastness, or any other quality of the COM or product modification after its application on a HON product beyond normal quality standards. The HON Company reserves the right to reject a COM fabric if the quality of the COM is not satisfactory for the product. Should this occur, the customer will be notified with an explanation of the issue.

The HON Company is not responsible for fabric that has become obsolete at the COM supplier, that is of poor quality, or that is delivered late to The HON Company from the COM supplier. The HON Company is not responsible for excess yardage created by DTS orders and reserves the right to dispose of the excess fabric.

As a standard HON does not pattern match any standard, partnership or COM fabric, therefore pattern match is not applicable under warranty. If pattern match is needed please submit a Tailored Solutions request or contact HON Customer Support/Tailored Solutions once your COM has been approved.

COM TESTING

As a result of recent legal requirements, The HON Company will need to obtain specific information from the fabric supplier about treatments and chemicals used in the fabric. To the extent the supplier is unwilling or unable to provide the necessary information, which could extend the testing lead time of the request.

To check if a COM has been tested previously, utilize the COM Search Tool on the HON Ready Portal > Design Resources > Textiles & Finishes section using the following information:

- COM Supplier's Name
- Fabric Pattern Name
- Color Name
- If the COM fabric has been tested and previously approved, the COM will not need to be re-tested unless testing standards have changed, fabric is to be used on a different series, or direction of the fabric has changed from what was previously approved. Please note that Panel product must be approved for each model and color.
- If the pattern has previously been tested and approved, but not in the specific requested color, the customer will need to request an order code for that color only. No further testing will be necessary since the pattern has already been approved.

If the fabric has not previously been tested, the customer must enter the COM request on the HON Ready Portal > Textiles & Finishes > COM Search Tool.

Complete the Supplier Name, Pattern, and Color drop-down fields. For quicker results in these fields, type the first letter of the (supplier, pattern, color) name and, when done, click Add and then Submit. (Multiple series can be added to the same request if they are the same supplier, pattern, and color.)

An email will be sent to the requestor stating the COM Request was successfully submitted. Up to four emails could be received: submitted, in testing, testing materials requested, and final approval/denial with price grade and fabric code. The testing process takes approximately 48 hours.

COM yardage in the pricer is shown as pattern cut only.

COM TESTING — FLAMMABILITY TESTING INFORMATION

The customer is responsible for ensuring that the COM fabric is certified to meet all flame-retardant requirements. All COM seating fabric must, at minimum, meet CAL 117 requirements. If the customer requires the chair be tested to meet the fire safety standards of CAL 133, additional testing and information is required.

MTS COM

As previously mentioned, MTS is the primary COM method.

If the COM fabric has not been tested, a COM request must be submitted on the HON Ready Portal.

For MTS orders, The HON Company will procure fabric needed for production. Should The HON Company not be able to obtain fabric yardage, the customer will be contacted.

CUSTOMER'S OWN MATERIAL ORDERING INFORMATION

When testing has been completed, the customer will be notified by the COM team of the test results. If the COM is approved, The HON Company will provide a COM tracking order code for MTS. That tracking code is required on the order in place of the standard fabric code.

If approved, MTS product will be assigned an appropriate fabric grade for pricing. The pricing can be found on the HON Ready Portal > Design Resources > Textiles & Finishes. (All standard discounts/competitive project pricing applies).

Written COM price quotes are valid for 90 days after the issue date.

DTS COM

DTS COM is only available if the COM fabric cannot be procured by The HON Company. If the fabric can be procured by The HON Company, the customer will be contacted to switch to MTS or cancel the request.

If your fabric is not listed as approved, and it is not a Partnership fabric you may request a "Dealer to Supply" code. Select the "Request COM Test" link on the COM Search website. Complete the Supplier Name, Pattern, and Color drop-down fields. For quicker results in these fields, type the first letter of the (supplier, pattern, color) name and, when done, click Add and then Submit. (Multiple series can be added to the same request if they are the same supplier, pattern, and color.)

An email will be sent to the requestor stating the COM Request was successfully submitted. Up to four emails could be received: submitted, in testing, testing materials requested, and final approval/denial with price grade and fabric code. It's rare actual test yardage is required. Testing is mainly done by reviewing the attributes of the fabric. The testing process takes approximately 48 hours.

If the COM has not been tested, a COM request must be submitted on the HON Ready Portal > Design Resources > Textiles & Finishes.

When testing has been completed, the customer will be notified by the COM team of the test results. If the COM is approved, The HON Company will provide a COM tracking order code. That tracking code is required on the order in the place of the standard fabric code.

DTS product is priced at the following grades (all standard discounts/competitive project pricing applies):

- Chairs are a Grade 4
- Panel product is a Grade D

Written COM price quotes are valid for 90 days after the issue date.

COM LEAD TIME

Ship dates will be based on fabric receipt and The HON Company's standard lead time. All fabric must be properly tagged and shipped to the appropriate producing location (provided in the approval email).

- Specific to DTS orders, COM orders will not receive a ship (acknowledged) date until The HON Company has the fabric in its possession for production.
- Specific to DTS orders, the customer may send the required yardage for the order to the address listed on the approval email to arrive no sooner than 4 weeks in advance of the acknowledgment date.

HON will make every effort to locate mis-directed COM shipments on behalf of the customer. However, The HON Company will not be responsible for any COM received without a tracking number or incorrectly shipped by the fabric vendor to an incorrect producing facility.

COM ORDERING INFORMATION

The following information must appear on or accompany the product purchase order:

- Approval tracking number and the customer's purchase order number
- COM supplier, pattern, and color name/number

The packing list for the COM must include the following information when The HON Company receives the shipment for production:

- Dealer or Wholesaler Name
- Purchase order number submitted to The HON Company
- Fabric name
- Yardage shipped
- Approval ordering code

If The HON Company receives fabric with incorrect labeling that cannot be linked to an order, The HON Company will hold the fabric for up to 7 days while the COM team attempts to identify the order. After 7 days, The HON Company will return the fabric to the sender.

Specific to DTS orders; the customer should send only the amount needed for the order. Excess yardage will be disposed of at The HON Company's discretion.

CHANGES TO COM PRODUCT

Once a COM product is ordered, no changes or cancellations can be made to the COM product without approval from the HON COM team.

CONTACT COM TEAM

Phone: 800.833.3964 and listen for COM TEAM offering on the menu.

COM Email: HONCOMTeam@honcompany.com

PARTNERSHIP TEXTILE INFORMATION

Partnership Textiles is the result of The HON Company's partnership with textile industry leaders Camira, HBF Textiles, Maharam, Stinson, and Ultrafabrics, LLC. The extensive collection of design-driven textiles create a superior offering at a great value. Partnership Textiles significantly updates HON's offering, expanding it with fresh and exciting options.

- **Fabric Warranty:** Partnership Textiles are covered by HON's Full Lifetime Warranty.
- **Lead Times:** Orders specified with Partnership Textiles will be acknowledged based on the supplier's availability and delivery schedule.
- **Availability:** The HON Company will regularly introduce new Partnership Textiles and reserves the right to change the offering at any time.
- **Fabric Cards:** A curated set of Partnership Textiles are carded jointly by HON and the supplier.

Camira

- Blazer

HBF Textiles*

- Everyday Textures

*HBF Textiles patterns are graded in to HON's offering.

Maharam

- Apt
- Bluff
- Collection 1
- Lariat
- Meld
- 6M

Stinson

- Edge
- Elevate
- Flow II
- Reliance IV

Ultrafabrics, LLC

- Brisa
- Ultraleather Pro

Fabric Memo Samples: Please contact the supplier directly:

Camira: memos@camirafabrics.com

HBF Textiles: Phone: +1 (877) 494-5727, orders@hbftextiles.com

Maharam: (800) 645-3943

Stinson: (800) 841-6279

Ultrafabrics: (877) 309-6648

HON BRANDED, PARTNERSHIP AND COM PATTERN MATCH

- **Pattern matching** provides alignment of patterns or stripes across individual chair surfaces. Additional yardage may be required depending on pattern repeat. If Pattern Match is needed, please contact HON Customer Support/Tailored Solutions.
- **Chair to Chair Pattern Match** provides identical pattern alignment from unit to unit and is available with an upcharge. Chair to Chair Pattern Match is reviewed on a case by case basis as several factors are reviewed to determine additional yardage required, including repeat and pattern direction. If Chair to Chair Pattern Match is needed, please contact HON Customer Support/Tailored Solutions.



PAINT PROGRAM

The HON Company has established paint grades to allow customers flexibility and ease in doing business with HON. HON has three paint grades P1, P2, and P3.

P1 PAINT COLORS

HON has established P1 paints which are available on a majority of core products.

P2 PAINT COLORS

Please see individual pricer pages for eligible series and upcharges for P2 paints. P2 paints are listed in the pricer pages under the column P2. Upcharges vary by product (all standard discounts/competitive project pricing applies). No minimum quantity required.

P3 PAINT COLORS

Please see individual pricer pages for eligible series and upcharges for P3 paints. P3 paints are listed in the pricer pages under the column P3. Upcharges vary by product (all standard discounts/competitive project pricing applies). No minimum quantity required.

SPECIAL PAINT COLORS (P4-P6)

With The HON Company's state of the art color matching equipment just about any color can be matched, excluding some metallic and whites. A sample of the exact color desired is required for matching and approval.

- For each newly requested paint, a net fee of \$500 will be charged to cover costs associated with the matching process.
- For existing, previously matched paints, there is no matching fee, however there is a \$100 net fee for sample panels required for the approval process. Refer to MyProjects on the HON Portal for a list of approved special paints.

For all special paint requests, HON will send a production sample for the customer to review and approve. Once the signed paint sample is received at HON the order can be entered. Upcharges vary by product (all standard discounts/competitive project pricing applies). A quantity of 10 like-model minimum order is required for special paints. For complete program details, access Tailored Solutions on the HON Ready Portal at honready.hon.com.

Some special colors could fall outside of this program due to production costs or not meeting HON quality standards. The HON Company may apply additional charges to some colors which are costly to apply, and deny some orders on colors that cannot meet our high-quality standards. We will notify the customer upon completion of our evaluation if a change in price is required or if the request is denied.

ENVIRONMENTAL STATEMENT

We continually reevaluate our purpose and processes, from fostering transparency and circularity in our supply chain to empowering our members to do and be better. We do it so the environments you create will be safer, more socially responsible, and more sustainable.

We've pursued product certifications to help communicate our commitment to developing sustainable products.

Clearing the air.

In 2006, The HON Company became one of the first office furniture manufacturer to have products certified under the Indoor Advantage™ program. Virtually all manufactured products emit chemical compounds into the air. Indoor Advantage™ certification helps assure customers that certified products will help improve the air quality within their offices and workspaces.

Developed by SCS Global Services, Indoor Advantage™ evaluates products against indoor air quality standards, like ANSI/BIFMA Furniture Emissions Standard, X7.1 and CDPH. The ANSI/BIFMA X7.1 standard allows manufacturers to test individual components, as well as complete products for emissions from volatile organic compounds (VOCs). This allows us to identify problematic materials and phase them out of our products.

Indoor Advantage™ certified products meet the LEED and WELL criteria for low-emitting materials.

Indoor Advantage™ offers two levels of certification, including Indoor Advantage™ and Indoor Advantage™ Gold.



On the LEVEL®.

LEVEL®, the certification program for the BIFMA e3 Sustainability Standard, was developed in response to increasing demand for proof that manufacturers were living up to their environmental claims. LEVEL® is a multi-attribute sustainability certification label for products that have met criteria in four categories of impact: Materials, Energy and Atmosphere, Human and Ecosystem Health, and Social Responsibility.

HON's products are certified to LEVEL 2 and LEVEL 3, the highest achievement.



Evaluating Our Impacts.

HON has begun studying the impacts our products have on the environment through lifecycle assessments and creating Environmental Product Declarations (EPDs). EPDs provide an understandable report of how a product impacts natural resources, the environment, and the atmosphere throughout its lifecycle.

Products that meet these specifications are identified throughout this publication with the following icons:

Certified SCS Indoor Advantage™

LEVEL® certified to the BIFMA e3 Sustainability Standard

Environmental Product Declarations



IMPORTANT INFORMATION

HON NOW™

SUPERIOR OFFICE SOLUTIONS AT THE SPEED YOU NEED

To keep your business at peak productivity, waiting is not always an option. The HON NOW™ Quickship program was designed for movers and shakers like you who want exceptional quality, durability, and versatility without compromising valuable time. Whether you're outfitting a brand new workspace or simply expanding the one you already have, we've got a variety of dependable and supportive office furniture solutions designed to fit your needs and your schedule — in a hurry, without the hassle.

To learn more, visit hon.to/now.

GSA CONTRACT INFORMATION

Model numbers identified with the verbiage “**Open Market**” are not offered on HON's GSA contract GS-27F-0015S. Model numbers identified with the following verbiage “Must be purchased with a configurable end product. If ordered separately, not on GSA contract” is to mean that these configurable components or options:

- Have no functionality or capability without being integrated into an end product, and
- Are not separately orderable; an eligible Schedule ordering activity may only purchase them with a configured system that is on contract.

HON CUSTOMER SUPPORT CONTACT INFORMATION

Nationwide CS Phone – (800) 833-3964

Nationwide CS Email – HONTeamBox@honcompany.com

Nationwide Order Entry – email: HONOE@honcompany.com

Government CS Phone – (800) 466-8694

GSA Team: HONGSATEAM@honcompany.com

GSA Order Entry: HONGSAOE@honcompany.com

Integrated Design Solutions – integrateddesign@honcompany.com

Online Order and Tool Support – HONReady@honcompany.com

DASH (transportation and delivery assistance) – (800) 334-8057

HON Literature Fulfillment Phone – (800) 466-4808



Nationwide CS Phone

800-833-3964

THE FOLLOWING ICONS MAY BE USED THROUGHOUT THIS PUBLICATION

| | | | |
|---|--|---|--|
|  | Meets or exceeds ANSI/BIFMA and ISTA performance standards |  | Readily Available. For additional lead time information see page 21. |
|  | Certified SCS Indoor Advantage™ See page 17 for more details. |  | Available within a “standard” or “extended” lead time. For additional lead time information see page 21. |
|  | Complies to the BIFMA e3 Sustainability Standard. See page 17 for more details. |  | May have extended lead times. For additional lead time information see page 21. |
|  | Caution |  | Product shipped two to a carton |
|  | Easy to assemble |  | Product shipped four to a carton |
|  | Shippable by small-package carrier |  | Fire Code |
|  | Wheel-chair compatible |  | Core Product Line |
|  | Soft-tread caster option available |  | ColorCorrect® Eligible Product |
|  | HON “One Key” Interchangeable core removable locks (see page 773) |  | Product scheduled for discontinuation |
|  | Omit core removable lock option available. Allows keyed alike workstations (see page 773). |  | DE-EMPHASIZED: Product or fabric/surface material is de-emphasized, effective date as noted. Not carded. View online at honready.hon.com |
|  | Base models available on the HON NOW Quickship Program with select options and finishes. View the entire NOW collection at honready.hon.com . |  | Warranted for multiple shift use, 24 hours a day 7 days a week |

FABRIC PATTERNS & CODES



FABRIC PATTERNS & CODES

- For additional HON to Supply COM fabric grade pricing, go to honready.hon.com and search on the HON to Supply COM link.
 - All specifications in this publication are based on the latest product information available at the time of print.
 - Certain dyes (including clothing and accessory dyes such as those used on denim jeans) may migrate to lighter colors. This phenomenon is increased by humidity and temperature and is irreversible. The HON Company LLC does not assume responsibility for dye transfer caused by external contaminants.
 - COM Ordering Information and pricing on page 14.
 - See page 15 for Partnership Textile program information.
 - All standard fabrics are carded. Cards are available through HON Literature Fulfillment.
 - Fabrics and foam meet requirements for CAL-TB 117-2013.
- ! Different fabrics and finishes have different recommended cleaning and maintenance methods. For the correct product care for all finishes view the HON Product Care guide at hon.com/customer-support/product-care.

LEAD TIMES

THE FOLLOWING ICONS ARE USED TO DENOTE FABRIC OPTION LEAD TIMES

FABRIC/FINISH LEAD TIME INDICATOR



Fabric is readily available. Products using these fabrics will receive the best available product lead time and are a good option for standards programs as they will be in the HON portfolio for several years. Go to honready.hon.com and use **Compass** for product lead times by series.



Fabric is available within standard lead times. Products using these fabrics will receive a “standard” or “extended” lead time. The lead time will be determined by the combination of product and fabric. Go to honready.hon.com and use **Compass** for product lead times by series.



Fabric may have extended lead times. Products using these fabrics will typically have a 4+ week lead time. Go to honready.hon.com and use the **Compass** tool for product lead times by series.

HON EXPRESS QUICK SHIP PROGRAM

For the full list of products delivered in 5 business days or less, visit honready.hon.com.

PRODUCT LEAD TIMES

Standard lead times for products are between 2-4 weeks. For current exceptions to our standard lead time, go to honready.hon.com and use the **Compass** tool.

In order to establish accurate expectations for your project, please review this listing prior to submitting your purchase order.

Lead time calculation begins when order is free from any holds (i.e., bad lines, material, credit, etc.).

Please note, these production lead time estimates do NOT include delivery time. All published lead times are estimates, not guarantees of delivery.

For further information concerning lead times, please contact HON Customer Support via email HONTeamBox@honcompany or by phone at **800-833-3964**.

FABRIC PATTERNS & CODES

GRADE 1

| APEX | APX |
|--------------|-------|
| ◆ Basalt | APX25 |
| ◆ Beet | APX12 |
| ◆ Blackberry | APX20 |
| ◆ Chive | APX05 |
| ◆ Iris | APX03 |
| ◆ Kiwi | APX06 |
| ◆ Lemonade | APX08 |
| ◆ Navy | APX13 |
| ◆ Papaya | APX09 |
| ◆ Pumice | APX23 |
| ◆ Rain | APX19 |
| ◆ Resort | APX15 |
| ◆ Royal | APX14 |
| ◆ Tiki | APX29 |
| ◆ Tomato | APX11 |

ATTIRE AI

| | |
|-----------------|------|
| ◆ Blaze * | AI42 |
| ◆ Blue Lagoon * | AI90 |
| ◆ Crimson * | AI62 |
| ◆ Fatigue * | AI76 |
| ◆ Ivy * | AI82 |
| ◆ Lithium * | AI19 |
| ◆ Onyx * | AI10 |
| ◆ Sable * | AI49 |
| ◆ Taupe * | AI26 |
| ◆ Turquoise * | AI96 |

BLACK FABRIC ACCF

| | |
|---------|--------|
| ◆ Black | ACCF10 |
|---------|--------|

BLACK MESH ACCM

| | |
|---------|--------|
| ◆ Black | ACCM10 |
|---------|--------|

CENTURION CU

| | |
|-------------|------|
| ◆ Apricot | CU47 |
| ◆ Bark | CU25 |
| ◆ Black | CU10 |
| ◆ Espresso | CU49 |
| ◆ Fog | CU03 |
| ◆ Frost | CU22 |
| ◆ Goldenrod | CU27 |
| ◆ Indigo | CU06 |
| ◆ Iris | CU50 |
| ◆ Iron Ore | CU19 |
| ◆ Jade | CU83 |
| ◆ Marsala | CU63 |
| ◆ Morel | CU24 |
| ◆ Navy | CU98 |
| ◆ Peacock | CU97 |
| ◆ Pear | CU84 |
| ◆ Ruby | CU67 |
| ◆ Sapphire | CU09 |

GRADE 1 *continued*

| COMPASS | COMP |
|---------------|--------|
| ◆ Beach | COMP16 |
| ◆ Bittersweet | COMP46 |
| ◆ Chocolate | COMP49 |
| ◆ Ink | COMP10 |
| ◆ Meadow | COMP82 |
| ◆ Midnight | COMP90 |
| ◆ Putty | COMP22 |
| ◆ Ruby | COMP62 |
| ◆ Sterling | COMP19 |
| ◆ Taupe | COMP26 |
| ◆ Tide | COMP96 |

COMPASS FOAM* COMF

| | |
|---------------|--------|
| ◆ Bittersweet | COMF46 |
| ◆ Ink | COMF10 |
| ◆ Meadow | COMF82 |
| ◆ Midnight | COMF90 |
| ◆ Putty | COMF22 |
| ◆ Sterling | COMF19 |

**This fabric available for Solve* Upholstered Back models only.*

CONTOURETT UR

| | |
|---------------|------|
| ◆ Baltic | UR94 |
| ◆ Beach | UR23 |
| ◆ Black | UR10 |
| ◆ Bordeaux | UR63 |
| ◆ Buff | UR22 |
| ◆ Cloud | UR18 |
| ◆ Coffee Bean | UR49 |
| ◆ Crater | UR51 |
| ◆ Flame | UR62 |
| ◆ Graphite | UR19 |
| ◆ Iron | UR20 |
| ◆ Luggage | UR26 |
| ◆ Marine | UR92 |
| ◆ Navy | UR95 |
| ◆ Nimbus | UR93 |
| ◆ Ocean | UR96 |
| ◆ Pumpkin | UR42 |
| ◆ Quarry | UR24 |
| ◆ Red | UR64 |
| ◆ Safari | UR27 |
| ◆ Sage | UR82 |
| ◆ Steel | UR21 |
| ◆ Storm | UR17 |
| ◆ Taupe | UR28 |
| ◆ Trunk | UR50 |

GRADE 1 *continued*

| DAPPER | DAPR |
|--------------|--------|
| ◆ Ash | DAPR20 |
| ◆ Azalea * | DAPR95 |
| ◆ Breeze | DAPR06 |
| ◆ Canvas | DAPR25 |
| ◆ Charcoal | DAPR01 |
| ◆ Clover | DAPR22 |
| ◆ Currant | DAPR00 |
| ◆ Emerald * | DAPR75 |
| ◆ Fawn | DAPR35 |
| ◆ Fern | DAPR85 |
| ◆ Gerbera | DAPR16 |
| ◆ Grape | DAPR33 |
| ◆ Jewel | DAPR08 |
| ◆ Marigold | DAPR65 |
| ◆ Onyx | DAPR10 |
| ◆ Orchid | DAPR90 |
| ◆ Parrot | DAPR59 |
| ◆ Peony * | DAPR50 |
| ◆ Pool * | DAPR05 |
| ◆ Poppy | DAPR19 |
| ◆ Rose * | DAPR40 |
| ◆ Sapphire | DAPR07 |
| ◆ Scarlet | DAPR45 |
| ◆ Sepia | DAPR30 |
| ◆ Sky | DAPR44 |
| ◆ Slate | DAPR15 |
| ◆ Sorbet | DAPR55 |
| ◆ Spice * | DAPR60 |
| ◆ Spring | DAPR80 |
| ◆ Terracotta | DAPR13 |
| ◆ Titanium | DAPR17 |
| ◆ Varsity | DAPR09 |
| ◆ Zest | DAPR70 |

ENSEMBLE ENSB

| | |
|--------------|--------|
| ◆ Aquamarine | ENSB30 |
| ◆ Ash | ENSB39 |
| ◆ Greige | ENSB36 |
| ◆ Harbor | ENSB34 |
| ◆ Navy | ENSB35 |
| ◆ Oat | ENSB37 |
| ◆ Pear | ENSB33 |
| ◆ Sand | ENSB38 |
| ◆ Scarlet | ENSB32 |
| ◆ Slate | ENSB31 |
| ◆ Stone | ENSB40 |

GRADE 1 *continued*

| HAMILTON | HAML |
|-----------------|--------|
| ◆ Azure | HAML10 |
| ◆ Biscotti | HAML11 |
| ◆ Cabernet | HAML08 |
| ◆ Carolina | HAML21 |
| ◆ Charcoal | HAML17 |
| ◆ Chocolate | HAML13 |
| ◆ Cloud | HAML18 |
| ◆ Dane | HAML16 |
| ◆ Dusty Rose | HAML07 |
| ◆ Esmeralda | HAML06 |
| ◆ Fern | HAML04 |
| ◆ Fresh | HAML03 |
| ◆ Granola | HAML19 |
| ◆ Lilac | HAML14 |
| ◆ Lime | HAML05 |
| ◆ Lipstick | HAML09 |
| ◆ Oxford | HAML20 |
| ◆ Passion Fruit | HAML02 |
| ◆ Pepper | HAML15 |
| ◆ Powder | HAML12 |
| ◆ Sunrise | HAML01 |

INERTIA NR

| | |
|------------|------|
| ◆ Amethyst | NR61 |
| ◆ Calypso | NR98 |
| ◆ Cherry | NR66 |
| ◆ Cobalt | NR91 |
| ◆ Coffee | NR49 |
| ◆ Fog | NR19 |
| ◆ Fuchsia | NR63 |
| ◆ Gecko | NR76 |
| ◆ Glow | NR27 |
| ◆ Leaf | NR75 |
| ◆ Lime | NR82 |
| ◆ Loft | NR22 |
| ◆ Mandarin | NR47 |
| ◆ Meteor | NR30 |
| ◆ Mustard | NR26 |
| ◆ Nickel | NR23 |
| ◆ Onyx | NR10 |
| ◆ Regatta | NR90 |
| ◆ Shadow | NR20 |
| ◆ Surf | NR96 |
| ◆ Tangelo | NR46 |

OPTIC OP

| | |
|----------------|------|
| ◆ Aurora | OP72 |
| ◆ Bark | OP24 |
| ◆ Canopy | OP84 |
| ◆ Char | OP49 |
| ◆ Ruby | OP42 |
| ◆ Sand | OP17 |
| ◆ Sky | OP83 |
| ◆ Slate | OP19 |
| ◆ Sprout | OP74 |
| ◆ Starry Night | OP11 |
| ◆ Storm | OP56 |
| ◆ Wildfire | OP66 |

* Fabric is de-emphasized.

FABRIC PATTERNS & CODES

| GRADE 1 <i>continued</i> | | GRADE 2 | | GRADE 2 <i>continued</i> | | GRADE 2 <i>continued</i> | |
|--------------------------|-------------|------------------------|-------------|--------------------------|-------------|--------------------------|-------------|
| PEBBLE | PBLE | APPOINT SEATING | PNS | DOTTY | DOT | SPIN SEATING | SPNN |
| ◆ Amber | PBLE01 | ◆ Artichoke | PNS014 | ◆ Candy | DOT63 | ◆ Alabaster | SPNN02 |
| ◆ Chalk | PBLE02 | ◆ Blackberry | PNS012 | ◆ Gelato | DOT34 | ◆ Cavern | SPNN03 |
| ◆ Coal | PBLE03 | ◆ Bronze | PNS002 | ◆ Indigo | DOT31 | ◆ Cobblestone | SPNN04 |
| ◆ Gravel | PBLE04 | ◆ Carbon | PNS008 | ◆ Onyx | DOT35 | ◆ Ember | SPNN06 |
| ◆ Magma | PBLE06 | ◆ Chai | PNS013 | ◆ Park | DOT83 | ◆ Flame | SPNN07 |
| ◆ Moss | PBLE05 | ◆ Cherry | PNS010 | ◆ Peat | DOT24 | ◆ Heron | SPNN13 |
| ◆ Sandstone | PBLE07 | ◆ Dark Pewter | PNS017 | ◆ Peony | DOT32 | ◆ Oat | SPNN01 |
| ◆ Talc | PBLE08 | ◆ Dune | PNS015 | ◆ Suit | DOT20 | ◆ Ocean | SPNN12 |
| ◆ Topaz | PBLE09 | ◆ Espresso | PNS003 | ◆ Sunflower | DOT33 | ◆ Plum | SPNN15 |
| ◆ Zircon | PBLE10 | ◆ Framboise | PNS011 | ◆ Tailor | DOT21 | ◆ Pool | SPNN11 |
| | | ◆ Frost | PNS034 | ◆ Tide | DOT90 | ◆ Raven | SPNN10 |
| | | ◆ Jet | PNS007 | ◆ Velum | DOT29 | ◆ Rhubarb | SPNN14 |
| | | ◆ Lawn | PNS005 | ◆ Violet | DOT30 | ◆ Tropic | SPNN08 |
| | | ◆ Mandarin | PNS009 | | | ◆ Willow | SPNN05 |
| | | ◆ Morel | PNS001 | RUSH | RUSH | | |
| | | ◆ Nimbus | PNS016 | ◆ Anchor | RUSH07 | WHISPER VINYL | WP |
| | | ◆ Platinum | PNS004 | ◆ Basil | RUSH16 | ◆ Antelope | WP20 |
| | | ◆ Turquoise | PNS006 | ◆ Blueberry | RUSH10 | ◆ Black | WP40 |
| | | | | ◆ Flamingo | RUSH21 | ◆ Bone | WP17 |
| | | BLUME | BLME | ◆ Greenery | RUSH15 | ◆ Bordeaux | WP26 |
| | | ◆ Chalk | BLME03 | ◆ Greyhound | RUSH06 | ◆ Brick Red | WP99 |
| | | ◆ Char | BLME00 | ◆ Marina | RUSH13 | ◆ Camel | WP18 |
| | | ◆ Coin | BLME02 | ◆ Merlot | RUSH19 | ◆ Cappuccino | WP21 |
| | | ◆ Driftwood | BLME05 | ◆ Midnight | RUSH11 | ◆ Carotene | WP97 |
| | | ◆ Emerald City | BLME07 | ◆ Mint | RUSH09 | ◆ Cashew | WP29 |
| | | ◆ Fir | BLME09 | ◆ Mulberry | RUSH18 | ◆ Cerulean | WP36 |
| | | ◆ Harvest | BLME04 | ◆ Pumice | RUSH01 | ◆ Charcoal | WP39 |
| | | ◆ Haze | BLME08 | ◆ Punch | RUSH20 | ◆ Cinnamon | WP25 |
| | | ◆ Hyacinth | BLME14 | ◆ Sage | RUSH14 | ◆ Cognac | WP62 |
| | | ◆ Jasper | BLME13 | ◆ Salsa | RUSH24 | ◆ Cucumber | WP88 |
| | | ◆ Merlot | BLME10 | ◆ Sand | RUSH05 | ◆ Elephant | WP38 |
| | | ◆ Moonstone | BLME01 | ◆ Seal | RUSH08 | ◆ Espresso | WP49 |
| | | ◆ Opal | BLME06 | ◆ Soot | RUSH02 | ◆ Fawn | WP91 |
| | | ◆ Scarlet | BLME11 | ◆ Stout | RUSH03 | ◆ Fog | WP100 |
| | | ◆ Slate | BLME12 | ◆ Sunshine | RUSH23 | ◆ Forest | WP82 |
| | | | | ◆ Tapestry | RUSH04 | ◆ Gravel | WP19 |
| | | CLYDE | CLYD | ◆ Tiger | RUSH22 | ◆ Indigo | WP86 |
| | | ◆ Antique | CLYD04 | ◆ Vintage | RUSH17 | ◆ Luggage | WP23 |
| | | ◆ Artifact | CLYD01 | ◆ Wave | RUSH12 | ◆ Mahogany | WP93 |
| | | ◆ Blacksmith | CLYD10 | | | ◆ Mallard | WP90 |
| | | ◆ Claret | CLYD13 | SEED | SED | ◆ Merlot | WP27 |
| | | ◆ Craftsman | CLYD08 | ◆ Apple | SED11 | ◆ Molten | WP98 |
| | | ◆ Crate | CLYD12 | ◆ Ash | SED15 | ◆ Navy | WP37 |
| | | ◆ Fossil | CLYD02 | ◆ Cardinal | SED09 | ◆ Ochre | WP96 |
| | | ◆ Heirloom | CLYD05 | ◆ Cinder | SED17 | ◆ Paradise | WP85 |
| | | ◆ Iron | CLYD11 | ◆ Cream | SED12 | ◆ Patina | WP34 |
| | | ◆ Keepsake | CLYD15 | ◆ Driftwood | SED13 | ◆ Pewter | WP83 |
| | | ◆ Linen | CLYD14 | ◆ Harbor | SED10 | ◆ Putty | WP84 |
| | | ◆ Relic | CLYD06 | ◆ Onyx | SED18 | ◆ Salsa | WP42 |
| | | ◆ Seasoned | CLYD03 | ◆ Smoke | SED16 | ◆ Sangre | WP28 |
| | | ◆ Trestle | CLYD07 | ◆ Truffle | SED14 | ◆ Sassafras | WP89 |
| | | | | | | ◆ Storm | WP92 |
| | | | | | | ◆ Truffle | WP95 |
| | | | | | | ◆ Zest | WP87 |

FABRIC PATTERNS & CODES

GRADE 3

| IN SEASON | ISN |
|-------------|--------|
| ◇ Black | ISN001 |
| ◇ Blue Jay | ISN007 |
| ◇ Fire | ISN004 |
| ◇ Jungle | ISN008 |
| ◇ Lake | ISN006 |
| ◇ Lead | ISN002 |
| ◇ Limestone | ISN041 |
| ◇ Ocean | ISN005 |
| ◇ Silver | ISN003 |
| ◇ Smoke | ISN020 |
| ◇ Tundra | ISN011 |

MOXIE

SX

| | |
|--------------|------|
| ◆ Barnwood | SX09 |
| ◆ Basalt | SX23 |
| ◆ Bayou | SX02 |
| ◆ Biscotti | SX08 |
| ◆ Blackberry | SX48 |
| ◆ Blarney | SX49 |
| ◆ Blueberry | SX05 |
| ◆ Bonsai | SX20 |
| ◆ Carob | SX24 |
| ◆ Chalk | SX50 |
| ◆ Chartreuse | SX34 |
| ◆ Cherry | SX38 |
| ◆ Cinnamon | SX13 |
| ◆ Cobalt | SX01 |
| ◆ Coconut | SX06 |
| ◆ Concrete | SX43 |
| ◆ Cumin | SX32 |
| ◆ Dragonfly | SX44 |
| ◆ Earl Grey | SX40 |
| ◆ Elysian | SX04 |
| ◆ Evergreen | SX21 |
| ◆ Fatigue | SX18 |
| ◆ Fawn | SX30 |
| ◆ Flint | SX39 |
| ◆ Hazel | SX31 |
| ◆ Hemp | SX45 |
| ◆ Hickory | SX25 |
| ◆ Holly | SX51 |
| ◆ Jam | SX16 |
| ◆ Kelly | SX33 |
| ◆ Lemongrass | SX19 |
| ◆ Lime | SX41 |
| ◆ Macintosh | SX12 |
| ◆ Mulberry | SX15 |
| ◆ Parchment | SX07 |
| ◆ Peacock | SX03 |
| ◆ Pineapple | SX42 |
| ◆ Plum | SX17 |
| ◆ Punch | SX46 |
| ◆ Riverstone | SX47 |
| ◆ Russet | SX14 |
| ◆ Smokestack | SX22 |
| ◆ Tangerine | SX37 |
| ◆ Terracotta | SX11 |
| ◆ Thicket | SX35 |
| ◆ Walnut | SX10 |

GRADE 3

continued

| PARKER | PRKR |
|-------------|--------|
| ◇ Aloe | PRKR01 |
| ◆ Cumulus | PRKR05 |
| ◆ Cyan | PRKR06 |
| ◆ Domino | PRKR07 |
| ◆ Fossil | PRKR10 |
| ◆ Graphite | PRKR11 |
| ◇ Grass | PRKR12 |
| ◆ Grenadine | PRKR13 |
| ◆ Griffin | PRKR14 |
| ◆ Kiln | PRKR16 |
| ◆ Magnesium | PRKR18 |
| ◆ Magnet | PRKR19 |
| ◆ Mica | PRKR20 |
| ◆ Mink | PRKR21 |
| ◆ Nightfall | PRKR22 |
| ◆ Paprika | PRKR24 |
| ◆ Pine | PRKR25 |
| ◆ Rapids | PRKR28 |
| ◆ Rioja | PRKR30 |

PURL

PURL

| | |
|------------|--------|
| ◇ Alpaca | PURL08 |
| ◇ Braid | PURL10 |
| ◆ Deep | PURL12 |
| ◆ Graze | PURL05 |
| ◆ Loom | PURL06 |
| ◆ Needle | PURL07 |
| ◆ Pasture | PURL02 |
| ◆ Ranch | PURL04 |
| ◆ Shuttle | PURL09 |
| ◆ Skein | PURL01 |
| ◆ Thistle | PURL11 |
| ◆ Yearling | PURL03 |

QUILL

QUL

| | |
|------------|-------|
| ◇ Aviary | QUL03 |
| ◆ Feather | QUL02 |
| ◆ Fountain | QUL06 |
| ◆ Ink | QUL05 |
| ◆ Metal | QUL04 |
| ◆ Reed | QUL08 |
| ◆ Scroll | QUL01 |
| ◆ Well | QUL07 |

GRADE L1

| DENVER LEATHER | SS |
|----------------|------|
| ◆ Black | SS11 |

For a complete list of fabrics, including partnership fabrics, go to hon.com/fabricsandfinishes.

PANEL FABRIC PATTERNS & CODES

| PRICE CODE AA | | PRICE CODE A | | PRICE CODE A <i>continued</i> | | PRICE CODE A <i>continued</i> | |
|---------------|--------|------------------|-----------|-------------------------------|------------|-------------------------------|------------|
| FACTOR | FACT | APPOINT | APN | ETCH* | ECH | REFLECTIONS* | REF |
| ◇ Bark | FACT20 | ◇ Artichoke | APN11 | ◇ Axis | ECH13 | ◇ Galvanized | REF29 |
| ◇ Barley | FACT15 | ◇ Blackberry | APN32 | ◇ Blend | ECH14 | ◇ Ice | REF20 |
| ◇ Cascade | FACT25 | ◇ Bronze | APN22 | ◇ Cast | ECH12 | ◇ Loggia | REF21 |
| ◇ Feather | FACT30 | ◇ Carbon | APN28 | ◇ Highlight | ECH10 | ◇ Mistral | REF28 |
| | | ◇ Chai | APN12 | ◇ Midtone | ECH11 | ◇ Moonstone | REF23 |
| | | ◇ Cherry | APN30 | ◇ Outline | ECH08 | ◇ Pewter | REF22 |
| | | ◇ Dark Pewter | APN17 | ◇ Shade | ECH09 | ◇ Stainless | REF24 |
| | | ◇ Dune | APN15 | ◇ Tonal | ECH16 | ◇ Vanilla | REF25 |
| | | ◇ Espresso | APN23 | ◇ Vanish | ECH15 | ◇ Winter | REF27 |
| | | ◇ Framboise | APN31 | | | | |
| | | ◇ Frost | APN34 | EXCHANGE* | EXG | REFUGE* | RFG |
| | | ◇ Jet | APN27 | ◇ Iron | EXG916 | ◇ Artesian | RFG96 |
| | | ◇ Lawn | APN25 | ◇ Nickel | EXG914 | ◇ Dune | RFG92 |
| | | ◇ Mandarin | APN29 | ◇ Pistachio | EXG910 | ◇ Eclipse | RFG90 |
| | | ◇ Morel | APN09 | ◇ Root | EXG913 | ◇ Frost | RFG93 |
| | | ◇ Nimbus | APN16 | ◇ Rupee | EXG903 | ◇ Glacier | RFG91 |
| | | ◇ Platinum | APN24 | ◇ Shadow | EXG911 | ◇ Mineral | RFG98 |
| | | ◇ Turquoise | APN26 | ◇ Silver | EXG915 | ◇ Tidal | RFG94 |
| | | | | ◇ Sisal | EXG917 | | |
| | | CENTURION | CU | ◇ Stone | EXG912 | SARTO* | SRT |
| | | ◇ Apricot | CU47 | | | ◇ Ash | SRT88 |
| | | ◇ Bark | CU25 | LANDSCAPE* | LN | ◇ Fog | SRT14 |
| | | ◇ Black | CU10 | ◇ Azure | LN55 | ◇ Lemongrass | SRT49 |
| | | ◇ Espresso | CU49 | ◇ Cornsilk | LN15 | ◇ Mist | SRT45 |
| | | ◇ Fog | CU03 | ◇ Drift | LN05 | ◇ Mushroom | SRT76 |
| | | ◇ Frost | CU22 | ◇ Khaki | LN20 | ◇ Oyster | SRT18 |
| | | ◇ Goldenrod | CU27 | ◇ Sheen | LN10 | ◇ Reef | SRT64 |
| | | ◇ Indigo | CU06 | ◇ Slate | LN35 | ◇ Sesame | SRT93 |
| | | ◇ Iris | CU50 | ◇ Umber | LN25 | ◇ Shale | SRT52 |
| | | ◇ Iron Ore | CU19 | ◇ Urban | LN30 | | |
| | | ◇ Jade | CU83 | | | TEMPEST* | TP |
| | | ◇ Marsala | CU63 | LUCY* | LC | ◇ Dragonfly | TP30 |
| | | ◇ Morel | CU24 | ◇ Aspen | LC32 | ◇ Frost | TP15 |
| | | ◇ Navy | CU98 | ◇ Cornsilk | LC30 | ◇ Full Stream | TP80 |
| | | ◇ Peacock | CU97 | ◇ Dusk | LC22 | ◇ Gold Rush | TP10 |
| | | ◇ Pear | CU84 | ◇ Fawn | LC33 | ◇ Slate | TP45 |
| | | ◇ Ruby | CU67 | ◇ Graphite | LC34 | ◇ Tumbleweed | TP70 |
| | | ◇ Sapphire | CU09 | ◇ Mist | LC20 | ◇ Wind Chill | TP40 |
| | | | | ◇ Neutra | LC24 | ◇ Zebra | TP35 |
| | | | | ◇ Pewter | LC35 | | |
| | | | | ◇ Snowdrop | LC28 | | |

NOTES: Centurion fabrics not available on panels that exceed a width and height of 54"H.

Exchange is applied pattern cut and is not available on 78"W tackboards, Voi® screens, and Empower®.

Disperse is applied pattern cut and is not available on 72"W Accelerate® panels and not available on 66"W tackboards, Voi® screens, and Empower®.

◇◇◇ For lead time information see page 19.

* Directional fabrics

PANEL FABRIC PATTERNS & CODES

PRICE CODE B

| ANALOG | ANLG |
|-------------------------------------|--------|
| <i>Not available on Accelerate®</i> | |
| ◆ Album | ANLG06 |
| ◆ Cartridge | ANLG04 |
| ◆ Cassette | ANLG09 |
| ◆ Dial | ANLG02 |
| ◆ Media | ANLG08 |
| ◆ Reel | ANLG07 |
| ◆ Signal | ANLG03 |
| ◆ Stereo | ANLG01 |
| ◆ Track | ANLG05 |

COAST*

| COAST* | COA |
|-------------------------------------|-------|
| <i>Not available on Accelerate®</i> | |
| ◆ Channel | COA14 |
| ◆ Dune | COA03 |
| ◆ Headlands | COA10 |
| ◆ Marsh | COA02 |
| ◆ Pebble | COA12 |
| ◆ Pier | COA13 |
| ◆ Shoal | COA01 |
| ◆ Silt | COA06 |
| ◆ Tide | COA08 |

PRICE CODE B *continued*

| DISPERSE* | DISP |
|----------------|--------|
| ◆ Autumn | DISP03 |
| ◆ Branch | DISP10 |
| ◆ Coffee Bean | DISP13 |
| ◆ Dusk | DISP09 |
| ◆ Emerald City | DISP08 |
| ◆ Gold Rush | DISP02 |
| ◆ Igloo | DISP11 |
| ◆ Ink | DISP06 |
| ◆ Mist | DISP12 |
| ◆ Oatmeal | DISP15 |
| ◆ Prince | DISP07 |
| ◆ Reservoir | DISP01 |
| ◆ Rose | DISP04 |
| ◆ Spring | DISP05 |
| ◆ Steel | DISP16 |
| ◆ Taupe | DISP14 |

MICA*

| MICA* | MCA |
|--------------|--------|
| ◆ Anthracite | MCA11 |
| ◆ Breeze | MCA18 |
| ◆ Bronze | MCA13 |
| ◆ Buff | MCA14 |
| ◆ Cremini | MCA17 |
| ◆ Crystal | MCAWIT |
| ◆ Dew | MCA20 |
| ◆ Dove | MCA12 |
| ◆ Fresh | MCA16 |
| ◆ Mineral | MCA15 |
| ◆ Nectar | MCA19 |
| ◆ Shale | MCA10 |

PRICE CODE B *continued*

| SPIN* | SPIN |
|---------------|--------|
| ◆ Alabaster | SPIN02 |
| ◆ Cavern | SPIN03 |
| ◆ Cobblestone | SPIN04 |
| ◆ Ember | SPIN06 |
| ◆ Flame | SPIN07 |
| ◆ Heron | SPIN13 |
| ◆ Oat | SPIN01 |
| ◆ Ocean | SPIN12 |
| ◆ Plum | SPIN15 |
| ◆ Pool | SPIN11 |
| ◆ Raven | SPIN10 |
| ◆ Rhubarb | SPIN14 |
| ◆ Tropic | SPIN08 |
| ◆ Willow | SPIN05 |

TERRAIN*

| TERRAIN* | TRRN |
|-----------|--------|
| ◆ Bay | TRRN05 |
| ◆ Bayou | TRRN35 |
| ◆ Canyon | TRRN30 |
| ◆ Cliff | TRRN45 |
| ◆ Crest | TRRN25 |
| ◆ Delta | TRRN10 |
| ◆ Plateau | TRRN15 |
| ◆ Ridge | TRRN20 |
| ◆ Valley | TRRN40 |

NOTES: Exchange is applied pattern cut and is not available on 78"W tackboards, Voi® screens, and Empower®.

Disperse is applied pattern cut and is not available on 72"W Accelerate® panels and not available on 66"W tackboards, Voi® screens, and Empower®.

◆◆◆ For lead time information see page 19.

* Directional fabrics

FEATURES OFFERED ON HON LAMINATE CASEGOODS

| | 10500 | 10700 | Valido | Concinnity | 94000 | Voi |
|--|-------|-------|--------|------------|-------|-----|
| Worksurfaces | | | | | | |
| • Scratch, stain and spill-resistant surface over durable 1/4" solid core high performance particleboard | • | • | | • | | • |
| • Scratch, stain and spill-resistant surface over extra-thick 1/2" solid core high performance particleboard | | | • | | | |
| • Scratch, stain and spill-resistant high gloss surface over durable 1/4" solid core high performance particleboard | | | | | • | |
| • Contoured hardwood accent trim | | • | | | • | |
| • User-friendly waterfall-shaped edges and rounded corners improves worker comfort | | • | | | | |
| • Edge profile options | | | | • | | |
| Chassis Construction | | | | | | |
| • European-designed fastening system – Precision, metal-to-metal, fasteners eliminate need for external cleats or exposed screws; enables tops or end panels to be interchanged or replaced | • | • | • | • | • | • |
| • Inner frame constructed using mortise and tenon joinery for superior structural strength and precisely positioning/securing the pedestal to the modesty panel; endures frequent moving/handling; ensures a longer product life cycle | • | • | • | | • | |
| • All fasteners and dowels are positioned by computer to maintain rigorous dimensional standards | • | • | • | • | • | • |
| • End panels on base units and stack-ons feature PVC bottom edgebanding for added strength and to seal out moisture | • | • | • | • | • | • |
| Drawer Construction | | | | | | |
| • Steel ball-bearing drawer suspensions for smooth, quiet, long-lasting operation | • | • | • | • | • | • |
| • 5-sided drawer construction for added strength and easy alignment or replacement of drawer fronts | • | • | • | • | • | • |
| • Full extension box and file drawers | • | • | • | • | • | • |
| • Hangrails provided in all file drawers for side-to-side letter, legal, A4 or EDP filing; and front-to-back for letter filing | • | • | • | • | • | • |
| Amenities | | | | | | |
| • Conference overhang (select models) provides visitor's kneespace on approach side of desk for meetings | • | • | • | • | • | • |
| • Formal, full height modesty panels | • | • | • | • | • | • |
| • Short modesty panel option for easy access to wall electrical outlets | • | • | • | • | | • |
| • Patented, side-mounted drawer handles provide good ergonomics and clean appearance | • | • | | | | |
| • Antique brass drawer handles | | | | | • | |
| • Decorative drawer/door handle design and finish options | | | • | • | | • |
| • Vertical grain direction on drawer fronts and modesty panels | | | | • | • | • |
| • Upscale mixed material door options (select models) on overhead storage | • | • | • | • | • | • |
| • Adjustable hex leveling glides to level furniture without lifting | • | • | • | • | • | • |
| • Pullout reference/writing shelf provides additional worksurface space | | | | | • | |
| • Interchangeable lock cores (allow multiple units to be keyed alike) | • | • | • | • | • | • |
| • Central locking on desks (one lock secures all drawers) | | | | | • | |
| • Cord management (standard) to route and hide wires and cables | • | • | • | • | • | |
| • Cord management options on modular components (worksurfaces, end and modesty panels, pedestals) | | | | • | | • |
| Configuration Options | | | | | | |
| • Components for efficient "U" and "L" shaped workstation layouts | • | • | • | • | • | • |
| • Peninsulas and corner units | • | • | • | • | | |
| • Worksurfaces or shells up to 96"W | • | | | • | | |
| • Standing, 42"H desking solutions | • | | | • | | • |
| • Overheads sized to span multiple base units | • | • | • | • | • | • |
| • Reception station/transaction counter | • | • | • | • | • | |
| • Light scale styling, including worksurface components with O-leg supports | • | | | • | | • |
| • Two-tone color options | • | | • | • | | • |
| Storage Options | | | | | | |
| • 3/4 pedestals provide increased budget flexibility | • | • | • | | | |
| • Full desktop-to-floor pedestals maximize storage space | • | • | • | • | • | • |
| • Modular components/storage with precise, custom cabinet-like fits | | | | • | | • |
| • Modular shells w/ a variety of storage-pedestal solutions | • | • | • | | | |
| • Back wall storage in conventional (65") and executive (78") heights | | | | • | | |
| • Overheads, storage cabinets, wardrobes, lateral files, and bookcases | • | • | • | • | • | • |
| Companion Products | | | | | | |
| • Matching conference tables | • | | | • | • | • |
| • Coordinating conference tables | | • | • | | | |
| Endorsements | | | | | | |
| • Meets or exceeds current ANSI/BIFMA and ISTA standards | • | • | • | • | • | • |
| • Meets SCS Indoor Advantage Certification (see page 17) | • | • | • | • | • | • |
| • level® certified in conformance with the BIFMA e3 furniture sustainability standard | • | • | • | • | • | • |

CONCINNITY™

Want to see more? Scan here
to check out [hon.com](https://www.hon.com).



Concinnity™ Executive Workstation shown with Ignition® and Grove® Seating and Flock® Tables.

CONCINNITY™

Clean styling. Rich woodgrains. Mixed materials. A coordinated suite of components. With Concinnity, you can create an upscale look for all types of office spaces — from open to collaborative to private. Choose from a variety of desk configurations and an extensive selection of storage options to create the ideal solution to fit your footprint and your needs.



FEATURES

- Cohesive visual signature highlighted by clean lines, vertical grain, and components that fit together like custom cabinetry.
- Modular design delivers an unbeatable combination of versatility, style, and personalization to any workspace.
- Wide array of aesthetic options, including edge profiles, handles, mixed materials, and laminate finish combinations.
- Extensive assortment of storage solutions allow users to increase functionality, maximize space and keep everything conveniently within reach.
- Products to create flat, continuous horizontal planes or multi-level, overlapping, layered surfaces.
- Standing-height workstations to support today's healthy work styles; available with adjustable or fixed height bases.

CONCINNITY™ ORDERING INFORMATION

WORKSURFACES

L1 LAMINATES CODES

Woodgrain

- ◆ Bourbon Cherry H
- ◆ Cognac COGN
- ◆ Florence Walnut LFW1
- ◆ Harvest C
- ◆ Kingswood Walnut LK11
- ◆ Mahogany N
- ◆ Mocha MOCH
- ◆ Natural Maple D
- ◆ Pinnacle PINC
- ◆ Shaker Cherry F
- ◆ Sterling Ash LSA1

Solid

- ◆ Black P
- ◆ Charcoal S
- ◆ Designer White LDW1
- ◆ Loft LOFT

Patterned

- ◆ Sheer Mesh * A5
- ◆ Silver Mesh B9

L2 LAMINATES CODES

Woodgrain

- ◆ Lowell Ash LLA1
- ◆ Natural Recon LNRI
- ◆ Phantom Ecru LPE1
- ◆ Portico Teak LPT1
- ◆ Skyline Walnut LSW1

DRAWER AND DOOR FRONTS

L1 LAMINATES CODES

Woodgrain

- ◆ Bourbon Cherry H
- ◆ Cognac COGN
- ◆ Florence Walnut LFW1
- ◆ Harvest C
- ◆ Kingswood Walnut LK11
- ◆ Mahogany N
- ◆ Mocha MOCH
- ◆ Natural Maple D
- ◆ Pinnacle PINC
- ◆ Shaker Cherry F
- ◆ Sterling Ash LSA1

Solid

- ◆ Black P
- ◆ Charcoal S
- ◆ Designer White LDW1
- ◆ Loft LOFT

L2 LAMINATES CODES

Woodgrain

- ◆ Lowell Ash LLA1
- ◆ Natural Recon LNRI
- ◆ Phantom Ecru LPE1
- ◆ Portico Teak LPT1
- ◆ Skyline Walnut LSW1

HANDLE/LOCK

FINISHES CODES

P1

- ◆ Black P
- ◆ Satin SA

CHASSIS, END, MODESTY, AND BACK PANELS

L1 LAMINATES CODES

Woodgrain

- ◆ Bourbon Cherry H
- ◆ Cognac COGN
- ◆ Florence Walnut LFW1
- ◆ Harvest C
- ◆ Kingswood Walnut LK11
- ◆ Mahogany N
- ◆ Mocha MOCH
- ◆ Natural Maple D
- ◆ Pinnacle PINC
- ◆ Shaker Cherry F
- ◆ Sterling Ash LSA1

Solid

- ◆ Black P
- ◆ Charcoal S
- ◆ Designer White LDW1
- ◆ Loft LOFT

L2 LAMINATES CODES

Woodgrain

- ◆ Lowell Ash LLA1
- ◆ Natural Recon LNRI
- ◆ Phantom Ecru LPE1
- ◆ Portico Teak LPT1
- ◆ Skyline Walnut LSW1

HMBPOST AND HMBTLEG24

PAINTS CODES

P1

- ◆ Black P

P2

- ◆ Platinum Metallic T1

SILVER COLORWAY: The following finish options are coordinating silver colorways — Satin, Satin Nickel, Matte Chrome, Platinum, and Platinum Metallic.

EDGE PROFILES “B” AND “V”

EDGEBAND COLORS CODES

Woodgrain

- ◆ Bourbon Cherry H
- ◆ Cognac COGN
- ◆ Florence Walnut FW
- ◆ Harvest C
- ◆ Kingswood Walnut KI
- ◆ Mahogany N
- ◆ Mocha MOCH
- ◆ Natural Maple D
- ◆ Pinnacle PINC
- ◆ Shaker Cherry F
- ◆ Sterling Ash SA

EDGE PROFILE “G”

EDGEBAND COLORS CODES

Woodgrain

- ◆ Bourbon Cherry H
- ◆ Cognac COGN
- ◆ Florence Walnut FW
- ◆ Harvest C
- ◆ Kingswood Walnut KI
- ◆ Lowell Ash DL
- ◆ Mahogany N
- ◆ Mocha MOCH
- ◆ Natural Maple D
- ◆ Natural Recon NR
- ◆ Phantom Ecru PE
- ◆ Pinnacle PINC
- ◆ Portico Teak DP
- ◆ Shaker Cherry F
- ◆ Skyline Walnut SW
- ◆ Sterling Ash SA

Solid

- ◆ Black P
- ◆ Brownstone EY
- ◆ Charcoal S
- ◆ Designer White DW
- ◆ Fossil EH
- ◆ Loft LOFT

Pattern laminates do not have a matching edgiband color; they are available with a woodgrain or solid color edge.

◆◆◆ For lead time information see page 19.

* De-emphasized

CONCINNITY™ LAMINATE DESIGN/MATERIALS INFORMATION

STYLING AND CONSTRUCTION

- Conventional desking or light scale components.
- Clean, uninterrupted lines and precise fits; no gaps.
- All end, modesty, and back panels, as well as drawer and door fronts, that are specified in a woodgrain color, feature vertical grain; drawer fronts are vertically-aligned, continuous grain and are matched sets.
 - Modesty panels wider than 60" have horizontal grain on L2 and non-standard finishes.
- All desk, credenza, and return models feature full-to-the-floor pedestals to maximize storage space.
- Factory-configured (i.e., built-up; assembled) 72"W desks can be specified with breakfront or recessed modesty panels.
- Formal, full height modesty panels on factory-configured (i.e., built-up; assembled) desks, credenzas, and returns; modular components available with full or 10" modesty panels.
- Drawer and door fronts over end panels.
- Back panel-over-end panel on desks, credenzas, returns, mobile pedestals, 29½"H lateral files and storage cabinets, and full-length modesty panels for modular pedestals.
- Top-between-end panels on stack-on and wall mount storage, 66⅝"H & 79½"H storage and combination storage cabinets, wardrobes and towers.
- Option choices include:
 - Edge profile and edge color
 - Handle design
 - Handle/worksurface grommet/lock face finish
 - Worksurface color
 - Chassis color
 - Drawer front/door color
- **IMPORTANT NOTE:** Designed and sized to coordinate with 65"H Accelerate® Panels.
 - Desks, credenzas, returns, 2-drawer lateral files, and 29½"H storage cabinets, plus 35¼"H stack-on storage or bookcase hutch, are 64¾"H.
 - Additional solutions ≤65"H include the following: storage cabinet, storage/file cabinet, storage cabinet/lateral file, 18" and 36"W wardrobe/storage cabinets, wardrobe/bookcase, storage tower, and 5-shelf bookcase.

MATERIALS

- Easy-care, scratch-, spill- and stain-resistant thermal-fused laminate (TFL) over solid core, high performance particleboard;
 - Component model thickness: 1⅛" worksurfaces and end panels; ¾" modesty panel and drawer/door fronts.

- Durable, impact-resistant banding protects edges.
- Bottom of end panels on base units and stack-ons feature edgebanding for added strength and to seal out moisture.
- HPL worksurfaces are available via special request.

DRAWER SPECIFICATIONS

- Operate on steel ball-bearing slides to ensure smooth, quiet, long-lasting operation.
- Full extension drawers allow complete access to contents.
- Drawers feature 5-sided construction for added strength and easy alignment or replacement of drawer fronts.
- File drawers include integrated hangrails for side-to-side letter or legal filing; and front-to-back for letter filing.
- One molded black pencil tray is included in each box/box/file pedestal.
- Drawer fronts are edgebanded on all four sides.

CORE REMOVABLE LOCKS

- All drawers/doors lock on the following products:
 - All desk, credenza, and return pedestals (NOTE: The lock is on the face of the pedestal)
 - Stack-on and wall mount storage with laminate locking doors ("LL" models)
 - Wall mount storage with sliding door
 - Mobile pedestals
 - Lateral files
 - Storage cabinets
 - Storage/file cabinet
 - Storage cabinet/lateral file
 - Wardrobe/storage cabinets
 - Storage towers
 - Modular pedestals
- On products that are equipped with two locks, the locks are keyed alike:
 - Double pedestal desks
 - Credenza with storage
 - Credenzas with kneespace
 - Low credenzas with four drawers
 - Storage and combination storage/file cabinets
 - Storage towers
 - Stack-on and wall mount storage 60" - 78"W
- Lock faces are available in black or satin.

CONCINNITY™ LAMINATE DESIGN/MATERIALS INFORMATION

- Locks feature a removable cylinder (core) that can be interchanged as needed; allows all furniture pieces within an individual workstation to be accessed with one key for convenience, and allows locks to be differentiated between workstations and offices for security. Makes re-keying quick and easy.
 - Keyed alike cores must be ordered separately by specification of the key number. For all products, except stack-on and wall mounted storage, the removable lock core kits are HF23B for Black and HF23S for Satin (Silver).
 - EXCEPTION - IMPORTANT - NOTE: The removable lock core kit for stack-on and wall mounted storage is model HF27B (Black) or HF27S (Satin).

CORD MANAGEMENT

- Cord management grommets and pass-through cutouts, for routing and hiding wires and cables, are standard in a pre-determined location on a number of factory-configured (i.e., built-up; assembled) products:
 - Two grommets are located in the tops of desks and credenzas; one grommet is located in the top of returns, bridges, jetty peninsulas, and corner units.
 - All desk, credenza, and return pedestals are designed with two cord pass-through grommets, one per side; end panels of single pedestal desks and single pedestal credenzas feature one cord pass-through grommet.
 - Pass-through in the sides of pedestals and end panels enable the routing of cords below the worksurface and connections between workstations.
 - A pass-through grommet, to facilitate reaching wall electrical outlets, is located in the back panels of credenza with storage, credenza with kneespace, single pedestal credenzas, credenzas with 36" lateral file, returns and bridges.
- See chart on page 34 for cord management options. Worksurfaces/tops, end and modesty panels, and pedestals can be specified with or without grommets.
- Grommets on worksurfaces are sized to accept optional grommet mount power hub (HGRMTAC) and USB (HGRMTUSB2) models.

- Grommet color/shape/size:
 - Worksurfaces, Black or Platinum, Round, 3" diameter hole with a 3½" plastic cap.
 - Back/modesty panels, Black, Round, 2½" diameter hole with a 3" plastic cap.
 - End panels and pedestal sides, Black, Half-round, 1¾" diameter hole with a 2" x 2½" plastic cap.

LEVELING GLIDES

- Adjustable hex glides to compensate for uneven floors; allow furniture to be easily leveled without lifting the unit.
 - Glides have a 1¼" adjustable range.
 - The hex adjustment is on the foot of the glide for all products except for the 9½", 15¾", and 18"W modular pedestals, in which case it is on the top of the glide stem.

IMPORTANT — OTHER







- Products ship fully assembled, unless otherwise noted (NOTE:  — easy-to-assemble — items are designated in the "DESCRIPTIONS").
- All models must meet or exceed ANSI/BIFMA & ISTA performance standards.
- Products covered by HON Limited Lifetime Warranty.
- Indoor Advantage™ Gold. Indoor Air Quality Certified to SCS-EC10.3-2014 v3.0.
- BIFMA level® 2 certified. Conforms to ANSI/BIFMA e32014e Furniture Sustainability Standard.

CONCINNITY™

LAMINATE ORDERING/SPECIFICATION INFORMATION

WORKSURFACE/TOP EDGE DETAILS

- Three options; two contoured profiles and one smooth, flat edge.
- For beaded (B) and tri-oval (V) edge shapes, tops are profiled on the user and approach sides, and flat on the ends; the flat edges allow side-by-side placement of worksurfaces without gaps. The only exceptions are return, bridge, corner unit, extended corner worksurface, and rectangle worksurface with vertical grain models, tops on these items are profiled on the user's side and flat banded on the approach side and ends.
 - Bookcases have profiled edge on the front, user side only.
 - The reception station transaction counter and the L-reception station with transaction counter (for the desk) models, have profiled edgeband on the approach and user sides.
 - The L-reception station with the transaction counter models, on which the counter runs around the entire perimeter of the L-configuration, have a profiled edge on the front of the transaction counter on the desk approach side only.

| Edge Options: | Profiles | Designator |
|---------------|---|---|
| Beaded |  |  B |
| Smooth, Flat |  |  G |
| Tri-Oval |  |  V |

WORKSURFACE EDGE COLORS

- Woodgrain and solid color laminates can be specified with a matching, complementary, or contrasting edgeband color; options include:
 - Matching the worksurface edge to a common worksurface, chassis, and drawer front color.
 - Matching the worksurface edge to the worksurface laminate and selecting a different laminate color for the chassis.
 - Matching the worksurface edge to the chassis laminate and selecting a different laminate color for the worksurface.

- Beaded (B) and tri-oval (V) edges are available in L1 woodgrain colors only.
- The smooth, flat (G) edge is available in woodgrain and solid colors.
- Pattern laminates do not have a matching edgeband color; the patterns are available with a woodgrain or solid color edge.

DRAWER/DOOR DECORATIVE HANDLES

- Three handle style options, each available in Satin or Black finish.
- Distinct, easy to grasp designs.
- Handles are metal.
- The hole spacing is 128mm.
- The handle style/finish has to be specified on drawer fronts (desk/credenza/return, mobile and modular pedestals), lateral file drawer fronts, the doors of the storage cabinet, storage/file cabinet, storage cabinet/lateral file, wardrobe/storage cabinet, wardrobe/bookcase, and storage tower.
 - NOTE: Decorative handles are not used on the doors of stack-on storage units or wall mounted storage cabinets.
 - Bookcase hutches with frosted doors are equipped with a push latch release.

| Handle Options | Finish | Designator |
|----------------|--------|------------|
| Cylinder | Satin | A |
| Cylinder | Black | B |
| Canopy | Satin | C |
| Canopy | Black | D |
| Loop | Satin | E |
| Loop | Black | F |

- NOTE: The Linear and Arch field installable drawer/door handle kit models can be attached using 128mm hole spacing.

CONCINNITY™

LAMINATE ORDERING/SPECIFICATION INFORMATION

CORD MANAGEMENT GROMMETS

- Grommets are standard on desk, credenza, return, bridge, jetty peninsula, and corner unit models. Specification logic includes the grommet finish for tops; choose from Black (P) or Platinum (T1). Grommets in modesty and end panels are Black only.
- Grommets are optional on modular component worksurfaces, full-length (27⁷/₈"H) modesty panels, end panels (1¹/₈", L-shaped) and the sides of support storage pedestals. On worksurfaces, choose from Black (P), Platinum (T1), or no grommet(s) (X). On modesty, end, and side panels the options are grommet Black (P) or no grommet (X).
- See cord management chart on page 34 for details.

LOCK FINISH

- Finish is determined by, and automatically aligned with, the handle finish specified. If there is no decorative handle on the product, such as on locking stack-on or wall mount storage models, the lock finish is specified separately in the option string.
 - When specification is required, the lock finish options are Black (P) or Satin (SA).
- Removable, interchangeable lock core kits must be ordered separately:
 - For all models, except stack-on and wall mount storage, specify model HF23B (Black) or HF23S (Satin), and the specific key number required.
 - For stack-on and wall mount storage, specify model HF27B (Black) or HF27S (Satin), and the specific key number required.

SILVER COLORWAY

- The following finish options are coordinating Silver colorways: Satin, Satin Nickel, Matte Chrome, Platinum, and Platinum Metallic.

LAMINATE COLORS

- Palette choices include sixteen (16) woodgrain, four (4) solid, and two (2) pattern colors.

| Woodgrain | | Solid Color | | Pattern | |
|------------------|------|----------------|------|-------------|----|
| Bourbon Cherry | H | Black | P | Sheer Mesh | A5 |
| Cognac | COGN | Charcoal | S | Silver Mesh | B9 |
| Florence Walnut | LFW1 | Designer White | LDW1 | | |
| Harvest | C | Loft | LOFT | | |
| Kingswood Walnut | LKI1 | | | | |
| Lowell Ash | LLA1 | | | | |
| Mahogany | N | | | | |
| Mocha | MOCH | | | | |
| Natural Maple | D | | | | |
| Natural Recon | LNR1 | | | | |
| Phantom Ecru | LPE1 | | | | |
| Pinnacle | PINC | | | | |
| Portico Teak | LPT1 | | | | |
| Shaker Cherry | F | | | | |
| Skyline Walnut | LSW1 | | | | |
| Sterling Ash | LSA1 | | | | |

- Worksurface, chassis and drawer/door fronts are specified separately to enable a single, color-matched visual, or a complementary or contrasting, multi-tone aesthetic.
- Worksurfaces/tops are available in woodgrain, solid, or pattern laminate colors.
- Chassis and drawer fronts are available in woodgrain or solid laminate colors.
- Pattern colors are available on worksurface tops only.

| Worksurface | | Chassis | | Drawer/Door | |
|------------------|------|------------------|------|------------------|------|
| Bourbon Cherry | H | Bourbon Cherry | H | Bourbon Cherry | H |
| Cognac | COGN | Cognac | COGN | Cognac | COGN |
| Florence Walnut | LFW1 | Florence Walnut | LFW1 | Florence Walnut | LFW1 |
| Harvest | C | Harvest | C | Harvest | C |
| Kingswood Walnut | LKI1 | Kingswood Walnut | LKI1 | Kingswood Walnut | LKI1 |
| Lowell Ash | LLA1 | Lowell Ash | LLA1 | Lowell Ash | LLA1 |
| Mahogany | N | Mahogany | N | Mahogany | N |
| Mocha | MOCH | Mocha | MOCH | Mocha | MOCH |
| Natural Maple | D | Natural Maple | D | Natural Maple | D |
| Natural Recon | LNR1 | Natural Recon | LNR1 | Natural Recon | LNR1 |
| Phantom Ecru | LPE1 | Phantom Ecru | LPE1 | Phantom Ecru | LPE1 |
| Pinnacle | PINC | Pinnacle | PINC | Pinnacle | PINC |
| Portico Teak | LPT1 | Portico Teak | LPT1 | Portico Teak | LPT1 |
| Shaker Cherry | F | Shaker Cherry | F | Shaker Cherry | F |
| Skyline Walnut | LSW1 | Skyline Walnut | LSW1 | Skyline Walnut | LSW1 |
| Sterling Ash | LSA1 | Sterling Ash | LSA1 | Sterling Ash | LSA1 |
| Black | P | Black | P | Black | P |
| Charcoal | S | Charcoal | S | Charcoal | S |
| Designer White | LDW1 | Designer White | LDW1 | Designer White | LDW1 |
| Loft | LOFT | Loft | LOFT | Loft | LOFT |
| Sheer Mesh | A5 | | | | |
| Silver Mesh | B9 | | | | |

- Two-tone color options allow specification of different, complementary laminate combinations:

| Color #1 | Color #2 |
|-----------------------|---------------------------|
| Top | Chassis and Drawer Fronts |
| Top and Drawer Fronts | Chassis |
| Top and Chassis | Drawer Fronts |

- Modesty panels and the backs of storage chassis that are specified in L2 laminates and wider than 60"W will ship as horizontal grain.

CONCINNITY™ CORD MANAGEMENT

| | GROMMET | # OF GROMMETS | LOCATION | CUTOUT SHAPE | MATERIAL | COLOR/FINISH |
|---|--|---------------|--|--------------|----------|-------------------|
| BUILT-UP/FACTORY-CONFIGURED | | | | | | |
| DESK | | | | | | |
| Top | Standard/Fixed Location | 2 | Back Left & Right | 3" Round | Plastic | Black or Platinum |
| End Panel | Standard/Fixed Location | 2 (1 per EP) | Top Back Corner | 1¼" Round | Plastic | Black |
| Modesty/Back | Not Available | 0 | N/A | N/A | N/A | N/A |
| CREDENZA | | | | | | |
| Top | Standard/Fixed Location | 2 | Back Left & Right | 3" Round | Plastic | Black or Platinum |
| End Panel | Standard/Fixed Location | 2 (1 per EP) | Top Back Corner | 1¼" Round | Plastic | Black |
| Modesty/Back | Standard/Fixed Location | 1 | Top Center | 2½" Round | Plastic | Black |
| RETURN | | | | | | |
| Top | Standard/Fixed Location | 1 | Top Center | 3" Round | Plastic | Black or Platinum |
| End Panel | Standard/Fixed Location | 1 | Top Back Corner | 1¼" Round | Plastic | Black |
| Modesty/Back | Standard/Fixed Location | 1 | Top Center | 2½" Round | Plastic | Black |
| BRIDGE | | | | | | |
| Top | Standard/Fixed Location | 1 | Back Center | 3" Round | Plastic | Black or Platinum |
| Modesty/Back | Standard/Fixed Location | 1 | Top Center | 2½" Round | Plastic | Black |
| BULLET PENINSULA | | | | | | |
| Top | Not Available | 0 | | | | |
| End Panel | Not Available; Pass-Thru in Brace Panel | 0 | | | | |
| JETTY PENINSULA | | | | | | |
| Top | Standard/Fixed Location | 1 | Back, Approach-Side Corner | 3" Round | Plastic | Black or Platinum |
| End Panel | Not Available; Pass-Thru Standard in Brace Panel | 0 | | | | |
| CORNER UNIT | | | | | | |
| Top | Standard/Fixed Location | 1 | Back Corner | 3" Round | Plastic | Black or Platinum |
| Modesty/Back | Not Available; Pass-Thru Standard in Brace Panels | 0 | | | | |
| Stack-on | Standard/Fixed Location | 1 | 1¼" Side-to-Side Gap at Top or Bottom of Back Panel, Below Cabinet | | | |
| MODULAR COMPONENTS – WORKSURFACES | | | | | | |
| Rectangle – 60" to 96"W | Optional – Specify: Black (P) or Platinum (T1) or None (X) | 2 | Back Left & Right | 3" Round | Plastic | Black or Platinum |
| Rectangle – 30" to 54"W | Optional – Specify: Black (P) or Platinum (T1) or None (X) | 1 | Back Center | 3" Round | Plastic | Black or Platinum |
| Bullet Shape | Optional – Specify: Black (P) or Platinum (T1) or None (X) | 1 | Centered Along EP; Over Brace Leg Cutout | 3" Round | Plastic | Black or Platinum |
| Ext. Corner | Optional – Specify: Black (P) or Platinum (T1) or None (X) | 1 | Back Corner of Top and Long End Panel | 3" Round | Plastic | Black or Platinum |
| MODULAR COMPONENTS – MODESTY PANELS | | | | | | |
| Full-Length – ≥30"W | Optional – Specify: Black (P) or None (X) | 1 | Top Center | 2½" Round | Plastic | Black |
| 10" | No | 0 | | | | |
| MODULAR COMPONENTS – END PANELS | | | | | | |
| 1½" Thick | Optional – Specify: Black (P) or None (X) | 1 | Top Back Corner | 1¼" Round | Plastic | Black |
| T-Shaped | No | 0 | | | | |
| L-Shaped | Optional – Specify: Black (P) or None (X) | 1 | Top or Bottom Centered | 1¼" Round | Plastic | Black |
| MODULAR COMPONENTS – STORAGE PEDESTALS | | | | | | |
| Pedestal | Optional – Specify: Black (P) or None (X) | 2 (1 per EP) | Top Back Corner | 1¼" Round | Plastic | Black |

NOTE: If customer wants a desk, credenza, return, or bridge without grommets, they can specify modular components.

Grommet Locations in Tops

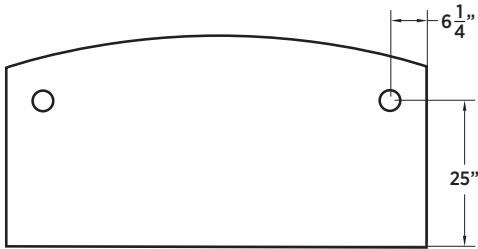

Bow Top Desks and Worksurfaces

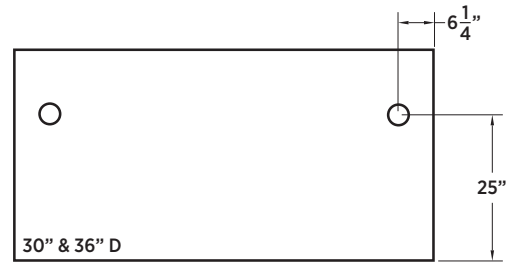

Desks and Rectangle Worksurfaces

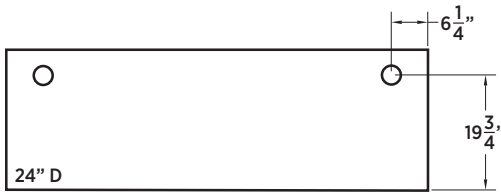

Credenzas and Rectangle Worksurfaces

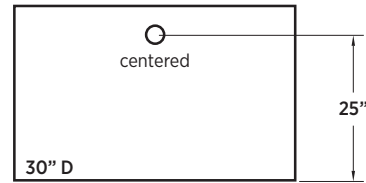

Rectangle Worksurfaces

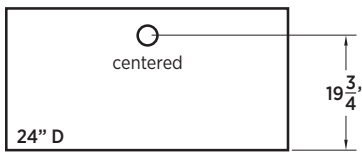

Returns, Bridges, and Rectangle Worksurfaces

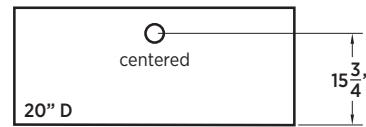

Rectangle Worksurfaces

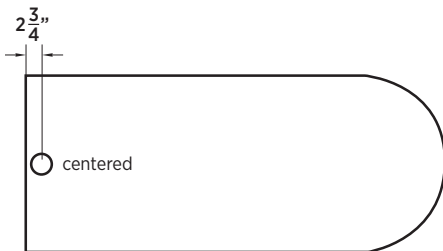

Bullet Worksurfaces

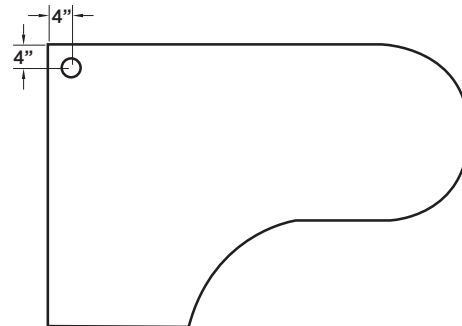

Jetty Peninsula

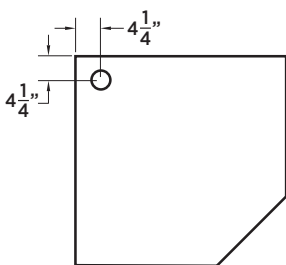

Corner Unit

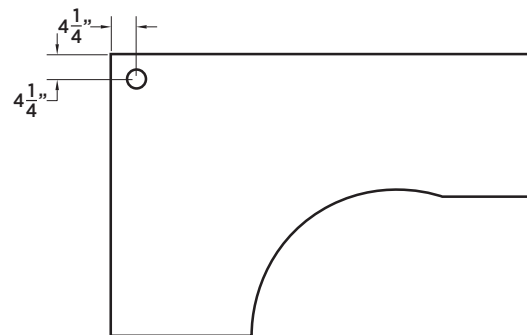

Extended Corner Worksurfaces

CONCINNITY™

Typicals



Icon Legend on page 19

| QTY | DESCRIPTION | MODEL | LIST PRICE | PRICE EXTENSION |
|---------------|---|---------------|-----------------|-----------------|
| 1 | Double Pedestal Desk, Bow Top, Breakfront Frosted Modesty Panel 72"W x 36"D x 29½"H | HNL3672DPBBF | \$3,153 | \$3,153 |
| 1 | Credenza with Kneespace 72"W x 24"D x 29½"H | HNL2472DPK | \$1,989 | \$1,989 |
| 1 | Wall Mount Storage, Frosted Doors with Silver Frame 72"W x 15"D x 28½"H | HNL2972FD | \$2,607 | \$2,607 |
| 1 | Storage/File Cabinet, Hinged Right 18"W x 24"D x 64¾"H | HNL241865SFLR | \$1,903 | \$1,903 |
| 1 | Storage/File Cabinet, Hinged Left 18"W x 24"D x 64¾"H | HNL241865SFL | \$1,903 | \$1,903 |
| TOTAL: | | | \$11,555 | |

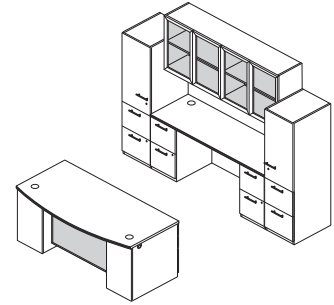
**DESK — CREDENZA — STORAGE**

| QTY | DESCRIPTION | MODEL | LIST PRICE | PRICE EXTENSION |
|---------------|---|--------------|----------------|-----------------|
| 1 | Left Pedestal Desk, Rectangle Top, Breakfront Modesty Panel 72"W x 36"D x 29½"H | HNL3672LPRB | \$2,090 | \$2,090 |
| 1 | Rectangle Worksurface with Vertical Grain 42"W x 24"D | HNLRC2442V | \$281 | \$281 |
| 1 | Narrow File/File Pedestal 9½"W x 23⅞"D x 28½"H | HNL231028PFF | \$756 | \$756 |
| 1 | Modesty/Back Panel — Full-Length 42"W x 27⅞"H | HNLMP4228 | \$224 | \$224 |
| 1 | Stack-on Storage, Sliding Door 78"W x 15"D x 35¼"H | HNL3678SD | \$1,387 | \$1,387 |
| 1 | Storage/File Cabinet, Open Shelves 18"W x 24"D x 64¾"H | HNL241865SFX | \$1,807 | \$1,807 |
| TOTAL: | | | \$6,545 | |

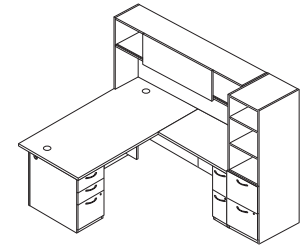
**L-WORKSTATION**

| QTY | DESCRIPTION | MODEL | LIST PRICE | PRICE EXTENSION |
|---------------|---|---------------|----------------|-----------------|
| 1 | Rectangle Worksurface 72"W x 30"D | HNLRC3072 | \$470 | \$470 |
| 1 | Narrow Box/Box/File Pedestal 9½"W x 29⅞"D x 28½"H | HNL291028PBBF | \$844 | \$844 |
| 1 | Full Back Panel — For 9½"W Pedestal 9½"W x 27⅞"H | HNLPB1028 | \$139 | \$139 |
| 1 | Laminate Floating Modesty Panel 36"W x 14"H | HLSL3614L | \$202 | \$202 |
| 1 | Bookcase End Support 12"W x 30"D x 28½"H | HNL123028BKE | \$556 | \$556 |
| 1 | Rectangle Worksurface 72"W x 24"D | HNLRC2472 | \$402 | \$402 |
| 1 | Shelf/Box/Box/Lateral File Pedestal 36"W x 23⅞"D x 28½"H | HNL233628PSL | \$1,362 | \$1,362 |
| 1 | Storage Cabinet Pedestal 36"W x 23⅞"D x 28½"H | HNL233628PSC | \$887 | \$887 |
| 1 | Modesty/Back Panel — Full-Length 72"W x 27⅞"H | HNLMP7228 | \$314 | \$314 |
| 1 | Stack-on Storage, Sliding Door 72"W x 15"D x 35¼"H | HNL3672SD | \$1,345 | \$1,345 |
| 1 | Bookcase with Coat Hooks, 5-Shelf, Left 24"W x 24"D x 64¾"H | HNL2424BK5CL | \$1,048 | \$1,048 |
| TOTAL: | | | \$7,569 | |

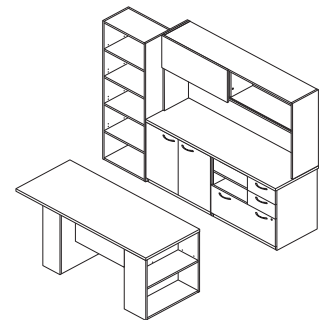
**DESK — CREDENZA — STORAGE**



Icon Legend on page 19

CONCINNITY™ Typicals

DESKS

| QTY | DESCRIPTION | MODEL | LIST PRICE | PRICE EXTENSION |
|-----|---|--------------|------------|-----------------|
| 1 | Rectangle Worksurface 60"W x 24"D | HNLRC2460 | \$358 | \$358 |
| 1 | Height Adjustable Base | HHATB3S2LT | \$1,047 | \$1,047 |
| 1 | External Stiffener 48"W for 54" Worksurface | HLSLZ5SC60 | \$106 | \$106 |
| 1 | Rectangle Worksurface 84"W x 24"D | HNLRC2484 | \$540 | \$540 |
| 1 | End Panel, Left 1½"W x 23⅝"D x 28½"H | HNLEP2428L | \$224 | \$224 |
| 1 | Shelf/Box/Box/Lateral File Pedestal 36"W x 23⅝"D x 28½"H | HNL233628PSL | \$1,362 | \$1,362 |
| 1 | Modesty/Back Panel — Short 84"W x 10"H | HNLMP8410 | \$381 | \$381 |
| 1 | Low Back Panel — For 28½"H Pedestal 36"W x 18"H | HNLB3618 | \$164 | \$164 |
| 2 | Stack-on Storage, Frosted Doors with Silver Frame 42"W x 15"D x 35¼"H | HNL3642FD | \$1,451 | \$2,902 |
| 1 | Space Saver End Panels for Stack-on Storage ¾"W x 14¼"D x 35¼"H | HNL3605SSEP | \$417 | \$417 |
| 1 | Wardrobe/Storage Cabinet, Hinged Right 18"W x 24"D x 64¾"H | HNL241865WLR | \$1,739 | \$1,739 |

TOTAL: \$9,240

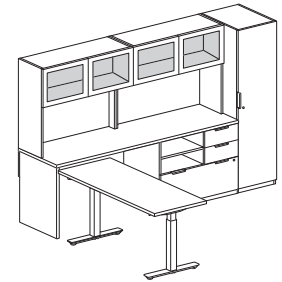

L-WORKSTATION WITH HEIGHT-ADJUSTABLE DESK — OPEN PLAN

| QTY | DESCRIPTION | MODEL | LIST PRICE | PRICE EXTENSION |
|-----|---|--------------|------------|-----------------|
| 1 | Bullet Worksurface 84"W x 30"D | HNLBU3084 | \$660 | \$660 |
| 1 | T-Shaped End Panel — For Bullet Worksurface 11⅝"W x 29⅞"D x 28½"H | HNLTEP3028 | \$386 | \$386 |
| 1 | Support Column — For Bullet Worksurface 3" Diameter | HPC190X | \$173 | \$173 |
| 1 | Bridge 48"W x 24"D x 29½"H | HNL2448BF | \$491 | \$491 |
| 1 | Rectangle Worksurface 84"W x 24"D | HNLRC2484 | \$540 | \$540 |
| 1 | End Panel, Left 1½"W x 23⅝"D x 28½"H | HNLEP2428L | \$224 | \$224 |
| 1 | Shelf/Box/Box/Lateral File Pedestal 36"W x 23⅝"D x 28½"H | HNL233628PSL | \$1,362 | \$1,362 |
| 1 | Modesty/Back Panel — Full-Length 84"W x 27⅞"H | HNLMP8428 | \$381 | \$381 |
| 2 | Stack-on Storage, Laminate Doors 42"W x 15"D x 48⅝"H | HNL4942LD | \$1,320 | \$2,640 |
| 1 | Space Saver End Panels for Stack-on Storage ¾"W x 14¼"D x 48⅝"H | HNL4905SSEP | \$561 | \$561 |

TOTAL: \$7,418

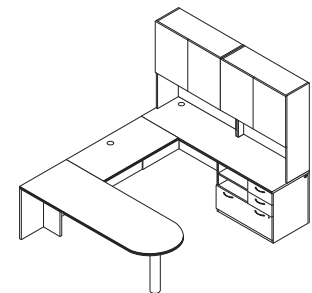

U-WORKSTATION WITH 84" W WORKSURFACE

| QTY | DESCRIPTION | MODEL | LIST PRICE | PRICE EXTENSION |
|-----|---|---------------|------------|-----------------|
| 1 | Left Pedestal Desk, Rectangle Top, Breakfront Frosted Modesty Panel 72"W x 36"D x 29½"H | HNL3672LPRBF | \$2,608 | \$2,608 |
| 1 | Rectangle Worksurface with Vertical Grain 48"W x 24"D | HNLRC2448V | \$302 | \$302 |
| 1 | Modesty/Back Panel — Short 48"W x 10"H | HNLMP4810 | \$244 | \$244 |
| 1 | Right Credenza with Lateral File 72"W x 24"D x 29½"H | HNL2472RLC | \$1,733 | \$1,733 |
| 1 | Stack-on Storage, Frosted Doors with Silver Frame 72"W x 15"D x 48⅝"H | HNL4972FD | \$2,839 | \$2,839 |
| 1 | Vertical Paper Manager | HLVPM1 | \$351 | \$351 |
| 1 | Wardrobe Left, Bookcase Right 36"W x 24"D x 78⅞"H | HNL243679WLBR | \$2,771 | \$2,771 |

TOTAL: \$10,848

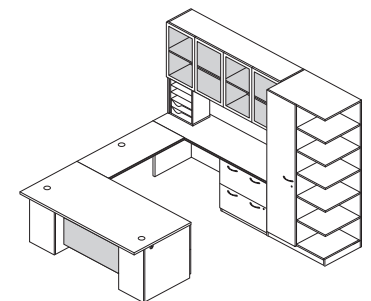

U-WORKSTATION

CONCINNITY™

Typicals



Icon Legend on page 19

| QTY | DESCRIPTION | MODEL | LIST PRICE | PRICE EXTENSION |
|-----|--|---------------|---------------|-----------------|
| 1 | Rectangle Worksurface 72"W x 30"D | HNLRC3072 | \$470 | \$470 |
| 1 | Rectangle Worksurface with Vertical Grain 42"W x 24"D | HNLRC2442V | \$281 | \$281 |
| 1 | Height Adjustable Base, 3-Leg | HHATB3S3LT | \$1,729 | \$1,729 |
| 1 | External Stiffener 60"W for 66" Worksurface | HLSLZ5SC72 | \$119 | \$119 |
| 1 | Mixed Material Floating Modesty Panel 60"W x 14"H | HLSL6014MM | \$1,243 | \$1,243 |
| 1 | Rectangle Worksurface 72"W x 24"D | HNLRC2472 | \$402 | \$402 |
| 1 | End Panel, Right 1½"W x 23½"D x 28½"H | HNLEP2428R | \$224 | \$224 |
| 1 | Box/Box/File Pedestal 15¾"W x 23½"D x 28½"H | HNL231628PBBF | \$782 | \$782 |
| 1 | Low Back Panel — For 15¾"W Pedestal 15¾"W x 18"H | HNLLB1618 | \$141 | \$141 |
| 1 | Modesty/Back Panel — Short 72"W x 10"H | HNLMP7210 | \$314 | \$314 |
| 1 | Wall Mount Storage, Frosted Doors with Silver Frame 72"W x 15"D x 15"H | HNL1572FD | \$1,961 | \$1,961 |
| 1 | Storage/File Cabinet, Hinged Left 18"W x 24"D x 64¾"H | HNL241865SFL | \$1,903 | \$1,903 |
| | | | TOTAL: | \$9,569 |

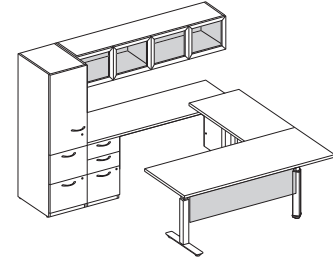

U-WORKSTATION WITH HEIGHT-ADJUSTABLE L-WORKSURFACE

| QTY | DESCRIPTION | MODEL | LIST PRICE | PRICE EXTENSION |
|-----|--|----------------|---------------|-----------------|
| 1 | Rectangle Worksurface 72"W x 24"D | HNLRC2472 | \$402 | \$402 |
| 2 | O-Leg Support for 24"D Worksurface 24"D x 28½"H | HLSL2428O | \$357 | \$714 |
| 1 | External Support Channel for 72"W Worksurface | HLSLZ5SC78 | \$119 | \$119 |
| 1 | Low Credenza, Drawers Left, Bookcase Right 60"W x 20"D x 21½"H | HNL206021LD2 | \$1,384 | \$1,384 |
| 1 | Rectangle Worksurface 54"W x 24"D | HNLRC2454 | \$328 | \$328 |
| 1 | Standing-Height O-Leg Support for 24"D Worksurface 24"D x 41"H | HLSL2441O | \$476 | \$476 |
| 1 | Narrow Box/Box/File/File Pedestal 9½"W x 23½"D x 41"H | HNL231041PBBFF | \$1,446 | \$1,446 |
| 1 | Full Back Panel — For 41"H Pedestal 9½"W x 40¾"H | HNLPB1041 | \$153 | \$153 |
| 1 | Storage Tower, Hinged Left 18"W x 24"D x 50"H | HNL241850TLL | \$1,362 | \$1,362 |
| | | | TOTAL: | \$6,384 |

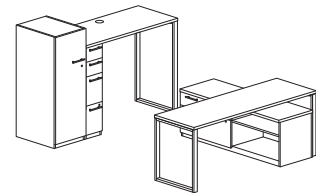

U-WORKSTATION WITH SITTING AND STANDING-HEIGHT WORKSURFACES — OPEN PLAN



Icon Legend on page 19

CONCINNITY™ Typicals

| QTY | DESCRIPTION | MODEL | LIST PRICE | PRICE EXTENSION |
|---------------|---|--------------|----------------|-----------------|
| 1 | Rectangle Worksurface 72"W x 30"D | HNLRC3072 | \$470 | \$470 |
| 1 | O-Leg Support for 30"D Worksurface 30"D x 28½"H | HLSL30280 | \$395 | \$395 |
| 1 | O-Leg Support over Low Credenza 30"D x 7"H | HLSL3070 | \$305 | \$305 |
| 1 | External Support Channel for 72"W Worksurface | HLSLZ5SC78 | \$119 | \$119 |
| 1 | Low Credenza, Drawers Right, Bookcase Left 60"W x 20"D x 21½"H | HNL206021RD2 | \$1,384 | \$1,384 |
| 1 | Low Credenza, Drawers Left, Bookcase Right 60"W x 20"D x 21½"H | HNL206021LD2 | \$1,384 | \$1,384 |
| 2 | Wall Mount Storage, Laminate Doors 30"W x 15"D x 28½"H | HNL2930LD | \$897 | \$1,794 |
| 1 | Wall Mount Storage, Frosted Doors with Silver Frame 30"W x 15"D x 28½"H | HNL2930FD | \$1,418 | \$1,418 |
| 1 | Wall Mount Markerboard 30"W x 48⅝"H | HNL4930WB | \$249 | \$249 |
| TOTAL: | | | \$7,518 | |

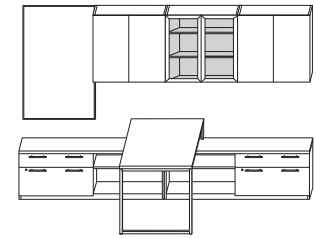

**WORKSTATION WITH
WORKWALL – OPEN PLAN**

| QTY | DESCRIPTION | MODEL | LIST PRICE | PRICE EXTENSION |
|---------------|--|--------------|-----------------|-----------------|
| 3 | Rectangle Worksurface with Vertical Grain 48"W x 24"D | HNLRC2448V | \$302 | \$906 |
| 3 | O-Leg Support for 48"W x 24"D Worksurface 24"D x 28½"H | HLSL24280 | \$357 | \$1,071 |
| 3 | Mixed Material Floating Modesty Panel 42"W x 14"H | HLSL4214MM | \$906 | \$2,718 |
| 3 | Rectangle Worksurface 72"W x 24"D | HNLRC2472 | \$402 | \$1,206 |
| 3 | L-Shaped End Panel, Left 15¾"W x 24"D x 28½"H | HNLLEP2428L | \$364 | \$1,092 |
| 3 | Shelf/Box/Box/Lateral File Pedestal 30"W x 23⅜"D x 28½"H | HNL233028PSL | \$1,336 | \$4,008 |
| 3 | Modesty/Pedestal Back Panel 30"W x 27⅞"H | HNLMP3028 | \$192 | \$576 |
| 3 | Wall Mount Storage, Frosted Doors with Silver Frame 72"W x 15"D x 15"H | HNL1572FD | \$1,961 | \$5,883 |
| TOTAL: | | | \$17,460 | |

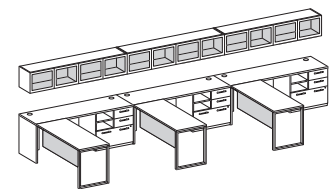

L-WORKSTATIONS – OPEN PLAN

CONCINNITY™

Typicals



Icon Legend on page 19

| QTY | DESCRIPTION | MODEL | LIST PRICE | PRICE EXTENSION |
|---------------|--|--------------|----------------|-----------------|
| 1 | Rectangle Worksurface with Vertical Grain 48"W x 24"D | HNLRC2448V | \$302 | \$302 |
| 1 | O-Leg Support for 48"W x 24"D Worksurface 24"D x 28½"H | HLSL2428O | \$357 | \$357 |
| 1 | Rectangle Worksurface 96"W x 24"D | HNLRC2496 | \$583 | \$583 |
| 1 | Storage Cabinet Pedestal 36"W x 23⅞"D x 28½"H | HNL233628PSC | \$887 | \$887 |
| 1 | End Panel, Left 1⅞"W x 23⅞"D x 28½"H | HNL2428EL | \$224 | \$224 |
| 1 | Modesty/Back Panel — Full-Length 96"W x 27⅞"H | HNLMP9628 | \$471 | \$471 |
| 1 | Bookcase Hutch, Frosted Doors with Silver Frame 36"W x 15"D x 48⅝"H | HNL4936BHFD | \$1,854 | \$1,854 |
| 1 | Wall Mount Storage, Frosted Doors with Silver Frame 60"W x 15"D x 28½"H | HNL2960FD | \$2,449 | \$2,449 |
| 1 | Vertical Paper Manager | HLVPM1 | \$351 | \$351 |
| 1 | Storage Tower, Wardrobe Right, Cabinet Left 24"W x 24"D x 78⅞"H | HNL242465TLR | \$2,445 | \$2,445 |
| TOTAL: | | | \$9,923 | |

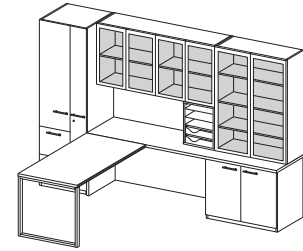

WORKSTATION WITH WORKWALL — OPEN PLAN

| QTY | DESCRIPTION | MODEL | LIST PRICE | PRICE EXTENSION |
|---------------|--|----------------|-----------------|-----------------|
| 4 | Rectangle Worksurface 60"W x 24"D | HNLRC2460 | \$358 | \$1,432 |
| 4 | Shelf/Box/Box/File Pedestal 15¾"W x 23⅞"D x 41"H | HNL231641PSBBF | \$1,645 | \$6,580 |
| 4 | Full Back Panel — For 15¾"W Pedestal 15¾"W x 40⅝"H | HNL231641 | \$168 | \$672 |
| 4 | Narrow Box/Box/File/File Pedestal 9½"W x 23⅞"D x 41"H | HNL231041PBFF | \$1,446 | \$5,784 |
| 4 | Full Back Panel — For 9½"W Pedestal 9½"W x 40⅝"H | HNL231041 | \$153 | \$612 |
| 2 | Above/Below Privacy Screen, Frosted 30"W x 28"H | HLSL2830 | \$896 | \$1,792 |
| 2 | 5-Shelf Bookcase with Coat Hooks, Right 24"W x 24"D x 64¾"H | HNL2424BK5CR | \$1,048 | \$2,096 |
| 2 | 5-Shelf Bookcase with Coat Hooks, Left 24"W x 24"D x 64¾"H | HNL2424BK5CL | \$1,048 | \$2,096 |
| TOTAL: | | | \$21,064 | |

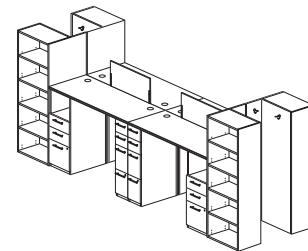

STANDING-HEIGHT — TEAMING WORKSTATION — OPEN PLAN

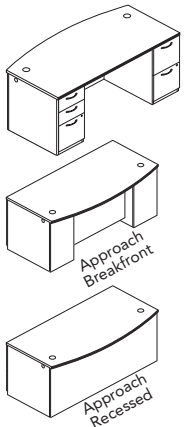

| DESCRIPTION | APPROACH SIDE OVERHANG | MODEL | SHIP WEIGHT | CUBE | L1 LIST | L2 UPCHARGES | | |
|---|------------------------|---------------------|-------------|------|---------------|--------------|-------------|-------------|
| | | | | | | WORKSURFACES | CHASSIS | FRONTS |
| Double Pedestal Desk — Bow Top 72"W x 36"D x 29½"H, Recessed Modesty Panel | 6" | HNL3672DPBR | 298 | 51.8 | \$2525 | \$25 | \$40 | \$10 |
| 72"W x 36"D x 29½"H, Breakfront Modesty Panel | 6-12" | HNL3672DPBB | 282 | 51.8 | \$2625 | \$25 | \$40 | \$10 |
| 72"W x 36"D x 29½"H, Breakfront Frosted Modesty Panel | 6-12" | HNL3672DPBBF | 266 | 51.8 | \$3153 | \$25 | \$40 | \$10 |

NOTES: For laminate center drawer, see page 104. For pull-out collaborative shelf, for desks with breakfront modesty panel, see page 104.

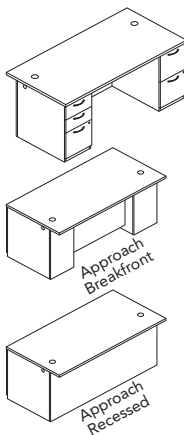

| | | | | | | | | |
|--|-------|---------------------|-----|------|---------------|-------------|-------------|-------------|
| Double Pedestal Desk — Rectangle Top 72"W x 36"D x 29½"H, Rectangle Top, Recessed Modesty Panel | 6" | HNL3672DPRR | 292 | 51.8 | \$2137 | \$25 | \$40 | \$10 |
| 66"W x 30"D x 29½"H, Rectangle Top, Flush Modesty Panel | | HNL3066DPRF | 267 | 40.2 | \$2011 | \$20 | \$35 | \$10 |
| 60"W x 30"D x 29½"H, Rectangle Top, Flush Modesty Panel | | HNL3060DPRF | 257 | 40.2 | \$1880 | \$20 | \$45 | \$20 |
| 72"W x 36"D x 29½"H, Rectangle Top, Breakfront Modesty Panel | 6-12" | HNL3672DPRB | 287 | 51.8 | \$2379 | \$25 | \$40 | \$10 |
| 72"W x 36"D x 29½"H, Rectangle Top, Breakfront Frosted Modesty Panel | 6-12" | HNL3672DPRBF | 270 | 51.8 | \$2907 | \$25 | \$40 | \$10 |

NOTES: For laminate center drawer, see page 104. For pull-out collaborative shelf, for desks with breakfront modesty panel, see page 104.

NOTES:

- Feature full-to-the-floor pedestals to maximize storage space.
- Double pedestal desks have 3/2 drawer configuration (box/box/file on left pedestal, file/file on right pedestal).
- Single pedestal desks have a box/box/file pedestal.
- One molded black pencil tray is included in each box/box/file pedestal.
- 72"W models are available with Rectangle- or bow-shaped tops.
- Bow top desk models measure 36"D at the crest and 30"D along the end panels.
- Formal breakfront or recessed modesty panel.
- Breakfront desk features a floating modesty panel which can be specified in laminate or frosted material. Floating design provides space for optional pull-out collaborative shelf for visitors. See page 104.
- Recessed modesty panel design has a full-width conference overhang, providing worksurface and kneespace for guests.
- 66"W and 60"W desks have a flush modesty panel (i.e., no conference overhang).
- Two cord management grommets, for routing and hiding wires and cables, are located in desktops.
- Grommets can be replaced with optional Power (model HGRMTAC) or USB Hub (HGRMTUSB2).
- Pedestal sides and end panels are standard with pass-through grommets to enable the routing of cords below the worksurface, and connections between workstations.
- Specification logic includes the grommet finish for tops; choose from Black (P) or Platinum (T1). Side grommets on pedestal are black only.
- See "Modular Components" for cord management options. Worksurfaces/tops, end and modesty panels, and pedestals can be specified with or without grommets.
- Finish of pedestal lock(s) is determined by, and aligned with, the handle finish specified.
- Adjustable hex leveling glides.
- Ship fully assembled.

HOW TO SPECIFY

| | | | | | | |
|----------------------------|---|---|---|---------------------------------|-----------------------------|----------------------------------|
| Select Model Number | Select Edge Profile and Edge Color | Select Handle | Select Worksurface Grommet Finish | Select Worksurface Color | Select Chassis Color | Select Drawer Front Color |
| See page 29 | See page 29 | <p>A Cylinder – Satin B Cylinder – Black C Canopy – Satin D Canopy – Black E Loop – Satin F Loop – Black</p> | <p>P Black T1 Platinum</p> | See page 29 | See page 29 | See page 29 |
| HNL3672DPBR | BH | E | T1 | H | H | H |

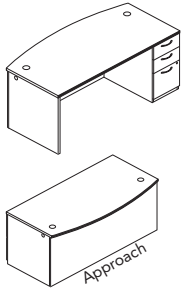

| DESCRIPTION | APPROACH SIDE OVERHANG | MODEL | SHIP WEIGHT | CUBE | L1 LIST | L2 UPCHARGES | | |
|---|---------------------------|---------------------|----------------|------|---------------|--------------|-------------|-------------|
| | | | | | | WORKSURFACES | CHASSIS | FRONTS |
| Single Pedestal Desk — Bow Top 72"W x 36"D x 29½"H, Right, Recessed Modesty Panel (shown) | 6" | HNL3672RPBR | 238 | 51.8 | \$2029 | \$25 | \$40 | \$10 |
| 72"W x 36"D x 29½"H, Left, Recessed Modesty Panel | 6" | HNL3672LPBR | 238 | 51.8 | \$2029 | \$25 | \$40 | \$10 |
| 72"W x 36"D x 29½"H, Right, Breakfront Modesty Panel | 6-12" | HNL3672RPBB | 237 | 51.8 | \$2288 | \$25 | \$40 | \$10 |
| 72"W x 36"D x 29½"H, Left, Breakfront Modesty Panel | 6-12" | HNL3672LPBB | 237 | 51.8 | \$2288 | \$25 | \$40 | \$10 |
| 72"W x 36"D x 29½"H, Right, Breakfront Frosted Modesty Panel | 6-12" | HNL3672RPBBF | 221 | 51.8 | \$2805 | \$25 | \$40 | \$10 |
| 72"W x 36"D x 29½"H, Left, Breakfront Frosted Modesty Panel | 6-12" | HNL3672LPBBF | 221 | 51.8 | \$2805 | \$25 | \$40 | \$10 |

NOTES: For laminate center drawer, see page 104. For pull-out collaborative shelf, for desks with breakfront modesty panel, see page 104.

NOTES:

- Feature full-to-the-floor pedestals to maximize storage space.
- Double pedestal desks have 3/2 drawer configuration (box/box/file on left pedestal, file/file on right pedestal).
- Single pedestal desks have a box/box/file pedestal.
- One molded black pencil tray is included in each box/box/file pedestal.
- 72"W models are available with Rectangle- or bow-shaped tops.
- Bow top desk models measure 36"D at the crest and 30"D along the end panels.
- Formal breakfront or recessed modesty panel.
- Breakfront desk features a floating modesty panel which can be specified in laminate or frosted material. Floating design provides space for optional pull-out collaborative shelf for visitors. See page 104.
- Recessed modesty panel design has a full-width conference overhang, providing workspace and kneespace for guests.
- 66"W and 60"W desks have a flush modesty panel (i.e., no conference overhang).
- Two cord management grommets, for routing and hiding wires and cables, are located in desktops.
- Grommets can be replaced with optional Power (model HGRMTAC) or USB Hub (HGRMTUSB2).
- Pedestal sides and end panels are standard with pass-through grommets to enable the routing of cords below the workspace, and connections between workstations.
- Specification logic includes the grommet finish for tops; choose from Black (P) or Platinum (TI). Side grommets on pedestal are black only.
- See "Modular Components" for cord management options. Worksurfaces/tops, end and modesty panels, and pedestals can be specified with or without grommets.
- Finish of pedestal lock(s) is determined by, and aligned with, the handle finish specified.
- Adjustable hex leveling glides.
- Ship fully assembled.

HOW TO SPECIFY

| Select Model Number | Select Edge Profile and Edge Color | Select Handle | Select Worksurface Grommet Finish | Select Worksurface Color | Select Chassis Color | Select Drawer Front Color |
|------------------------------|------------------------------------|---------------|-----------------------------------|--------------------------|----------------------|---------------------------|
| See page 29 | See page 29 | See page 29 | See page 29 | See page 29 | See page 29 | See page 29 |
| H N L 3 6 7 2 R P B R | B H | E | T I | H | H | H |

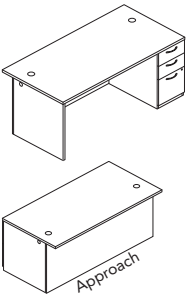

Icon Legend on page 19

| DESCRIPTION | APPROACH SIDE OVERHANG | MODEL | SHIP WEIGHT | CUBE | L1 LIST | L2 UPCHARGES | | |
|--|------------------------|---------------------|-------------|------|---------------|--------------|-------------|-------------|
| | | | | | | WORKSURFACES | CHASSIS | FRONTS |
|  <p>Single Pedestal Desk — Rectangle Top 72"W x 36"D x 29½"H, Right, Recessed Modesty Panel (shown) 72"W x 36"D x 29½"H, Left, Recessed Modesty Panel 66"W x 30"D x 29½"H, Right, Flush Modesty Panel 66"W x 30"D x 29½"H, Left, Flush Modesty Panel 72"W x 36"D x 29½"H, Right, Breakfront Modesty Panel 72"W x 36"D x 29½"H, Left, Breakfront Modesty Panel 72"W x 36"D x 29½"H, Right, Breakfront Frosted Modesty Panel 72"W x 36"D x 29½"H, Left, Breakfront Frosted Modesty Panel</p> | 6" | HNL3672RPRR | 242 | 51.8 | \$1753 | \$25 | \$40 | \$10 |
| | 6" | HNL3672LPRR | 242 | 51.8 | \$1753 | \$25 | \$40 | \$10 |
| | | HNL3066RPRF | 217 | 40.2 | \$1711 | \$20 | \$35 | \$10 |
| | | HNL3066LPRF | 217 | 40.2 | \$1711 | \$20 | \$35 | \$10 |
| | 6-12" | HNL3672RPRB | 242 | 51.8 | \$2090 | \$25 | \$40 | \$10 |
| | 6-12" | HNL3672LPRB | 242 | 51.8 | \$2090 | \$25 | \$40 | \$10 |
| | 6-12" | HNL3672RPRBF | 225 | 51.8 | \$2608 | \$25 | \$40 | \$10 |
| | 6-12" | HNL3672LPRBF | 225 | 51.8 | \$2608 | \$25 | \$40 | \$10 |

NOTES: For laminate center drawer, see page 104. For pull-out collaborative shelf, for desks with breakfront modesty panel, see page 104.

NOTES:

- Feature full-to-the-floor pedestals to maximize storage space.
- Double pedestal desks have 3/2 drawer configuration (box/box/file on left pedestal, file/file on right pedestal).
- Single pedestal desks have a box/box/file pedestal.
- One molded black pencil tray is included in each box/box/file pedestal.
- 72"W models are available with Rectangle- or bow-shaped tops.
- Bow top desk models measure 36"D at the crest and 30"D along the end panels.
- Formal breakfront or recessed modesty panel.
- Breakfront desk features a floating modesty panel which can be specified in laminate or frosted material. Floating design provides space for optional pull-out collaborative shelf for visitors. See page 104.
- Recessed modesty panel design has a full-width conference overhang, providing workspace and kneespace for guests.
- 66"W and 60"W desks have a flush modesty panel (i.e., no conference overhang).
- Two cord management grommets, for routing and hiding wires and cables, are located in desktops.
- Grommets can be replaced with optional Power (model HGRMTAC) or USB Hub (HGRMTUSB2).
- Pedestal sides and end panels are standard with pass-through grommets to enable the routing of cords below the worksurface, and connections between workstations.
- Specification logic includes the grommet finish for tops; choose from Black (P) or Platinum (T1). Side grommets on pedestal are black only.
- See "Modular Components" for cord management options. Worksurfaces/tops, end and modesty panels, and pedestals can be specified with or without grommets.
- Finish of pedestal lock(s) is determined by, and aligned with, the handle finish specified.
- Adjustable hex leveling glides.
- Ship fully assembled.

HOW TO SPECIFY

| | | | | | | |
|--|---|---|---|---|---|--|
| <p>Select Model Number</p> <p>See page 29</p> <p>H N L 3 6 7 2 R P R R</p> | <p>Select Edge Profile and Edge Color</p> <p>See page 29</p> <p>B H</p> | <p>Select Handle</p> <p>A Cylinder – Satin B Cylinder – Black C Canopy – Satin D Canopy – Black E Loop – Satin F Loop – Black</p> <p>E</p> | <p>Select Worksurface Grommet Finish</p> <p>P Black T1 Platinum</p> <p>T 1</p> | <p>Select Worksurface Color</p> <p>See page 29</p> <p>H</p> | <p>Select Chassis Color</p> <p>See page 29</p> <p>H</p> | <p>Select Drawer Front Color</p> <p>See page 29</p> <p>H</p> |
|--|---|---|---|---|---|--|

CONCINNITY™ Peninsulas

GSA SIN 33721



Icon Legend on page 19

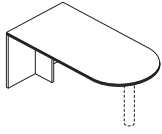

Support column sold separately



| DESCRIPTION | MODEL | SHIP WEIGHT | CUBE | L1 LIST | L2 UPCHARGES | |
|--|--------------------|-------------|------|--------------|--------------|-------------|
| | | | | | WORKSURFACE | CHASSIS |
| Bullet Peninsula with End Panel | | | | | | |
| 72"W x 36"D x 29½"H | HNL3672BUEP | 131 | 6.6 | \$983 | \$25 | \$40 |
| 72"W x 30"D x 29½"H | HNL3072BUEP | 112 | 5.6 | \$857 | \$20 | \$25 |
| 66"W x 30"D x 29½"H | HNL3066BUEP | 105 | 5.1 | \$768 | \$20 | \$35 |

NOTES: For use in "U" or "L" shaped furniture layouts; not to be used freestanding. Comprised of top and end/brace panels (Note: Must specify support column; sold separately). Cord routing notch in the brace panel. Adjustable hex leveling glides. For cord grommet options, see "Modular Components". Options include center drawers and modesty panels. Modesty panel is available in laminate or frosted material. Ships

Not designed to be used freestanding.

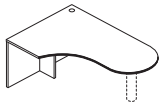
Right-hand model
HNL4872JREP shown

Support column sold separately



| | | | | | | |
|---------------------------------------|--------------------|-----|------|---------------|-------------|-------------|
| Jetty Peninsula with End Panel | | | | | | |
| 72"W x 30/48"D x 29½"H, Right | HNL4872JREP | 147 | 8.9 | \$1181 | \$30 | \$25 |
| 72"W x 30/48"D x 29½"H, Left | HNL4872JLEP | 147 | 8.9 | \$1181 | \$30 | \$25 |
| 72"W x 30/42"D x 29½"H, Right | HNL4272JREP | 134 | 17.0 | \$1099 | \$30 | \$25 |
| 72"W x 30/42"D x 29½"H, Left | HNL4272JLEP | 134 | 17.0 | \$1099 | \$30 | \$25 |

NOTES: Worksurface designed and sized to efficiently serve as both a computing and conferencing space. Two sizes, 42"D and 48"D. The 48"D unit is specifically intended to be used with the 48"D extended corner modular top/back components to form a two-piece U-shaped workstation with a 42" cockpit area. For use in "U" or "L" shaped furniture layouts; not to be used freestanding. Comprised of top and end/brace panels (Note: Must specify support column; sold separately). One cord management grommet in the top; cord routing notch in the brace panel. Adjustable hex leveling glides. Field installable modesty panel is optional. Ships

Not designed to be used freestanding.

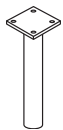

| DESCRIPTION | MODEL | SHIP WEIGHT | CUBE | LIST PRICE |
|--|----------------|-------------|------|--------------|
| Support Column for Bullet and Jetty Peninsulas 3" Diameter. Specify: HPC190X.P. Black only. | HPC190X | 12 | 1.0 | \$173 |
| Support Column for Bullet and Jetty Peninsulas 3" Diameter. Specify: HPC191X.X. Available in Silver only. | HPC191X | 12 | 1.0 | \$173 |

Support Column must be specified/ordered with Bullet and Jetty peninsulas.



NOTES:

- See pages 90-94 for shared components.

HOW TO SPECIFY

| | | | | |
|---|---|--|---|---|
| Select Model Number H N L 3 6 7 2 B U E P | Select Edge Profile and Edge Color See page 29 B H | Select Worksurface Color See page 29 H | Select Chassis Color See page 29 H | |
| Select Model Number H N L 4 8 7 2 J R E P | Select Edge Profile and Edge Color See page 29 B H | Select Worksurface Grommet Finish P Black T1 Platinum | Select Worksurface Color See page 29 H | Select Chassis Color See page 29 H |



| | DESCRIPTION | MODEL | SHIP WEIGHT | CUBE | LIST PRICE BY PAINT GRADE | | |
|---|---|----------------|-------------|------|---------------------------|--------------|--------------|
| | | | | | P1 | P2 | P3 |
|  | Post Leg Base 28½" H x 2" square NOTES: Can only be used as the outbound support in a peninsula or island extension worksurface application. Glides have 2" of adjustability. Ship 1/pack. SPECIFYING EXAMPLE: HLSL28P.T1 | HLSL28P | 15 | 1.0 | \$321 | \$325 | \$341 |
|  | Field Installable Modesty Panel for Bullet and Jetty Peninsulas, Laminate (Vertical Grain) 50¼"W x ¾" Thick x 18"H NOTES: Center drawer model H1522 can be used in conjunction with laminate modesty panel model HPC180W. Cord pass-through notch in top corner. SPECIFYING EXAMPLE: HPC180W.H | HPC180W | | 28 | | 3.6 | \$232 |
|  | Field Installable Modesty Panel for Bullet and Jetty Peninsulas, Frosted with Silver Frame 50¼"W x ¾" Thick x 18"H ⚠ Cord pass-through notch is not available on the Frosted/Silver model HPC180G. Notch is on laminate model HPC180W only. ⚠ Center drawers not designed to be used with the frosted/silver modesty panel model HPC180G. | HPC180G | | 33 | | 1.5 | \$745 |

NOTES:

- See pages 90-94 for shared components.

HOW TO SPECIFY

Select
Model Number

H L S L 2 8 P

CONCINNITY™

Corner Unit

GSA SIN 33721



Icon Legend on page 19

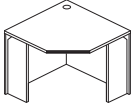

| DESCRIPTION | MODEL | SHIP WEIGHT | CUBE | L1 LIST | L2 UPCHARGES | |
|---|------------------|-------------|------|---------------|--------------|-------------|
| | | | | | WORKSURFACE | CHASSIS |
| Corner Unit 24"W x 36"D x 24" x 29½"H | HNL3636CU | 109 | 26.4 | \$1034 | \$15 | \$20 |

NOTES: Designed for use with 24"D returns or bridges. Can be used freestanding. Can be used with two 36"W modular returns to achieve an efficient 6' x 6' layout. One cord management grommet in the top; cord routing notches in the leg panels. The worksurface grommet can be replaced with optional power (model HGRMTAC) or USB (model HGRMTUSB2) hub. Adjustable hex leveling glides. When connected to a 42"W return or modular return, the 78"W stack-on storage unit spans the total depth dimension (78"D). When connected to a 36"W modular return, the 72"W stack-on storage unit spans the total depth dimension (72"D). Edgebanding on the corner unit is profiled on the user's side and flat on the back (approach side) and ends. Ships fully assembled.

NOTES:

- For Extended Corner Worksurface sizes, see "Modular Components" on page 76.

HOW TO SPECIFY

Select
Model Number

H N L 3 6 3 6 C U .

Select
Edge Profile and Edge
Color

See page 29

B H .

Select
Worksurface Grommet
Finish

P Black
T1 Platinum

P .

Select
Worksurface Color

See page 29

H .

Select
Chassis Color

See page 29

H

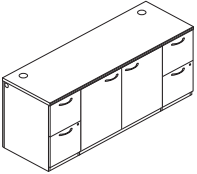
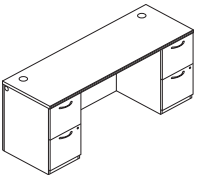
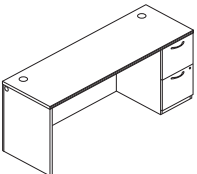
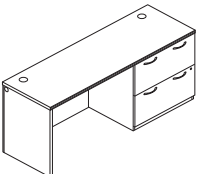

| DESCRIPTION | MODEL | SHIP WEIGHT | CUBE | L1 LIST | L2 UPCHARGES | | |
|---|-------------------|-------------|------|---------------|--------------|-------------|-------------|
| | | | | | WORKSURFACES | CHASSIS | FRONTS |
|  <p>Credenza with Storage 72"W x 24"D x 29½"H</p> <p>NOTES: For use behind a desk or as a stand-alone storage piece. Four file drawers, 2-left, 2-right and one storage cabinet with hinged doors. One adjustable shelf, which adjusts in 2½" increments, behind doors. Drawers lock. Finish of locks is determined by, and aligned with, the handle finish specified. Storage cabinet doors are non-locking.</p> | HNL2472DPS | 323 | 35.6 | \$2628 | \$20 | \$45 | \$40 |
| | | | | | | | |
|  <p>Credenza with Kneespace 72"W x 24"D x 29½"H 66"W x 24"D x 29½"H 60"W x 24"D x 29½"H</p> <p>NOTES: For use behind a desk or as a stand-alone storage piece. Four locking file drawers, 2-left, 2-right. Finish of locks determined by, and aligned with, the handle finish specified.</p> | HNL2472DPK | 247 | 35.6 | \$1989 | \$20 | \$40 | \$20 |
| | HNL2466DPK | 239 | 32.7 | \$1898 | \$20 | \$40 | \$20 |
| | HNL2460DPK | 230 | 29.9 | \$1867 | \$20 | \$35 | \$20 |
|  <p>Credenza, Single Pedestal 72"W x 24"D x 29½"H, Right 72"W x 24"D x 29½"H, Left</p> <p>NOTES: Primary use is as part of a connected U-shaped workstation with a bridge and single pedestal desk. Two locking file drawers. Finish of lock determined by, and aligned with, the handle finish specified. Can be used with modular or mobile pedestals.</p> | HNL2472RP | 199 | 35.6 | \$1586 | \$20 | \$35 | \$10 |
| | HNL2472LP | 199 | 35.6 | \$1586 | \$20 | \$35 | \$10 |
|  <p>Credenza with Lateral File 72"W x 24"D x 29½"H, Right 72"W x 24"D x 29½"H, Left</p> <p>NOTES: Storage file measures 30"W (36"W can be specified using modular components). Mechanical interlock inhibits the extension of more than one drawer at a time. Finish of lock is determined by, and aligned with, the handle finish specified. Can be used with modular or mobile pedestals.</p> | HNL2472RLC | 245 | 35.6 | \$1733 | \$20 | \$35 | \$20 |
| | HNL2472LLC | 245 | 35.6 | \$1733 | \$20 | \$35 | \$20 |

NOTES:

- Optional 72"W, 66"W and 60"W stack-on sizes maximize storage space.
- Two cord management grommets, for routing and hiding wires and cables, are located in top.
- Modesty panel and pedestal grommets are black only.
- A cord pass-through grommet is located in the sides of the pedestal and top center of the back (modesty panel) to facilitate reaching wall electrical outlets.
- Specification logic includes the grommet finish for tops; choose from Black (P) or Platinum (TI).
- Worksurfaces/tops, end and modesty panels, and pedestals can be specified with or without grommets. See "Modular Components" on page 34 for cord management options.
- For paper organizers, see page 108.

HOW TO SPECIFY

| Select Model Number | Select Edge Profile and Edge Color | Select Handle | Select Worksurface Grommet Finish | Select Worksurface Color | Select Chassis Color | Select Drawer Front Color |
|----------------------------|------------------------------------|---------------|-----------------------------------|--------------------------|----------------------|---------------------------|
| See page 29 | See page 29 | See page 29 | See page 29 | See page 29 | See page 29 | See page 29 |
| H N L 2 4 7 2 D P S | B H | E | T I | H | H | H |

CONCINNITY™ Low Credenzas

GSA SIN 33721



Icon Legend on page 19

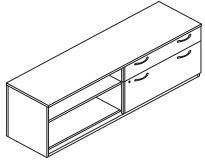

| DESCRIPTION | MODEL | SHIP WEIGHT | CUBE | L1 LIST | L2 UPCHARGES | | |
|---|---------------------|-------------|------|---------------|--------------|-------------|-------------|
| | | | | | WORKSURFACES | CHASSIS | FRONTS |
| Low Credenza (Bench-Height) 72"W x 20"D x 21½"H, Drawers Right, Bookcase Left (shown) | HNL207221RD2 | 219 | 21.6 | \$1541 | \$15 | \$25 | \$20 |
| 72"W x 20"D x 21½"H, Drawers Left, Bookcase Right | HNL207221LD2 | 219 | 21.6 | \$1541 | \$15 | \$25 | \$20 |
| 60"W x 20"D x 21½"H, Drawers Right, Bookcase Left | HNL206021RD2 | 187 | 18.1 | \$1384 | \$20 | \$15 | \$20 |
| 60"W x 20"D x 21½"H, Drawers Left, Bookcase Right | HNL206021LD2 | 187 | 18.1 | \$1384 | \$20 | \$15 | \$20 |

NOTES: Combination storage design comprised of two locking drawers (1-box/supply and 1-file) plus a bookcase. File drawers include integrated hangrails for letter- or legal-sized folders. Bookcase has one adjustable shelf; adjusts in 2½" increments.

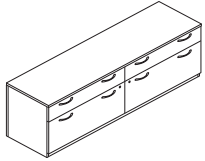

| | | | | | | | |
|--|--------------------|-----|------|---------------|-------------|-------------|-------------|
| Low Credenza, 2 Box/2 File 72"W x 20"D x 21½"H | HNL207221D4 | 308 | 21.6 | \$1874 | \$15 | \$25 | \$40 |
| 60"W x 20"D x 21½"H | HNL206021D4 | 260 | 18.1 | \$1660 | \$15 | \$20 | \$40 |

NOTES: Four locking drawers (2-box/supply and 2-file). File drawers include integrated hangrails for letter- or legal-sized folders.

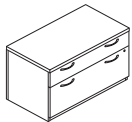

| | | | | | | | |
|--|--------------------|-----|------|---------------|-------------|-------------|-------------|
| Low Credenza, Box/File 36"W x 20"D x 21½"H | HNL203621D2 | 143 | 11.8 | \$1086 | \$10 | \$15 | \$20 |
| 30"W x 20"D x 21½"H | HNL203021D2 | 121 | 10.0 | \$1020 | \$10 | \$15 | \$20 |

NOTES: Unit contains two drawers, one box and one lateral file.

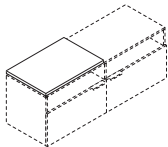

| DESCRIPTION | MODEL | SHIP WEIGHT | CUBE | LIST PRICE BY FABRIC GRADE | | | | | |
|---|--------------------|-------------|------|----------------------------|--------------|--------------|--------------|--------------|--------------|
| | | | | 1 | 2 | 3 | 4 | 5 | 6 |
| Credenza Cushion 36"W x 20"D x 1"H for 72" and 36"W Low Credenzas | HLSL2036CH2 | 11 | 2.2 | \$451 | \$489 | \$527 | \$566 | \$615 | \$665 |
| 30"W x 20"D x 1"H for 60" and 30"W Low Credenzas | HLSL2030CH2 | 9 | 1.9 | \$418 | \$454 | \$490 | \$526 | \$572 | \$619 |

NOTES: See pages 22-24 for available fabrics.

Seat cushions are optional; HLSL2036CH2 for 72" and 36"W, HLSL2030CH2 for 60" and 30"W.

! For model HLSL2030CH2 must order two cushions to cover entire 60" Credenza surface.

SPECIFYING EXAMPLE: HLSL2036CH2.APN23

NOTES:

- Versatile, space-saving solutions double as a compact storage unit and convenient bench seat.
- When combined with 29½"H worksurfaces, the 21½"H credenzas can be positioned to create multi-level, overlapping surfaces that optimize floor space, organization and display needs.
- The distinct, clean horizontal planes provide a light scale, layered look.
- Low-heights help facilitate team collaboration.
- Finish of lock(s) is determined by, and aligned with, the handle finish specified.
- Overlapping surfaces can be supported by a 28½"H or 7"H O-leg or 7"H laminate end panel.

HOW TO SPECIFY

| | | | | | |
|--|--|---|--|--|---|
| <p>Select Model Number</p> <p>H N L 2 0 7 2 2 1 R D 2 .</p> | <p>Select Edge Profile and Edge Color</p> <p>See page 29</p> <p>B H .</p> | <p>Select Handle</p> <p>A Cylinder - Satin B Cylinder - Black C Canopy - Satin D Canopy - Black E Loop - Satin F Loop - Black</p> <p>E .</p> | <p>Select Top Color</p> <p>See page 29</p> <p>H .</p> | <p>Select Chassis Color</p> <p>See page 29</p> <p>H .</p> | <p>Select Drawer Front Color</p> <p>See page 29</p> <p>H .</p> |
|--|--|---|--|--|---|

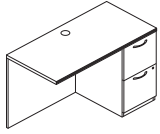

| DESCRIPTION | MODEL | SHIP | | L1 LIST | L2 UPCHARGES | | |
|------------------------------------|------------------|--------|------|---------------|--------------|-------------|-------------|
| | | WEIGHT | CUBE | | WORKSURFACES | CHASSIS | FRONTS |
| Return | | | | | | | |
| 48"W x 24"D x 29½"H, Right (shown) | HNL2448RP | 141 | 24.8 | \$1138 | \$15 | \$15 | \$10 |
| 48"W x 24"D x 29½"H, Left | HNL2448LP | 141 | 24.8 | \$1138 | \$15 | \$15 | \$10 |
| 42"W x 24"D x 29½"H, Right | HNL2442RP | 132 | 22.0 | \$1090 | \$15 | \$15 | \$10 |
| 42"W x 24"D x 29½"H, Left | HNL2442LP | 132 | 22.0 | \$1090 | \$15 | \$15 | \$10 |

NOTES: For L-shaped workstations. Connects to single pedestal desk, peninsula (bullet or jetty), or component worksurface with end panel. Drawers lock. Finish of lock is determined by, and aligned with, the handle finish specified. Formal, full-height modesty panel. One cord grommet in top for routing and hiding wires and cables. One cord pass-through grommet is located in the sides of the pedestal and top center of the back (modesty panel) to facilitate reaching wall electrical outlets. Specification logic includes the grommet finish for tops; choose from Black (P) or Platinum (TI). Modesty panel and pedestal grommets are black only. Edgebanding on 42"W and 48"W returns is profiled on the user's side and flat on the back (approach side) and ends. Woodgrain direction on worksurface runs vertical (i.e., front-to-back). Smaller and larger return sizes can be specified using modular worksurface and modesty panel components. Optional stack-on solutions maximize storage space. Ship fully assembled.

See chart on page 34 for cord management options. Worksurfaces/tops, end and modesty panels, and pedestals can be specified with or without grommets. For easy access to wall electrical outlets, options include a short (10") modesty panel or no back panel.

For paper organizers, see page 108.

HOW TO SPECIFY

| | | | | | | |
|-----------------------------------|---|---|---|---|---|--|
| <p>Select Model Number</p> | <p>Select Edge Profile and Edge Color</p> <p>See page 29</p> | <p>Select Handle</p> <p>A Cylinder – Satin B Cylinder – Black C Canopy – Satin D Canopy – Black E Loop – Satin F Loop – Black</p> | <p>Select Worksurface Grommet Finish</p> <p>P Black TI Platinum</p> | <p>Select Worksurface Color</p> <p>See page 29</p> | <p>Select Chassis Color</p> <p>See page 29</p> | <p>Select Drawer Front Color</p> <p>See page 29</p> |
| <p>H N L 2 4 4 8 R P .</p> | <p>B H .</p> | <p>E .</p> | <p>T I .</p> | <p>H .</p> | <p>H .</p> | <p>H .</p> |

CONCINNITY™ Bridges

GSA SIN 33721



Icon Legend on page 19

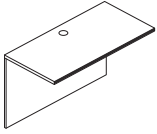

| DESCRIPTION | MODEL | SHIP WEIGHT | CUBE | L1 LIST | L2 UPCHARGES | | |
|--------------------------------------|------------------|-------------|------|--------------|--------------|-------------|------------|
| | | | | | WORKSURFACES | CHASSIS | FRONTS |
| Bridge 48"W x 24"D x 29½"H | HNL2448BF | 71 | 3.0 | \$491 | \$15 | \$15 | N/A |
| 42"W x 24"D x 29½"H | HNL2442BF | 62 | 2.5 | \$469 | \$15 | \$15 | N/A |

NOTES: For U-shaped workstation layouts. Connects single pedestal desk, peninsula (bullet or jetty), or component worksurface to corner unit or to single pedestal credenza, credenza with lateral file, or rectangle worksurface. Formal, full-height modesty panel. One cord grommet in top for routing and hiding wires and cables. One cord pass-through grommet in top center of back (modesty panel). Specification logic includes the grommet finish for tops; choose from Black (P) or Platinum (T1). Clear inside depth 22⁷/₈"D. Edgebanding on 42"W and 48"W bridges is profiled on the user's side and flat on the back (approach side) and ends. Woodgrain direction on worksurface runs vertical (i.e., front-to-back). Additional sizes, including 30"W and 36"W for use with corner or extended corner units, as well as jetty peninsulas, can be specified using modular worksurface and modesty panel components. Ship — quick, simple assembly. See chart on page 34 for cord management options. Worksurfaces/tops and modesty panels can be specified with or without grommets. For easy access to wall electrical outlets, options include a short (10") modesty panel or no back panel.

HOW TO SPECIFY

| | | | | |
|--|--|---|--|--|
| <p>Select Model Number</p> <p>H N L 2 4 4 8 B F .</p> | <p>Select Edge Profile and Edge Color</p> <p>See page 29</p> <p>B H .</p> | <p>Select Worksurface Grommet Finish</p> <p>P Black T1 Platinum</p> <p>P .</p> | <p>Select Worksurface Color</p> <p>See page 29</p> <p>H .</p> | <p>Select Chassis Color</p> <p>See page 29</p> <p>H .</p> |
|--|--|---|--|--|

CONCINNITY™ STACK-ON STORAGE APPLICATIONS

STACK-ON STORAGE APPLICATIONS

78"W

- Spans full-width of 78"W modular credenza or return.
- Spans total depth dimension of "L" workstation configurations comprised of:
 - 48"W return or modular return attached to a 36"D single pedestal desk with a bow front (78"D).
 - NOTE: The 36"D single pedestal desk with bow front is 30"D along end panel.
 - 48"W return or modular return attached to a 30"D single pedestal desk, modular desk, or bullet peninsula (78"D).
 - 42"W return or modular return attached to a 36"D single pedestal desk with rectangle top, modular desk, or bullet peninsula (78"D).
 - 42"W return or modular return attached to a 36" corner unit or 36"D extended corner unit (78"D).
 - 36"W modular return attached to a 42"D jetty peninsula (78"D).
 - 30"W modular return attached to a 48"D jetty peninsula (78"D).
 - 30"W modular return attached to a 48"D extended corner unit (78"D).

72"W

- Spans full-width of 72"W desks with rectangle top, credenzas, extended corner units, or modular desk, credenza, or return.
- Spans total depth dimension of "L" workstation configurations comprised of:
 - 48"W return or modular return attached to a 24"D single pedestal credenza or modular credenza (72"D).
 - 42"W return or modular return attached to a 36"D single pedestal desk with a bow front (72"D).
 - NOTE: The 36"D single pedestal desk with bow front is 30"D along end panel.
 - 42"W return or modular return attached to a 30"D single pedestal desk, modular desk, or bullet peninsula (72"D).
 - 36"W modular return attached to a 36"D single pedestal desk with rectangle top, modular desk, or bullet peninsula (72"D).
 - 36"W modular return attached to a 36" corner unit or 36"D extended corner unit (72"D).
 - 30"W modular return attached to a 42"D jetty peninsula (72"D).

66"W

- Spans full-width of 66"W desk, credenza, or modular desk, credenza, or return.
- Spans total depth dimension of "L" workstation configurations comprised of:
 - 42"W return or modular return attached to a 24"D single pedestal credenza or modular credenza (66"D).

- 36"W modular return attached to a 30"D single pedestal desk, bullet peninsula, or modular desk (66"D).
- 36"W modular return attached to a 36"D single pedestal desk with a bow front (66"D).
 - NOTE: The 36"D single pedestal desk with bow front is 30"D along end panel.
- 30"W modular return attached to a 36"D single pedestal desk with rectangle top or modular desk (66"D).
- 30"W modular return attached to a 36" corner unit (66"D).

60"W

- Spans full-width of 60"W desk, credenza, or modular desk, credenza, or return.
- Spans total depth dimension of "L" workstation configurations comprised of:
 - 36"W modular return attached to a 24"D single pedestal credenza or modular credenza (60"D).
 - 30"W modular return attached to a 30"D single pedestal desk or modular desk (60"D).

48"W

- Spans full-width of 48"W return, modular return, or modular desk or credenza.
- Spans full-depth of the 48"D jetty peninsula or extended corner unit.

42"W

- Spans full-width of 42"W return, modular return, or modular desk or credenza.
- Spans full-depth of 42"D jetty peninsula.

36"W

- Spans full-width of 36"W modular return, modular desk or credenza, two drawer lateral file, or 29½"H storage cabinet with doors.
- Spans full-depth of 36"D desks with rectangle top, bullet peninsula, extended corner unit, or 36" corner unit.

OPTIONS INCLUDE:

- Door/Storage Options:

| Door(s) | Standard-Height | Executive-Height |
|------------------|-----------------|------------------|
| Laminate | • | • |
| Laminate Locking | • | • |
| Frosted/Silver | • | • |
| Sliding | • | • |

- Available in 35¼" or 78⅛"H; when positioned on 29½"H base unit, heights respectively align with 64¾" and 78⅛"H storage- and wardrobe-type cabinets.
- Paper organizers for stack-on and wall mounted storage cabinets (see application and compatibility information on page 109).

CONCINNITY™ STACK-ON STORAGE APPLICATIONS

- Fabric-Covered Tackboards:
 - Sized $\frac{3}{4}$ " narrower than the stack-on storage back enclosure, allowing $\frac{3}{8}$ " on each side to route task light cords.
 - Includes adhesive latch & hook tape for attachment to stack-on storage back panel and fasteners for wall mount applications.
 - For a list of standard fabrics, see pages 25-26. For a complete list of fabrics, please go to hon.com/fabricsandfinishes.
- Markerboards:
 - HLSL1530SOMB: 29 $\frac{1}{2}$ "W x 12 $\frac{1}{2}$ "H panel attaches to 60" and 66"W stack-on and wall mounted storage with sliding door models with double-sided tape.
 - HLSL1536SOMB: 35 $\frac{1}{2}$ "W x 12 $\frac{1}{2}$ "H panel attaches to 72" and 78"W stack-on and wall mounted storage with sliding door models with double-sided tape.
- Markerboards will not fit on stack-on storage laminate or laminate locking door models.
- Task Lights:
 - Attach to underside of stack-on and wall mount storage cabinets.
 - Fluorescent or LED options.
 - Tackboard and fluorescent and LED task light solutions, by model, for each stack-on storage size:

| Stack-on Storage | Tackboard | Fluorescent Task Light | LED Task Light |
|------------------|-----------|------------------------|--------------------|
| 78"W | H90057 | HH870960, HH870960CH | HLED31A, HLED31AUO |
| 72"W | H90056 | HH870960, HH870960CH | HLED31A, HLED31AUO |
| 66"W | H90055 | HH870960, HH870960CH | HLED31A, HLED17AUO |
| 60"W | H90054 | HH870960, HH870960CH | HLED31A, HLED17AUO |
| 48"W | H90053 | HH870942, HH870942CH | HLED31AS |
| 42"W | H90052 | HH870942, HH870942CH | HLED31AS |
| 36"W | H90051 | HH870930, HH870930CH | HLED17AS |



CONCINNITY™ Stack-on Storage

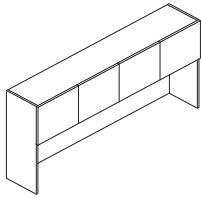

DESCRIPTION

Stack-on Storage, Laminate Doors
 78"W x 15"D x 35¼"H — 4 doors, 2 compartments
 72"W x 15"D x 35¼"H — 4 doors, 2 compartments
 66"W x 15"D x 35¼"H — 4 doors, 2 compartments
 60"W x 15"D x 35¼"H — 4 doors, 2 compartments
 48"W x 15"D x 35¼"H — 3 doors, 2 compartments
 42"W x 15"D x 35¼"H — 2 doors, 1 compartment
 36"W x 15"D x 35¼"H — 2 doors, 1 compartment

| MODEL | SHIP WEIGHT | CUBE | L1 LIST | L2 UPCHARGES | |
|-----------|-------------|------|---------|--------------|--------|
| | | | | CHASSIS | FRONTS |
| HNL3678LD | 173 | 31.8 | \$1446 | \$45 | \$20 |
| HNL3672LD | 162 | 29.0 | \$1387 | \$35 | \$20 |
| HNL3666LD | 151 | 26.7 | \$1369 | \$35 | \$20 |
| HNL3660LD | 139 | 24.3 | \$1248 | \$35 | \$20 |
| HNL3648LD | 117 | 19.6 | \$1126 | \$30 | \$20 |
| HNL3642LD | 100 | 18.1 | \$1099 | \$30 | \$10 |
| HNL3636LD | 88 | 15.3 | \$929 | \$30 | \$10 |

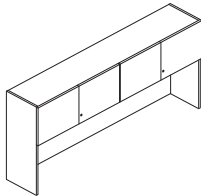

Stack-on Storage, Laminate Locking Doors
 78"W x 15"D x 35¼"H — 4 doors, 2 compartments
 72"W x 15"D x 35¼"H — 4 doors, 2 compartments
 66"W x 15"D x 35¼"H — 4 doors, 2 compartments
 60"W x 15"D x 35¼"H — 4 doors, 2 compartments
 48"W x 15"D x 35¼"H — 3 doors, 2 compartments
 42"W x 15"D x 35¼"H — 2 doors, 1 compartment
 36"W x 15"D x 35¼"H — 2 doors, 1 compartment

| | | | | | |
|-----------|-----|------|--------|------|------|
| HNL3678LL | 173 | 31.8 | \$1541 | \$45 | \$20 |
| HNL3672LL | 162 | 29.0 | \$1476 | \$35 | \$20 |
| HNL3666LL | 151 | 26.7 | \$1458 | \$35 | \$20 |
| HNL3660LL | 139 | 24.3 | \$1337 | \$35 | \$20 |
| HNL3648LL | 117 | 19.6 | \$1193 | \$30 | \$20 |
| HNL3642LL | 100 | 18.1 | \$1143 | \$30 | \$10 |
| HNL3636LL | 88 | 15.3 | \$974 | \$30 | \$10 |

! Lock available in Black (P) or Satin (SA) finish. Lock is core removable. Keyed alike cores must be ordered separately. For stack-on and wall mount storage with locking hinged doors, specify model HF27B (Black) or HF27S (Satin) and the key number, see page 110. Model HNL3648LL has one lock, which secures two of the three doors.

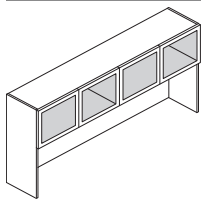

Stack-on Storage, Frosted Doors with Silver Frame

78"W x 15"D x 35¼"H — 4 doors, 2 compartments
 72"W x 15"D x 35¼"H — 4 doors, 2 compartments
 66"W x 15"D x 35¼"H — 4 doors, 2 compartments
 60"W x 15"D x 35¼"H — 4 doors, 2 compartments
 48"W x 15"D x 35¼"H — 3 doors, 2 compartments
 42"W x 15"D x 35¼"H — 2 doors, 1 compartment
 36"W x 15"D x 35¼"H — 2 doors, 1 compartment

| | | | | | |
|-----------|-----|------|--------|------|-----|
| HNL3678FD | 153 | 31.8 | \$2144 | \$45 | N/A |
| HNL3672FD | 143 | 29.0 | \$2084 | \$35 | N/A |
| HNL3666FD | 134 | 26.7 | \$2065 | \$35 | N/A |
| HNL3660FD | 124 | 24.3 | \$1943 | \$35 | N/A |
| HNL3648FD | 104 | 19.6 | \$1649 | \$30 | N/A |
| HNL3642FD | 89 | 18.1 | \$1451 | \$30 | N/A |
| HNL3636FD | 79 | 15.3 | \$1280 | \$30 | N/A |

! Frosted/silver door units do not have a lock option.

NOTES:

- Convenient off-the-worksurface storage requires no additional floor space.
- 35¼"H stack-on storage models ship fully assembled.
- Fully enclosed back provides privacy; includes a 1¼", full-width pass-through for 3-prong electrical plugs; facilitates routing cords and reaching wall electrical outlets.
- Lower back panel can be attached with cord pass-through at bottom next to the worksurface or at top for close proximity to task light cord.
- Lower back panel can be removed to facilitate collaboration in teaming configurations.
- Valance hides task light.
- Vertical clearance for computer monitor is 20".
- Laminate vertical paper organizer (HLVPMI) sized to fit below storage compartments.
- Can be specified in seven widths (36", 42", 48", 60", 66", 72", and 78"W) and two heights, standard (35¼"H) or executive (48⅝"H).
- Available with laminate doors, frosted/silver doors, or sliding door.
- Doors are sized to overlap the top, end panels and light valance, to provide a clean design.
- Laminate and frosted/silver door units are equipped with self-closing, adjustable hinges.
- Laminate hinged door units are available with or without a lock.
- For tackboards, see page 57.
- For task lights, see page 111.
- For paper organizers, see page 108.

HOW TO SPECIFY

| | | | |
|---|---|--|--|
| <p>Select Model Number</p> <p>H N L 3 6 7 2 L D</p> | <p>Select Chassis Color</p> <p>See page 29</p> <p>H</p> | <p>Select Door Front Color</p> <p>See page 29</p> <p>H</p> | |
| <p>Select Model Number</p> <p>H N L 3 6 7 2 L L</p> | <p>Select Lock Finish</p> <p>See page 29</p> <p>P</p> | <p>Select Chassis Color</p> <p>See page 29</p> <p>H</p> | <p>Select Door Front Color</p> <p>See page 29</p> <p>H</p> |
| <p>Select Model Number</p> <p>H N L 3 6 7 2 F D</p> | <p>Select Chassis Color</p> <p>See page 29</p> <p>H</p> | | |

CONCINNITY™

Stack-on Storage

GSA SIN 33721

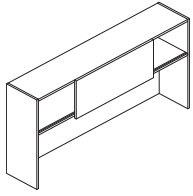

Icon Legend on page 19

**DESCRIPTION****Stack-on Storage, Sliding Door**

78"W x 15"D x 35¼"H
 72"W x 15"D x 35¼"H
 66"W x 15"D x 35¼"H
 60"W x 15"D x 35¼"H
 48"W x 15"D x 35¼"H

MODEL

HNL3678SD
HNL3672SD
HNL3666SD
HNL3660SD
HNL3648SD

SHIP WEIGHT

161
 151
 141
 131
 110

CUBE

31.8
 29.0
 26.7
 24.3
 19.6

L1 LIST

\$1387
\$1345
\$1240
\$1206
\$1140

L2 UPCHARGES

| CHASSIS | FRONTS |
|-------------|-------------|
| \$45 | \$20 |
| \$35 | \$20 |
| \$35 | \$20 |
| \$35 | \$20 |
| \$30 | \$20 |

NOTES: Sliding door units have one door per cabinet; standard with black lock, which is located on inside vertical support panel. Lock is core removable. Keyed alike cores must be ordered separately. For stack-on and wall mount storage with sliding door, specify model HF23B (Black) and the key number, see page 110. Sliding door availability limited to select sizes.

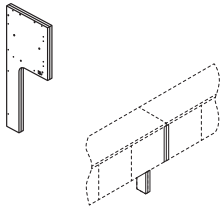
**Stack-on Space Saver End Panels**

¾"W x 14¼"D x 35¼"H

HNL3605SSEP

14

1.7

\$417**\$15****N/A**

NOTES: Two field installable end panels (1-right; 1-left) for use in ganging two stack-on storage units. Combining stack-on allows users to span longer worksurfaces, including 84" (2 - 42"W), 96" (2 - 48"W), 120" (2 - 60"W), and 144" (2 - 72"W). Narrow, space-saving panel size replaces the full 15"D end panels to expand worksurface space. The 4¼" right end panel is to replace the standard 15"D right end panel on one stack-on storage unit, the 4¼" left end panel is to replace the standard 15"D left end panel on a separate, adjacent stack-on storage unit that is in linear alignment with the first unit. Kit includes: (2) narrow end panel supports; European-style fasteners; dowels; joint connector bolts with sleeve nuts (for ganging stack-on storage units). Can be used to connect up to two stack-on storage units in a line (requires 1 kit). Can be specified in a woodgrain or solid laminate color only.

SPECIFYING EXAMPLE: HNL3605SSEP.H

NOTES:

- Convenient off-the-worksurface storage requires no additional floor space.
- 35¼"H stack-on storage models ship fully assembled.
- Fully enclosed back provides privacy; includes a 1¼", full-width pass-through for 3-prong electrical plugs; facilitates routing cords and reaching wall electrical outlets.
- Lower back panel can be attached with cord pass-through at bottom next to the worksurface or at top for close proximity to task light cord.
- Lower back panel can be removed to facilitate collaboration in teaming configurations.
- Valance hides task light.
- Vertical clearance for computer monitor is 20".
- Laminate vertical paper organizer (HLVPM1) sized to fit below storage compartments.
- Can be specified in seven widths (36", 42", 48", 60", 66", 72", and 78"W) and two heights, standard (35¼"H) or executive (48⅝"H).
- Available with laminate doors, frosted/silver doors, or sliding door.
- Doors are sized to overlap the top, end panels and light valance, to provide a clean design.
- Laminate and frosted/silver door units are equipped with self-closing, adjustable hinges.
- Laminate hinged door units are available with or without a lock.
- For tackboards, see page 57.
- For task lights, see page 111.
- For paper organizers, see page 108.

HOW TO SPECIFY**Select Model Number**

H N L 3 6 7 2 S D

Select Chassis Color

See page 29

H

Select Door Front Color

See page 29

H



CONCINNITY™ Stack-on Storage

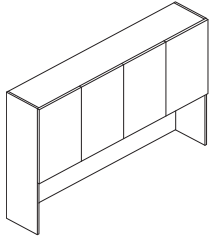

DESCRIPTION

Stack-on Storage, Laminate Doors
 78"W x 15"D x 48 5/8"H — 4 doors, 2 compartments
 72"W x 15"D x 48 5/8"H — 4 doors, 2 compartments
 66"W x 15"D x 48 5/8"H — 4 doors, 2 compartments
 60"W x 15"D x 48 5/8"H — 4 doors, 2 compartments
 48"W x 15"D x 48 5/8"H — 3 doors, 2 compartments
 42"W x 15"D x 48 5/8"H — 2 doors, 1 compartment
 36"W x 15"D x 48 5/8"H — 2 doors, 1 compartment

| MODEL | SHIP WEIGHT | CUBE | L1 LIST | L2 UPCHARGES | |
|------------------|-------------|------|---------------|--------------|-------------|
| | | | | CHASSIS | FRONTS |
| HNL4978LD | 264 | 31.3 | \$1952 | \$60 | \$20 |
| HNL4972LD | 243 | 29.1 | \$1796 | \$50 | \$20 |
| HNL4966LD | 229 | 26.8 | \$1698 | \$50 | \$20 |
| HNL4960LD | 212 | 24.5 | \$1579 | \$50 | \$20 |
| HNL4948LD | 175 | 26.4 | \$1506 | \$45 | \$20 |
| HNL4942LD | 149 | 23.2 | \$1320 | \$45 | \$20 |
| HNL4936LD | 145 | 20.3 | \$1278 | \$45 | \$20 |

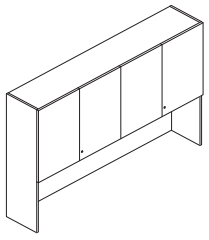

Stack-on Storage, Laminate Locking Doors
 78"W x 15"D x 48 5/8"H — 4 doors, 2 compartments
 72"W x 15"D x 48 5/8"H — 4 doors, 2 compartments
 66"W x 15"D x 48 5/8"H — 4 doors, 2 compartments
 60"W x 15"D x 48 5/8"H — 4 doors, 2 compartments
 48"W x 15"D x 48 5/8"H — 3 doors, 2 compartments
 42"W x 15"D x 48 5/8"H — 2 doors, 1 compartment
 36"W x 15"D x 48 5/8"H — 2 doors, 1 compartment

| | | | | | |
|------------------|-----|------|---------------|-------------|-------------|
| HNL4978LL | 264 | 31.3 | \$2041 | \$60 | \$20 |
| HNL4972LL | 243 | 29.1 | \$1885 | \$50 | \$20 |
| HNL4966LL | 229 | 26.8 | \$1787 | \$50 | \$20 |
| HNL4960LL | 212 | 24.5 | \$1668 | \$50 | \$20 |
| HNL4948LL | 175 | 26.4 | \$1572 | \$45 | \$20 |
| HNL4942LL | 149 | 23.2 | \$1365 | \$45 | \$20 |
| HNL4936LL | 145 | 20.3 | \$1322 | \$45 | \$20 |

! Lock available in Black (P) or Satin (SA) finish. Lock is core removable. Keyed alike cores must be ordered separately. For stack-on and wall mount storage with locking hinged doors, specify model HF27B (Black) or HF27S (Satin) and the key number, see page 110. Model HNL4948LL has one lock, which secures two of the three doors.

NOTES:

- Convenient off-the-worksurface storage requires no additional floor space.
- 48 5/8"H units have a fixed, intermittent shelf; storage space above and below the shelf is 12 5/8".
- Product applications are detailed on pages 51-52.
- Fully enclosed back provides privacy; includes a 1 1/4", full-width pass-through for 3-prong electrical plugs; facilitates routing cords and reaching wall electrical outlets.
- Lower back panel can be attached with cord pass-through at bottom next to the worksurface or at top for close proximity to task light cord.
- Lower back panel can be removed to facilitate collaboration in teaming configurations.
- Valance hides task light.
- Vertical clearance for computer monitor is 20".
- Laminate vertical paper organizer (HLVPMI) sized to fit below storage compartments.
- Can be specified in seven widths (36", 42", 48", 60", 66", 72", and 78"W) and two heights, standard (35 1/4"H) or executive (48 5/8"H).
- Available with laminate doors, frosted/silver doors, or sliding door.
- Doors are sized to overlap the top, end panels and light valance, to provide a clean design.
- Laminate and frosted/silver door units are equipped with self-closing, adjustable hinges.
- Laminate hinged door units are available with or without a lock.
- For tackboards, see page 57.
- For task lights, see page 111.
- For paper organizers, see page 108.

HOW TO SPECIFY

| | | | |
|--|--|---|---|
| <p>Select Model Number</p> <p>H N L 4 9 7 8 L D</p> | <p>Select Chassis Color</p> <p>See page 29</p> <p>H</p> | <p>Select Door Front Color</p> <p>See page 29</p> <p>H</p> | |
| <p>Select Model Number</p> <p>H N L 4 9 7 8 L L</p> | <p>Select Lock Finish</p> <p>See page 29</p> <p>P</p> | <p>Select Chassis Color</p> <p>See page 29</p> <p>H</p> | <p>Select Door Front Color</p> <p>See page 29</p> <p>H</p> |

CONCINNITY™

Stack-on Storage

GSA SIN 33721



Icon Legend on page 19

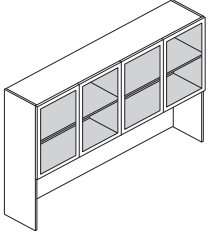

| DESCRIPTION | MODEL | SHIP WEIGHT | CUBE | L1 LIST | L2 UPCHARGES | |
|---|------------------|-------------|------|---------------|--------------|--------|
| | | | | | CHASSIS | FRONTS |
| Stack-on Storage, Frosted Doors with Silver Frame | | | | | | |
| 78"W x 15"D x 48 $\frac{5}{8}$ "H — 4 doors, 2 compartments | HNL4978FD | 225 | 31.3 | \$2995 | \$60 | N/A |
| 72"W x 15"D x 48 $\frac{5}{8}$ "H — 4 doors, 2 compartments | HNL4972FD | 207 | 29.1 | \$2839 | \$50 | N/A |
| 66"W x 15"D x 48 $\frac{5}{8}$ "H — 4 doors, 2 compartments | HNL4966FD | 196 | 26.8 | \$2741 | \$50 | N/A |
| 60"W x 15"D x 48 $\frac{5}{8}$ "H — 4 doors, 2 compartments | HNL4960FD | 182 | 24.5 | \$2619 | \$50 | N/A |
| 48"W x 15"D x 48 $\frac{5}{8}$ "H — 3 doors, 2 compartments | HNL4948FD | 152 | 26.4 | \$2290 | \$45 | N/A |
| 42"W x 15"D x 48 $\frac{5}{8}$ "H — 2 doors, 1 compartment | HNL4942FD | 128 | 23.2 | \$1846 | \$45 | N/A |
| 36"W x 15"D x 48 $\frac{5}{8}$ "H — 2 doors, 1 compartment | HNL4936FD | 114 | 20.3 | \$1802 | \$45 | N/A |

Frosted/silver door units do not have a lock option.

NOTES:

- Convenient off-the-worksurface storage requires no additional floor space.
- 48 $\frac{5}{8}$ "H units have a fixed, intermittent shelf; storage space above and below the shelf is 12 $\frac{5}{8}$ ".
- Product applications are detailed on pages 51-52.
- Fully enclosed back provides privacy; includes a 1 $\frac{1}{4}$ ", full-width pass-through for 3-prong electrical plugs; facilitates routing cords and reaching wall electrical outlets.
- Lower back panel can be attached with cord pass-through at bottom next to the worksurface or at top for close proximity to task light cord.
- Lower back panel can be removed to facilitate collaboration in teaming configurations.
- Valance hides task light.
- Vertical clearance for computer monitor is 20".
- Laminate vertical paper organizer (HLVPM1) sized to fit below storage compartments.
- Can be specified in seven widths (36", 42", 48", 60", 66", 72", and 78"W) and two heights, standard (35 $\frac{1}{4}$ "H) or executive (48 $\frac{5}{8}$ "H).
- Available with laminate doors, frosted/silver doors, or sliding door.
- Doors are sized to overlap the top, end panels and light valance, to provide a clean design.
- Laminate and frosted/silver door units are equipped with self-closing, adjustable hinges.
- Laminate hinged door units are available with or without a lock.
- For tackboards, see page 57.
- For task lights, see page 111.
- For paper organizers, see page 108.

HOW TO SPECIFY

Select
Model Number

Select
Chassis Color

See page 29

H N L 4 9 7 8 F D . H



CONCINNITY™ Stack-on Storage

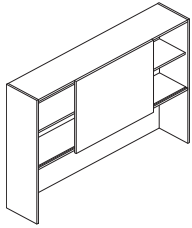

| DESCRIPTION | MODEL | COM | SHIP WEIGHT | CUBE | L1 LIST | L2 UPCHARGES | |
|---|------------------|-----|-------------|------|---------------|--------------|-------------|
| | | | | | | CHASSIS | FRONTS |
| Stack-on Storage, Sliding Door | | | | | | | |
| 78"W x 15"D x 48 ⁵ / ₈ "H | HNL4978SD | | 236 | 31.3 | \$1981 | \$60 | \$20 |
| 72"W x 15"D x 48 ⁵ / ₈ "H | HNL4972SD | | 221 | 29.1 | \$1874 | \$50 | \$20 |
| 66"W x 15"D x 48 ⁵ / ₈ "H | HNL4966SD | | 207 | 26.8 | \$1831 | \$50 | \$20 |
| 60"W x 15"D x 48 ⁵ / ₈ "H | HNL4960SD | | 192 | 24.5 | \$1614 | \$50 | \$20 |
| 48"W x 15"D x 48 ⁵ / ₈ "H | HNL4948SD | | 162 | 26.4 | \$1537 | \$45 | \$20 |

NOTES: Sliding door units have one door per cabinet; standard with black lock, which is located on inside vertical support panel. Lock is core removable. Keyed alike cores must be ordered separately. For stack-on and wall mount storage with sliding door, specify model HF23B (Black) and the key number, see page 110. Sliding door availability limited to select sizes.

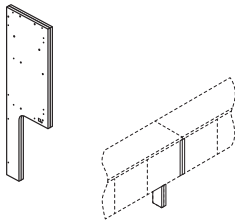

| DESCRIPTION | MODEL | COM | SHIP WEIGHT | CUBE | L1 LIST | L2 UPCHARGES |
|---|--------------------|-----|-------------|------|--------------|------------------------|
| Stack-on Space Saver End Panels 3/4"W x 14 1/4"D x 48 5/8"H | HNL4905SSEP | | 23 | 2.2 | \$561 | \$15 N/A |

NOTES: Two field installable end panels (1-right; 1-left) for use in ganging two stack-on storage units. Combining stack-on allows users to span longer worksurfaces, including 84" (2 - 42"W), 96" (2 - 48"W), 120" (2 - 60"W), and 144" (2 - 72"W). Narrow, space-saving panel size replaces the full 15"D end panels to expand worksurface space. The 4 1/4" right end panel is to replace the standard 15"D right end panel on one stack-on storage unit, the 4 1/4" left end panel is to replace the standard 15"D left end panel on a separate, adjacent stack-on storage unit that is in linear alignment with the first unit. Kit includes: (2) narrow end panel supports; European-style fasteners; dowels; joint connector bolts with sleeve nuts (for ganging stack-on storage units). Can be used to connect up to two stack-on storage units in a line (requires 1 kit). Can be specified in a woodgrain or solid laminate color only.

SPECIFYING EXAMPLE: HNL4905SSEP.H

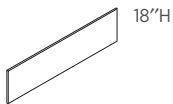

| DESCRIPTION | MODEL | COM | SHIP WEIGHT | CUBE | L1 LIST | L2 UPCHARGES |
|---|---------------|-----|-------------|------|--------------|-----------------------|
| Tackboards for use with Stack-on Storage | | | | | | |
| 75"W - for 78"W | H90057 | 3.0 | 13 | 3.2 | \$337 | N/A N/A |
| 68 3/4"W - for 72"W | H90056 | 2.0 | 12 | 2.7 | \$320 | N/A N/A |
| 62 3/4"W - for 66"W | H90055 | 2.0 | 11 | 2.5 | \$304 | N/A N/A |
| 56 3/4"W - for 60"W | H90054 | 2.0 | 10 | 2.2 | \$268 | N/A N/A |
| 44 3/4"W - for 48"W | H90053 | 2.0 | 8 | 1.8 | \$257 | N/A N/A |
| 39"W - for 42"W | H90052 | 2.0 | 7 | 1.6 | \$237 | N/A N/A |
| 33"W - for 36"W | H90051 | 1.0 | 6 | 1.4 | \$208 | N/A N/A |
| 26 3/4"W | H90050 | 1.0 | 5 | 1.2 | \$208 | N/A N/A |

NOTES: Specify fabric, see pages 25-26. Upcharges may apply to premium fabric grades.

Disperse (DISP) fabric not available on sizes wider than 60". Analog (ANLG) and Exchange (EXG) not available on sizes wider than 72".

SPECIFYING EXAMPLE: H90057.APN15

NOTES:

- Convenient off-the-worksurface storage requires no additional floor space.
- 48⁵/₈"H units have a fixed, intermittent shelf; storage space above and below the shelf is 12⁵/₈".
- Fully enclosed back provides privacy; includes a 1/4", full-width pass-through for 3-prong electrical plugs; facilitates routing cords and reaching wall electrical outlets.
- Lower back panel can be attached with cord pass-through at bottom next to the worksurface or at top for close proximity to task light cord.
- Lower back panel can be removed to facilitate collaboration in teaming configurations.
- Valance hides task light.
- Vertical clearance for computer monitor is 20".
- Laminate vertical paper organizer (HLVPM1) sized to fit below storage compartments.
- Can be specified in seven widths (36", 42", 48", 60", 66", 72", and 78"W) and two heights, standard (35 1/4"H) or executive (48 5/8"H).
- Available with laminate doors, frosted/silver doors, or sliding door.
- Doors are sized to overlap the top, end panels and light valance, to provide a clean design.
- Laminate and frosted/silver door units are equipped with self-closing, adjustable hinges.
- Laminate hinged door units are available with or without a lock.
- For tackboards, see above.
- For task lights, see page 111.
- For paper organizers, see page 108.

HOW TO SPECIFY

Select
Model Number

H N L 4 9 7 8 S D

Select
Chassis Color

See page 29

H

Select
Door Front Color

See page 29

H

CONCINNITY™ WALL MOUNT STORAGE APPLICATIONS

- Installation (review carefully):
 - **Attachment requires individual cabinets be secured by a minimum of two (2) wall mounting locations/studs.**
 - **Designed for interior and perimeter walls that are constructed with wood or metal studs.**
 - **Attaches to wall with horizontally mounted, interlocking brackets.**
 - **The HON Company is not responsible for any liabilities resulting from wall mounted storage cabinets that are not properly installed.**
- Laminate, laminate locking, and frosted/silver door units can be specified in eight widths (30", 36", 42", 48", 60", 66", 72", and 78"W) and two heights, standard (15"H) or executive (29½"H).
- Sliding door units can be specified in five widths (48", 60", 66", 72", and 78"W) and two heights, standard (15"H) or executive (29½"H).
- Product placement can be aligned to match the height of 64¾"H or 78½"H storage- and wardrobe-type cabinets.
- Available with laminate doors, frosted/silver doors, or sliding door.
 - Door design overlaps end panels so that when multiple units are placed side-by-side they appear as one continuous unit.
 - Laminate and frosted/silver door units are equipped with self-closing, adjustable hinges.
 - Laminate hinged door units are available with or without a lock.
 - Lock available in Black (P) or Satin (SA).
 - Lock is core removable; keyed alike cores must be ordered separately — for overhead storage with hinged doors specify model HF27B or HF27S and the key number.
 - Frosted/silver hinged door units do not have a lock option.
 - Sliding door units have one door per cabinet; standard with black lock, which is located on inside vertical support panel. Lock is core removable; keyed alike cores must be ordered separately — for overhead storage with a sliding door specify model HF23B (Black) and the key number.
 - Laminate and frosted/silver door cabinets in 30", 36", and 42"W have two doors; 48"W has three doors; 60", 66", 72", and 78"W have four doors.
- Inside storage dimensions of 15"H cabinets:
 - 30"W = one compartment, sized 28⅜"W x 13⅜"D x 12¾"H
 - 36"W = one compartment, sized 34⅜"W x 13⅜"D x 12¾"H
 - 42"W = one compartment, sized 40⅜"W x 13⅜"D x 12¾"H
 - 48"W = two compartments, one sized 30⅝"W x 13⅜"D x 12¾"H; one sized 14⅝"W x 13⅜"D x 12¾"H
 - 60"W = two compartments, each 28⅝"W x 13⅜"D x 12¾"H
 - 66"W = two compartments, each 31⅝"W x 13⅜"D x 12¾"H
 - 72"W = two compartments, each 34⅝"W x 13⅜"D x 12¾"H
 - 78"W = two compartments, each 37⅝"W x 13⅜"D x 12¾"H
- 28½"H units have a fixed, intermittent shelf; storage space above and below the shelf is 12⅝".
- Wall mounted storage cabinets are not designed for attachment to O-leg models HLSL65OS or HLSL50OS.
- Horizontal interlocking rails are included; due to varying types of walls, installers are responsible for selecting and supplying the appropriate fasteners.
- Ship fully assembled.

CONCINNITY™ WALL MOUNT STORAGE APPLICATIONS

OPTIONS INCLUDE:

- Door/Storage Options:

| Door(s) | Standard-Height | Executive-Height |
|------------------|-----------------|------------------|
| Laminate | • | • |
| Laminate Locking | • | • |
| Frosted/Silver | • | • |
| Sliding | 48"-78"W only | 48"-78"W only |

- Paper organizers for stack-on and wall mounted storage cabinets (see compatibility information on page 109).
- Fabric-Covered Tackboards:
 - Tackboards mount directly to wall using the fasteners or hook-and-loop tape provided.
 - For a list of standard fabrics, see pages 25-26. For a complete list of fabrics, please go to hon.com/fabricsandfinishes.
 - See compatibility cross reference below.
 - NOTE: Tackboard widths differ slightly from the wall mounted storage cabinet widths. For applications where multiple wall mounted storage units are placed side-by-side, the preferred tackboard solution may be to utilize a larger tackboard size.
For example, H90057 = 75"W; H90056 = 68³/₄"W; H90055 = 62³/₄"W; H90054 = 56³/₄"W.
- Markerboards:
 - HL1530SOMB: 29¹/₂"W x 12¹/₂"H panel attaches to 60" and 66"W stack-on and wall mounted storage with sliding door models with double-sided tape.
 - HL1536SOMB: 35¹/₂"W x 12¹/₂"H panel attaches to 72" and 78"W stack-on and wall mounted storage with sliding door models with double-sided tape.
- Task Lights:
 - Attach to underside of stack-on and wall mount storage cabinets.
 - Fluorescent or LED options.
 - Compatibility: Tackboard and task light solutions, by model, for each wall mounted storage cabinet size:

| Wall Mounted Storage | Tackboard | Fluorescent Task Light | LED Task Light |
|----------------------|--|------------------------|--------------------|
| 78"W | H90057 (75"W) or qty 2 of H90052 (39"W ea.) | HH870960, HH870960CH | HLED31A, HLED31AUO |
| 72"W | H90056 (71 ¹ / ₂ "W) | HH870960, HH870960CH | HLED31A, HLED31AUO |
| 66"W | H90055 (65 ¹⁵ / ₁₆ "W) | HH870960, HH870960CH | HLED31A, HLED17AUO |
| 60"W | H90054 (59 ¹⁵ / ₁₆ "W) | HH870960, HH870960CH | HLED31A, HLED17AUO |
| 48"W | H90053 (44 ³ / ₄ "W) | HH870942, HH870942CH | HLED31AS |
| 42"W | H90052 (39"W) | HH870942, HH870942CH | HLED31AS |
| 36"W | H90051 (33"W) | HH870930, HH870930CH | HLED17AS |
| 30"W | H90050 (26 ³ / ₄ "W) | HH870930, HH870930CH | HLED17AS |

CONCINNITY™

Wall Mount Storage

GSA SIN 33721

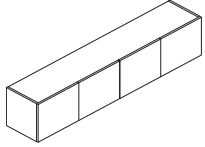

Icon Legend on page 19

**DESCRIPTION****Wall Mount Storage, Laminate Doors**

78"W x 15"D x 15"H — 4 doors, 2 compartments
 72"W x 15"D x 15"H — 4 doors, 2 compartments
 66"W x 15"D x 15"H — 4 doors, 2 compartments
 60"W x 15"D x 15"H — 4 doors, 2 compartments
 48"W x 15"D x 15"H — 3 doors, 2 compartments
 42"W x 15"D x 15"H — 2 doors, 1 compartment
 36"W x 15"D x 15"H — 2 doors, 1 compartment
 30"W x 15"D x 15"H — 2 doors, 1 compartment

MODEL**SHIP WEIGHT****CUBE****L1 LIST****L2 UPCHARGES**
CHASSIS **FRONTS**

| | | | | | |
|------------------|-----|------|---------------|-------------|-------------|
| HNL1578LD | 126 | 17.1 | \$1362 | \$35 | \$20 |
| HNL1572LD | 118 | 15.9 | \$1265 | \$25 | \$20 |
| HNL1566LD | 109 | 14.6 | \$1206 | \$25 | \$20 |
| HNL1560LD | 100 | 13.3 | \$1083 | \$25 | \$20 |
| HNL1548LD | 83 | 10.9 | \$977 | \$20 | \$20 |
| HNL1542LD | 68 | 9.7 | \$923 | \$20 | \$10 |
| HNL1536LD | 60 | 8.4 | \$842 | \$20 | \$10 |
| HNL1530LD | 51 | 7.2 | \$777 | \$20 | \$10 |

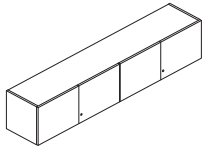
**Wall Mount Storage, Laminate Locking Doors**

78"W x 15"D x 15"H — 4 doors, 2 compartments
 72"W x 15"D x 15"H — 4 doors, 2 compartments
 66"W x 15"D x 15"H — 4 doors, 2 compartments
 60"W x 15"D x 15"H — 4 doors, 2 compartments
 48"W x 15"D x 15"H — 3 doors, 2 compartments
 42"W x 15"D x 15"H — 2 doors, 1 compartment
 36"W x 15"D x 15"H — 2 doors, 1 compartment
 30"W x 15"D x 15"H — 2 doors, 1 compartment

| | | | | | |
|------------------|-----|------|---------------|-------------|-------------|
| HNL1578LL | 126 | 17.1 | \$1451 | \$35 | \$20 |
| HNL1572LL | 118 | 15.9 | \$1354 | \$25 | \$20 |
| HNL1566LL | 109 | 14.6 | \$1295 | \$25 | \$20 |
| HNL1560LL | 100 | 13.3 | \$1172 | \$25 | \$20 |
| HNL1548LL | 83 | 10.9 | \$1044 | \$20 | \$20 |
| HNL1542LL | 68 | 9.7 | \$967 | \$20 | \$10 |
| HNL1536LL | 60 | 8.4 | \$887 | \$20 | \$10 |
| HNL1530LL | 51 | 7.2 | \$822 | \$20 | \$10 |

! Lock available in Black (P) or Satin (SA) finish. Lock is core removable. Keyed alike cores must be ordered separately. For stack-on and wall mount storage with locking hinged doors, specify model HF27B (Black) or HF27S (Satin) and the key number, see page 110. Model HNL1548LL has one lock, which secures two of the three doors.

NOTES:

- Convenient off-the-worksurface storage requires no additional floor space.
- Available with laminate doors, frosted/silver doors, or sliding door.
- Doors are sized to overlap the top, end panels and light valance, to provide a clean design.
- Laminate and frosted/silver door units are equipped with self-closing, adjustable hinges.
- Laminate hinged door units are available with or without a lock.
- For tackboards, see page 63.
- For task lights, see page 111.
- For paper organizers, see page 108.
- **IMPORTANT: See installation guidelines at top of page 58.**

HOW TO SPECIFY**Select Model Number**

H N L 1 5 7 8 L D

Select Chassis Color

See page 29

H

Select Door Front Color

See page 29

H

Select Model Number

H N L 1 5 7 8 L L

Select Lock Finish

See page 29

P

Select Chassis Color

See page 29

H

Select Door Front Color

See page 29

H



CONCINNITY™ Wall Mount Storage

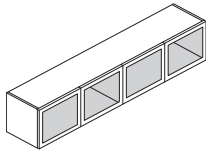

DESCRIPTION

Wall Mount Storage, Frosted Doors with Silver Frame

- 78"W x 15"D x 15"H — 4 doors, 2 compartments
- 72"W x 15"D x 15"H — 4 doors, 2 compartments
- 66"W x 15"D x 15"H — 4 doors, 2 compartments
- 60"W x 15"D x 15"H — 4 doors, 2 compartments
- 48"W x 15"D x 15"H — 3 doors, 2 compartments
- 42"W x 15"D x 15"H — 2 doors, 1 compartment
- 36"W x 15"D x 15"H — 2 doors, 1 compartment
- 30"W x 15"D x 15"H — 2 doors, 1 compartment

MODEL

SHIP WEIGHT

CUBE

L1 LIST

**L2 UPCHARGES
CHASSIS FRONTS**

| | | | | | |
|------------------|-----|------|---------------|-------------|------------|
| HNL1578FD | 106 | 17.1 | \$2060 | \$35 | N/A |
| HNL1572FD | 99 | 15.9 | \$1961 | \$25 | N/A |
| HNL1566FD | 92 | 14.6 | \$1901 | \$25 | N/A |
| HNL1560FD | 85 | 13.3 | \$1777 | \$25 | N/A |
| HNL1548FD | 71 | 10.9 | \$1498 | \$20 | N/A |
| HNL1542FD | 57 | 9.7 | \$1274 | \$20 | N/A |
| HNL1536FD | 50 | 8.4 | \$1193 | \$20 | N/A |
| HNL1530FD | 43 | 7.2 | \$1127 | \$20 | N/A |

❗ Frosted door models do not have a lock option.

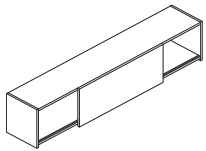

Wall Mount Storage, Sliding Door

- 78"W x 15"D x 15"H
- 72"W x 15"D x 15"H
- 66"W x 15"D x 15"H
- 60"W x 15"D x 15"H
- 48"W x 15"D x 15"H

| | | | | | |
|------------------|-----|------|---------------|-------------|-------------|
| HNL1578SD | 114 | 17.1 | \$1325 | \$35 | \$20 |
| HNL1572SD | 107 | 15.9 | \$1217 | \$25 | \$20 |
| HNL1566SD | 99 | 14.6 | \$1135 | \$25 | \$20 |
| HNL1560SD | 91 | 13.3 | \$1031 | \$25 | \$20 |
| HNL1548SD | 76 | 10.9 | \$965 | \$20 | \$20 |

NOTES: One door per unit. Standard with black lock, which is located on the inside vertical support panel. Lock is core removable. Keyed alike cores must be ordered separately. For stack-on and wall mount storage with sliding door, specify model HF23B (Black) and the key number, see page 110.

NOTES:

- Convenient off-the-worksurface storage requires no additional floor space.
- Available with laminate doors, frosted/silver doors, or sliding door.
- Doors are sized to overlap the top, end panels and light valance, to provide a clean design.
- Laminate and frosted/silver door units are equipped with self-closing, adjustable hinges.
- Laminate hinged door units are available with or without a lock.
- For tackboards, see page 63.
- For task lights, see page 111.
- For paper organizers, see page 108.
- **IMPORTANT: See installation guidelines at top of page 58.**

HOW TO SPECIFY

| | | |
|--|--|---|
| <p>Select Model Number</p> <div style="border: 1px solid black; display: flex; justify-content: space-between; align-items: center; padding: 2px;"> HNL1578FD </div> | <p>Select Chassis Color</p> <p>See page 29</p> <div style="border: 1px solid black; display: flex; justify-content: space-between; align-items: center; padding: 2px;"> H </div> | |
| <p>Select Model Number</p> <div style="border: 1px solid black; display: flex; justify-content: space-between; align-items: center; padding: 2px;"> HNL1578SD </div> | <p>Select Chassis Color</p> <p>See page 29</p> <div style="border: 1px solid black; display: flex; justify-content: space-between; align-items: center; padding: 2px;"> H </div> | <p>Select Door Front Color</p> <p>See page 29</p> <div style="border: 1px solid black; display: flex; justify-content: space-between; align-items: center; padding: 2px;"> H </div> |

CONCINNITY™ Wall Mount Storage

GSA SIN 33721



Icon Legend on page 19

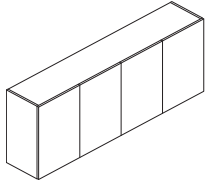

DESCRIPTION

Wall Mount Storage, Laminate Doors

- 78"W x 15"D x 28½"H — 4 doors, 2 compartments
- 72"W x 15"D x 28½"H — 4 doors, 2 compartments
- 66"W x 15"D x 28½"H — 4 doors, 2 compartments
- 60"W x 15"D x 28½"H — 4 doors, 2 compartments
- 48"W x 15"D x 28½"H — 3 doors, 2 compartments
- 42"W x 15"D x 28½"H — 2 doors, 1 compartment
- 36"W x 15"D x 28½"H — 2 doors, 1 compartment
- 30"W x 15"D x 28½"H — 2 doors, 1 compartment

MODEL

SHIP WEIGHT

CUBE

L1 LIST

**L2 UPCHARGES
CHASSIS FRONTS**

| | | | | | |
|------------------|-----|------|---------------|-------------|-------------|
| HNL2978LD | 213 | 30.8 | \$1651 | \$50 | \$40 |
| HNL2972LD | 199 | 28.6 | \$1566 | \$40 | \$40 |
| HNL2966LD | 185 | 26.4 | \$1517 | \$40 | \$40 |
| HNL2960LD | 170 | 24.1 | \$1409 | \$40 | \$40 |
| HNL2948LD | 142 | 19.7 | \$1284 | \$35 | \$30 |
| HNL2942LD | 116 | 17.4 | \$1054 | \$35 | \$20 |
| HNL2936LD | 101 | 15.2 | \$1005 | \$35 | \$20 |
| HNL2930LD | 87 | 12.9 | \$897 | \$35 | \$20 |

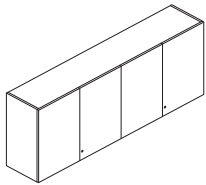

Wall Mount Storage, Laminate Locking Doors

- 78"W x 15"D x 28½"H — 4 doors, 2 compartments
- 72"W x 15"D x 28½"H — 4 doors, 2 compartments
- 66"W x 15"D x 28½"H — 4 doors, 2 compartments
- 60"W x 15"D x 28½"H — 4 doors, 2 compartments
- 48"W x 15"D x 28½"H — 3 doors, 2 compartments
- 42"W x 15"D x 28½"H — 2 doors, 1 compartment
- 36"W x 15"D x 28½"H — 2 doors, 1 compartment
- 30"W x 15"D x 28½"H — 2 doors, 1 compartment

| | | | | | |
|------------------|-----|------|---------------|-------------|-------------|
| HNL2978LL | 213 | 30.8 | \$1740 | \$50 | \$40 |
| HNL2972LL | 199 | 28.6 | \$1655 | \$40 | \$40 |
| HNL2966LL | 185 | 26.4 | \$1606 | \$40 | \$40 |
| HNL2960LL | 170 | 24.1 | \$1498 | \$40 | \$40 |
| HNL2948LL | 142 | 19.7 | \$1351 | \$35 | \$30 |
| HNL2942LL | 116 | 17.4 | \$1099 | \$35 | \$20 |
| HNL2936LL | 101 | 15.2 | \$1050 | \$35 | \$20 |
| HNL2930LL | 87 | 12.9 | \$942 | \$35 | \$20 |

! Lock available in Black (P) or Satin (SA) finish. Lock is core removable. Keyed alike cores must be ordered separately. For stack-on and wall mount storage with locking hinged doors, specify model HF27B (Black) or HF27S (Satin) and the key number, see page 110. Model HNL2948LL has one lock, which secures two of the three doors.

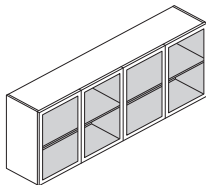

Wall Mount Storage, Frosted Doors with Silver Frame

- 78"W x 15"D x 28½"H — 4 doors, 2 compartments
- 72"W x 15"D x 28½"H — 4 doors, 2 compartments
- 66"W x 15"D x 28½"H — 4 doors, 2 compartments
- 60"W x 15"D x 28½"H — 4 doors, 2 compartments
- 48"W x 15"D x 28½"H — 3 doors, 2 compartments
- 42"W x 15"D x 28½"H — 2 doors, 1 compartment
- 36"W x 15"D x 28½"H — 2 doors, 1 compartment
- 30"W x 15"D x 28½"H — 2 doors, 1 compartment

| | | | | | |
|------------------|-----|------|---------------|-------------|------------|
| HNL2978FD | 174 | 30.8 | \$2693 | \$50 | N/A |
| HNL2972FD | 163 | 28.6 | \$2607 | \$40 | N/A |
| HNL2966FD | 152 | 26.4 | \$2558 | \$40 | N/A |
| HNL2960FD | 140 | 24.1 | \$2449 | \$40 | N/A |
| HNL2948FD | 118 | 19.7 | \$2066 | \$35 | N/A |
| HNL2942FD | 94 | 17.4 | \$1578 | \$35 | N/A |
| HNL2936FD | 83 | 15.2 | \$1528 | \$35 | N/A |
| HNL2930FD | 72 | 12.9 | \$1418 | \$35 | N/A |

! Frosted door models do not have a lock option.

NOTES:

- Convenient off-the-worksurface storage requires no additional floor space.
- Available with laminate doors, frosted/silver doors, or sliding door.
- Doors are sized to overlap the top, end panels and light valance, to provide a clean design.
- Laminate and frosted/silver door units are equipped with self-closing, adjustable hinges.
- Laminate hinged door units are available with or without a lock.
- 28½"H units have a fixed, intermittent shelf; storage space above and below the shelf is 12½".
- For tackboards, see page 63.
- For task lights, see page 111.
- For paper organizers, see page 108.
- **IMPORTANT: See installation guidelines at top of page 58.**

HOW TO SPECIFY

| | | | |
|--|--|---|---|
| <p>Select Model Number</p> <p>H N L 2 9 7 8 L D</p> | <p>Select Chassis Color</p> <p>See page 29</p> <p>H</p> | <p>Select Door Front Color</p> <p>See page 29</p> <p>H</p> | |
| <p>Select Model Number</p> <p>H N L 2 9 7 8 L L</p> | <p>Select Lock Finish</p> <p>See page 29</p> <p>P</p> | <p>Select Chassis Color</p> <p>See page 29</p> <p>H</p> | <p>Select Door Front Color</p> <p>See page 29</p> <p>H</p> |
| <p>Select Model Number</p> <p>H N L 2 9 7 8 F D</p> | <p>Select Chassis Color</p> <p>See page 29</p> <p>H</p> | | |



CONCINNITY™ Wall Mount Storage

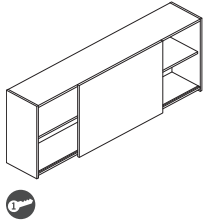

| DESCRIPTION | MODEL | COM | SHIP WEIGHT | CUBE | L1 LIST | L2 UPCHARGES | |
|---|------------------|-----|-------------|------|---------------|--------------|-------------|
| | | | | | | CHASSIS | FRONTS |
| Wall Mount Storage, Sliding Door | | | | | | | |
| 78"W x 15"D x 28½"H | HNL2978SD | | 189 | 30.8 | \$1717 | \$50 | \$40 |
| 72"W x 15"D x 28½"H | HNL2972SD | | 177 | 28.6 | \$1638 | \$40 | \$40 |
| 66"W x 15"D x 28½"H | HNL2966SD | | 165 | 26.4 | \$1600 | \$40 | \$40 |
| 60"W x 15"D x 28½"H | HNL2960SD | | 153 | 24.1 | \$1497 | \$40 | \$40 |
| 48"W x 15"D x 28½"H | HNL2948SD | | 129 | 19.7 | \$1314 | \$35 | \$30 |

NOTES: One door per unit. Standard with black lock, which is located on the inside vertical support panel. Lock is core removable. Keyed alike cores must be ordered separately. For stack-on and wall mount storage with sliding door, specify model HF23B (Black) and the key number, see page 110.

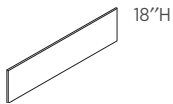

| Tackboards for use with Wall Mount Storage | | | | | | | |
|--|---------------|-----|----|-----|--------------|-----|-----|
| 75"W - for 78"W | H90057 | 3.0 | 13 | 3.2 | \$337 | N/A | N/A |
| 68¾"W - for 72"W | H90056 | 2.0 | 12 | 2.7 | \$320 | N/A | N/A |
| 62¾"W - for 66"W | H90055 | 2.0 | 11 | 2.5 | \$304 | N/A | N/A |
| 56¾"W - for 60"W | H90054 | 2.0 | 10 | 2.2 | \$268 | N/A | N/A |
| 44¾"W - for 48"W | H90053 | 2.0 | 8 | 1.8 | \$257 | N/A | N/A |
| 39"W - for 42"W | H90052 | 2.0 | 7 | 1.6 | \$237 | N/A | N/A |
| 33"W - for 36"W | H90051 | 1.0 | 6 | 1.4 | \$208 | N/A | N/A |
| 26¾"W | H90050 | 1.0 | 5 | 1.2 | \$208 | N/A | N/A |

NOTES: Specify fabric, see pages 25-26. Upcharges may apply to premium fabric grades. Tackboard widths differ slightly from the wall mounted storage cabinet widths. For applications where multiple wall mounted storage units are placed side-by-side, the preferred tackboard solution may be to utilize a larger tackboard size. For example, H90057 = 75"W; H90056 = 68¾"W; H90055 = 62¾"W; H90054 = 56¾"W.

ⓘ Disperse (DISP) fabric not available on sizes wider than 60". Analog (ANLG) and Exchange (EXG) not available on sizes wider than 72".
SPECIFYING EXAMPLE: H90057.APN15

NOTES:

- Convenient off-the-worksurface storage requires no additional floor space.
- Valance hides task light.
- Available with laminate doors, frosted/silver doors, or sliding door.
- Doors are sized to overlap the top, end panels and light valance, to provide a clean design.
- Laminate and frosted/silver door units are equipped with self-closing, adjustable hinges.
- Laminate hinged door units are available with or without a lock.
- 28½"H units have a fixed, intermittent shelf; storage space above and below the shelf is 12⅝".
- For tackboards, see above.
- For task lights, see page 111.
- For paper organizers, see page 108.
- **IMPORTANT: See installation guidelines at top of page 58.**

HOW TO SPECIFY

| | | |
|--|--|---|
| <p>Select Model Number</p> <p>H N L 2 9 7 8 S D</p> | <p>Select Chassis Color</p> <p>See page 29</p> <p>H</p> | <p>Select Door Front Color</p> <p>See page 29</p> <p>H</p> |
|--|--|---|

CONCINNITY™ Bookcase Hutches

GSA SIN 33721

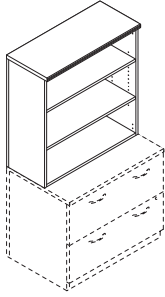

Icon Legend on page 19

**DESCRIPTION****Bookcase Hutch, No Doors/Open**

36"W x 14 1/4"D x 35 1/4"H (shown)
30"W x 14 1/4"D x 35 1/4"H

36"W x 14 1/4"D x 48 5/8"H
30"W x 14 1/4"D x 48 5/8"H

MODEL**SHIP WEIGHT****CUBE****L1 LIST****L2 UPCHARGES**
CHASSIS FRONTS

HNL3636BHxD
HNL3630BHxD

213
199

15.3
12.5

\$640
\$626

\$15
\$15

N/A
N/A

HNL4936BHxD
HNL4930BHxD

213
199

125.0
109.0

\$808
\$755

\$25
\$25

N/A
N/A

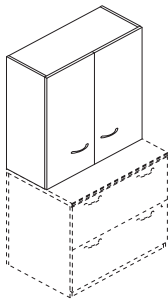
**Bookcase Hutch, Laminate Doors**

36"W x 15"D x 35 1/4"H (shown)
30"W x 15"D x 35 1/4"H

36"W x 15"D x 48 5/8"H
30"W x 15"D x 48 5/8"H

HNL3636BHLD
HNL3630BHLD

213
199

15.3
12.5

\$827
\$775

\$15
\$15

\$20
\$20

HNL4936BHLD
HNL4930BHLD

213
199

165.0
142.0

\$991
\$929

\$25
\$25

\$30
\$30

NOTES:

- Designed for use on worksurfaces, or on 30" or 36" W x 29 1/2" H lateral file or storage cabinet with doors.
- Two widths, 30" and 36"; two heights, 35 1/4" and 48 5/8".
- The 35 1/4" H unit has three shelves, two are adjustable in 1/4" increments with a total range of 17 1/2"; bottom shelf is fixed.
- The 48 5/8" H unit has four shelves, three are adjustable in 1/4" increments with a total range of 25"; bottom shelf is fixed.
- Available with laminate doors or frosted/silver doors or no doors (open).
- Door units equipped with self-closing, adjustable hinges.
- Laminate doors have decorative handles.
- Frosted door units have push/touch latch release.
- Doors are non-locking.
- To align with the top of the 35 1/4" bookcase hutch, use 64 3/4" H floor-standing storage models; to align with the top of the 48 5/8" H bookcase hutch, use 78 3/8" H models.
- Ship fully assembled.

HOW TO SPECIFY**Select Model Number**

H N L 3 6 3 6 B H X D .

Select Laminate Color

See page 29

H

Select Model Number

H N L 3 6 3 6 B H L D .

Select Handle

- A Cylinder - Satin
- B Cylinder - Black
- C Canopy - Satin
- D Canopy - Black
- E Loop - Satin
- F Loop - Black

E .

Select Chassis Color

See page 29

H .

Select Door Front Color

See page 29

H



CONCINNITY™ Bookcase Hutches

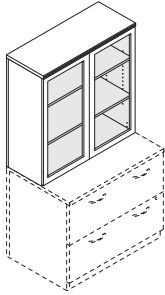

| DESCRIPTION | MODEL | SHIP WEIGHT | CUBE | L1 LIST | L2 UPCHARGES | |
|---|--------------------|-------------|-------|---------------|--------------|------------|
| | | | | | CHASSIS | FRONTS |
| Bookcase Hutch, Frosted Doors with Silver Frame 36"W x 15"D x 35¼"H (shown) | HNL3636BHFD | 199 | 15.3 | \$1518 | \$15 | N/A |
| 36"W x 15"D x 48⅝"H | HNL4936BHFD | 213 | 134.0 | \$1854 | \$25 | N/A |

NOTES:

- Designed for use on worksurfaces, or on 30" or 36"W x 29½"H lateral file or storage cabinet with doors.
- Two widths, 30" and 36"; two heights, 35¼" and 48⅝".
- The 35¼"H unit has three shelves, two are adjustable in 1¼" increments with a total range of 17½"; bottom shelf is fixed.
- The 48⅝"H unit has four shelves, three are adjustable in 1¼" increments with a total range of 25"; bottom shelf is fixed.
- Available with laminate doors or frosted/silver doors or no doors (open).
- Door units equipped with self-closing, adjustable hinges.
- Laminate doors have decorative handles.
- Frosted door units have push/touch latch release.
- Doors are non-locking.
- To align with the top of the 35¼"H bookcase hutch, use 64¾"H floor-standing storage models; to align with the top of the 48⅝"H bookcase hutch, use 78⅝"H models.
- Ship fully assembled.

HOW TO SPECIFY

Select
Model Number

H N L 3 6 3 6 B H F D .

Select
Chassis Color

See page 29

H

CONCINNITY™ Reception Stations

GSA SIN 33721



Icon Legend on page 19

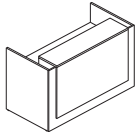

| DESCRIPTION | MODEL | SHIP WEIGHT | CUBE | L1 LIST | L2 UPCHARGES | | ACCENT PANEL |
|-------------|-------|-------------|------|---------|--------------|---------|--------------|
| | | | | | WORKSURFACE | CHASSIS | |

| | | | | | | | |
|---|-------------------|-----|------|---------------|-------------|-------------|-------------|
| Reception Desk with Transaction Counter 72"W x 36¾"D x 44"H | HLAM3772RD | 324 | 13.5 | \$1563 | \$35 | \$70 | \$25 |
|---|-------------------|-----|------|---------------|-------------|-------------|-------------|

NOTES: Non-handed. Counter measures 60"W x 15¼"D. Flat edge (G) matches 10500 Series™. For beaded (B) and tri-oval (V) edge shapes, the transaction counter is profiled on the approach and user sides, and the desk worksurface is profiled on the user's side. Beaded (B) and tri-oval (V) edges are available in L1 woodgrains colors only. Smooth and flat (G) edge available in all woodgrains and solid colors. Vertical grain on approach side and front accent panel for L1 laminates except Kingswood Walnut and Florence Walnut. Horizontal grain on L2 laminates and Kingswood and Florence Walnut. Vertical grain on end panels and horizontal grain on worksurface and transaction counter. Two worksurface cord management grommets for routing and hiding wires and cables; can be specified in Black (P) or Platinum (TI) finish.

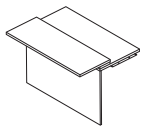

| | | | | | | | |
|---|-------------------|-----|-----|--------------|-------------|-------------|------------|
| Reception Return with 32'H Transaction Counter 48¼"W x 32⅞"D x 32"H | HLAM3348RR | 145 | 3.7 | \$879 | \$35 | \$35 | N/A |
|---|-------------------|-----|-----|--------------|-------------|-------------|------------|

NOTES: Non-handed. For use with HLAM3772RD and Reception Desk Shell (H105724). Counter facilitates accessibility; measures 48"W x 12"D x 32"H. Flat edge (G) matches 10500 Series™. For beaded (B) and tri-oval (V) edge shapes, the transaction counter is profiled on the approach side, and the return worksurface is profiled on the user's side. All other edges are flat banded. Beaded (B) and tri-oval (V) available in L1 woodgrain colors only. Flat edge (G) available in all woodgrains and solid colors. Pattern laminates do not have matching edge color; patterns can be specified with woodgrain or solid edge. Vertical grain on approach side, end panel, worksurface, and transaction counter. Assembly required. Cam covers used to allow for non-handed design.

Specify: Model.Edge Profile & EdgeColor.Worksurface & Counter Color.Chassis Color

SPECIFYING EXAMPLE: HLAM3348RR.GN.N.N

HOW TO SPECIFY

| | | | | | |
|---|---|--|--|--|---|
| Select Model Number H L A M 3 7 7 2 R D . | Select Edge Profile and Edge Color See page 29 G N . | Select Grommet Color P Black TI Platinum Not specified for model HLAM3348RR P . | Select Worksurface Laminate See page 29 N . | Select Chassis Laminate See page 29 N . | Select Accent Panel Laminate See page 29 Not specified for model HLAM3348RR L D W 1 |
|---|---|--|--|--|---|



CONCINNITY™ Reception Stations

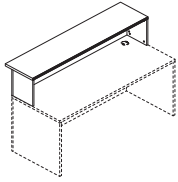

DESCRIPTION

Reception Station Counter for Desk
72"W x 17"D x 14 5/8"H

| MODEL | SHIP WEIGHT | CUBE | L1 LIST | L2 UPCHARGES | |
|------------------|-------------|------|--------------|--------------|-------------|
| | | | | COUNTER | CHASSIS |
| HNL1772RT | 74 | 4.3 | \$605 | \$10 | \$15 |

Compatible for use on 72"W x 30" or 36"D desktops and worksurfaces. For cleanest approach-side aesthetic, use on desk built with modular components; desk comprised of either 72"W x 30"D rectangle worksurface and 72"W x 27 7/8"H modesty/back panel, supported by 29 1/8"D pedestal(s) and/or end panel(s), or 72"W x 36"D worksurface and 72"W x 27 7/8"H modesty/back panel, supported by 35"D left and right end panels. The counter is 17"D with a 4" approach-side overhang; end panels are 12 3/8"D. Ships with Transaction counter organizer (model HTCOL52) is available as an option; fits under transaction counter; organizer is available in black only.

SPECIFYING EXAMPLE: HNL1772RT.BH.H.H

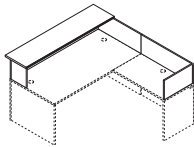

For Station with Right Return

L-Reception Station with Transaction Counter for Desk

72"W x 88"D x 14 5/8"H
72"W x 82"D x 14 5/8"H

| | | | | | |
|------------------|-----|-----|--------------|-------------|-------------|
| HNL8472RT | 103 | 4.5 | \$965 | \$10 | \$25 |
| HNL7872RT | 101 | 4.5 | \$941 | \$10 | \$25 |

NOTES: Intended for use on desk built with modular components, for clean approach-side aesthetic, connected to a return or modular return. Layout for 78" and 84"D footprints:

- 72"W x 78"D:
 - Desk = 72"W x 30"D worksurface, 72"W x 27 7/8"H modesty/back panel, supported by 29 1/8"D pedestal(s) and/or end panel(s).
 - Return = 48"W x 24"D return; or 48"W x 24"D worksurface with vertical grain, 48"W x 27 7/8"H modesty/back panel, supported by a 23 1/8"D pedestal and/or end panel.
- 72"W x 84"D:
 - Desk = 72"W x 36"D worksurface, 72"W x 27 7/8"H modesty/back panel, supported by 1-left and 1-right 35"D panel.
 - Return = 42"W x 24"D return; or 42"W x 24"D worksurface with vertical grain, 42"W x 27 7/8"H modesty/back panel, supported by a 23 1/8"D pedestal and/or end panel.
- 72"W x 88"D:
 - Desk = 72"W x 36"D worksurface, 72"W x 27 7/8"H modesty/back panel, supported by 1-left and 1-right 35"D end panel.
 - Return = 48"W x 24"D return; or 48"W x 24"D worksurface with vertical grain, 48"W x 27 7/8"H modesty/back panel, supported by a 23 1/8"D pedestal and/or end panel.

Comprised of 17"D transaction counter, with 4" approach-side overhang, for the desk and a vertical privacy panel extending the depth of the desk and width of the return. Ships with Transaction counter organizer (model HTCOL52) is available as an option; fits under transaction counter; organizer is available in black only.

SPECIFYING EXAMPLE: HNL8472RT.BH.H.H

NOTES:

- Reception Station Counter for Desk, and L-Reception Station with Transaction Counter for Desk, have profiled edgeband on the approach and user sides.
- L-Reception Station with Transaction Counter for Desk and Return has profiled edgeband on front side of transaction counter on desk approach-side only.
- For L-reception station layouts where the return is not against a wall, specify return using modular components, as the modesty/back panel can be specified without a grommet. Assembled returns come standard with cord grommet in modesty/back panel.

HOW TO SPECIFY

| | | | |
|--|--|--|--|
| <p>Select Model Number</p> <p>H N L 1 7 7 2 R T</p> | <p>Select Edge Profile and Edge Color</p> <p>See page 29</p> <p>B H</p> | <p>Select Counter Color</p> <p>See page 29</p> <p>H</p> | <p>Select Chassis Color</p> <p>See page 29</p> <p>H</p> |
|--|--|--|--|

CONCINNITY™

Reception Stations

GSA SIN 33721



Icon Legend on page 19

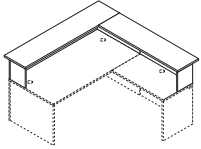

For Station with Right Return

| DESCRIPTION | MODEL | SHIP WEIGHT | CUBE | L1 LIST | L2 UPCHARGES | |
|--|-------------------|-------------|------|---------------|--------------|-------------|
| | | | | | COUNTER | CHASSIS |
| L-Reception Station with Transaction Counter for Desk and Return 76"W x 88"D x 14 $\frac{5}{8}$ "H | HNL8472RLT | 145 | 5.6 | \$1155 | \$10 | \$25 |
| 76"W x 82"D x 14 $\frac{5}{8}$ "H | HNL7872RLT | 139 | 5.6 | \$1115 | \$10 | \$25 |

NOTES: Intended for use on desk built with modular components, for clean approach-side aesthetic, connected to a return or modular return. Layout for 78" and 84"D footprints:

- 72"W x 78"D:
 - Desk = 72"W x 30"D worksurface, 72"W x 27 $\frac{7}{8}$ "H modesty/back panel, supported by 29 $\frac{1}{8}$ "D pedestal(s) and/or end panel(s).
 - Return = 48"W x 24"D worksurface with vertical grain, 48"W x 27 $\frac{7}{8}$ "H modesty/back panel, supported by a 23 $\frac{1}{8}$ "D pedestal and/or end panel.
- 72"W x 78"D:
 - Desk = 72"W x 36"D worksurface, 72"W x 27 $\frac{7}{8}$ "H modesty/back panel, supported by 1-left and 1-right 35"D panel.
 - Return = 42"W x 24"D worksurface with vertical grain, 42"W x 27 $\frac{7}{8}$ "H modesty/back panel, supported by a 23 $\frac{1}{8}$ "D pedestal and/or end panel.
- 72"W x 84"D:
 - Desk = 72"W x 36"D worksurface, 72"W x 27 $\frac{7}{8}$ "H modesty/back panel, supported by 1-left and 1-right 35"D end panel.
 - Return = 48"W x 24"D worksurface with vertical grain, 48"W x 27 $\frac{7}{8}$ "H modesty/back panel, supported by a 23 $\frac{1}{8}$ "D pedestal and/or end panel.

! The 17"D transaction counter, with 4" overhang, extends around the perimeter of the station, across the width of the desk, as well as along the depth of the desk and width of the return. Ships with Transaction counter organizer (model HTCOL52) is available as an option; fits under transaction counter; organizer is available in black only.

SPECIFYING EXAMPLE: HNL8472RLT.BH.H.H

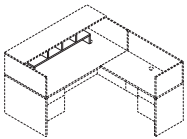

Transaction Counter Organizer

48 $\frac{3}{4}$ "W x 11 $\frac{1}{8}$ "D x 13"H

HTCOL52

24

1.1

\$300

N/A

N/A

NOTES: Fits under reception station counters.

! Black only.

SPECIFYING EXAMPLE: HTCOL52.P

NOTES:

- Reception Station Counter for Desk, and L-Reception Station with Transaction Counter for Desk, have profiled edgeband on the approach and user sides.
- ! L-Reception Station with Transaction Counter for Desk and Return has profiled edgeband on front side of transaction counter on desk approach-side only.
- ! For L-reception station layouts where the return is not against a wall, specify return using modular components, as the modesty/back panel can be specified without a grommet. Assembled returns come standard with cord grommet in modesty/back panel.

HOW TO SPECIFY

| | | | |
|---|---|---|---|
| Select Model Number H N L 8 4 7 2 R L T . | Select Edge Profile and Edge Color See page 29 B H . | Select Counter Color See page 29 H . | Select Chassis Color See page 29 H |
|---|---|---|---|



CONCINNITY™ Mobile Pedestals

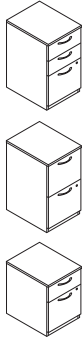

| DESCRIPTION | MODEL | SHIP WEIGHT | CUBE | L1 LIST | L2 UPCHARGES | | | |
|-------------------------------------|--------------------|-------------|------|--------------|--------------|-------------|-------------|--|
| | | | | | TOP | CHASSIS | FRONTS | |
| Mobile Pedestal — 15¾" W | | | | | | | | |
| 15¾"W x 20⅞"D x 28⅜"H, Box/Box/File | HNL2116MBBF | 69 | 7.4 | \$983 | N/A | \$20 | \$10 | |
| 15¾"W x 20⅞"D x 28⅜"H, File/File | HNL2116MFF | 70 | 7.4 | \$983 | N/A | \$20 | \$10 | |
| 15¾"W x 20⅞"D x 21½"H, Box/File | HNL2116MBF | 55 | 5.8 | \$833 | N/A | \$20 | \$10 | |

NOTES: Well suited to a variety of office layouts, including private, open floor plan, and cubicle workspaces. Design positions the center of gravity towards the back of the cabinet to inhibit tipping. All drawers lock; interchangeable core removable lock makes re-keying quick and easy. Finish of lock is determined by, and aligned with, the handle finish specified. Keyed alike cores must be ordered separately; specify model HF23B (Black) or HF23S (Satin) and specific key number required. Pedestals, excluding cushion option, are sized to be positioned under 29½"H worksurfaces. Seat cushion model HLSL2016PH2 is optional. Cushion adds 1" to the height of the pedestal. Box/File unit with cushion will fit below 29½"H worksurface. ¾" thick top with flat edgeband; back inside end panel construction. Ships fully assembled.

SPECIFYING EXAMPLE: HNL2116MBBF.E.H.H

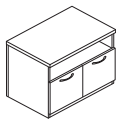

| | | | | | | | | |
|---|--------------------|-----|------|---------------|-------------|-------------|-------------|--|
| Mobile Pedestal — 30" W | | | | | | | | |
| 30"W x 20"D x 21½"H, Shelf/File/Cabinet | HNL2030MSFC | 105 | 10.7 | \$1235 | \$10 | \$25 | \$15 | |

NOTES: Sized to align with 20"D x 20½"H low credenzas. Open shelf over file drawer left and cabinet with door right. Design positions the center of gravity towards the back of the cabinet to inhibit tipping. Seat cushion model HNL2030CH2 is optional. Cushion adds 1" to the height of the pedestal. 1⅞" thick top matches low credenza design. Ships fully assembled.

SPECIFYING EXAMPLE: HNL2030MSFC.BH.E.H.H.H

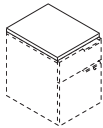

| DESCRIPTION | MODEL | SHIP WEIGHT | CUBE | LIST PRICE BY FABRIC GRADE | | | | | | |
|--------------------------------|--------------------|-------------|------|----------------------------|--------------|--------------|--------------|--------------|--------------|--|
| | | | | 1 | 2 | 3 | 4 | 5 | 6 | |
| Mobile Pedestal Cushion | | | | | | | | | | |
| 30"W x 20"D x 1"H | HLSL2030CH2 | 9 | 1.9 | \$418 | \$454 | \$490 | \$526 | \$572 | \$619 | |
| 15¾"W x 20"D x 1"H | HLSL2016PH2 | 6 | 1.1 | \$347 | \$371 | \$395 | \$419 | \$450 | \$481 | |

NOTES: See pages 22-24 for available fabrics.

SPECIFYING EXAMPLE: HLSL2016PH2.APN23

NOTES:

- Mobile pedestals roll easily on four casters to provide convenient, flexible placement of personal storage needs.
- Drawers operate on steel ball-bearing suspension with full extension.
- File drawers include hangrails for side-to-side letter and legal filing; and front-to-back for letter filing.
- ! 28⅜"H mobile pedestals are not designed for use with the 28½"H metal O-leg due to interference caused by (1) the O-leg worksurface attachment bracket, and (2) the external support channel on the underside of a 72", 66", and 60"W rectangle worksurface supported by O-leg(s).

HOW TO SPECIFY

| | | | |
|-----------------------------------|--|---|--|
| <p>Select Model Number</p> | <p>Select Handle</p> <p>A Cylinder – Satin B Cylinder – Black C Canopy – Satin D Canopy – Black E Loop – Satin F Loop – Black</p> | <p>Select Chassis Color</p> <p>See page 29</p> | <p>Select Drawer Front Color</p> <p>See page 29</p> |
| <p>H N L 2 1 1 6 M B B F .</p> | <p>E .</p> | <p>H .</p> | <p>H</p> |

| | | | | | |
|-----------------------------------|---|--|---|---|---|
| <p>Select Model Number</p> | <p>Select Edge Profile and Edge Color</p> <p>See page 29</p> | <p>Select Handle</p> <p>A Cylinder – Satin B Cylinder – Black C Canopy – Satin D Canopy – Black E Loop – Satin F Loop – Black</p> | <p>Select Top Color</p> <p>See page 29</p> | <p>Select Chassis Color</p> <p>See page 29</p> | <p>Select Drawer/Door Front Color</p> <p>See page 29</p> |
| <p>H N L 2 0 3 0 M S F C .</p> | <p>B H .</p> | <p>E .</p> | <p>H .</p> | <p>H .</p> | <p>H</p> |

CONCINNITY™ Lateral Files

GSA SIN 33721



Icon Legend on page 19

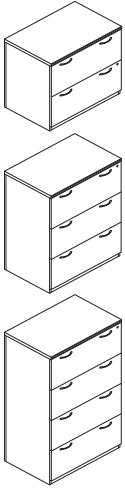

| DESCRIPTION | MODEL | SHIP WEIGHT | CUBE | L1 LIST | L2 UPCHARGES | | |
|--|-------------------|-------------|------|---------------|--------------|-------------|-------------|
| | | | | | TOP | CHASSIS | FRONTS |
| Lateral File 36"W x 24"D x 59½"H, 4-Drawer | HNL2436LD4 | 276 | 34.3 | \$2325 | \$15 | \$30 | \$30 |
| 36"W x 24"D x 45½"H, 3-Drawer | HNL2436LD3 | 222 | 26.0 | \$1928 | \$15 | \$25 | \$25 |
| 36"W x 24"D x 29½"H, 2-Drawer | HNL2436LD2 | 178 | 18.4 | \$1278 | \$15 | \$20 | \$20 |

NOTES: Equipped with safety restraints; mechanical interlock inhibits the extension of more than one drawer at a time; counterweight positions the center of gravity towards the back of the cabinet to inhibit tipping. 24" depth aligns evenly with credenzas, returns, storage cabinet, storage/file cabinet, storage cabinet/lateral file, wardrobe/storage cabinet, wardrobe/bookcase, storage towers, and 24"D modular components. 29½"H unit is sized to accommodate 36"W stack-on storage or bookcase hutch options. Drawers lock; interchangeable core removable lock makes re-keying quick and easy. Finish of lock is determined by, and aligned with, the handle finish specified. Keyed alike cores must be ordered separately; specify model HF23B (Black) or HF23S (Satin) and specific key number required. Ship fully assembled. 30"W two-drawer size can be specified and assembled using modular components. Drawers include hangrails to accept folders in letter or legal size.

SPECIFYING EXAMPLE: HNL2436LD2.BH.E.H.H.H

HOW TO SPECIFY

| | | | | | |
|--|--|--|--|--|---|
| <p>Select Model Number</p> <p>H N L 2 4 3 6 L D 4 .</p> | <p>Select Edge Profile and Edge Color</p> <p>See page 29</p> <p>B H .</p> | <p>Select Handle</p> <p>A Cylinder – Satin B Cylinder – Black C Canopy – Satin D Canopy – Black E Loop – Satin F Loop – Black</p> <p>E .</p> | <p>Select Top Color</p> <p>See page 29</p> <p>H .</p> | <p>Select Chassis Color</p> <p>See page 29</p> <p>H .</p> | <p>Select Drawer Front Color</p> <p>See page 29</p> <p>H .</p> |
|--|--|--|--|--|---|



CONCINNITY™ Storage Cabinets

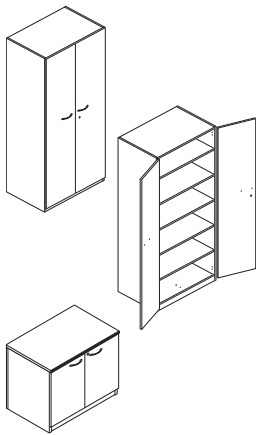

DESCRIPTION

Storage Cabinet with Laminate Doors

36"W x 24"D x 78 1/8"H (shown)
36"W x 24"D x 64 3/4"H
36"W x 24"D x 29 1/2"H

MODEL

HNL243679SC
HNL243665SC
HNL243629SC

SHIP WEIGHT

CUBE

L1 LIST

L2 UPCHARGES
TOP CHASSIS FRONTS

| | | | | | |
|-----|------|--------|------|------|------|
| 317 | 47.4 | \$2516 | N/A | \$60 | \$25 |
| 252 | 40.8 | \$2367 | N/A | \$55 | \$20 |
| 158 | 18.4 | \$1138 | \$15 | \$20 | \$20 |

NOTES: 29 1/2"H size has one adjustable interior shelf. Shelf adjusts in 2 1/2" increments over a total range of 10"H, 64 3/4"H and 78 1/8" have five shelves (four adjustable) and six shelves (five adjustable), respectively; shelves adjust in 2 1/2" increments. Locking doors. 24" depth aligns evenly with credenzas, returns, lateral files, storage/file cabinet, storage cabinet/lateral file, wardrobe/storage cabinet, wardrobe/bookcase, storage tower, bookcase with coat hook, and 24"D modular components. 29 1/2"H unit is sized to accommodate 36"W stack-on storage or bookcase hutch options. Ships fully assembled. 30"W x 24"D x 29 1/2"H freestanding unit can be built using modular components.

SPECIFYING EXAMPLE (29 1/2"H): HNL243629SC.BH.E.H.H.H
SPECIFYING EXAMPLE (64 3/4"-78 1/8"H): HNL243665SC.E.H.H

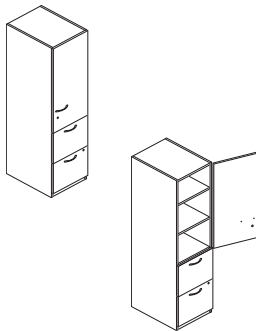

Storage/File Cabinet

18"W x 24"D x 64 3/4"H, File/File, Laminate
Door Hinged Right (shown)
18"W x 24"D x 64 3/4"H, File/File, Laminate
Door Hinged Left
18"W x 24"D x 64 3/4"H, File/File, Open
Shelves

HNL241865SFLR
HNL241865SFLL
HNL241865SFX

| | | | | | |
|-----|------|--------|-----|------|------|
| 184 | 21.6 | \$1903 | N/A | \$25 | \$15 |
| 184 | 21.6 | \$1903 | N/A | \$25 | \$15 |
| 169 | 21.6 | \$1807 | N/A | \$25 | \$15 |

NOTES: Versatile unit features a storage cabinet plus two file drawers. Storage cabinet includes three shelves, two are adjustable; shelves adjust in 2 1/2" increments. Can be specified with door hinged left, door hinged right, or no door/open shelves. File drawers operate on steel ball-bearing suspensions with full extension. File drawers include hangrails to accept folders in letter or legal size. Storage cabinet door and file drawers lock separately; the two locks are keyed alike. Unit height is designed to match desk, credenza, or return plus 35 1/4"H stack-on storage (= 64 3/4"). Ships fully assembled.

SPECIFYING EXAMPLE (WITH DOOR): HNL241865SFLR.E.H.H
SPECIFYING EXAMPLE (WITHOUT DOOR): HNL241865SFX.E.H.H

NOTES:

- Interchangeable core removable lock makes re-keying quick and easy.
- Finish of lock is determined by, and aligned with, the handle finish specified.
- Keyed alike cores must be ordered separately; specify model HF23B (Black) or HF23S (Satin) and specific key number required.

HOW TO SPECIFY

| | | | | | |
|--|--|---|--|--|---|
| <p>Select Model Number</p> <p>H N L 2 4 3 6 2 9 S C .</p> | <p>Select Edge Profile and Edge Color</p> <p>See page 29</p> <p>B H .</p> | <p>Select Handle</p> <p>A Cylinder - Satin B Cylinder - Black C Canopy - Satin D Canopy - Black E Loop - Satin F Loop - Black</p> <p>E .</p> | <p>Select Top Color</p> <p>See page 29</p> <p>H .</p> | <p>Select Chassis Color</p> <p>See page 29</p> <p>H .</p> | <p>Select Drawer Front Color</p> <p>See page 29</p> <p>H .</p> |
|--|--|---|--|--|---|

| | | | |
|---|--|---|--|
| <p>Select Model Number</p> <p>H N L 2 4 3 6 6 5 S C .</p> <p>H N L 2 4 1 8 6 5 S F X .</p> | <p>Select Handle</p> <p>A Cylinder - Satin B Cylinder - Black C Canopy - Satin D Canopy - Black E Loop - Satin F Loop - Black</p> <p>E .</p> <p>E .</p> | <p>Select Chassis Color</p> <p>See page 29</p> <p>H .</p> <p>H .</p> | <p>Select Drawer Front Color</p> <p>See page 29</p> <p>H .</p> <p>H .</p> |
|---|--|---|--|

CONCINNITY™ Storage Cabinets

GSA SIN 33721



Icon Legend on page 19

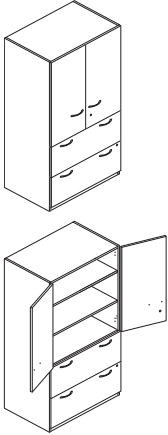

| DESCRIPTION | MODEL | SHIP WEIGHT | CUBE | L1 LIST | L2 UPCHARGES | | |
|--|---------------------|-------------|------|---------|--------------|---------|--------|
| | | | | | TOP | CHASSIS | FRONTS |
| Storage Cabinet/Lateral File, Laminate Doors 36"W x 24"D x 64¾"H | HNL243665SLL | 328 | 40.8 | \$2553 | N/A | \$55 | \$20 |

NOTES: Cabinet includes one fixed and two full-width adjustable shelves; adjustable shelves can be removed. Overall storage compartment measures 34"W x 22"D x 34½"H and will accommodate supplies, books and binders. Lateral file equipped with mechanical interlock to inhibit the extension of more than one drawer at a time. Lateral file drawers include hangrails to accept folders in letter or legal size. Storage cabinet and lateral file lock independently; upper lock secures cabinet; lower locks secure file drawers. Locks are keyed alike. Door hinges rotate to 94 degrees. Unit height is designed to match desk, credenza, or return plus 35¼"H stack-on storage (= 64¾"). Ships fully assembled.

SPECIFYING EXAMPLE: HNL243665SLL.E.H.H

NOTES:

- Interchangeable core removable lock makes re-keying quick and easy.
- Finish of lock is determined by, and aligned with, the handle finish specified.
- Keyed alike cores must be ordered separately; specify model HF23B (Black) or HF23S (Satin) and specific key number required.

HOW TO SPECIFY

| | | | |
|---|---|---|---|
| <p>Select Model Number</p> <p style="font-family: monospace; font-size: 1.2em; letter-spacing: 0.5em;">H N L 2 4 3 6 6 5 S L L .</p> | <p>Select Handle</p> <p>A Cylinder – Satin B Cylinder – Black C Canopy – Satin D Canopy – Black E Loop – Satin F Loop – Black</p> <p style="font-family: monospace; font-size: 1.2em; letter-spacing: 0.5em;">E .</p> | <p>Select Chassis Color</p> <p>See page 29</p> <p style="font-family: monospace; font-size: 1.2em; letter-spacing: 0.5em;">H .</p> | <p>Select Door/Drawer Front Color</p> <p>See page 29</p> <p style="font-family: monospace; font-size: 1.2em; letter-spacing: 0.5em;">H</p> |
|---|---|---|---|

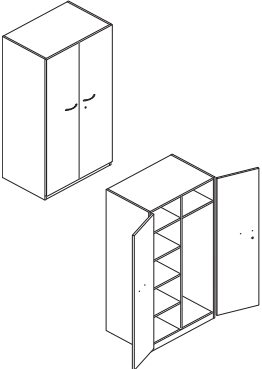
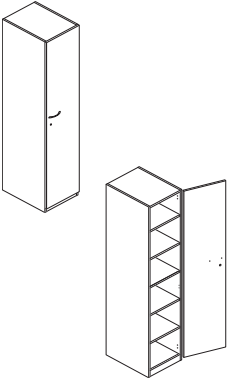
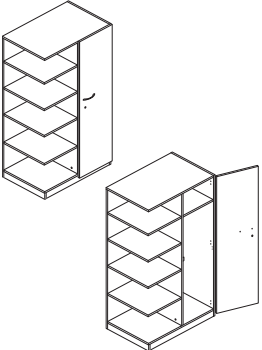

| DESCRIPTION | MODEL | SHIP WEIGHT | CUBE | L1 LIST | L2 UPCHARGES | |
|---|----------------------|-------------|------|---------------|--------------|-------------|
| | | | | | CHASSIS | FRONTS |
| Wardrobe/Storage Cabinet, Laminate Doors — 36"W 36"W x 24"D x 78 ¹ / ₈ "H 36"W x 24"D x 64 ³ / ₄ "H | HNL243679WL | 303 | 40.8 | \$2890 | \$60 | \$25 |
| | HNL243665WL | 284 | 40.8 | \$2771 | \$55 | \$20 |
| NOTES: Spacious design combines a cabinet with adjustable shelves and a generous personal wardrobe compartment with a coat rod and upper shelf. 64 ³ / ₄ "H and 78 ¹ / ₈ "H have five shelves (four adjustable) and six shelves (five adjustable), respectively; shelves adjust in 2 ¹ / ₂ " increments. One lock secures both doors. Ships fully assembled. SPECIFYING EXAMPLE: HNL243665WL.E.H.H | | | | | | |
|  | | | | | | |
| | | | | | | |
| Wardrobe/Storage Cabinet, Laminate Door — 18"W 18"W x 24"D x 78 ¹ / ₈ "H, Hinged Right (shown) 18"W x 24"D x 78 ¹ / ₈ "H, Hinged Left 18"W x 24"D x 64 ³ / ₄ "H, Hinged Right 18"W x 24"D x 64 ³ / ₄ "H, Hinged Left | HNL241879WLR | 205 | 24.8 | \$1897 | \$30 | \$20 |
| | HNL241879WLL | 205 | 24.8 | \$1897 | \$30 | \$20 |
| | HNL241865WLR | 157 | 21.6 | \$1739 | \$25 | \$15 |
| | HNL241865WLL | 157 | 21.6 | \$1739 | \$25 | \$15 |
| NOTES: Design includes coat rod and shelves. 64 ³ / ₄ "H and 78 ¹ / ₈ "H have five shelves (four adjustable) and six shelves (five adjustable), respectively; shelves adjust in 2 ¹ / ₂ " increments. Middle shelves can be removed to provide space for garments; coat rod can be removed for storage only applications. Lock to secure contents. Ships fully assembled. SPECIFYING EXAMPLE: HNL241865WLR.E.H.H | | | | | | |
|  | | | | | | |
| | | | | | | |
| Wardrobe/Bookcase, Laminate Door 36"W x 24"D x 78 ¹ / ₈ "H, Wardrobe Left, Bookcase Right 36"W x 24"D x 78 ¹ / ₈ "H, Wardrobe Right, Bookcase Left 36"W x 24"D x 64 ³ / ₄ "H, Wardrobe Left, Bookcase Right 36"W x 24"D x 64 ³ / ₄ "H, Wardrobe Right, Bookcase Left (shown) | HNL243679WLBR | 302 | 47.4 | \$2771 | \$60 | \$25 |
| | HNL243679WRBL | 302 | 47.4 | \$2771 | \$60 | \$25 |
| | HNL243665WLBR | 230 | 40.8 | \$2619 | \$55 | \$20 |
| | HNL243665WRBL | 230 | 40.8 | \$2619 | \$55 | \$20 |
| NOTES: Combination closed-door wardrobe closet and open shelf bookcase. 64 ³ / ₄ "H and 78 ¹ / ₈ "H bookcases have five and six fixed shelves, respectively. Locking wardrobe compartment includes a coat rod and one shelf; shelf is positioned above the coat rod. Bookcase can be accessed from front or side. Left (L) model is wardrobe on left, bookcase on right; Right (R) model is wardrobe on right, bookcase on left. Ships fully assembled. SPECIFYING EXAMPLE: HNL243665WRBL.E.H.H | | | | | | |
|  | | | | | | |
| | | | | | | |

NOTES:

- Heights designed to match desk, credenza, or return plus 35¹/₄"H stack-on storage (= 64³/₄"H) or 48⁵/₈"H stack-on storage (= 78¹/₈"H).
- Finish of locks is determined by, and aligned with, the handle finish specified.
- Keyed alike cores must be ordered separately; specify model HF23B (Black) or HF23S (Satin) and specific key number required.

HOW TO SPECIFY

| | | | |
|---|---|---|--|
| Select Model Number H N L 2 4 3 6 5 W L . | Select Handle A Cylinder – Satin B Cylinder – Black C Canopy – Satin D Canopy – Black E Loop – Satin F Loop – Black E . | Select Chassis Color See page 29 H . | Select Door Front Color See page 29 H |
|---|---|---|--|

CONCINNITY™

Storage Towers

GSA SIN 33721

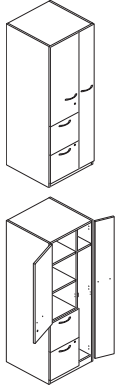

Icon Legend on page 19

**DESCRIPTION****Storage Towers, Laminate Doors — 24"W**24"W x 24"D x 78⁵/₈"H, Wardrobe Hinged Left, Cabinet Hinged Right**MODEL****HNL242479TLL****SHIP WEIGHT**

284

CUBE

32.4

L1 LIST**\$2684****L2 UPCHARGES****\$70****\$45**24"W x 24"D x 78⁵/₈"H, Wardrobe Hinged Right, Cabinet Hinged Left**HNL242479TLR**

284

32.4

\$2684**\$70****\$45**24"W x 24"D x 64³/₄"H, Wardrobe Hinged Left, Cabinet Hinged Right**HNL242465TLL**

241

27.6

\$2445**\$60****\$35**24"W x 24"D x 64³/₄"H, Wardrobe Hinged Right, Cabinet Hinged Left (shown)**HNL242465TLR**

241

27.6

\$2445**\$60****\$35**

NOTES: Versatile design includes a wardrobe closet, storage cabinet, and two file drawers, in one compact unit. Wardrobe contains a coat rod and upper shelf. 64³/₄"H and 78⁵/₈"H cabinets have three shelves (two adjustable) and four shelves (three adjustable), respectively; shelves adjust in 2¹/₂" increments. File drawers operate on ball-bearing suspensions with full extension. File drawer design includes integrated hangrails for side-to-side letter or legal filing; and front-to-back for letter filing. Upper lock secures wardrobe closet and storage cabinet; lower lock secures file drawers; the two locks are keyed alike. Left (L) model is wardrobe hinged left, cabinet hinged right; Right (R) model is wardrobe hinged right, cabinet hinged left. Ships fully assembled.

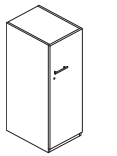
SPECIFYING EXAMPLE: HNL242465TLR.E.H.HHinged Right
HNL241850TLR shown**Storage Towers, Laminate Door — 50"H**

18"W x 30"D x 50"H, Hinged Right

HNL301850TLR

135

19.8

\$1515**\$50****\$35**

18"W x 30"D x 50"H, Hinged Left

HNL301850TLL

135

19.8

\$1515**\$50****\$35**

18"W x 24"D x 50"H, Hinged Right

HNL241850TLR

121

15.9

\$1362**\$50****\$35**

18"W x 24"D x 50"H, Hinged Left

HNL241850TLL

121

15.9

\$1362**\$50****\$35**

NOTES: Low profile design is well-suited for open plan layouts. Can be used next to 29¹/₂"H to standing, 42"H worksurfaces. Cabinet includes coat hook on back of door, perfect for jackets, sweaters, and purses. Two adjustable interior shelves, plus bottom of unit; shelves adjust in 2¹/₂" increments. 30"D size has a slim side access storage space at rear of unit with two fixed interior shelves; the lower shelf is positioned to align with a 29¹/₂"H worksurface, the upper shelf with a 42"H worksurface. Hardware bag includes an extra coat hook which can be positioned on the side of the unit, below the worksurface; ideal for back packs. Left (L) model is door hinged left; Right (R) model is door hinged right. Worksurface tower bracket kit (model HSTB2W1) can be used to attach a worksurface directly to the tower. Bracket (1) eliminates the need for one end panel or O-leg support; (2) is not designed to be used as a support when a stack-on storage unit is placed over bracket. Ships fully assembled.

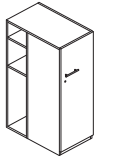
SPECIFYING EXAMPLE: HNL182450TLR.E.H.HHinged Right
HNL301850TLR shown**NOTES:**

- Equipped with interchangeable core removable locks.
- Finish of locks is determined by, and aligned with, the handle finish specified.
- Keyed alike cores must be ordered separately; specify model HF23B (Black) or HF23S (Satin) and specific key number required.

CABINET/WARDROBE/TOWER SOLUTIONS BY SIZE

| | Low/50"H | Standard/64 ³ / ₄ "H | Executive/78 ⁵ / ₈ "H |
|--|----------|--|---|
| Storage Cabinet with Doors | | • | • |
| Storage/File Cabinet | | • | |
| Storage Cabinet/Lateral File | | • | |
| Wardrobe/Storage Cabinet | | • | • |
| Wardrobe/Bookcase | | • | • |
| Storage Tower | | • | • |
| Storage Tower with Side Access on 30"D | • | | |
| Bookcase with Coat Hook | | • | |

HOW TO SPECIFYSelect
Model Number

H N L 2 4 2 4 6 5 T L R .

Select
Handle

- A Cylinder – Satin
- B Cylinder – Black
- C Canopy – Satin
- D Canopy – Black
- E Loop – Satin
- F Loop – Black

E .

Select
Chassis Color

See page 29

H .

Select
Door Front Color

See page 29

E

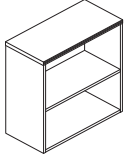

DESCRIPTION

Bookcase with Adjustable Shelves

- 30"W x 14 1/4"D x 78 1/8"H, 6-Shelf
- 30"W x 14 1/4"D x 65"H, 5-Shelf
- 30"W x 14 1/4"D x 52 3/4"H, 4-Shelf
- 30"W x 14 1/4"D x 42"H, 3-Shelf
- 30"W x 14 1/4"D x 29 1/2"H, 2-Shelf

| MODEL | SHIP WEIGHT | CUBE | L1 LIST | L2 UPCHARGES TOP | CHASSIS |
|-------------------|-------------|------|---------------|------------------|-------------|
| HNL1530BK6 | 170 | 25.7 | \$1037 | \$30 | \$35 |
| HNL1530BK5 | 143 | 21.1 | \$920 | \$25 | \$30 |
| HNL1530BK4 | 118 | 17.4 | \$798 | \$20 | \$25 |
| HNL1530BK3 | 95 | 14.1 | \$701 | \$15 | \$20 |
| HNL1530BK2 | 69 | 10.2 | \$616 | \$15 | \$15 |

NOTES: Profiled top edge; choose from edge detail options. Number of total and adjustable shelves:

| Height | Shelves | Adjustable Shelves |
|---------|---------|--------------------|
| 29 1/2" | 2 | 1 |
| 42" | 3 | 2 |
| 52 3/4" | 4 | 3 |
| 65" | 5 | 4 |
| 78 1/8" | 6 | 5 |

3/4" thick shelves adjust in 1/4" increments. Inside shelf dimensions on all units are 28 1/2"W x 13 1/4"D. Ships fully assembled.

SPECIFYING EXAMPLE: HNL1530BK2.BH.H.H

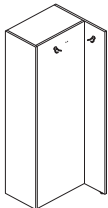
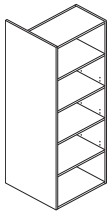

Back View

DESCRIPTION

Bookcase with Coat Hooks

- 24"W x 24"D x 64 3/4"H, 5-Shelf, with Coat Hooks, Right (shown)
- 24"W x 24"D x 64 3/4"H, 5-Shelf, with Coat Hooks, Left

| MODEL | SHIP WEIGHT | CUBE | L1 LIST PRICE | L2 UPCHARGE |
|---------------------|-------------|------|---------------|-------------|
| HNL2424BK5CR | 133 | 27.6 | \$1048 | \$30 |
| HNL2424BK5CL | 133 | 27.6 | \$1048 | \$30 |

NOTES: Inside shelf dimensions are 28 1/2"W x 13 1/4"D. Two out of sight coat hooks for garments are secluded behind bookcase. One end panel measures 14 1/4"D, the other 24"D. "R" indicates coat hook access is on the right and the full 24"D end panel is on the left; for use next to credenza or return with pedestal on right. "L" indicates coat hook access is on the left and the full 24"D end panel is on the right; for use next to credenza or return with pedestal on left. Unit height is designed to match desk, credenza, or return plus 35 1/4"H stack-on storage (= 64 3/4"). 3/4" thick, non-profiled top edge. Not available in two-tone laminate color combinations. Ships fully assembled.

SPECIFYING EXAMPLE: HNL2424BK5CR.H

HOW TO SPECIFY

| | | | |
|--|--|--|--|
| <p>Select Model Number</p> <p>H N L 1 5 3 0 B K 2 .</p> | <p>Select Edge Profile and Edge Color</p> <p>See page 29</p> <p>B H .</p> | <p>Select Top Color</p> <p>See page 29</p> <p>H .</p> | <p>Select Chassis Color</p> <p>See page 29</p> <p>H</p> |
| <p>Select Model Number</p> <p>H N L 2 4 2 4 B K 5 C R .</p> | <p>Select Laminate</p> <p>See page 29</p> <p>H</p> | | |

CONCINNITY™ COMPONENTS

MODULAR COMPONENTS

- Smart, adaptable, reconfigurable assortment to maximize office layout flexibility and optimize floor space.
- Components for all popular office layouts.
- Selection allows user to choose their own workstation shape, size, and storage.
- Sizes for large and small spaces:
 - 36"D x 72"W or 84"W
 - 30"D — six sizes up to 84"W
 - 24"D — in 6" increments, from 30"W to 96"W
- Worksurfaces supported by post legs with casters provide added layout flexibility.
- Mobile desks quickly convert an office into a small conference space; desks roll easily and can be repositioned in seconds.
- Grommet options provide cord management from the top, side, and back in appropriate models.
- Broad menu of under-surface storage to enable user to specify the solution that best meets their individual needs.
 - Non-handed units can be configured to meet individual tastes and reconfigured when preferences or floor space requirements change.
 - Applications include:
 - The ability to “build” contiguous customized/personalized storage behind the desk that looks like custom architectural millwork, but at a fraction of the price. Allows for multiple storage pedestals to be configured under a single top with clean lines and no gaps.
 - Choosing the storage solution to go under desks, credenzas, and returns.

WORKSURFACES

- Available in a variety of shapes and sizes.
- Scratch-, stain-, and spill-resistant laminate over durable 1½" solid core high performance particleboard; resists warping.
- An external support channel, for attachment under worksurfaces, is required for all unsupported spans — a distance in which there is not a vertical support (point of contact) between the underside of the worksurface and the floor — greater than 54"W.
- For tri-oval and beaded edge options on tops with horizontal grain, there is a shaped profile on the user and approach sides, and a flat edge on the ends.
- For tri-oval and beaded edge options on tops with vertical grain, there is a shaped profile on the user side and a flat edge on the approach side and the ends.
- Grommets are an option and require specification. If grommets are selected, grommets come in a pre-determined location.

- Must be specified with support components; for pedestal, end panel, column, and leg options, see “Components — Supports” listings.

SUPPORTS

- For use with rectangle, bow, bullet, and extended corner worksurfaces.
- Available in 28½" and 41"H.
- Adjustable hex glides allow floor-standing units to be easily leveled, without lifting, to compensate for uneven floors; glides have 1¼" adjustable range on most components; 2" on O-legs.
- Bottom of laminate end panels are edgebanded for added strength and to seal out moisture.

FOR 29½"H WORKSURFACES

- Specify from a broad assortment of solutions, including —
 - Modular Pedestals
 - Laminate end panels (must be used in conjunction with a laminate modesty panel)
 - Laminate L-shaped end panels
 - Laminate T-shaped end panels
 - Metal O-legs — for use with worksurfaces up to 78"W (when using an 84" or wider worksurface, cannot use two O-legs; must use at least one 15¾" or wider pedestal for the other support).
 - 4½" diameter metal column
 - 2" square metal post leg

FOR 42"H WORKSURFACES

- 42", fixed standing-height workstations give users the option of changing postures from sitting to standing throughout the day to help achieve their wellness goals.
- Specify supports from —
 - Modular Pedestals
 - Laminate end panels (must be used in conjunction with a laminate modesty panel)
 - Laminate L-shaped end panels
 - Metal O-legs
- When combined with a stool-height task chair, provides users the benefit of alternating their work between a seated or standing position.
- An external support channel, for attachment under worksurfaces, is required for all unsupported spans greater than 54"W.

- Worksurface End Support (panel, leg, column, base, pedestal) requirements by product type are as follows —
 - Desk, peninsula, or credenza — qty. 2
 - Return — qty. 1
 - Island extension — qty. 1

COORDINATE™ HEIGHT ADJUSTABLE BASE

- Multiple base options available.
- Height adjustable bases deliver a healthier style of working by allowing a seamless transition between sitting and standing throughout the day. For open, private, or training spaces.
- Frame rises from 21⁵/₈" to 47³/₄".
- Telescoping base design.
- Accommodates rectangle worksurface sizes 24" to 30"D and 42" to 72"W.
- Standard-height adjustable control included with base. Memory control allows preset worksurface heights for consistency.
- Shipped complete with a pre-assembled electric motor.

CONCINNITY™

Components — Worksurfaces

GSA SIN 33721



Icon Legend on page 19

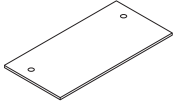

| DESCRIPTION | MODEL | SHIP WEIGHT | CUBE | L1 LIST PRICE | L2 UPCHARGE |
|--|------------------|-------------|------|---------------|-------------|
| Rectangle Worksurface with Horizontal Grain | | | | | |
| 84"W x 36"D | HNLRC3684 | 105 | 7.7 | \$701 | \$30 |
| 72"W x 36"D (shown) | HNLRC3672 | 90 | 6.7 | \$587 | \$30 |
| 84"W x 30"D | HNLRC3084 | 88 | 6.5 | \$567 | \$25 |
| 78"W x 30"D | HNLRC3078 | 81 | 6.1 | \$514 | \$25 |
| 72"W x 30"D | HNLRC3072 | 75 | 5.6 | \$470 | \$20 |
| 66"W x 30"D | HNLRC3066 | 69 | 5.2 | \$433 | \$20 |
| 60"W x 30"D | HNLRC3060 | 62 | 4.7 | \$404 | \$20 |
| 48"W x 30"D | HNLRC3048 | 50 | 3.9 | \$330 | \$15 |
| 96"W x 24"D | HNLRC2496 | 80 | 5.8 | \$583 | \$30 |
| 90"W x 24"D | HNLRC2490 | 75 | 5.5 | \$572 | \$30 |
| 84"W x 24"D | HNLRC2484 | 70 | 5.3 | \$540 | \$25 |
| 78"W x 24"D | HNLRC2478 | 65 | 4.9 | \$483 | \$20 |
| 72"W x 24"D | HNLRC2472 | 60 | 4.6 | \$402 | \$20 |
| 66"W x 24"D | HNLRC2466 | 55 | 4.2 | \$387 | \$20 |
| 60"W x 24"D | HNLRC2460 | 50 | 3.9 | \$358 | \$20 |
| 54"W x 24"D | HNLRC2454 | 45 | 3.5 | \$328 | \$20 |
| 48"W x 24"D | HNLRC2448 | 40 | 3.1 | \$302 | \$15 |
| 42"W x 24"D | HNLRC2442 | 35 | 2.8 | \$281 | \$15 |
| 36"W x 24"D Rectangle Worksurface/Pedestal Top | HNLRC2436 | 30 | 2.4 | \$253 | \$15 |
| 30"W x 24"D Rectangle Worksurface/Pedestal Top | HNLRC2430 | 25 | 2.1 | \$253 | \$15 |

NOTES: See chart on page 34 for cord management options.

- When grommets are specified for 30"D and 36"D rectangle worksurfaces, pre-drilled holes will not be included for a 4½" diameter support column.

NOTES:

- Grain direction on all rectangle worksurfaces runs horizontal (side-to-side) except as follows: 30"W - 36"W - 42"W - 48"W - 54"W - 60"W x 24"D tops can be specified with horizontal (side-to-side) or vertical (front-to-back) grain.
- 42"W and 48"W x 20"D tops are available with vertical (front-to-back) grain only.
- For standing-height requirements, use worksurface with 41"H O-leg, end panel, L-shaped end panel, or pedestal supports.
- For mobile desks and tables, use post leg with casters.
- For paper organizers, see page 108.
- If using worksurfaces with Coordinate™ Height Adjustable Bases, an External Stiffener must be used.
- Attachment of above privacy screen models requires a minimum 1" clear space/overhang on the underside of worksurface.
- Worksurfaces used with Coordinate™ Height Adjustable Bases should have 1" perimeter gap on each side to provide clearance between other furniture. Failure to do so risks injury or product damage (not covered by warranty).
- When using end panels or O-legs with 84", 90", or 96"W worksurfaces, interior weight-bearing support components are required to minimize worksurface deflection.
- Attachment of above/below privacy screen models requires a minimum 2" clear space/overhang on the underside of the worksurface.
- Steel external support channel can be attached to the underside of worksurfaces that are subjected to heavier loads. Channel is recommended to provide extra support on unsupported spans of 54"W or greater or per user preference. Ordered separately from worksurface.
- If using a 54"W or 60"W floating modesty panel, it is not necessary to specify an external support channel.
- When using an external support channel under the worksurface, the depth clearance for center drawers and keyboard platforms decreases by 8".
- See "External Channel (Recommended Use)" chart on page 83.

HOW TO SPECIFY

| | | | |
|---|--|--|--|
| Select Model Number See page 29 H N L R C 3 6 8 4 | Select Edge Profile and Edge Color See page 29 B H | Select Worksurface Grommet Finish P Black T1 Platinum X No Grommet P | Select Worksurface Color See page 29 H |
|---|--|--|--|



CONCINNITY™

Components — Worksurfaces

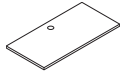

| DESCRIPTION | MODEL | SHIP WEIGHT | CUBE | L1 LIST PRICE | L2 UPCHARGE |
|--|-------------------|-------------|------|---------------|-------------|
| Rectangle Worksurface with Vertical Grain | | | | | |
| 60"W x 24"D | HNLRC2460V | 50 | 3.9 | \$358 | \$20 |
| 54"W x 24"D | HNLRC2454V | 45 | 3.5 | \$328 | \$20 |
| 48"W x 24"D (shown) | HNLRC2448V | 40 | 3.1 | \$302 | \$15 |
| 42"W x 24"D | HNLRC2442V | 35 | 2.8 | \$281 | \$15 |
| 36"W x 24"D Rectangle Worksurface/Pedestal Top | HNLRC2436V | 30 | 2.4 | \$253 | \$15 |
| 30"W x 24"D Rectangle Worksurface/Pedestal Top | HNLRC2430V | 25 | 2.1 | \$253 | \$15 |
| 48"W x 20"D | HNLRC2048V | 33 | 2.7 | \$282 | \$10 |
| 42"W x 20"D | HNLRC2042V | 29 | 2.3 | \$260 | \$10 |

NOTES: Can be used in a host of applications, including as a desk, credenza, return, bridge, stationary or mobile table surface, in U- or L-shaped configurations, as part of a work wall layout with an island extension, or with the height adjustable electric base. The conference overhang dimension on the approach side of worksurfaces varies depending on the supports and modesty panels specified. Top can be positioned with a cantilevered conference overhang on one end when used with select worksurface supports, including an O-leg or 9½"W modular pedestal. For return applications in which there is an unsupported span wider than 54", such as a 72"W x 24"D worksurface supported by a 15¾"W modular pedestal (= 56¼") or a 60"W x 24"D worksurface supported by a 1½" thick end panel (= 58¾"), use internal support panel model HNL11SUPP. For bridges wider than 54", use internal support panel HNL11SUPP. When using a 30"W, 36"W, 42"W, or 48"W rectangle worksurface as a bridge, no support legs are needed. When specifying a 84"W, 90"W, or 96"W worksurface, cannot use two O-legs for the supports. In these applications, the maximum number of supports that can be an O-leg is one; must choose from a 15¾" or wider modular pedestal for use as the additional support component. For applications requiring connection to an adjoining worksurface, two flat brackets are included with 24"D and 20"D worksurfaces that are ≤48"W; one flat bracket is included with 24"D worksurfaces that are ≥54"W. Underside of worksurface includes pilot mounting holes for O-leg, 1½" thick laminate end panel, pedestals, and flat brackets. See chart on page 34 for cord management options.

ⓘ When grommets are specified for 30"D and 36"D rectangle worksurfaces, pre-drilled holes will not be included for attachment of a 4½" diameter support column.

NOTES:

- Grain direction on all rectangle worksurfaces runs horizontal (side-to-side) except as follows: 30"W - 36"W - 42"W - 48"W - 54"W - 60"W x 24"D tops can be specified with horizontal (side-to-side) or vertical (front-to-back) grain.
- 42"W and 48"W x 20"D tops are available with vertical (front-to-back) grain only.
- For standing-height requirements, use worksurface with 41"H O-leg, end panel, L-shaped end panel, or pedestal supports.
- For mobile desks and tables, use post leg with casters.
- For paper organizers, see page 108.
- ⓘ If using worksurfaces with Coordinate™ Height Adjustable Bases, an External Stiffener must be used.
- ⓘ Attachment of above privacy screen models requires a minimum 1" clear space/overhang on the underside of worksurface.
- ⓘ Worksurfaces used with Coordinate™ Height Adjustable Bases should have 1" perimeter gap on each side to provide clearance between other furniture. Failure to do so risks injury or product damage (not covered by warranty).
- ⓘ Attachment of above/below privacy screen models requires a minimum 2" clear space/overhang on the underside of the worksurface.
- ⓘ Steel external support channel can be attached to the underside of worksurfaces that are subjected to heavier loads. Channel is recommended to provide extra support on unsupported spans of 54"W or greater or per user preference. Ordered separately from worksurface.
- ⓘ If using a 54"W or 60"W floating modesty panel, it is not necessary to specify an external support channel.
- ⓘ When using an external support channel under the worksurface, the depth clearance for center drawers and keyboard platforms decreases by 8".
- ⓘ See "External Channel (Recommended Use)" chart on page 83.

HOW TO SPECIFY

| | | | |
|---|--|---|--|
| Select Model Number See page 29 H N L R C 2 4 6 0 V | Select Edge Profile and Edge Color See page 29 B H | Select Worksurface Grommet Finish P Black T1 Platinum X No Grommet P | Select Worksurface Color See page 29 H |
|---|--|---|--|

CONCINNITY™

Components — Worksurfaces

GSA SIN 33721

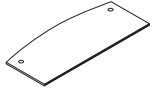

Icon Legend on page 19

**DESCRIPTION****Bow Worksurface**

84"W x 36"D

72"W x 36"D

MODEL**HNLBW3684****HNLBW3672****SHIP WEIGHT**

94

80

CUBE

7.7

6.7

L1 LIST PRICE**\$748****\$675****L2 UPCHARGE****\$30****\$30**

NOTES: 84"W size is ideal for executive layouts or for user's who require additional worksurface space. 72"W top can be combined with different pedestal support options to allow users to personalize their storage needs. Underside of worksurface includes pilot mounting holes for 1½" and L-shaped laminate end panels, and 29½"D pedestals. Grain direction runs horizontal (side-to-side). See chart on page 34 for cord management options.

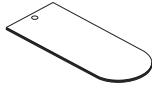
**Bullet Worksurface**

84"W x 30"D

78"W x 30"D

72"W x 30"D

66"W x 30"D

60"W x 30"D

48"W x 30"D

HNLBU3084**HNLBU3078****HNLBU3072****HNLBU3066****HNLBU3060****HNLBU3048**

84

78

72

66

60

54

6.3

6.3

5.5

5.5

4.7

3.7

\$660**\$628****\$545****\$521****\$484****\$424****\$25****\$20****\$20****\$20****\$20****\$15**

NOTES: Applications include U- or L-shaped peninsula configurations and island extensions. Underside of worksurface includes pilot mounting holes for O-leg, T-shaped end panel, 29½"D pedestals, 4½" diameter support column, and 2" square post leg. One flat bracket is packaged with each worksurface for applications requiring connection to an adjoining worksurface. Grain direction runs horizontal (side-to-side). Can be used in combination with a 15¾"W or 9½"W x 29½"D x 28¼"H modular pedestal to create a freestanding desk. See chart on page 34 for cord management options.

NOTES:

- ❗ When specifying an 84"W size, cannot use two O-legs; must use another type of support component such as a pedestal.
- ❗ Steel external support channel can be attached to the underside of worksurfaces that are subjected to heavier loads. Channel is recommended to provide extra support on unsupported spans of 54"W or greater or per user preference. Ordered separately from worksurface.
- ❗ If using a 54"W or 60"W floating modesty panel, it is not necessary to specify an external support channel.
- ❗ When using an external support channel under the worksurface, the depth clearance for center drawers and keyboard platforms decreases by 8".
- ❗ See "External Channel (Recommended Use)" chart on page 83.

HOW TO SPECIFY**Select Model Number**

H N L B W 3 6 8 4 .

Select Edge Profile and Edge Color

See page 29

B H .

Select Worksurface Grommet Finish

P Black
 T1 Platinum
 X No Grommet

P .

Select Worksurface Color

See page 29

H



CONCINNITY™ Components — Worksurfaces

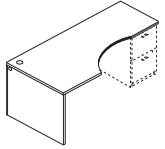

Right-hand model
HNLEC367224R shown

| DESCRIPTION | MODEL | SHIP WEIGHT | CUBE | L1 LIST | L2 UPCHARGES | |
|------------------------------------|---------------------|-------------|------|---------------|--------------|-------------|
| | | | | | WORKSURFACE | END PANEL |
| Extended Corner Worksurface | | | | | | |
| 72"W x 48"D, Right | HNLEC487224R | 130 | 8.9 | \$1138 | \$50 | \$50 |
| 72"W x 48"D, Left | HNLEC487224L | 130 | 8.9 | \$1138 | \$50 | \$50 |
| 72"W x 36"D, Right | HNLEC367224R | 106 | 6.6 | \$941 | \$45 | \$45 |
| 72"W x 36"D, Left | HNLEC367224L | 106 | 6.6 | \$941 | \$45 | \$45 |

NOTES: For use in U- or L-shaped layouts. Includes top and long (47"D or 35"D) end panel components. Installation also requires modesty panel and either a 1½" thick end panel or 15¾" x 23⅜"D pedestal support for opposite end; both ordered separately. 72"W x 24/48"D or 48/24"D top is intended for use with 30/48"D or 48/30"D jetty peninsula to create a 2-piece "U" station with a curved cockpit on user's side. 72"W x 24/36"D or 36/24"D size is intended for use with 24"D returns or bridges. Underside of worksurface has pilot mounting holes for 1½" thick end panel and 15¾" x 23⅜"D modular pedestal. Edgebanding on the extended corner worksurface is profiled on the user's side and flat on the back (approach side) and ends. Grain direction runs horizontal (side-to-side).

❗ One flat bracket is packaged with each 48"D worksurface for applications requiring connection to a 48"D jetty peninsula. For 36"D extended corner worksurface, the flat bracket is shipped with the adjoining return or bridge. See chart on page 34 for cord management options. If grommet option is chosen, the worksurface component will match the color specified; the long end panel grommet color will be black.

NOTES:

- ❗ When specifying an 84"W size, cannot use two O-legs; must use another type of support component such as a pedestal.
- ❗ Steel external support channel can be attached to the underside of worksurfaces that are subjected to heavier loads. Channel is recommended to provide extra support on unsupported spans of 54"W or greater or per user preference. Ordered separately from worksurface.
- ❗ If using a 54"W or 60"W floating modesty panel, it is not necessary to specify an external support channel.
- ❗ When using an external support channel under the worksurface, the depth clearance for center drawers and keyboard platforms decreases by 8".
- ❗ See "External Channel (Recommended Use)" chart on page 83.

HOW TO SPECIFY

| | | | | |
|---|---|--|--|--|
| <p>Select Model Number</p> <p>HNLEC487224R</p> | <p>Select Edge Profile and Edge Color</p> <p>See page 29</p> <p>BH</p> | <p>Select Worksurface Grommet Finish</p> <p>P Black T1 Platinum X No Grommet</p> <p>X</p> | <p>Select Worksurface Color</p> <p>See page 29</p> <p>H</p> | <p>Select End Panel Color</p> <p>See page 29</p> <p>H</p> |
|---|---|--|--|--|

CONCINNITY™

Components — Supports

GSA SIN 33721 EXCEPT AS NOTED

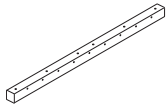

Icon Legend on page 19

**DESCRIPTION****External Support Channel**

72"W for a 78" Worksurface
 66"W for a 72" Worksurface
 60"W for a 66" Worksurface
 54"W for a 60" Worksurface
 48"W for a 54" Worksurface

MODEL

HLSLZ5SC84
HLSLZ5SC78
HLSLZ5SC72
HLSLZ5SC66
HLSLZ5SC60

SHIP WEIGHT

12
 7
 7
 7
 6

CUBE

0.7
 0.5
 0.5
 0.5
 0.5

LIST PRICE

\$119
\$119
\$119
\$110
\$106

! Available in Graphite paint only.

! Attaches to underside of worksurface; required for unsupported spans greater than 54"W.

! When specifying a 54"W or 60"W Floating Modesty Panel, it is not necessary to specify an external channel.

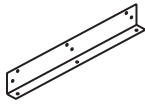

HVPWLBK24 shown

OPEN MARKET

Worksurface Wall Mount Bracket

For 30"
 For 24"

HVPWLBK30
HVPWLBK24

2
 2

0.3
 0.3

\$99
\$90

NOTES: Can be used in place of an end panel to support a worksurface. Cannot be used as a support when placing a stack-on storage unit on worksurface over bracket; must have two full-sized floor supports when using stack-on storage. Finish option not required.

SPECIFYING EXAMPLE: HVPWLBK30

**DESCRIPTION****Worksurface to Tower Bracket Kit**

18½" long bracket for attaching 24"D worksurface directly to storage tower, wardrobe/bookcase, wardrobe/storage cabinet, storage cabinet/lateral file, storage cabinet, or lateral file.

MODEL**HSTB2W1****SHIP WEIGHT**

4

CUBE

0.6

LIST PRICE BY PAINT GRADE**P1****\$88****P2****\$101****P3****\$103**

NOTES: Can be used in place of end panel or O-leg to support worksurfaces.

! Bracket not designed for use as a support if placing Stack-on Storage on worksurface over/above bracket. Two full-sized supports required when using Stack-on Storage.

NOTES:

• Use the worksurface to tower bracket kit to attach worksurfaces to Storage Tower models.

! Depending on your support combination, an external channel may be required for extra support on unsupported spans greater than 54"W.

HOW TO SPECIFY

Select
 Model Number

H L S L Z 5 S C 8 4

HNL Support Options — External Channel (model HLSLZ5SCxx) - Recommended Use

| | Support Combination | | Worksurface Width | | | | | | | | | | | |
|----------------------|---------------------|--------------|-------------------|-----|-----|-----|-----|-----|-----|-----|-----|-----|-----|-----|
| | Support 1 | Support 2 | 30" | 36" | 42" | 48" | 54" | 60" | 66" | 72" | 78" | 84" | 90" | 96" |
| O-LEG ON ONE END | O-Leg | O-Leg | NR | NR | NR | NR | 60 | 66 | 72 | 78 | 84 | NA | NA | NA |
| | O-Leg | 9½"W Ped | NR | NR | NR | NR | NR | 60 | 66 | 72 | 78 | 84 | NA | NA |
| | O-Leg | End Bookcase | NA | NR | NR | NR | NR | NR | 60 | 66 | 72 | 78 | 84 | NA |
| | O-Leg | L End Panel | NR | NR | NR | NR | NR | 60 | 66 | 72 | 78 | 84 | NA | NA |
| | O-Leg | 15¾"W Ped | NA | NR | NR | NR | NR | NR | NR | 60 | 66 | 72 | 78 | NA |
| | O-Leg | 18"W Ped | NA | NA | NR | NR | NR | NR | NR | 60 | 66 | 72 | 78 | 84 |
| | O-Leg | 30"W Ped | NA | NA | NA | NA | NR | NR | NR | NR | NR | 60 | 66 | 72 |
| | O-Leg | 36"W Ped | NA | NA | NA | NA | NA | NR | NR | NR | NR | NR | 60 | 66 |
| | NARROW PED | 9½"W Ped | 9½"W Ped | NA | NA | NR | NR | NR | NR | NR | 60 | 66 | 72 | 78 |
| 9½"W Ped | | End Bookcase | NA | NA | NR | NR | NR | NR | NR | 60 | 66 | 72 | 78 | 84 |
| 9½"W Ped | | L End Panel | NA | NR | NR | NR | NR | NR | 60 | 66 | 72 | 78 | 84 | NA |
| 9½"W Ped | | 15¾"W Ped | NA | NA | NA | NR | NR | NR | NR | NR | 60 | 66 | 72 | 78 |
| 9½"W Ped | | 18"W Ped | NA | NA | NA | NR | NR | NR | NR | NR | 60 | 66 | 72 | 78 |
| 9½"W Ped | | 30"W Ped | NA | NA | NA | NA | NA | NR | NR | NR | NR | NR | 60 | 66 |
| 9½"W Ped | | 36"W Ped | NA | NA | NA | NA | NA | NA | NR | NR | NR | NR | NR | 60 |
| END BOOKCASE PED | End Bookcase | End Bookcase | NA | NA | NR | NR | NR | NR | NR | NR | 60 | 66 | 72 | 78 |
| | End Bookcase | L End Panel | NA | NA | NR | NR | NR | NR | NR | 60 | 66 | 72 | 78 | 84 |
| | End Bookcase | 15¾"W Ped | NA | NA | NA | NR | NR | NR | NR | NR | 60 | 66 | 72 | 78 |
| | End Bookcase | 18"W Ped | NA | NA | NA | NR | NR | NR | NR | NR | 60 | 66 | 72 | 78 |
| | End Bookcase | 30"W Ped | NA | NA | NA | NA | NA | NR | NR | NR | NR | NR | 60 | |
| | End Bookcase | 36"W Ped | NA | NA | NA | NA | NA | NA | NR | NR | NR | NR | NR | |
| L END PANEL | L End Panel | L End Panel | NA | NR | NR | NR | NR | NR | 60 | 66 | 72 | 78 | 84 | NA |
| | L End Panel | 15¾"W Ped | NA | NA | NR | NR | NR | NR | NR | NR | 60 | 66 | 72 | 78 |
| | L End Panel | 18"W Ped | NA | NA | NA | NR | NR | NR | NR | NR | 60 | 66 | 72 | 78 |
| | L End Panel | 30"W Ped | NA | NA | NA | NA | NA | NR | NR | NR | NR | NR | 60 | 66 |
| | L End Panel | 36"W Ped | NA | NA | NA | NA | NA | NA | NR | NR | NR | NR | NR | 60 |
| TWO PEDS | 15¾"W Ped | 15¾"W Ped | NA | NA | NA | NA | NR | NR | NR | NR | NR | 60 | 66 | 72 |
| | 15¾"W Ped | 18"W Ped | NA | NA | NA | NA | NR | NR | NR | NR | NR | 60 | 66 | 72 |
| | 15¾"W Ped | 30"W Ped | NA | NA | NA | NA | NA | NR | NR | NR | NR | NR | NR | 60 |
| | 15¾"W Ped | 36"W Ped | NA | NA | NA | NA | NA | NA | NR | NR | NR | NR | NR | 60 |
| | 18"W Ped | 18"W Ped | NA | NR | NA | NA | NR | NR | NR | NR | NR | NR | 60 | 66 |
| | 18"W Ped | 30"W Ped | NA | NA | NA | NR | NA | NA | NR | NR | NR | NR | NR | 60 |
| | 18"W Ped | 36"W Ped | NA | NA | NA | NA | NA | NA | NR | NR | NR | NR | NR | 60 |
| | 30"W Ped | 30"W Ped | NA | NA | NA | NA | NA | NR | NR | NR | NR | NR | NR | 60 |
| | 30"W Ped | 36"W Ped | NA | NA | NA | NA | NA | NR | NR | NR | NR | NR | NR | 60 |
| | 36"W Ped | 36"W Ped | NA | NA | NA | NA | NA | NR | NR | NR | NR | NR | NR | 60 |
| RETURN CONFIGURATION | None | O-Leg | NR | NR | NR | NR | 60 | 66 | 72 | 78 | 84 | NA | NA | NA |
| | None | 9½"W Ped | NR | NR | NR | NR | NR | 60 | 66 | 72 | 78 | 84 | NA | NA |
| | None | End Bookcase | NA | NR | NR | NR | NR | NR | 60 | 66 | 72 | 78 | 84 | NA |
| | None | L End Panel | NR | NR | NR | NR | NR | 60 | 66 | 72 | 78 | 84 | NA | NA |
| | None | 15¾"W Ped | NA | NR | NR | NR | NR | NR | NR | 60 | 66 | 72 | 78 | NA |
| | None | 18"W Ped | NA | NA | NR | NR | NR | NR | NR | 60 | 66 | 72 | 78 | 84 |
| | None | 30"W Ped | NA | NA | NA | NA | NR | NR | NR | NR | NR | 60 | 66 | 72 |
| | None | 36"W Ped | NA | NA | NA | NA | NA | NR | NR | NR | NR | NR | 60 | 66 |

NA = Stiffener not applicable due to invalid worksurface width and support combination

NR = Applicable worksurface width and support combination, but stiffener not required

! The chart reference is to be used to complete the model number. It is not the actual length dimension of the external support channel.

CONCINNITY™

Components — Modesty/Back Panels

GSA SIN 33721

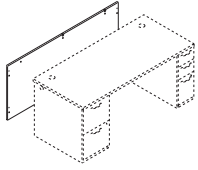

Icon Legend on page 19

**DESCRIPTION****Modesty/Back Panels — Full-Length**

96"W x 27¹/₈"H
 90"W x 27¹/₈"H
 84"W x 27¹/₈"H
 78"W x 27¹/₈"H
 72"W x 27¹/₈"H
 66"W x 27¹/₈"H
 60"W x 27¹/₈"H
 54"W x 27¹/₈"H
 48"W x 27¹/₈"H
 42"W x 27¹/₈"H

MODEL

HNLMP9628
HNLMP9028
HNLMP8428
HNLMP7828
HNLMP7228
HNLMP6628
HNLMP6028
HNLMP5428
HNLMP4828
HNLMP4228

SHIP WEIGHT

62
58
54
50
46
42
38
34
30
26

CUBE

7.2
6.7
6.1
5.5
5.3
4.8
4.4
4.0
3.6
3.2

L1 LIST PRICE

\$471
\$459
\$381
\$338
\$314
\$295
\$267
\$258
\$244
\$224

L2 UPCHARGE

\$25
\$25
\$25
\$20
\$20
\$20
\$20
\$20
\$15
\$15

36"W x 27¹/₈"H Modesty/Pedestal Back Panel
 30"W x 27¹/₈"H Modesty/Pedestal Back Panel

HNLMP3628
HNLMP3028

22
18

2.8
2.4

\$208
\$192

\$12
\$12

Modesty/Back Panels — Short

96"W x 10"H
 90"W x 10"H
 84"W x 10"H
 78"W x 10"H
 72"W x 10"H
 66"W x 10"H
 60"W x 10"H
 54"W x 10"H
 48"W x 10"H
 42"W x 10"H
 36"W x 10"H
 30"W x 10"H

HNLMP9610
HNLMP9010
HNLMP8410
HNLMP7810
HNLMP7210
HNLMP6610
HNLMP6010
HNLMP5410
HNLMP4810
HNLMP4210
HNLMP3610
HNLMP3010

22
21
20
19
18
17
16
15
14
13
12
11

3.0
2.8
2.8
2.3
2.1
1.9
1.8
1.6
1.4
1.3
1.1
0.9

\$471
\$459
\$381
\$338
\$314
\$295
\$267
\$258
\$244
\$224
\$208
\$192

\$15
\$15
\$15
\$12
\$12
\$12
\$12
\$12
\$10
\$10
\$10
\$10

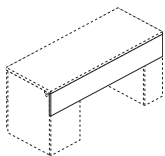

Back View

NOTES: For use with modular worksurface and support components. Component is 3/4" thick. Full-to-floor sizes can be specified with or without grommet; see chart on page 34 for cord management options. For standing-height applications, a worksurface supported by 1 1/8" thick x 41"H laminate end panel(s) and/or 41"H support pedestal(s), the recommended modesty panel length extends 27 1/8" below the underside of the top, leaving 13" of wall access; 9 1/2" and 15 3/4" W x 13"H backs are available to enclose the balance of the pedestal back. Worksurfaces supported by a 1 1/8" thick x 41"H laminate end panel and 41"H support pedestal, or by two 41"H support pedestals, can be used with a 10" modesty panel to increase the amount of wall access, however in this application the pedestal(s) should be positioned against a wall, as there is not a 30 7/8"H panel to cover the back of the pedestal that is exposed below the modesty panel. The 10"H modesty panel is not recommended for use in a standing-height shell, where both supports are 41"H laminate end panels; for this solution use the 27 1/8"H modesty panel. For standing-height applications with the worksurface supported by 41"H O-legs or L-shaped end panels, use the appropriate floating modesty panel size.

NOTES:

- Provide approach-side kneespace privacy for user seated at desks, credenzas, returns, and bridges.
- Full-width laminate panel can be specified in 6" increments from 30"-96"W, and in full-length (27 1/8"H) or short (10"H).
- Formal, full-length, 27 1/8"H models extend from the underside of the worksurface to the floor.
- 10"H sizes allow quick and easy access to wall power outlets.
- 30"W and 36"W x 27 1/8"H are sized to serve as a modesty panel, or pedestal back for respective 30"W and 36"W support storage pedestal models.

! The full-width panel designs are specifically for use when the worksurface supports are two 1 1/8" thick end panels, two support storage pedestals, or one 1 1/8" thick end panel and one support storage pedestal; not for use with O-legs or L-shaped end panels.

HOW TO SPECIFY

| | | |
|---|--|--|
| Select Model Number H N L M P 7 2 2 8 | Select Grommet P Black X No Grommet | Select Laminate Color See page 29 H |
| Select Model Number H N L M P 7 2 1 0 | Select Laminate Color See page 29 H | |



CONCINNITY™

Components — Modesty/Back Panels

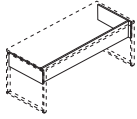

Not available in two-tone laminate

| DESCRIPTION | MODEL | SHIP WEIGHT | CUBE | L1 LIST PRICE | L2 UPCHARGE |
|---|-------------------|-------------|------|---------------|-------------|
| Modesty Panels for Desks with O-Legs | | | | | |
| 68 $\frac{3}{8}$ "W x $\frac{3}{4}$ "D x 10"H — For 72" x 30" Desks | HLAMMP7230 | 26 | 2.1 | \$307 | \$15 |
| 56 $\frac{3}{8}$ "W x $\frac{3}{4}$ "D x 10"H — For 60" x 30" Desks | HLAMMP6030 | 23 | 1.8 | \$280 | \$15 |

NOTES: For use with 60"W or 72"W worksurfaces supported by O-legs. Comprised of three panels: one approach side and one for each end. Length below bottom of worksurface is 10". Steel external support channel (ordered separately) is recommended for unsupported spans greater than 54"W (i.e.: a distance in which there is not a vertical support between the underside of the worksurface and floor). Grain direction is vertical on approach and side panels for 56 $\frac{3}{8}$ "W (all laminate colors) and 68 $\frac{3}{8}$ "W (L1 laminate except Florence Walnut and Kingswood Walnut). Vertical on 27 $\frac{5}{8}$ " end panels (all laminate colors). Horizontal on all panels for L2 laminates as well as Florence Walnut and Kingswood Walnut.

Specify: Model.Laminate

SPECIFYING EXAMPLE: HLAMMP7230.N

! \$15 upcharge for L2 laminates. See pages 266-267 for laminate options.

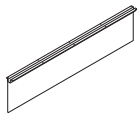

| DESCRIPTION | MODEL | SHIP WEIGHT | CUBE | L1 LIST PRICE | L2 UPCHARGE |
|--|------------------|-------------|------|---------------|-------------|
| Laminate Floating Modesty Panel | | | | | |
| 60"W x 14"H | HLSL6014L | 20 | 1.1 | \$277 | \$12 |
| 54"W x 14"H | HLSL5414L | 18 | 1.1 | \$258 | \$12 |
| 48"W x 14"H | HLSL4814L | 16 | 1.1 | \$236 | \$12 |
| 42"W x 14"H | HLSL4214L | 14 | 0.8 | \$214 | \$10 |
| 36"W x 14"H | HLSL3614L | 12 | 0.8 | \$202 | \$10 |
| 30"W x 14"H | HLSL3014L | 10 | 0.8 | \$191 | \$10 |

NOTES: The attachment bracket and modesty panel are packaged separately.

Specify: Model.Laminate.Paint

SPECIFYING EXAMPLE: HLSL3014L.N.P (Black is the only paint option for this model)

! When specifying the 54"W or 60"W Laminate Floating Modesty Panel, it is not necessary to specify an external support channel.

! 30"W and 36"W screens attach with L-brackets, not the external channel.

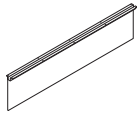

| DESCRIPTION | MODEL | SHIP WEIGHT | CUBE | L1 LIST PRICE | L2 UPCHARGE |
|--|---------------------|-------------|------|---------------|-------------|
| Mixed Material Floating Modesty Panel | | | | | |
| 60"W x 14"H | HLSL6014MM ☺ | 13 | 3.3 | \$1243 | N/A |
| 54"W x 14"H | HLSL5414MM ☺ | 13 | 3.3 | \$1089 | N/A |
| 48"W x 14"H | HLSL4814MM ☺ | 11 | 2.6 | \$1002 | N/A |
| 42"W x 14"H | HLSL4214MM ☺ | 9 | 2.3 | \$906 | N/A |
| 36"W x 14"H | HLSL3614MM | 8 | 2.0 | \$810 | N/A |
| 30"W x 14"H | HLSL3014MM | 8 | 2.0 | \$755 | N/A |

NOTES: The attachment bracket and modesty panel are packaged separately.

Specify: Model.Mixed Material.Paint

SPECIFYING EXAMPLE: HLSL3014MM.FT01.P (Frosted Translucent mixed material and Black paint are the only options for this model)

! When specifying the 54"W or 60"W Mixed Material Floating Modesty Panel, it is not necessary to specify an external support channel.

NOTES:

- Floating panel options attach under worksurfaces and are available in laminate or mixed (frosted translucent) material. The modesty panel and attachment bracket are packaged separately.
- If using a 54"W or 60"W floating modesty panel, it is not necessary to specify an external support channel.
- When using a floating modesty panel under the worksurface, the depth clearance for center drawers and keyboard platforms decreases by 8".
- The full width/half-height and full-to-floor/full-height panels are filler options designed only for use on 60", 66", and 72"W x 29 $\frac{1}{2}$ "H, double, 15 $\frac{3}{4}$ "W, pedestal desks and credenzas that are specified/built with modular components.

HOW TO SPECIFY

| | |
|--|--|
| Select Model Number HLSL3014MM | Select Mixed Material FT01 Frosted Translucent |
|--|--|

CONCINNITY™

Components — Modesty/Back Panels

GSA SIN 33721

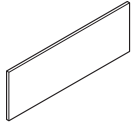

Icon Legend on page 19

**DESCRIPTION****MODEL****SHIP WEIGHT****CUBE****L1 LIST PRICE****L2 UPCHARGE****Full Width/Half-Height Laminate Modesty Panel**

40"W x 14"H, for use with 72" desks

HLSL4014LM

29

2.4

\$224**\$10**

34"W x 14"H, for use with 66" desks

HLSL3414LM

23

1.9

\$215**\$10**

28"W x 14"H, for use with 60" desks

HLSL2814LM

19

1.6

\$208**\$10**

NOTES: Filler piece that can only be used between the following supports: two 15¾"W modular pedestals, two 15¾"W L-shaped end panels, or one 15¾"W modular pedestal and one 15¾"W L-shaped end panel. Attachment brackets included.

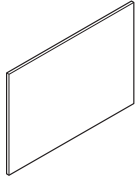
**Full-to-Floor/Full-Length Laminate Modesty Panel**

40"W x 28½"H, for use with 72" desks

HLSL4028LM

44

3.6

\$343**\$12**

34"W x 28½"H, for use with 66" desks

HLSL3428LM

38

3.2

\$326**\$12**

28"W x 28½"H, for use with 60" desks

HLSL2828LM

33

2.7

\$277**\$12**

NOTES: Filler piece that can only be used between the following supports: two 15¾"W modular pedestals, two 15¾"W L-shaped end panels, or one 15¾"W modular pedestal and one 15¾"W L-shaped end panel. Attachment brackets included.

NOTES:

- Floating panel options attach under worksurfaces and are available in laminate or mixed (frosted translucent) material. The modesty panel and attachment bracket are packaged separately.
- If using a 54"W or 60"W floating modesty panel, it is not necessary to specify an external support channel.
- When using a floating modesty panel under the worksurface, the depth clearance for center drawers and keyboard platforms decreases by 8".
- The full width/half-height and full-to-floor/full-height panels are filler options designed only for use on 60", 66", and 72"W x 29½"H, double, 15¾"W, pedestal desks and credenzas that are specified/built with modular components.

HOW TO SPECIFY
Select Model Number

Select Laminate Color

See page 29

CONCINNITY™ MODESTY/BACK PANELS

| HNL Floating Modesty Panel — HSLx14L/MM — Selection Guide | | | | | | | | | | | | | | |
|---|---|--------------|-------------------|-----|-----|-----|-----|-----|-----|-----|-----|-----|-----|-----|
| | Support Combination | | Worksurface Width | | | | | | | | | | | |
| | Support 1 | Support 2 | 30" | 36" | 42" | 48" | 54" | 60" | 66" | 72" | 78" | 84" | 90" | 96" |
| O-LEG ON ONE END | O-Leg | O-Leg | NA | NA | 36 | 42 | 48 | 54 | 60 | 60 | 60 | NA | NA | NA |
| | O-Leg | 9½"W Ped | NA | NA | NA | 30 | 36 | 42 | 48 | 54 | 60 | 60 | NA | NA |
| | O-Leg | End Bookcase | NA | NA | NA | 30 | 36 | 42 | 48 | 54 | 60 | 60 | 60 | NA |
| | O-Leg | L End Panel | NA | NA | NA | 36 | 42 | 48 | 54 | 60 | 60 | 60 | NA | NA |
| | O-Leg | 15¾"W Ped | NA | NA | NA | NA | 30 | 36 | 42 | 48 | 54 | 60 | 60 | NA |
| | O-Leg | 18"W Ped | NA | NA | NA | NA | 30 | 36 | 42 | 48 | 54 | 60 | 60 | 60 |
| | O-Leg | 30"W Ped | NA | NA | NA | NA | NA | NA | 30 | 36 | 42 | 48 | 54 | 60 |
| | O-Leg | 36"W Ped | NA | NA | NA | NA | NA | NA | NA | 30 | 36 | 42 | 48 | 54 |
| NARROW PED | 9½"W Ped | 9½"W Ped | NA | NA | NA | NA | 30 | 36 | 42 | 48 | 54 | 60 | 60 | 60 |
| | 9½"W Ped | End Bookcase | NA | NA | NA | NA | 30 | 36 | 42 | 48 | 54 | 60 | 60 | 60 |
| | 9½"W Ped | L End Panel | NA | NA | NA | NA | 30 | 36 | 42 | 48 | 54 | 60 | 60 | NA |
| | 9½"W Ped | 15¾"W Ped | NA | NA | NA | NA | NA | 30 | 36 | 42 | 48 | 54 | 60 | 60 |
| | 9½"W Ped | 18"W Ped | NA | NA | NA | NA | NA | 30 | 36 | 42 | 48 | 54 | 60 | 60 |
| | 9½"W Ped | 30"W Ped | NA | NA | NA | NA | NA | NA | NA | NA | 30 | 36 | 48 | 48 |
| | 9½"W Ped | 36"W Ped | NA | NA | NA | NA | NA | NA | NA | NA | 30 | 36 | 42 | 48 |
| END BOOKCASE PED | End Bookcase | End Bookcase | NA | NA | NA | NA | NA | 30 | 36 | 42 | 48 | 54 | 60 | 60 |
| | End Bookcase | L End Panel | NA | NA | NA | NA | 30 | 36 | 36 | 48 | 54 | 60 | 60 | 60 |
| | End Bookcase | 15¾"W Ped | NA | NA | NA | NA | NA | 30 | 36 | 42 | 48 | 54 | 60 | 60 |
| | End Bookcase | 18"W Ped | NA | NA | NA | NA | NA | NA | 30 | 36 | 42 | 48 | 54 | 60 |
| | End Bookcase | 30"W Ped | NA | NA | NA | NA | NA | NA | NA | NA | 30 | 36 | 42 | 48 |
| | End Bookcase | 36"W Ped | NA | NA | NA | NA | NA | NA | NA | NA | NA | 30 | 36 | 42 |
| L END PANEL | L End Panel | L End Panel | NA | NA | NA | NA | 36 | 36 | 48 | 54 | 60 | 60 | 60 | NA |
| | L End Panel | 15¾"W Ped | NA | NA | NA | NA | NA | 30 | 36 | 42 | 48 | 54 | 60 | 60 |
| | L End Panel | 18"W Ped | NA | NA | NA | NA | NA | 30 | 36 | 42 | 48 | 54 | 60 | 60 |
| | L End Panel | 30"W Ped | NA | NA | NA | NA | NA | NA | NA | 30 | 36 | 42 | 48 | 54 |
| | L End Panel | 36"W Ped | NA | NA | NA | NA | NA | NA | NA | NA | 30 | 36 | 42 | 48 |
| TWO PEDS | 15¾"W Ped | 15¾"W Ped | NA | NA | NA | NA | NA | NA | 30 | 36 | 42 | 48 | 54 | 60 |
| | 15¾"W Ped | 18"W Ped | NA | NA | NA | NA | NA | NA | 30 | 36 | 36 | 48 | 54 | 60 |
| | 15¾"W Ped | 30"W Ped | NA | NA | NA | NA | NA | NA | NA | NA | 30 | 36 | 42 | 48 |
| | 15¾"W Ped | 36"W Ped | NA | NA | NA | NA | NA | NA | NA | NA | 30 | 36 | 42 | 48 |
| | 18"W Ped | 18"W Ped | NA | NA | NA | NA | NA | NA | NA | 30 | 36 | 42 | 48 | 54 |
| | 18"W Ped | 30"W Ped | NA | NA | NA | NA | NA | NA | NA | NA | NA | 30 | 36 | 42 |
| | 18"W Ped | 36"W Ped | NA | NA | NA | NA | NA | NA | NA | NA | NA | NA | 30 | 36 |
| | 30"W Ped | 30"W Ped | NA | NA | NA | NA | NA | NA | NA | NA | NA | NA | NA | 30 |
| | 30"W Ped | 36"W Ped | NA | NA | NA | NA | NA | NA | NA | NA | NA | NA | NA | NA |
| | 36"W Ped | 36"W Ped | NA | NA | NA | NA | NA | NA | NA | NA | NA | NA | NA | NA |
| HT ADJ BASE | Height Adjustable Electric Base (models HHATB3S2LT/C) | | NA | NA | NA | 42 | 48 | 54 | 60 | 60 | NA | NA | NA | NA |
| PENINSULA | Support Column | T End Panel | NA | NA | NA | 30 | 30 | 36 | 42 | 48 | 54 | 60 | 60 | 60 |
| | Support Column | 9½"W Ped | NA | NA | NA | NA | NA | 30 | 36 | 42 | 48 | 54 | 60 | 60 |
| | Support Column | 15¾"W Ped | NA | NA | NA | NA | NA | NA | 30 | 36 | 42 | 48 | 54 | 60 |
| | Support Column | 18"W Ped | NA | NA | NA | NA | NA | NA | 30 | 36 | 42 | 48 | 54 | 60 |
| | Support Column | 30"W Ped | NA | NA | NA | NA | NA | NA | NA | NA | 30 | 36 | 42 | 48 |
| | Support Column | 36"W Ped | NA | NA | NA | NA | NA | NA | NA | NA | NA | 30 | 36 | 42 |
| RETURN CONFIGURATION | None | O-Leg | NA | NA | 36 | 42 | 48 | 54 | 60 | 60 | 60 | NA | NA | NA |
| | None | 9½"W Ped | NA | NA | NA | 30 | 36 | 42 | 48 | 54 | 60 | 60 | NA | NA |
| | None | End Bookcase | NA | NA | NA | 30 | 36 | 42 | 48 | 54 | 60 | 60 | 60 | NA |
| | None | L End Panel | NA | NA | 36 | 36 | 42 | 48 | 54 | 60 | 60 | 60 | NA | NA |
| | None | 15¾"W Ped | NA | NA | NA | NA | 30 | 36 | 42 | 48 | 54 | 60 | 60 | NA |
| | None | 18"W Ped | NA | NA | NA | NA | 30 | 36 | 42 | 48 | 54 | 60 | 60 | 60 |
| | None | 30"W Ped | NA | NA | NA | NA | NA | NA | 30 | 36 | 42 | 48 | 54 | 60 |
| | None | 36"W Ped | NA | NA | NA | NA | NA | NA | NA | 30 | 36 | 42 | 48 | 60 |

NA = Floating Modesty Panel not applicable for use with worksurface width and support combination

CONCINNITY™

Components — Supports

GSA SIN 33721

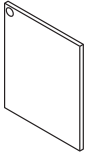
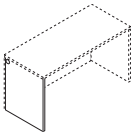
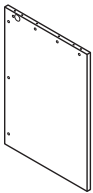
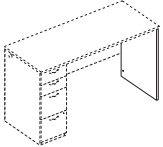

Icon Legend on page 19

| | DESCRIPTION | MODEL | SHIP WEIGHT | CUBE | L1 LIST PRICE | L2 UPCHARGE |
|---|---|--|-------------|------------|------------------------------|----------------------------|
|  HNLEP3628R shown | 1 1/8" Laminate End Panels — For 29 1/2"H | | | | | |
| | 1 1/8"W x 35"D x 28 1/2"H for 36"D, Right 1 1/8"W x 35"D x 28 1/2"H for 36"D, Left | HNLEP3628R HNLEP3628L | 39 39 | 2.8 2.8 | \$286 \$286 | \$20 \$20 |
|  HNLEP3028R shown | 1 1/8"W x 29 1/8"D x 28 1/2"H for 30"D, Right 1 1/8"W x 29 1/8"D x 28 1/2"H for 30"D, Left | HNLEP3028R HNLEP3028L | 32 32 | 2.3 2.3 | \$252 \$252 | \$15 \$15 |
| | 1 1/8"W x 23 1/8"D x 28 1/2"H for 24"D, Right 1 1/8"W x 23 1/8"D x 28 1/2"H for 24"D, Left | HNLEP2428R HNLEP2428L | 22 22 | 1.9 1.9 | \$224 \$224 | \$10 \$10 |
|  HNLEP4241R shown | 1 1/8" Laminate End Panels — For 42"H | | | | | |
| | 1 1/8"W x 29 1/8"D x 41"H for 30"D, Right 1 1/8"W x 29 1/8"D x 41"H for 30"D, Left | HNLEP3041R HNLEP3041L | 47 47 | 3.2 3.2 | \$284 \$284 | \$20 \$20 |
|  HNLEP2441R shown | 1 1/8"W x 23 1/8"D x 41"H for 24"D, Right 1 1/8"W x 23 1/8"D x 41"H for 24"D, Left | HNLEP2441R HNLEP2441L | 37 37 | 2.6 2.6 | \$267 \$267 | \$15 \$15 |

NOTES: Supports the end of a component worksurface where there is no modular pedestal. 1 1/8" Laminate End Panels must be used with a full-length (27 7/8"H) or short (10"H) modesty/back panel; ordered separately, see page 84. The depth of an end panel is 3/4" less than the depth of the worksurface, to accommodate the modesty/back panel. Handed design (left and right models). Bottom of end panel is edgebanded for added strength and to seal out moisture. Applications include — For the non-pedestal end of single pedestal desks or credenzas utilizing modular storage components. For returns that do not have a modular storage pedestal to support the worksurface. For extended corner units that do not utilize a 15 3/4"W x 23 1/8"D modular storage pedestal to support the 24"D worksurface dimension. For building desk or credenza shells comprised of a worksurface top and modesty/back panel components, and left and right end panel. Available in a woodgrain or solid laminate color only. Can be specified with or without grommet; see chart on page 34 for cord management options. If grommet option is chosen, the color is black only.

NOTES:

❗ 1 1/8" Laminate End Panels must be used with a full-length (27 7/8"H) or short (10"H) modesty/back panel; ordered separately, see page 84.

HOW TO SPECIFY

| | | |
|---|---|--|
| Select Model Number <input type="text" value="HNLEP2428R"/> | Select Grommet <input type="checkbox"/> Black <input checked="" type="checkbox"/> No Grommet | Select Laminate Color <input type="text" value="H"/> See page 29 |
|---|---|--|

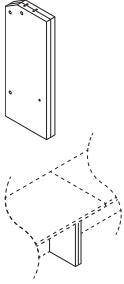

| DESCRIPTION | MODEL | SHIP WEIGHT | CUBE | L1 | L2 |
|---|------------------|-------------|------|--------------|-------------|
| | | | | LIST PRICE | UPCHARGE |
| Kneespace Clearance End Panels 1 1/8"W x 11 1/4"D x 41"H for 24"D, 2 pk | HNLEP1141 | 25 | 2.8 | \$314 | \$10 |
| 1 1/8"W x 11 1/4"D x 28 1/2"H for 24"D, 2 pk | HNLEP1128 | 25 | 2.0 | \$256 | \$10 |

NOTES: Creates additional kneespace for the user. Two 1 1/8"W x 11 1/4"D laminate end panels, one left, one right; sized to support two adjoining, contiguous 24"D worksurfaces. Can be specified with worksurfaces at time of installation or ordered as replacement for two side-by-side 1 1/8"W x 23"D end panels. Available in 28 1/2" and 41"H. Can be used to connect up to three credenzas in line (2 kits). Not designed for use with returns. Allows conversion of units currently in the field; European fasteners make installation quick and easy. Cord routing notch in top back of each panel. Includes two 1 1/8" thick panels; European fastening hardware; flat connector bracket; self-tapping wood screws for ganging credenza to adjacent worksurface; and adjustable leveling glides. Can be specified in a woodgrain or solid laminate color only; not in a two-tone combination.

SPECIFYING EXAMPLE: HNLEP1128.H

HOW TO SPECIFY

| | |
|--|---|
| <p>Select Model Number</p> <p>HNLEP1128</p> | <p>Select Grommet</p> <p>P Black X No Grommet</p> <p>X</p> |
|--|---|

CONCINNITY™

Components — Supports

GSA SIN 33721



Icon Legend on page 19

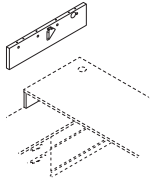

HNLEP307L shown

| DESCRIPTION | MODEL | SHIP WEIGHT | CUBE | L1 LIST PRICE | L2 UPCHARGE |
|---|------------------|-------------|------|---------------|-------------|
| Laminate End Panel — 7" H Support for Worksurfaces | | | | | |
| 1½"W x 30"D x 7"H, Right | HNLEP307R | 7 | 0.7 | \$147 | \$10 |
| 1½"W x 30"D x 7"H, Left | HNLEP307L | 7 | 0.7 | \$147 | \$10 |
| 1½"W x 24"D x 7"H, Right | HNLEP247R | 6 | 0.7 | \$147 | \$10 |
| 1½"W x 24"D x 7"H, Left | HNLEP247L | 6 | 0.7 | \$147 | \$10 |

NOTES: Specifically for layered surface applications; used to support a 29½"H component worksurface over a 21½"H low credenza unit. 1½" thick. Handed design (left and right models). Includes cord routing notch. Bottom of end panel is edgebanded for added strength and to seal out moisture. Attaches to underside of worksurface via cam fasteners and L-bracket; attaches to top of low credenza with double-sided tape. Can be specified in a woodgrain or solid laminate color only. For 7"H metal O-leg support see page 92.

SPECIFYING EXAMPLE: HNLEP307R.H

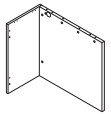

HNLLEP3028R shown

| DESCRIPTION | MODEL | SHIP WEIGHT | CUBE | L1 LIST PRICE | L2 UPCHARGE |
|--|--------------------|-------------|------|---------------|-------------|
| Laminate L-Shaped End Panels — For 29½" H | | | | | |
| 15¾"W x 30"D x 28½"H, Right | HNLLEP3028R | 38 | 4.3 | \$404 | \$15 |
| 15¾"W x 30"D x 28½"H, Left | HNLLEP3028L | 38 | 4.3 | \$404 | \$15 |
| 15¾"W x 24"D x 28½"H, Right | HNLLEP2428R | 32 | 2.8 | \$364 | \$15 |
| 15¾"W x 24"D x 28½"H, Left | HNLLEP2428L | 32 | 2.8 | \$364 | \$15 |

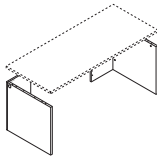

HNLLEP3028R and HNLLEP3028L shown

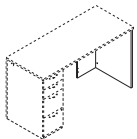
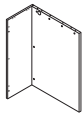

HNLLEP3041R shown



| DESCRIPTION | MODEL | SHIP WEIGHT | CUBE | L1 LIST PRICE | L2 UPCHARGE |
|---|--------------------|-------------|------|---------------|-------------|
| Laminate L-Shaped End Panels — For 42" H | | | | | |
| 15¾"W x 30"D x 41"H, Right | HNLLEP3041R | 55 | 4.3 | \$447 | \$20 |
| 15¾"W x 30"D x 41"H, Left | HNLLEP3041L | 55 | 4.3 | \$447 | \$20 |
| 15¾"W x 24"D x 41"H, Right | HNLLEP2441R | 47 | 2.8 | \$400 | \$20 |
| 15¾"W x 24"D x 41"H, Left | HNLLEP2441L | 47 | 2.8 | \$400 | \$20 |

NOTES: Supports the end of a component worksurface where there is no modular pedestal. Provides easy, open access to wall electrical outlets. For configurations requiring a modesty panel, options include a laminate floating modesty panel or a mixed material floating modesty panel — see page 85. Tops and bottoms of panels are edgebanded. Two pieces; 1½" end panel and ¾" back panel. Ships simple assembly. Can be specified in a woodgrain or solid laminate color only; not available in a two-tone combination. See chart on page 34 for cord management options. If grommet option is chosen for the end panel, the color is black only.

SPECIFYING EXAMPLE: HNLLEP2428R.X.H

HOW TO SPECIFY

Select
Model Number

H N L E P 3 0 7 R .

Select
Laminate Color

See page 29

H

Select
Model Number

H N L L E P 3 0 2 8 R .

Select
Grommet

P Black
X No Grommet

X

Select
Laminate Color

See page 29

H



CONCINNITY™ Components — Supports

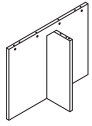

DESCRIPTION

MODEL

SHIP WEIGHT

CUBE

**L1
LIST PRICE**

**L2
UPCHARGE**

Laminate T-Shaped End Panels — For 29½”H

11⅝”W x 35⅞”D x 28½”H

HNLTEP3628

45

3.7

\$413

\$20

11⅝”W x 29⅞”D x 28½”H

HNLTEP3028

39

3.3

\$386

\$20

11⅝”W x 23⅞”D x 28½”H

HNLTEP2428

33

2.9

\$364

\$20

NOTES: Supports the end of a component worksurface where there is no modular pedestal. Available in 24”, 30”, and 36”D x 28½”H. Two 1⅝” thick pieces; one end and one brace panel. Cord routing notch in brace panel. Non-handed. Ships ; simple assembly. Can be specified in a woodgrain or solid laminate color only; not available in a two-tone combination.

SPECIFYING EXAMPLE: HNLTEP3628.H

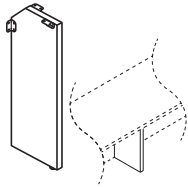

Support Brace — For 29½”H

1⅝”W x 10½”D x 28½”H

HNL11SUPP

11

0.9

\$164

\$10

NOTES: Minimizes worksurface deflection by providing added internal support under 24”D tops with an unsupported span of 54” or wider (distance for which there is no panel, leg, or pedestal support component). Not for use as an end panel. 11”D size provides kneespace clearance. Attaches with brackets to both the underside of the worksurface top and either a conventional full-length or 10” laminate modesty panel; not for use with O-leg or L-shaped end panel supports. 1⅝” thick. Cord routing notch in brace panel. Can be specified in a woodgrain or solid laminate color only.

SPECIFYING EXAMPLE: HNL11SUPP.H

HOW TO SPECIFY

Select Model Number

H N L 1 1 S U P P . H

Select Laminate Color

See page 29

H

CONCINNITY™

Components — Supports

GSA SIN 33721

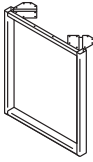
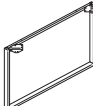
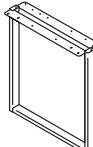
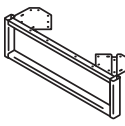
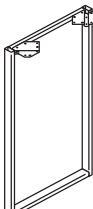
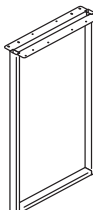

Icon Legend on page 19

| | DESCRIPTION | MODEL | SHIP WEIGHT | CUBE | LIST PRICE BY PAINT GRADE | | |
|--|--|--|-------------|------------|------------------------------|------------------------------|------------------------------|
| | | | | | P1 | P2 | P3 |
|  | O-Leg 30"D x 28½"H 24"D x 28½"H | HLSL30280 ⓘ HLSL24280 | 19 17 | 5.4 3.7 | \$395 \$357 | \$399 \$361 | \$415 \$377 |
| | NOTES: Ship fully assembled, 1/pack. Non-handed. IMPORTANT: The O-leg attachment bracket interferes with placement of 28¾"H mobile pedestals, preventing them from being positioned directly next to (flush with) the O-leg. Box/file mobile pedestal (model HNL2116MBF) can be positioned along side the O-leg. SPECIFYING EXAMPLE: HLSL24280.T1 | | | | | | |
|  | Double-Depth O-Leg Support for Worksurfaces 60"D x 28½"H 48"D x 28½"H | HLSL60280 HLSL48280 | 19 18 | 8.7 7.0 | \$746 \$670 | \$754 \$678 | \$766 \$690 |
| | NOTES: Ship fully assembled, 1/pack. Non-handed. 48"D and 60"D sizes span back-to-back 24"D and 30"D worksurfaces, respectively. | | | | | | |
|  | O-Leg Shared Support for Worksurfaces 30"D x 28½"H 24"D x 28½"H | HLSL3028SL ⓘ HLSL2428SL | 19 17 | 5.4 3.7 | \$491 \$443 | \$495 \$447 | \$511 \$463 |
| | NOTES: Ship fully assembled, 1/pack. Non-handed. ⓘ Specify paint only. SPECIFYING EXAMPLE: HLSL2028SL.T1 | | | | | | |
|  | O-Leg Support for Low Credenzas 30"D x 7"H 24"D x 7"H | HLSL3070 ⓘ HLSL2470 | 7 6 | 1.0 1.0 | \$305 \$240 | \$309 \$244 | \$325 \$260 |
| | NOTES: Ship fully assembled, 1/pack. Non-handed. For 7"H laminate support see page 90. ⓘ Specify paint only. SPECIFYING EXAMPLE: HLSL2070.T1 | | | | | | |
|  | Standing-Height O-Leg Support for Worksurfaces 30"D x 41"H 24"D x 41"H | HLSL30410 HLSL24410 | 17 16 | 6.5 5.3 | \$533 \$476 | \$539 \$482 | \$553 \$496 |
| | NOTES: Ship fully assembled, 1/pack. Non-handed. | | | | | | |
|  | Standing-Height O-Leg Shared Support for Worksurfaces 30"D x 41"H 24"D x 41"H | HLSL3041SL HLSL2441SL | 17 16 | 6.5 5.3 | \$593 \$537 | \$599 \$543 | \$613 \$557 |
| | NOTES: Ship fully assembled, 1/pack. Non-handed. For use with two 24"D or 30"D worksurfaces positioned side-by-side along the depth dimension. | | | | | | |

NOTES:

- Open frame, metal design.
- O-leg ships fully assembled with mounting hardware.
- O-leg glides have 2" adjustability.
- Will have 6" overhang when using 30"D O-legs with a 36"D worksurface.
- Shared O-legs create a cleaner aesthetic in all applications where two legs are used side-by-side.

ⓘ O-legs may only be attached to worksurfaces, not storage units.

ⓘ O-leg installation requires 6" of clearance from the worksurface end.

ⓘ For use with worksurfaces up to 78"W. When using an 84"W or wider worksurface, cannot use two O-legs; must use one 15¾" or wider pedestal for the other support.

HOW TO SPECIFY

Select
Model Number



Select
Paint Color

See page 183

HLSL30280.T1

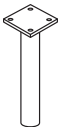

CONCINNITY™ Components — Supports

| | DESCRIPTION | MODEL | SHIP WEIGHT | CUBE | LIST PRICE |
|---|--|----------------|--|------|--------------|
|  | Support Column 3" Diameter. Specify: HPC190X.P. Black only. | HPC190X | 12  | 1.0 | \$173 |
| | Support Column 3" Diameter. Specify: HPC191X.X. Available in Silver only. | HPC191X | 12  | 1.0 | \$173 |
| | NOTES: For peninsula or island extension worksurface application. | | | | |

| | DESCRIPTION | MODEL | SHIP WEIGHT | CUBE | LIST PRICE BY PAINT GRADE | |
|---|--|----------------|-------------|------|---------------------------|--------------|
| | | | | | P1 | P2 |
|  | Post Leg Base 28½"H x 2" square | HLSL28P | 15 | 1.0 | \$321 | \$325 |
| | NOTES: Can only be used as the outbound support in a peninsula or island extension worksurface application. Glides have 2" of adjustability. Ship 1/pack. SPECIFYING EXAMPLE: HLSL28P.T1 | | | | | |

NOTES:



- All bases allow tops to sit at 29½" from the floor with glides half-way seated.

Height Adjustable Base

- 3-Stage column design.
- Frame rises from 23¾" to 49¼" for a sit-to-stand desk option.
- Ships complete with a pre-assembled motor.
- Base telescopes to accommodate any worksurface between 48"W and 72"W.
- Accommodates rectangular worksurfaces between 24"D x 48"W and 30"D x 72"W.
- Standard height adjustable control ships with base.
- Dynamic load capacity when worksurface is moving is 300 lbs.
- Optional Memory Control allows preset worksurface heights for consistency. Ships separately.
- Silver finish matches any neutral HON paint or finish color.
- Tops and bases are ordered and sold separately.

Post and T-Leg Bases

- Both glides and casters attach to the foot easily without tools for assembly.
- Bases specified with casters include two locking and two non-locking casters.
- Bases specified with glides have four adjustable glides, which adjust 1".
- When post legs are used with 18"W tops, post leg to be specified with glides only.

-  Support column must be specified for worksurfaces used as peninsulas or as an island extension.
-  Post leg can only be used to support peninsula, not as primary supports for a top.

HOW TO SPECIFY

| | |
|--|---|
| <p>Select Model Number</p> <p>H P C 1 9 0 X .</p> | <p>Select Paint Color</p> <p>See page 183</p> <p>T 1</p> |
|--|---|

CONCINNITY™

Components — Supports

GSA SIN 33721

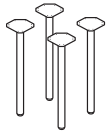

Icon Legend on page 19

**DESCRIPTION****Post Leg Base (Includes 4 Post Legs)**

24"D and 30"D Worksurfaces up to 72"W

MODEL**HMBPOST****SHIP WEIGHT**

18

CUBE

2.3

LIST PRICE**\$388**

NOTES: For 54" and 60" worksurfaces, use one external channel, centered between user and approach sides. For 66" and 72"W worksurfaces, use two external channels; if no grommets, locate the channels 3" from user and approach sides; if grommets are in the worksurface, locate channels 3" from user and 6" from approach sides.

1¾" diameter Post Leg Base with glide (HMBPOST.G); qty. 4; for 30" to 72"W x 24"D and 48" to 72"W x 30"D tops

1¾" diameter Post Leg Base with casters (HMBPOST.C); qty. 4; for 30" to 72"W x 24"D and 48" to 72"W x 30"D tops

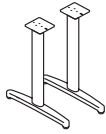
**Fixed Height T-Leg Base (Includes 2 T-legs)**

For 24"D and 30"D Worksurfaces up to 72"W

HMBTLEG24

14

3.6

\$459

NOTES: Use external channel when space between the two legs is 54"W or greater. Center the channel between approach and user sides. See model listing on page 82.

Fixed Height T-Leg Base with glide (HMBTLEG24.G); qty. 2; for 24" and 30"D tops up to 72"W; adjustable glides have 1" range

Fixed Height T-Leg Base with casters (HMBTLEG24.C); qty. 2; for 24" and 30"D tops up to 72"W; two locking and two non-locking casters

NOTES:

- All bases allow tops to sit at 29½" from the floor with glides half-way seated.

Post and T-Leg Bases

- Both glides and casters attach to the foot easily without tools for assembly.
- Bases specified with glides have four adjustable glides, which adjust 1".
- When post legs are used with 18"W tops, post leg to be specified with glides only.

ⓘ Support column must be specified for worksurfaces used as peninsulas or as an island extension.

ⓘ Post leg can only be used to support peninsula, not as primary supports for a top.

HOW TO SPECIFY**Select Model Number**

HMBTLEG24

Select Glide/Caster Option**G** Glide**C** Caster

18"D tops are not available in Concinnity™

G

Select Paint Color

See page 29

\$20 upcharge per model, for Metallic paint

T1



CONCINNITY™ Height Adjustable Bases

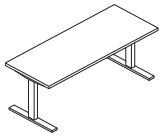

Base shown with work surface attached.

DESCRIPTION

Coordinate™ Height Adjustable Base – 2 Stage
2-Leg Rectangle T Foot

MODEL

HHATB2S2LT

SHIP WEIGHT

66

CUBE

2.4

LIST PRICE

\$950

NOTES:

- Dual motor two-leg design. Legs raise from 25½" to 45¼".
- Base accommodates any rectangular work surface between 23"D x 40"W and 30"D x 72"W.
- Weight capacity of 250 lbs. (excluding the weight of the work surface) distributed evenly.

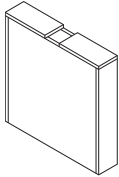

Not available in two-tone laminate.

SIN 33721

Shroud for Height Adjustable Base

5½"W x 26"D x 24¼"H for Base with 30"D Top

HLAMSHB30

39

3.7

\$899

NOTES: Decorative laminate enclosure covers the Coordinate™ metal leg and foot. For use with standard 10500 Series™, Concinnity™, and Voi® rectangle work surfaces, 42-72"W x 30"D, supported by Height Adjustable Base model HHATB2S2LT. For height adjustable desks requiring a modesty panel, options include: 14"H laminate (HLSLXX14L) or mixed material (HLSLXX14MM) floating modesty panels, laminate full length (HNLMPXX28) or short (HNLMPXX10) modesty/back panel plus external support channel (HLSLZ5SCXX). External support channel attachment screws and modesty/back panel cover caps are included in the shroud hardware pack. External support channel size recommendation, specific to work surface attached to Height Adjustable Base with optional laminate full-length or short modesty back/panel (HNLMPXX28/10) see below. Ships one per carton. To conceal both metal legs on the Height Adjustable Base order two. When using a modesty panel set height adjustable table at 29"H to ensure table stops before hitting shroud.

Specify: Model.Laminate; see pages 266-267.

SPECIFYING EXAMPLE: HLAMSHB30.N

- ! Lowest base adjustment position when the shroud is installed is 29½"H; memory controller must be set at that height to avoid interference.
- ! The Height Adjustable Base must be reset at the time of installation, after every loss of power, if the unit is not functioning properly, or if the legs are uneven. To reset the base requires removing the laminate shroud(s), as well as the full-length modesty panel if one is being used, then adjusting the base to its lowest position. Disassembly of the shroud is quick and easy.
- ! \$25 upcharge for L2 laminates.

| Work surface Width | Modesty/Back Panel Width | External Support Channel |
|--------------------|--------------------------|--------------------------|
| 72"W | 72"W | HLSLZ5SC78 |
| 66"W | 66"W | HLSLZ5SC72 |
| 60"W | 60"W | HLSLZ5SC66 |
| 54"W | 54"W | HLSLZ5SC60 |
| 48"W | 48"W | HLSLZ5SC54 |

NOTES:

Height Adjustable Base

- Control Box: 120V, 4A, 60Hz, 400W.
- 9' grounded power cord.
- 1½"/second travel speed.
- <50 dB noise rating.
- **HON 10-Year Warranty.**

! Requires the use of an external stiffener (purchased separately) for work surfaces over 60"W when not used with a Coordinate™ work surface.

HOW TO SPECIFY

| | | | |
|---|---|---|--|
| <p>Select Model Number</p> <p>HHATB2S2LT</p> | <p>Select Paint Color</p> <p>See page 116</p> <p>P71</p> | <p>Select Foot</p> <p>X Standard Foot S Slide Glide</p> <p>X</p> | <p>Select Keypad</p> <p>UD Basic Up/Down MEM Memory Preset PDL Paddle RTG Rotating (+ \$50) FPD Foot Pedal (+ \$175)</p> <p>MEM</p> |
|---|---|---|--|

CONCINNITY™

Components — Privacy Screens

GSA SIN 33721

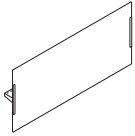

Icon Legend on page 19

**DESCRIPTION****Above/Below Privacy Screen**

60"W x 28"H
54"W x 28"H
48"W x 28"H
42"W x 28"H
36"W x 28"H
30"W x 28"H

MODEL

HLSL2860
HLSL2854
HLSL2848
HLSL2842
HLSL2836
HLSL2830

SHIP WEIGHT

9
9
8
6
6
6

CUBE

8.6
8.6
8.2
6.3
6.4
6.4

LIST PRICE

\$1565
\$1556
\$1336
\$1253
\$1240
\$896

NOTES: Attachment bracket extends 2" into top and underside of worksurface. Screen is frosted translucent acrylic. All brackets are platinum (no need to specify). Extends 13" above and 13" below worksurface.

❗ See page 97 for the "Above-Below Privacy Screen — HLSL28xx — Selection Guide".

❗ Available in Frosted Translucent Acrylic ONLY HLSL2830.FT01.

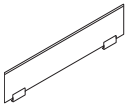
**Above Privacy Screen**

60"W x 13"H
54"W x 13"H
48"W x 13"H
42"W x 13"H
36"W x 13"H
30"W x 13"H

HLSL1260
HLSL1254
HLSL1248
HLSL1242
HLSL1236
HLSL1230

24
22
20
18
15
13

2.9
2.9
2.3
2.3
1.8
1.5

\$508
\$473
\$443
\$387
\$345
\$313

NOTES: Attachment requires 1" clear space/overhang on the underside of the worksurface. Screen is frosted glass. All brackets are platinum (no need to specify).

❗ Available in Frosted Glass ONLY HLSL1230.G.

❗ Above only privacy screen clamps onto worksurface and cannot be installed where support storage will be attached.

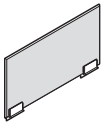
**Above Frosted Polymer (Side) Privacy Screen**

36"W x 13"H
30"W x 13"H
24"W x 13"H

HLSL1236FS
HLSL1230FS
HLSL1224FS

19 Ⓢ
16 Ⓢ
14 Ⓢ

1.9
1.6
1.4

\$447
\$399
\$369

NOTES: Attach to top and side of worksurface with adhesive banding. Platinum color brackets are intended to be attached between users sitting side-by-side. Brackets create a 1/8" separation between adjacent worksurfaces.

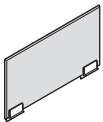
**Above Frosted Glass (Side) Privacy Screen**

36"W x 13"H
30"W x 13"H
24"W x 13"H

HLSL1236GS
HLSL1230GS
HLSL1224GS

20 Ⓢ
18 Ⓢ
16 Ⓢ

1.9
1.6
1.4

\$371
\$333
\$308

NOTES: Attach to top and side of worksurface with adhesive banding. Platinum color brackets are intended to be attached between users sitting side-by-side. Brackets create a 1/8" separation between adjacent worksurfaces.

NOTES:

- Ships complete with attachment brackets.
- All brackets are Platinum.
- Above Privacy Screen attaches to top of worksurface.
- Above and below privacy screen extends 13" above and 13" below the worksurface.
- ❗ Above screens must attach to edgeband and top of surface.
- ❗ Screens cannot be used with T-mold on series such as tables. Screens can only attach to edgeband. Surfaces must be cleaned prior to adhering the screen and must be left to cure for 24 hours without touching for best adhesion.

HOW TO SPECIFY**Select Model Number**

HLSL2830 .

HLSL1230 .

Select Mixed Material**FT01** Frosted Translucent Acrylic

Specified for Above/Below Privacy Screens only

G Frosted Glass

Specified for Above Privacy Screens only

FT01

G

Select Model Number

HLSL1224FS .

HLSL1224GS .

Select Mixed Material**FT01** Frosted Translucent Acrylic

Specified for Above Screen models HLSL1224FS-HLSL1236FS only

G Frosted Glass

Specified for Above Screen models HLSL1224GS-HLSL1236GS only

FT01

G

CONCINNITY™ PRIVACY SCREENS

HNL Above-Below Privacy Screen — HLSL28xx — Selection Guide

| | Support Combination | | Worksurface Width | | | | | | | | | | | |
|----------------------|--|--------------|-------------------|-----|-----|-----|-----|-----|-----|-----|-----|-----|-----|-----|
| | Support 1 | Support 2 | 30" | 36" | 42" | 48" | 54" | 60" | 66" | 72" | 78" | 84" | 90" | 96" |
| O-LEG ON ONE END | O-Leg | O-Leg | NA | 30 | 36 | 42 | 48 | 54 | 60 | 60 | 60 | NA | NA | NA |
| | O-Leg | 9½"W Ped | NA | NA | 30 | 36 | 42 | 48 | 54 | 60 | 60 | 60 | NA | NA |
| | O-Leg | End Bookcase | NA | NA | NA | 30 | 36 | 42 | 48 | 54 | 60 | 60 | 60 | NA |
| | O-Leg | L End Panel | NA | NA | NA | 36 | 42 | 48 | 54 | 60 | 60 | 60 | NA | NA |
| | O-Leg | 15¾"W Ped | NA | NA | NA | 30 | 36 | 42 | 48 | 54 | 60 | 60 | 60 | NA |
| | O-Leg | 18"W Ped | NA | NA | NA | NA | 30 | 36 | 42 | 48 | 54 | 60 | 60 | 60 |
| | O-Leg | 30"W Ped | NA | NA | NA | NA | NA | NA | 30 | 36 | 42 | 48 | 54 | 60 |
| | O-Leg | 36"W Ped | NA | NA | NA | NA | NA | NA | NA | 30 | 36 | 42 | 48 | 54 |
| NARROW PED | 9½"W Ped | 9½"W Ped | NA | NA | NA | NA | 30 | 36 | 42 | 48 | 54 | 60 | 60 | 60 |
| | 9½"W Ped | End Bookcase | NA | NA | NA | NA | 30 | 36 | 42 | 48 | 54 | 60 | 60 | 60 |
| | 9½"W Ped | L End Panel | NA | NA | NA | 30 | 36 | 42 | 48 | 48 | 60 | 60 | 60 | NA |
| | 9½"W Ped | 15¾"W Ped | NA | NA | NA | NA | NA | 30 | 36 | 42 | 48 | 54 | 60 | 60 |
| | 9½"W Ped | 18"W Ped | NA | NA | NA | NA | NA | 30 | 36 | 42 | 48 | 54 | 60 | 60 |
| | 9½"W Ped | 30"W Ped | NA | NA | NA | NA | NA | NA | NA | 30 | 36 | 42 | 48 | 54 |
| | 9½"W Ped | 36"W Ped | NA | NA | NA | NA | NA | NA | NA | NA | 30 | 36 | 42 | 48 |
| END BOOKCASE PED | End Bookcase | End Bookcase | NA | NA | NA | NA | 30 | 36 | 42 | 48 | 54 | 60 | 60 | 60 |
| | End Bookcase | L End Panel | NA | NA | NA | NA | 30 | 36 | 42 | 48 | 54 | 60 | 60 | 60 |
| | End Bookcase | 15¾"W Ped | NA | NA | NA | NA | NA | 30 | 36 | 42 | 48 | 54 | 60 | 60 |
| | End Bookcase | 18"W Ped | NA | NA | NA | NA | NA | 30 | 36 | 42 | 48 | 54 | 60 | 60 |
| | End Bookcase | 30"W Ped | NA | NA | NA | NA | NA | NA | NA | 30 | 36 | 42 | 48 | 54 |
| | End Bookcase | 36"W Ped | NA | NA | NA | NA | NA | NA | NA | NA | 30 | 36 | 42 | 48 |
| L END PANEL | L End Panel | L End Panel | NA | NA | NA | 30 | 36 | 42 | 48 | 54 | 60 | 60 | 60 | NA |
| | L End Panel | 15¾"W Ped | NA | NA | NA | NA | 30 | 36 | 42 | 48 | 54 | 60 | 60 | 60 |
| | L End Panel | 18"W Ped | NA | NA | NA | NA | NA | 30 | 36 | 42 | 48 | 54 | 60 | 60 |
| | L End Panel | 30"W Ped | NA | NA | NA | NA | NA | NA | NA | 30 | 36 | 42 | 48 | 54 |
| | L End Panel | 36"W Ped | NA | NA | NA | NA | NA | NA | NA | NA | 30 | 36 | 42 | 48 |
| TWO PEDS | 15¾"W Ped | 15¾"W Ped | NA | NA | NA | NA | NA | NA | 30 | 36 | 42 | 48 | 54 | 60 |
| | 15¾"W Ped | 18"W Ped | NA | NA | NA | NA | NA | NA | 30 | 36 | 42 | 48 | 54 | 60 |
| | 15¾"W Ped | 30"W Ped | NA | NA | NA | NA | NA | NA | NA | NA | 30 | 36 | 42 | 48 |
| | 15¾"W Ped | 36"W Ped | NA | NA | NA | NA | NA | NA | NA | NA | NA | 30 | 36 | 42 |
| | 18"W Ped | 18"W Ped | NA | NA | NA | NA | NA | NA | 30 | 36 | 42 | 48 | 48 | 60 |
| | 18"W Ped | 30"W Ped | NA | NA | NA | NA | NA | NA | NA | NA | 30 | 36 | 42 | 48 |
| | 18"W Ped | 36"W Ped | NA | NA | NA | NA | NA | NA | NA | NA | NA | 30 | 36 | 42 |
| | 30"W Ped | 30"W Ped | NA | NA | NA | NA | NA | NA | NA | NA | NA | NA | 30 | 36 |
| | 30"W Ped | 36"W Ped | NA | NA | NA | NA | NA | NA | NA | NA | NA | NA | NA | 30 |
| | 36"W Ped | 36"W Ped | NA | NA | NA | NA | NA | NA | NA | NA | NA | NA | NA | NA |
| HT ADJ BASE | Height Adjustable Base (models HHATB3S2LT/C) | | NA | NA | NA | 42 | 48 | 54 | 60 | 60 | NA | NA | NA | NA |
| RETURN CONFIGURATION | None | O-Leg | NA | 30 | 36 | 42 | 48 | 54 | 60 | 60 | 60 | NA | NA | NA |
| | None | 9½"W Ped | NA | NA | 30 | 36 | 42 | 48 | 54 | 60 | 60 | 60 | NA | NA |
| | None | End Bookcase | NA | NA | NA | 30 | 36 | 42 | 48 | 54 | 60 | 60 | 60 | NA |
| | None | L End Panel | NA | NA | 30 | 36 | 42 | 48 | 54 | 60 | 60 | 60 | NA | NA |
| | None | 15¾"W Ped | NA | NA | NA | 30 | 36 | 36 | 48 | 54 | 60 | 60 | 60 | NA |
| | None | 18"W Ped | NA | NA | NA | NA | 30 | 36 | 42 | 48 | 54 | 60 | 60 | 60 |
| | None | 30"W Ped | NA | NA | NA | NA | NA | NA | 30 | 36 | 42 | 48 | 54 | 60 |
| | None | 36"W Ped | NA | NA | NA | NA | NA | NA | NA | 30 | 36 | 42 | 48 | 54 |

NA = Above-Below Screen not applicable for use with worksurface width and support combination

CONCINNITY™ COMPONENTS — SUPPORTS

SUPPORT STORAGE PEDESTALS — 28½”H

- Non-handed, interchangeable design reconfigures easily.
- For use with component top and modesty/back panels or pedestal top and back panels.
 - Pedestals are not fully enclosed and require a component top/worksurface and modesty/back panel or a pedestal back, both of which must be ordered separately.
 - Pedestal’s front and side panels are finished.
- The pedestal depth dimension is less than the like-size depth of the component top, to accommodate addition of a modesty/back panel.
 - 29½”D pedestals can be used under 30” or 36”D worksurfaces; 23½”D pedestals can be used under 24” or 30”D worksurfaces.
 - When specifying a 29½”D pedestal with ¾” modesty panel under a 36”D worksurface, or a 23½”D pedestal with a ¾” modesty panel under a 30”D worksurface, there will be a 6” approach side overhang.
- Bottom of side panels are edgebanded for added strength and to seal out moisture.
- Drawers:
 - Operate on steel ball-bearing suspensions to ensure smooth, quiet, long-lasting operation; full extension allows easy access to contents.
 - Fronts are edgebanded on all four sides.
 - Feature 5-sided construction for added strength and easy alignment or replacement of drawer fronts.

- Interchangeable core removable locks are located on front of all modular storage products, except the storage cabinet.
- Finish of lock is determined by, and aligned with, the handle finish specified.
- Locks feature a removable cylinder that can be interchanged as needed; allows users to access all furniture pieces in an office with a single key for convenience and security. Makes re-keying quick and easy. Keyed alike cores must be ordered separately by specification of the key number (removable lock core kit models available in Black [model HF23B] or Satin [model HF23S]).
- Ship fully assembled.
- Chassis and drawer front colors are specified separately; can be selected with common woodgrain or solid laminate color, or with different, complementary chassis and drawer/door colors.
- See chart on page 34 for cord management options. If the pedestal grommet option is chosen, two cutouts, one per end/side panel, each with a black plastic cap, are included.

SUPPORT STORAGE PEDESTALS — 41”H STANDING-HEIGHT

- Same as above except — not to be used freestanding; top and back are not enclosed.
 - Rear of pedestal can be enclosed with a full, 40¾”H back panel or with a 27⅞”H modesty panel combined with a lower, 13”H pedestal back component. Pedestal back and modesty panel must be ordered separately.



CONCINNITY™

Components — Supports

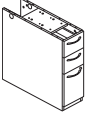
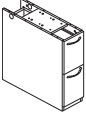
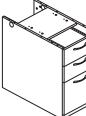
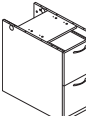
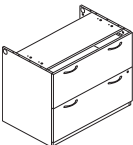
| | DESCRIPTION | MODEL | SHIP WEIGHT | CUBE | L1 LIST | L2 UPCHARGES | |
|--|---|----------------------|-------------|------|---------------|--------------|-------------|
| | | | | | | CHASSIS | FRONTS |
|  | Narrow Box/Box/File Pedestal 9½"W x 29⅞"D x 28½"H | HNL291028PBBF | 64 | 10.6 | \$844 | \$25 | \$10 |
| | 9½"W x 23⅞"D x 28½"H | HNL231028PBBF | 53 | 8.6 | \$756 | \$20 | \$10 |
| NOTES: Efficient, space saving design for smaller footprints. Three locking drawers; two box (supply) drawers, one for files. File drawer has high sides to accept hanging folders; hangrails are included for side-to-side letter or legal filing. Pedestal's top and back are open and require top and back panel components — ordered separately. See chart on page 34 for cord management options. Ships fully assembled. SPECIFYING EXAMPLE: HNL291028PBBF.E.X.H.H | | | | | | | |
|  | Narrow File/File Pedestal 9½"W x 29⅞"D x 28½"H | HNL291028PFF | 69 | 10.6 | \$844 | \$25 | \$10 |
| | 9½"W x 23⅞"D x 28½"H | HNL231028PFF | 54 | 10.6 | \$756 | \$20 | \$10 |
| NOTES: Efficient, space saving design for smaller footprints. Two locking file drawers. Drawers have high sides to accept hanging folders; hangrails are included for side-to-side letter or legal filing. Pedestal's top and back are open and require top and back panel components — ordered separately. See chart on page 34 for cord management options. Ships fully assembled. SPECIFYING EXAMPLE: HNL291028PFF.E.X.H.H | | | | | | | |
|  | Box/Box/File Pedestal 15¾"W x 29⅞"D x 28½"H | HNL291628PBBF | 76 | 10.6 | \$857 | \$25 | \$10 |
| | 18"W x 23⅞"D x 28½"H | HNL231828PBBF | 72 | 9.8 | \$860 | \$20 | \$10 |
| | 15¾"W x 23⅞"D x 28½"H | HNL231628PBBF | 69 | 8.6 | \$782 | \$20 | \$10 |
| NOTES: Three locking drawers; two box (supply) drawers, one for files. File drawer has high sides to accept hanging folders; hangrails are included for side-to-side letter or legal filing; and front-to-back for letter filing. Pedestal's top and back are open and require top and back panel components — ordered separately. See chart on page 34 for cord management options. Ships fully assembled. SPECIFYING EXAMPLE: HNL291628PBBF.E.X.H.H | | | | | | | |
|  | File/File Pedestal 15¾"W x 29⅞"D x 28½"H | HNL291628PFF | 78 | 10.6 | \$857 | \$25 | \$10 |
| | 18"W x 23⅞"D x 28½"H | HNL231828PFF | 72 | 9.8 | \$860 | \$20 | \$10 |
| | 15¾"W x 23⅞"D x 28½"H | HNL231628PFF | 70 | 8.6 | \$782 | \$20 | \$10 |
| NOTES: Two locking file drawers. Drawers have high sides to accept hanging folders; hangrails are included for side-to-side letter or legal filing; and front-to-back for letter filing. Pedestal's top and back are open and require top and back panel components — ordered separately. See chart on page 34 for cord management options. Ships fully assembled. SPECIFYING EXAMPLE: HNL291628PFF.E.X.H.H | | | | | | | |
|  | Lateral File Pedestal 36"W x 23⅞"D x 28½"H | HNL233628PLF | 134 | 18.4 | \$1155 | \$40 | \$20 |
| | 30"W x 23⅞"D x 28½"H | HNL233028PLF | 115 | 15.0 | \$1054 | \$35 | \$20 |
| NOTES: Two locking file drawers; drawers include hangrails to accept folders in letter or legal size. For use under 24"D rectangle worksurface. Widths can also span depth dimension of respective 30" or 36"D rectangle worksurface. Anti-tip design includes mechanical interlock to inhibit the extension of more than one drawer at a time. Pedestal's top and back are open and require top and back panel components — ordered separately. See chart on page 34 for cord management options. Ships fully assembled. SPECIFYING EXAMPLE: HNL233628PLF.E.X.H.H | | | | | | | |

NOTES:

- 29⅞"D pedestals can be used under 30" or 36"D worksurfaces; 23⅞"D pedestals can be used under 24" or 30"D worksurfaces.
- Drawers operate on steel ball-bearing suspensions to ensure smooth, quiet, long-lasting operation; full extension allows easy access to contents.
- Interchangeable core removable locks allow users to access all furniture pieces in an office with a single key for convenience and security. Makes re-keying quick and easy.
- See chart on page 34 for cord management options. If the pedestal grommet option is chosen, two cutouts, one per end/side panel, each with a black plastic cap, are included.

ⓘ Pedestal tops and backs are open and require top and back panel components — ordered separately.

ⓘ 9½"W pedestals are not designed to be used independently in a stand-alone application.

HOW TO SPECIFY

| Select Model Number | Select Handle | Select Grommet | Select Chassis Color | Select Drawer Front Color |
|-----------------------------|--|-------------------------|----------------------|---------------------------|
| A B C D E F | A Cylinder – Satin B Cylinder – Black C Canopy – Satin D Canopy – Black E Loop – Satin F Loop – Black | P Black X No Grommet | See page 29 | See page 29 |
| H N L 2 9 1 0 2 8 P B B F . | E . | X . | H . | H . |

CONCINNITY™ Components — Supports

GSA SIN 33721



Icon Legend on page 19

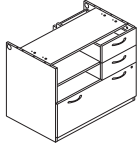

DESCRIPTION

Shelf/Box/Box/Lateral File Pedestal

36"W x 23 1/8"D x 28 1/2"H
30"W x 23 1/8"D x 28 1/2"H

MODEL

HNL233628PSL
HNL233028PSL

SHIP WEIGHT

145
126

CUBE

18.4
15.0

L1 LIST

\$1362
\$1336

L2 UPCHARGES

CHASSIS \$40
FRONTS \$20

NOTES: Versatile unit features an open shelf and three drawers; two for supplies and one for files. For use under 24"D rectangle worksurface. Widths can also span depth dimension of respective 30" or 36"D rectangle worksurface. Box (supply) drawers are located on the right and open shelves on the left. All drawers lock. Pedestal's top and back are open and require top and back panel components — ordered separately. See chart on page 34 for cord management options. Ships fully assembled.

SPECIFYING EXAMPLE: HNL233628PSL.E.X.H.H

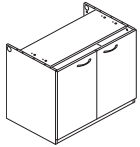

Storage Cabinet Pedestal

36"W x 23 1/8"D x 28 1/2"H
30"W x 23 1/8"D x 28 1/2"H

HNL233628PSC
HNL233028PSC

104
91

18.4
15.0

\$887
\$857

\$40 **\$20**
\$35 **\$20**

NOTES: One adjustable shelf, which adjusts in 2 1/2" increments. For use under 24"D rectangle worksurface. Widths can also span depth dimension of respective 30" or 36"D rectangle worksurface. Doors are non-locking. Pedestal's top and back are open and require top and back panel components — ordered separately. See chart on page 34 for cord management options. Ships fully assembled.

SPECIFYING EXAMPLE: HNL233628PSC.E.X.H.H

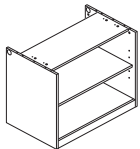

Bookcase Pedestal

36"W x 23 1/8"D x 28 1/2"H
30"W x 23 1/8"D x 28 1/2"H

HNL233628PBK
HNL233028PBK

82
73

18.4
15.0

\$779
\$762

\$40 **N/A**
\$35 **N/A**

NOTES: Two shelves; bottom of unit plus one adjustable shelf, which adjusts in 2 1/2" increments. For use under 24"D rectangle worksurface. Widths can also span depth dimension of respective 30" or 36"D rectangle worksurface. Pedestal's top and back are open and require top and back panel components — ordered separately. See chart on page 34 for cord management options. Ships fully assembled.

SPECIFYING EXAMPLE: HNL233628PBK.X.H

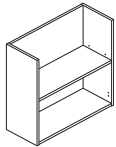

Bookcase End Support

12"W x 36"D x 28 1/2"H
12"W x 30"D x 28 1/2"H
12"W x 24"D x 28 1/2"H

HNL123628BKE
HNL123028BKE
HNL122428BKE

48
48
41

11.0
10.2
7.4

\$587
\$556
\$527

\$25 **N/A**
\$20 **N/A**
\$20 **N/A**

NOTES: Two shelves; bottom of unit plus one adjustable shelf, which adjusts in 1 1/4" increments. Designed to span the depth dimension of 24", 30", or 36"D rectangle worksurface; shelves can be oriented facing outwards, or inwards towards the user's kneespace. Includes fully finished back. Ships with two (2) extra L-brackets for applications requiring attachment of a laminate modesty panel; the panel brackets to the back of the bookcase end support. Modesty panel specified should be 12" less than the worksurface width. Open top; for use under worksurface only — ordered separately. Ships fully assembled.

SPECIFYING EXAMPLE: HNL123628BKE.H

NOTES:

- 23 1/8"D pedestals can be used under 24" or 30"D worksurfaces.
- Drawers operate on steel ball-bearing suspensions to ensure smooth, quiet, long-lasting operation; full extension allows easy access to contents.
- Interchangeable core removable locks allow users to access all furniture pieces in an office with a single key for convenience and security. Makes re-keying quick and easy.
- See chart on page 34 for cord management options. If the pedestal grommet option is chosen, two cutouts, one per end/side panel, each with a black plastic cap, are included.

! Pedestal tops and backs are open and require top and back panel components — ordered separately.

HOW TO SPECIFY

| | | | | |
|--|---|---|--|---|
| <p>Select Model Number</p> <p>H N L 2 3 3 6 2 8 P S L .</p> | <p>Select Handle</p> <p>A Cylinder – Satin B Cylinder – Black C Canopy – Satin D Canopy – Black E Loop – Satin F Loop – Black</p> <p>E .</p> | <p>Select Grommet</p> <p>P Black X No Grommet</p> <p>X .</p> | <p>Select Chassis Color</p> <p>See page 29</p> <p>H .</p> | <p>Select Drawer Front Color</p> <p>See page 29</p> <p>H</p> |
|--|---|---|--|---|



Icon Legend on page 19

CONCINNITY™ Components — Supports

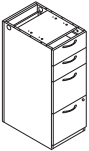
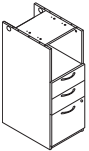
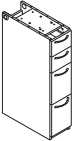
| | DESCRIPTION | MODEL | SHIP WEIGHT | CUBE | L1 LIST | L2 UPCHARGES | |
|---|---|-----------------------|-------------|------|---------------|--------------|-------------|
| | | | | | | CHASSIS | FRONTS |
|  | Box/Box/File/File Pedestal 15¾"W x 29⅞"D x 41"H | HNL291641PBBFF | 114 | 14.7 | \$1753 | \$45 | \$10 |
| | 15¾"W x 23⅞"D x 41"H | HNL231641PBBFF | 102 | 11.9 | \$1645 | \$40 | \$10 |
| <p>NOTES: Four drawers: two box (supply) and two file. File drawer has high sides to accept hanging folders; hangrails are included for side-to-side letter or legal filing; and front-to-back for letter filing. The two box drawers do not lock. Pedestal's top and back are open and require top and back panel components — ordered separately. See chart on page 34 for cord management options. Ships fully assembled. SPECIFYING EXAMPLE: HNL291641PBBFF.E.X.H.H</p> | | | | | | | |
|  | Shelf/Box/Box/File Pedestal 15¾"W x 29⅞"D x 41"H | HNL291641PSBBF | 99 | 14.7 | \$1753 | \$45 | \$10 |
| | 15¾"W x 23⅞"D x 41"H | HNL231641PSBBF | 89 | 11.9 | \$1645 | \$40 | \$10 |
| <p>NOTES: Open shelf over three drawers: two box (supply) and one file. Interior dimensions of the open storage area are: 14⅞"W x 28¼"D x 12¼"H for the 29⅞"D pedestal. 14⅞"W x 22¼"D x 12¼"H for the 23⅞"D pedestal. File drawer has high sides to accept hanging folders; hangrails are included for side-to-side letter or legal filing; and front-to-back for letter filing. All drawers lock. Pedestal's top and back are open and require top and back panel components — ordered separately. See chart on page 34 for cord management options. Ships fully assembled. SPECIFYING EXAMPLE: HNL291641PSBBF.E.X.H.H</p> | | | | | | | |
|  | Narrow Box/Box/File/File Pedestal 9½"W x 29⅞"D x 41"H | HNL291041PBBFF | 88 | 14.7 | \$1543 | \$45 | \$20 |
| | 9½"W x 23⅞"D x 41"H | HNL231041PBBFF | 79 | 11.9 | \$1446 | \$40 | \$20 |
| <p>NOTES: Efficient, space saving design for smaller footprints. Four drawers: two box (supply) and two file. File drawers have high sides to accept hanging folders; hangrails are included for side-to-side letter or legal filing. When used in a double pedestal configuration under a 60" and 48"W worksurface, provides 41" and 29" of kneespace width, respectively. The two box drawers do not lock. Pedestal's top and back are open and require top and back panel components — ordered separately. See chart on page 34 for cord management options. Ships fully assembled. SPECIFYING EXAMPLE: HNL291041PBBFF.E.X.H.H</p> | | | | | | | |

NOTES:

- Pedestals for standing-height workstations.
- 29⅞"D pedestals can be used under 30" or 36"D worksurfaces; 23⅞"D pedestals can be used under 24" or 30"D worksurfaces.
- Drawers operate on steel ball-bearing suspensions to ensure smooth, quiet, long-lasting operation; full extension allows easy access to contents.
- See chart on page 34 for cord management options. If the pedestal grommet option is chosen, two cutouts, one per end/side panel, each with a black plastic cap, are included.
- ! Pedestal tops and backs are open and require top and back panel components — ordered separately.
- ! 9½"W pedestals are not designed to be used independently in a stand-alone application.

HOW TO SPECIFY

| | | | | |
|--------------------------------------|---|---|---|--|
| <p>Select Model Number</p> | <p>Select Handle</p> <p>A Cylinder – Satin B Cylinder – Black C Canopy – Satin D Canopy – Black E Loop – Satin F Loop – Black</p> | <p>Select Grommet</p> <p>P Black X No Grommet</p> | <p>Select Chassis Color</p> <p>See page 29</p> | <p>Select Drawer Front Color</p> <p>See page 29</p> |
| <p>H N L 2 9 1 6 4 1 P B B F F .</p> | <p>E .</p> | <p>X .</p> | <p>H .</p> | <p>H</p> |

CONCINNITY™

Components — Pedestal Tops

GSA SIN 33721



Icon Legend on page 19

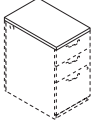

| DESCRIPTION | MODEL | SHIP WEIGHT | CUBE | L1 | L2 |
|----------------------|------------------|-------------|------|--------------|-------------|
| | | | | LIST PRICE | UPCHARGE |
| Pedestal Tops | | | | | |
| 15¾"W x 30"D | HNLPT3016 | 16 | 1.4 | \$254 | \$10 |
| 18"W x 24"D | HNLPT2418 | 15 | 1.3 | \$238 | \$10 |
| 15¾"W x 24"D | HNLPT2416 | 13 | 1.2 | \$238 | \$10 |

NOTES: Component is 1½" thick. Underside of top includes pilot mounting holes for pedestals. Grain direction on 15¾" and 18"W pedestal tops runs horizontal (side-to-side). Component tops for 30" and 36"W pedestals are listed with rectangle worksurface sizes. Grain direction on 30" and 36"W pedestal tops can be specified horizontal (side-to-side) or vertical (front-to-back). For tri-oval and beaded edge options, there is a shaped profile on the user and approach sides, and a flat edge on the ends.

ⓘ For modular pedestals used in freestanding applications; not compatible when pedestal is positioned under a worksurface.

ⓘ 9½"W pedestals are not designed to be used independently in a freestanding application, so 9½"W tops are not available to order.

HOW TO SPECIFY

Select
Model Number

H N L P T 3 0 1 6 .

Select
Edge Profile and Edge Color

See page 29

B H .

Select
Top Color

See page 29

H



CONCINNITY™

Components — Pedestal Back Panels

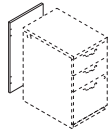
**DESCRIPTION****MODEL****SHIP WEIGHT****CUBE****L1 LIST PRICE****L2 UPCHARGE****Full Back Panels — For 28½”H Pedestals**

18”W x 27⅞”H

HNLBP1828

11

1.5

\$164**\$10**

15¾”W x 27⅞”H

HNLBP1628

10

1.3

\$147**\$10**

9½”W x 27⅞”H

HNLBP1028

6

0.9

\$139**\$10**

NOTES: Encloses the rear of 28½”H modular support pedestals, which come standard with an open, unfinished back. For use when a support storage pedestal is positioned under a 29½”H worksurface and a conventional worksurface width x 27⅞”H modesty/back panel is not specified to cover the back of the pedestal. Examples of when to use a 27⅞” pedestal back include: A worksurface supported by an O-leg on one end and support pedestal on the other, with open wall access; or a worksurface with an O-leg and pedestal support flanking a floating modesty panel. Can be specified in a woodgrain or solid laminate color only. For 30” and 36”W pedestals, use the respective modesty/pedestal back panel size, see page 84.

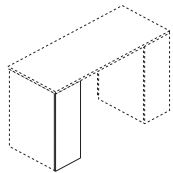
SPECIFYING EXAMPLE (9½”, 15¾”, 18”W): HNLBP1028.H

Back View

Full Back Panels — For 41”H Pedestals

15¾”W x 40⅜”H

HNLBP1641

15

1.8

\$168**\$15**

9½”W x 40⅜”H

HNLBP1041

9

1.2

\$153**\$15**

NOTES: Encloses the rear of 41”H modular support pedestals, which come standard with an open, unfinished back. For use when a support storage pedestal is positioned under a 42”H worksurface and no full-width, 27⅞”H laminate modesty and low, 13”H pedestal back panel are specified. Examples of when to use a 40⅜” pedestal back include: A worksurface supported by an O-leg on one end and support pedestal on the other, with open wall access; or a worksurface with an O-leg and pedestal support flanking a floating modesty panel. Can be specified in a woodgrain or solid laminate color only.

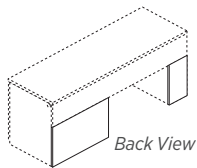
SPECIFYING EXAMPLE: HNLBP1641.H

Back View

Shown with HNLB3018 and HNLB1018

Low Back Panels — For 28½”H Pedestals

36”W x 18”H

HNLB3618

15

1.9

\$164**\$15**

30”W x 18”H

HNLB3018

12

1.6

\$164**\$15**

18”W x 18”H

HNLB1818

7

1.0

\$147**\$15**

15¾”W x 18”H

HNLB1618

6

0.9

\$141**\$10**

9½”W x 18”H

HNLB1018

4

0.6

\$132**\$10**

NOTES: Encloses the rear of 28½”H modular support pedestals when positioned under a 29½”H worksurface with a full-width, 10” laminate modesty panel. The modesty panel extends down from the underside of the worksurface to cover the upper back portion of the pedestal, the lower panel component encloses the remainder of the pedestal back. When used in combination, the 10” modesty and pedestal low back panels fully conceal the rear of the pedestal. The pedestal low back panel is only for use when a modular pedestal is used in conjunction with a worksurface with a 10” laminate modesty panel and the customer wants/needs to fully enclose the back section of the pedestal. Can be specified in a woodgrain or solid laminate color only.

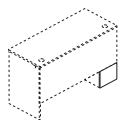

Back View

Low Back Panels — For 41”H Pedestals

15¾”W x 13”H

HNLB1613

4

0.7

\$141**\$10**

9½”W x 13”H

HNLB1013

3

0.5

\$132**\$10**

NOTES: Encloses the rear of 41”H modular support pedestals when positioned under a 42”H worksurface with a full-width, 27⅞” laminate modesty panel. The modesty panel extends down from the underside of the worksurface to cover the upper back portion of the pedestal, the lower panel component encloses the remainder of the pedestal back. When used in combination, the 27⅞” modesty and pedestal low back panels fully conceal the rear of the pedestal. The pedestal low back panel is only for use when a modular pedestal is used in conjunction with a worksurface with a 27⅞” laminate modesty panel and the customer wants/needs to fully enclose the back section of the pedestal. Can be specified in a woodgrain or solid laminate color only.

HOW TO SPECIFY**Select Model Number**

H N L P B 1 8 2 8

Select Laminate Color

See page 29

H

Select Model Number

H N L L B 3 6 1 8

Select Laminate Color

See page 29

H



Refer to page 104 for Center Drawer compatibility information

| DESCRIPTION | MODEL | SHIP WEIGHT | CUBE | L1 LIST PRICE | L2 UPCHARGE |
|---|--------------|-------------|------|---------------|-------------|
| Laminate Center Drawer | | | | | |
| 26" x 15 ³ / ₈ " | H1526 | 12 Ⓞ | 1.2 | \$214 | \$15 |
| 22" x 15 ³ / ₈ " | H1522 | 11 Ⓞ | 1.1 | \$199 | \$15 |
| <ul style="list-style-type: none"> • 12" drawer extension (3/4). • Inside drawer dimension for H1526: 22⁷/₈"W x 15¹/₂"D x 1¹/₂"H. • Inside drawer dimension for H1522: 18⁷/₈"W x 15¹/₂"D x 1¹/₂"H. • Minimum clearance for mounting H1526: 27¹/₄"W x 18¹/₂"D compatible with 72"W x 36"D, 66"W x 30"D, 60"W x 30"D Double Pedestal Desks, 72"W x 24"D, 66"W x 24"D, 60"W x 24"D Credenza w/Kneespace, 48"W x 24"D Return • Minimum clearance for mounting H1522: 22³/₄"W x 18¹/₂"D compatible with 72"W x 36"D, 66"W x 30"D, 60"W x 30"D Double Pedestal Desks, 72"W x 36"D, 66"W x 30"D Single Pedestal Desks, Bullet and P-shaped Peninsulas, 72"W x 24"D, 66"W x 24"D, 60"W x 24"D Credenza w/Kneespace, 72"W x 24"D, 66"W x 24"D Single Pedestal Credenzas, 48"W x 24"D, 42"W x 24"D Returns | | | | | |
| NOTES: Specify laminate for drawer. Model H1522 or H1022 can be used on peninsulas with modesty panel, model HPC180W. Laminate center drawers include pencil tray. For center drawer laminate colors, see page 29. | | | | | |

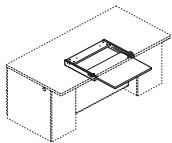

| DESCRIPTION | MODEL | SHIP WEIGHT | CUBE | L1 LIST PRICE | L2 UPCHARGE |
|---|------------------|-------------|------|---------------|-------------|
| Collaborative Desk Shelf | | | | | |
| 25"W x 23"D x 2 ¹ / ₂ "H | HNLCDSELF | 18 | 1.5 | \$370 | \$20 |
| <p>NOTES: Convenient slide-out shelf on approach-side of desk provides workspace for guests. For use with 72"W x 36"D breakfront desk designs — see listings on page 41 — or with 60" or wider worksurface, supported by pedestals, and no modesty panel. Minimum clearance for mounting: 28"W x 19³/₄"D. Fully extended shelf dimensions: 24"W x 19"D. Shelf extends 12³/₈". ³/₄" thick. Not compatible on desks with under-surface center drawer or keyboard platform attached. Can be specified in a woodgrain or solid laminate color only.</p> <p>! Collaborative desk shelf for use with 72"W x 36"D breakfront, floating modesty panel desk designs or with 60" or wider worksurface, supported by pedestals, and no modesty panel.</p> | | | | | |
| SPECIFYING EXAMPLE: HNLCDSELF.H | | | | | |

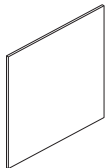

| DESCRIPTION | MODEL | SHIP WEIGHT | CUBE | LIST PRICE |
|---|------------------|-------------|------|--------------|
| Wall Mount Tackboard | | | | |
| 36"W x 35 ¹ / ₄ "H | HNL3636TB | 20 | 2.9 | \$323 |
| 30"W x 35 ¹ / ₄ "H | HNL3630TB | 16 | 2.9 | \$275 |
| 36"W x 48 ⁵ / ₈ "H | HNL4936TB | 27 | 5.5 | \$359 |
| 30"W x 48 ⁵ / ₈ "H | HNL4930TB | 22 | 3.7 | \$312 |
| <p>NOTES: For a list of standard fabrics, see pages 25-26. For a complete list of fabrics, please go to hon.com/fabricsandfinishes. When positioned above 29¹/₂"H floor-standing storage, the sizes align with overhead storage height options. Can be positioned side-by-side with corresponding wall mount markerboard sizes. Easy to install; includes mounting hardware. Attaches to wall with horizontally mounted, interlocking Z-clip brackets. For the space directly below stack-on and wall mount storage cabinets, use the 18"H tackboard models listed on Pricer pages 57 and 63.</p> | | | | |
| SPECIFYING EXAMPLE: HNL3636TB.APN15 | | | | |

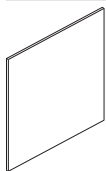

| DESCRIPTION | MODEL | SHIP WEIGHT | CUBE | LIST PRICE |
|--|------------------|-------------|------|--------------|
| Wall Mount Markerboard | | | | |
| 36"W x 35 ¹ / ₄ "H | HNL3636WB | 16 | 2.9 | \$221 |
| 30"W x 35 ¹ / ₄ "H | HNL3630WB | 14 | 2.9 | \$206 |
| 36"W x 48 ⁵ / ₈ "H | HNL4936WB | 22 | 5.5 | \$270 |
| 30"W x 48 ⁵ / ₈ "H | HNL4930WB | 20 | 3.7 | \$249 |
| <p>NOTES: Smooth, white, magnetic surface. Metal material produces clear graphics and cleans easily. Compatible for use with dry- or wet-erase markers. When positioned above 29¹/₂"H floor-standing storage, the sizes align with overhead storage height options. Can be positioned side-by-side with corresponding wall mount tackboard sizes. Easy to install; includes mounting hardware. Attaches to wall with horizontally mounted, interlocking Z-clip brackets.</p> | | | | |
| SPECIFYING EXAMPLE: HNL3636WB | | | | |

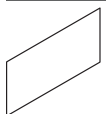

| DESCRIPTION | MODEL | SHIP WEIGHT | CUBE | LIST PRICE |
|---|---------------------|-------------|------|--------------|
| Markerboard | | | | |
| 36"W x 15"D | HLSL1536SOMB | 8 | 1.0 | \$192 |
| 30"W x 15"D | HLSL1530SOMB | 6 | 1.0 | \$143 |
| NOTES: Markerboard laminate material with black edges, no frame. Adheres to laminate doors. Includes double-sided tape. No specification necessary. | | | | |

HOW TO SPECIFY

| | |
|-----------------------|-----------------------|
| Select Model Number | Select Laminate Color |
| H N L C D S H E L F . | H |
| | See page 29 |



Icon Legend on page 19

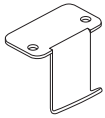

DESCRIPTION

Back Pack Hook (10 per carton)

12"W x 14½"D x 1½"H

NOTES: Assembly: attaches to bottom of desk with (2) screws, included.

⚠ Available in Platinum Metallic finish only, no specification needed.

MODEL

HCLA65

SHIP WEIGHT

10

CUBE

0.1

LIST PRICE

\$101

HOW TO SPECIFY

Select
Model Number

H C L A 6 5



Black only

SIN 33721

DESCRIPTION**MODEL****SHIP WEIGHT****CUBE****LIST PRICE****Field Installable Grommet — For 2½" Diameter Hole****HFLDGRMT**

0.1 Ⓢ

0.01

\$35

- Intended for use in tops and end panels to route/hide cords and in modesty panels to facilitate reaching wall electrical outlets.
- Grommet is field installable.
- Requires a 2½" diameter hole saw and drill for installation (not included).
- Grommet shape is round.
- Includes grommet cap and sleeve.
- Grommet cap measures 3" diameter and includes a ¾" diameter cord access hole.
- Grommet sleeve measures 2½" O.D. x ¾" thick.
- Includes instructions to locate grommet position for desks, credenzas, returns, and bridges.

! Black Finish

SPECIFYING EXAMPLE: HFLDGRMT

SIN 33721

Field Installable Grommet — For 3" Diameter Hole**HFLDGRMT3**

0.1 Ⓢ

0.3

\$35

- Intended for use in tops and end panels to route/hide cords and in modesty panels to facilitate reaching wall electrical outlets.
- Grommet is field installable.
- Requires a 3" diameter hole saw and drill for installation (not included).
- Grommet shape is round.
- Includes grommet cap and sleeve.
- Grommet outside dimensions measures 3½" diameter and includes two cord access holes.
- Grommet sleeve measures 3" O.D. x 1" thick.
- Includes instructions to locate grommet position for desks, credenzas, returns, and bridges.

! Black Finish

SPECIFYING EXAMPLE: HFLDGRMT3

OPEN MARKET

Field Installable Grommet — For 3" Diameter Hole**HFLDGRMT4**

0.1

0.01

\$35

- Intended for use in tops to route/hide cords.
- Requires a 3" diameter hole saw and drill for installation (not included).
- Includes grommet cap, with two access holes, and sleeve components.
- Outside dimension measures 3½" diameter.
- Sleeve hole in worksurface measures 3" O.D. x 1" thick.
- Includes instructions to locate grommet position for desks, credenzas, returns, and bridges.

! Platinum Finish

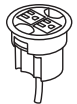
SPECIFYING EXAMPLE: HFLDGRMT4

SIN 33721T

Power Hub, 3" Grommet Mount, 6' Cord**HGRMTAC**

1.3

0.2

\$126

- Fits in 3" round grommet holes on the following product lines: 10500, 10700, Concinnity, Coordinate, and Voi desks; Abound Worksurfaces; Huddle and Motivate tables and SmartLink.
- Two grounded AC power outlets.
- Two cord pass-through holes in cap.
- Includes 6' cord with three-prong plug.
- Field installed; easy plug-and-play.
- UL Listed.

! Available in black only (no color designation so use .X - Specify: HGRMTAC.X).

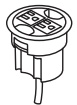

SIN 33721T

3" Round Power Grommet — 2 Outlets, 10' Cord**HGRMTAC2**

1.5

0.2

\$159

- Includes 10' cord with three-prong plug.
- Fits in 3" round grommet holes on the following product lines: Coordinate, Huddle, Motivate, all laminate casegoods series, and Systems Worksurfaces.
- Two grounded AC power outlets.
- Field installed with Plug-and-play ease.

NOTES: Power Modules will also work with standing-height applications for 10500 Series™ and Voi® desks. Optional Memory Control allows preset worksurface heights for consistency. Ships separately. Dynamic load capacity when worksurface is moving is 300 lbs.

! Available in black finish only, no specification needed.



SIN 33721T

Power/USB Hub, 3" Grommet Mount**HGRMTUSB2**

1.3 Ⓢ

0.2

\$250

- One grounded AC power outlet with 2 USB ports.
- Two cord pass-through holes in cap.
- Includes 6' cord with three-prong plug.
- Field installed; easy plug-and-play.
- UL Listed.





! Available in black only (no color designation so use .X - Specify: HGRMTUSB2.X).

HOW TO SPECIFYSelect
Model Number

HGRMTAC

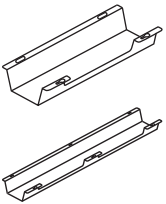

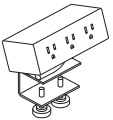
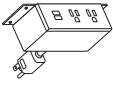
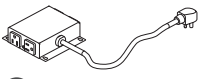
Icon Legend on page 19

| | DESCRIPTION | MODEL | SHIP WEIGHT | CUBE | LIST PRICE |
|---|--|---------------------|---------------|--------------|---------------|
|  | Cable Management Troughs | | | | |
| | 17"W — Single | HCTROUGH17 | 2.7 Ⓔ | 0.5 | \$73 |
| | 17"W — 10-Pack | HCTROUGH1710 | 14.0 Ⓔ | 0.5 | \$665 |
| | 36"W — Single | HCTROUGH36 | 4.9 Ⓔ | 0.9 | \$122 |
| | 36"W — 10-Pack | HCTROUGH3610 | 30.0 Ⓔ | 0.9 | \$1121 |
| | <ul style="list-style-type: none"> • Cable management troughs ship flat packed. • The troughs attach to underneath the worksurface with screws. • The 17"W has one wire access cut out on the user side. The 36" has two wire access cut outs. These cut outs give users access to inside the trough without having to detach it from the worksurface. • Color: Graphite. • Material: Metal. • TAA Compliant. | | | | |
|  OPEN MARKET | O-Leg Cord Clips | | | | |
| | Clips for 28½" Worksurface O-Legs — 8-Pack | HWMCLIPLG | 0.8 Ⓔ | 0.1 | \$110 |
| | Clips for Layering O-Legs — 4-Pack | HWMCLIPSM | 0.5 Ⓔ | 0.1 | \$73 |
| | NOTES: Wire clips work with 7" Low Credenza O-leg and 29"H Support O-leg. ! Available in frosted plastic material only. | | | | |
|  Model HPWRMOD3WC shown | Power Modules | | | | |
| | 3 Receptacles with Worksurface Clamp | HPWRMOD3WC | 2.3 Ⓔ | 0.2 | \$342 |
| | 3 Receptacles with Under-Worksurface Mounting Bracket | HPWRMOD3UWM | 2.3 Ⓔ | 0.2 | \$342 |
| | 2 Receptacles 2 USB with Worksurface Clamp | HPWRMOD2WC | 2.3 Ⓔ | 0.2 | \$546 |
| | 2 Receptacles 2 USB with Under-Worksurface Mounting Bracket | HPWRMOD2UWM | 2.3 Ⓔ | 0.2 | \$546 |
| | <ul style="list-style-type: none"> • 6' power cord with standard three-prong plug. • Under-worksurface mounting bracket models work with any top that has a 5" x 5" square clearance. • Worksurface clamp models work on any top with a 4" overhang. • UL Listed. ! Color finish coordinates with HON's Charcoal or White. Specify <i>STRM</i> for Storm or <i>SNW</i> for Snow when ordering. Example: <i>HPWRMOD3WC.STRM</i> . | | | | |
|  Model HPWRMOD2UWM shown | Power & Data Center | | | | |
| 2 Receptacles 2 Data Accessory | HCOMDOME2 | 2.5 Ⓔ | 0.2 | \$327 | |
| | <ul style="list-style-type: none"> • Standard with two receptacles and openings for two data ports. • 6' power cord with standard three-prong plug. • Fits on any worksurface with a 4" overhang. • UL Listed. ! Color finish coordinates with HON's Loft. Specify <i>LOFT</i> when ordering. Example: <i>HCOMDOME2.LOFT</i> . | | | | |
|  EZ | Under Worksurface Power Module — 4 Outlets, 10' Cord | HPWRMOD2 | 1.5 | 0.2 | \$441 |
| | <ul style="list-style-type: none"> • Includes 10' cord with three-prong plug. • Fits in cable management troughs. • 4 outlets on side create easy access. NOTES: Power Modules will also work with standing-height applications for 10500 Series™ and Voi® desks. ! Available in black finish only, no specification needed. | | | | |
|  | Vertebrae | HMPVWM28 | 3.0 | 0.3 | \$246 |
| | NOTES: 30"H x 3¼"W x 1½"D. Ships unassembled. ! Clear finish. Specify "X" for finish option. SPECIFYING EXAMPLE: HMPVWM28.X | | | | |

HOW TO SPECIFY

Select
Model Number

H P W R M O D 3 W C

CONCINNITY™

Accessories — Paper Organizers

GSA SIN 33721



Icon Legend on page 19

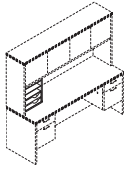

Not available in two-tone laminates

DESCRIPTION**Vertical Paper Manager**14⁷/₈"W x 10⁷/₈"D x 19¹/₈"H**MODEL****HLVPM1****SHIP WEIGHT**

27

CUBE

2.8

L1 LIST PRICE**\$351****L2 UPCHARGE****\$10**

NOTES: Keeps papers, files, and books neatly organized and within easy reach from a seated position. Designed for desk, credenza, and return tops. Fits under stack-on storage models. Two pullout drawers and three fixed shelves. Not available in pattern laminate colors. Ships fully assembled.

ⓘ When used in conjunction with wall mounted storage cabinets, allow 19³/₄" minimum clearance above the worksurface.

SPECIFYING EXAMPLE: HLVPM1.N

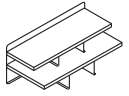

Not available in two-tone laminate

Desktop Storage Terrace26¹/₂"W x 12¹/₂"D x 10¹/₂"H**HLDST1**

24

1.1

\$329**\$10**

NOTES: Keeps work-in-process, priority files, loose pages, and mail neatly organized and in view. Mixed material design comprised of sturdy laminate shelves with metal back and support panels. Not available in two-tone laminate combination or pattern laminate colors. Choose from Platinum Metallic (T1), Black (P), and Charcoal (S) for the metal components. Designed to be used on worksurfaces. Also sized to fit in stack-on and wall mounted storage cabinets, see compatibility chart on page 109.

Specify: Model.Laminate.Paint

SPECIFYING EXAMPLE: HLDST1.N.T1

DESCRIPTION**Stacked Paper Management**32¹/₂"W x 12⁵/₈"D x 4¹/₄"H**MODEL****HLVPM2****SHIP WEIGHT**

22

CUBE

1.25

LIST PRICE**\$175**

NOTES: Segments and organizes stack-on and wall mount storage compartments (see compatibility chart on page 109), as well as bookcase shelves. In some cases, installation may require removing the stack-on or wall mount storage doors.

ⓘ Black only.

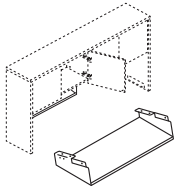
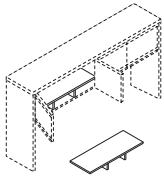
**Hanging Paper Shelf**28¹/₈"W x 11⁷/₈"D x 4⁵/₈"H**HHPS1**

7

2.9

\$214

NOTES: Attaches quickly and easily (screws included). Maximizes worksurface space; de-clutters desktop while placing priority communications and active project folders within easy reach. Angled design allows contents to be distinguished at a glance. Mixed material styling features strong painted metal frame with a frosted shelf.

Attaches quickly and easily to laminate stack-on and wall mount storage models (except the 36"W Voi® overhead hutch with O-legs or panel mount brackets). Not for use with 38000 Series™ and Systems.

Specify: Model.Paint

SPECIFYING EXAMPLE: HHPS1.T1

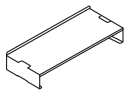
**Desktop Paper Shelf**28¹/₈"W x 11⁵/₈"D x 5"H**HDPS1**

7

2.9

\$214

NOTES: Desktop Paper Shelf and Storage Terrace include protective, non-slip pads on the base. Paper Shelf can stack two-high. Organizer shelf provides a place and space for work-in-process and piling to keep worksurfaces neat and tidy. Convenient, scalable design with interlocking side supports allow two units to be stacked and integrated. Durable painted metal frame with a frosted shelf; mixed material styling matches hanging paper shelf.

Can also be used inside select overhead storage, including the following stack-on with clearance and hinged door models: 10500 and Valido 36", 42", 66", 72", 78"W and 10700 68⁵/₈"W.

Specify: Model.Paint

SPECIFYING EXAMPLE: HDPS1.T1

**Storage Cube**

12"W x 12"D

HLSL1212

1

0.3

\$316

SPECIFYING EXAMPLE: HLSL1212.P8S

**HOW TO SPECIFY**

Select
Model Number

H L V P M 1 .

Select
Laminate Color

See page 29

N

CONCINNITY™ PAPER ORGANIZER COMPATIBILITY

PAPER ORGANIZERS FOR STACK-ON AND WALL MOUNTED STORAGE CABINETS

- Laminate vertical paper manager (HLVPM1) is designed for desk, credenza, and return tops; fits under stack-on and wall mount storage units.
- Laminate desktop storage terrace (HLDST1) for use on worksurfaces, or inside overhead storage compartments >26½"W.
- Metal desktop paper shelf (HDPS1) for use on worksurfaces, can be stacked two high, or inside overhead storage compartments >28¾"W.
- Stacked paper management (HLVPM2) can be positioned inside overhead storage cabinets >32½"W.
- Metal hanging paper shelf (HHPS1) attaches quickly and easily to the underside of stack-on and wall mounted storage models.
- For applications using the organizers inside stack-on and wall mounted storage compartments, the fit compatibility is as follows:

| OUTSIDE WIDTH | INSIDE WIDTH | Stacked Paper Mgt. — 32½"W HLVPM2 | Desktop Paper Shelf — 28¾"W HDPS1 | Desktop Storage Terrace — 26½"W HLDST1 | Hanging Paper Shelf — 28¾"W HHPS1 |
|--|--------------|--------------------------------------|--------------------------------------|---|--------------------------------------|
| | | Yes or No | Yes or No | Yes or No | *Qty — see NOTE |
| STACK-ON STORAGE W/ LAM DOORS, LAM LOCKING DOORS, FROSTED DOORS | | | | | |
| 36"W | 34.34 | Y | Y | Y | 1 |
| 42"W | 40.34 | Y | Y | Y | 1 |
| 48"W (large compartment) | 30.60 | N | Y | Y | 1 |
| 60"W | 28.60 | N | N | Y | 2 |
| 66"W | 31.60 | N | Y | Y | 2 |
| 72"W | 34.60 | Y | Y | Y | 2 |
| 78"W | 37.60 | Y | Y | Y | 2 |
| STACK-ON STORAGE W/ SLIDING DOOR | | | | | |
| 48"W | 22.60 | N | N | N | 1 |
| 60"W | 28.60 | N | N | Y | 2 |
| 66"W | 31.60 | N | Y | Y | 2 |
| 72"W | 34.60 | Y | Y | Y | 2 |
| 78"W | 37.60 | Y | Y | Y | 2 |
| WALL MOUNT STORAGE W/ LAM DOORS, LAM LOCKING DOORS, FROSTED DOORS | | | | | |
| 30"W | 28.35 | N | N | Y | N |
| 36"W | 33.67 | Y | Y | Y | 1 |
| 42"W | 39.67 | Y | Y | Y | 1 |
| 48"W (large compartment) | 30.22 | N | Y | Y | 1 |
| 60"W | 28.22 | N | N | Y | 2 |
| 66"W | 31.22 | N | Y | Y | 2 |
| 72"W | 34.22 | Y | Y | Y | 2 |
| 78"W | 37.22 | Y | Y | Y | 2 |
| WALL MOUNT STORAGE W/ SLIDING DOOR | | | | | |
| 48"W | 22.46 | N | N | N | 1 |
| 60"W | 28.46 | N | N | Y | 2 |
| 66"W | 31.46 | N | Y | Y | 2 |
| 72"W | 34.46 | Y | Y | Y | 2 |
| 78"W | 37.46 | Y | Y | Y | 2 |

*NOTE: For model HHPS1, quantity represents the number that can be mounted side-by-side under the cabinet.





CONCINNITY™

Accessories — Lock Kits

GSA SIN 33721 EXCEPT AS NOTED

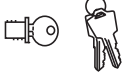

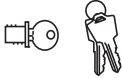
Icon Legend on page 19

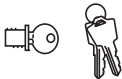
| | DESCRIPTION | MODEL | SHIP WEIGHT | CUBE | LIST PRICE |
|--|--|------------------------------|---|--------------|----------------------------|
|  | Black Removable Lock Core Kit <ul style="list-style-type: none"> Specify quantity of each key number from 101E-225E. Includes: 1-core, 2-keys, 1-core removal tool, and instructions. NOTES: If key number isn't specified, number will be at random. | HF23B | 0.1  | 0.1 | \$35 |
|  | Satin Removable Lock Core Kit <ul style="list-style-type: none"> Specify quantity of each key number from 101E-225E. Includes: 1-core, 2-keys, 1-core removal tool, and instructions. NOTES: If key number isn't specified, number will be at random. | HF23S | 0.1  | 0.1 | \$47 |
|  | Removable Lock Core Kit Black Satin | HF27B HF27S | 0.2 0.2 | 0.02 0.02 | \$35 \$35 |
| OPEN MARKET | <ul style="list-style-type: none"> For stack-on and wall mounted storage laminate models (with locks) in 10500, 10700, Valido, Voi, Concinnity, and 94000 Series. Specify quantity of each key number from 101E to 225E. Includes: 1-core, 2-keys, 1-core removal tool, and instructions. NOTES: If key number isn't specified, number will be at random. | | | | |

NOTES:

- Interchangeable core removable locks are standard on most HON products.
- Removable lock core kits with specific key number must be ordered to facilitate keying alike in the field.
- For keyed alike locks:
 - Order standard product which will be shipped with factory installed locks and random numbered cores.
 - Order the appropriate quantity of like numbered cores required for each workstation or keyed area.
 - Simply replace the factory installed cores with the replacement cores after product has been installed.
- To install new core:
 - Lock must be in the unlocked position.
 - Insert core removal key and pull core straight out.
 - Insert new core with core removable key, hold core into lock and withdraw core removal key.
 - Retain original core for future use.
- For master key, see model HF22 on page 773.
- To provide normal lead times, key numbers cannot be specified on HON products at time of order. This also eliminates need for tagging and tracking each product's lock number during installation.

HOW TO ORDER CORE REMOVABLE LOCK KITS:

Specify: Model Number.X
Key Number

Examples: HF23S.X121E
HF23S.X (Key number not specified)

NOTES: Key orders without numbers specified will be keyed at random.
Numbers 101E-225E are available.

SAMPLE ORDER:

| Quantity | Model | Key Code |
|----------|--------|----------|
| 4 | HF23B. | X121E |

HOW TO SPECIFY

Select
Model Number

H F 2 3 B



CONCINNITY™

Accessories — Task Lights

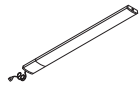

OPEN MARKET

DESCRIPTION**LED Task Lights — For Stack-on and Wall Mounted Storage Cabinets**

17" LED Light with Power Supply (Single)

31" LED Light with Power Supply (Single)

17" LED Light with Power Supply for Daisy-chain (Starter)

31" LED Light with Power Supply for Daisy-chain (Starter)

17" LED Light with 8" Jumper Cord for Daisy-chain (Follower)

31" LED Light with 8" Jumper Cord for Daisy-chain (Follower)

Undercabinet Occupancy Sensor with 1" End to End Connector**MODEL****SHIP WEIGHT****CUBE****LIST PRICE****HLED17AS** ⓘ

1.2

0.05

\$450**HLED31AS** ⓘ

1.5

0.09

\$603**HLED17A**

1.0

0.05

\$493**HLED31A**

1.4

0.09

\$662**HLED17AUO** ⓘ

1.0

0.03

\$404**HLED31AUO** ⓘ

1.0

0.05

\$539**HLEDOSA** ⓘ

0.2

0.01

\$97

NOTES: To use the daisy chain application, must start with model HLED17A or HLED31A. No finish specification required. Attaches magnetically to underside of overhead storage, or attaches with provided screws or double-sided tape. Occupancy sensor attaches to a single or starter LED light and will automatically turn the light off after no motion is detected for 30 minutes. Just like all the LED light models, the occupancy sensor features a soft-touch on/off switch. LED task lights have a lifetime of 50,000 hours and have a dimmer feature that allows the user to adjust the amount of light output.

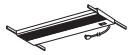

OPEN MARKET

Recessed Task Lights — For Stack-on and Wall Mounted Storage Cabinets

- Color: Black.
- Slim profile design.
- Mount to stack-on storage and wall mounted storage cabinets (see pages 53-57 and 60-63).
- Electronic ballast for increased energy efficiency.
- T5 bulb, included, which contains less mercury.
- 9-foot black cord and switch off right rear corner.

22⁷/₈"W x 3¹/₁₆"D x 1¹/₈"H

Chicago code version (with fused plug)

HH870930

7.0

0.60

\$247**HH870930CH**

7.0

0.60

\$32234⁵/₈"W x 3¹/₁₆"D x 1¹/₈"H

Chicago code version (with fused plug)

HH870942

10.0

0.90

\$267**HH870942CH**

10.0

0.90

\$33946¹/₂"W x 3¹/₁₆"D x 1¹/₈"H

Chicago code version (with fused plug)

HH870960

12.0

1.10

\$290**HH870960CH**

12.0

1.10

\$361

SIN 33721

Articulating Desk Lamp**Articulating Desk Lamp w/ Occupancy Sensor****HLED1**

1.2

6.5

\$430**HLED1OC**

1.2

6.5

\$524

SIN 33721

Task Desk Lamp**HLED2**

0.7

3.0

\$373**HOW TO SPECIFY**Select
Model Number

H H 8 7 0 9 3 0

CONCINNITY™

Accessories

OPEN MARKET EXCEPT AS NOTED



Icon Legend on page 19



Refer to the Workplace Tools section in the 2021 Shared Spaces Pricer for additional product information

SIN 33721



| DESCRIPTION | MODEL | SHIP WEIGHT | CUBE | LIST PRICE BY PAINT GRADE | |
|---|--------------------------|-------------|------|---------------------------|--------------|
| | | | | P1 | P2 |
| Slide-Away Keyboard Platform (Specify: Laminate) | H4022 | 10 | 0.6 | \$228 | |
| Extended Tray Slide-Away Keyboard Platform (Specify: Laminate) | HE4022 | 12 | 0.7 | \$323 | |
| Metal Keyboard and Mouse Tray (Specify paint) | H4028 OPEN MARKET | 11 | 1.5 | \$164 | \$174 |
| Metal Keyboard Tray (Specify paint) | H4029 OPEN MARKET | 11 | 1.5 | \$148 | \$158 |

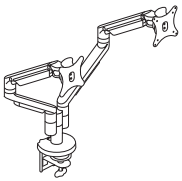

| DESCRIPTION | MODEL | SHIP WEIGHT | CUBE | LIST PRICE |
|--|--------------|-------------|------|--------------|
| Dual Dynamic Monitor Arm <ul style="list-style-type: none"> Arms have 65° rotation at base with optional 130° and 360° rotations. Arms extend 22" and retract up to 3". Monitor mount rotates 180° and tilts +/-30°. Monitor can be rotated from landscape to portrait position. <p>! Arms hold monitors from 6.2-18 lbs. Optional counterweight HPACW available to support monitors as low as 5 lbs. (see the Workplace Tools section in the 2021 Shared Spaces Pricer).</p> | HMASD | 17.0 | 1.1 | \$962 |

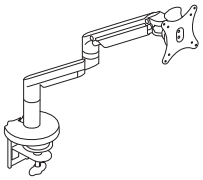

| | | | | |
|--|---------------|------|-----|--------------|
| Single Dynamic Monitor Arm <ul style="list-style-type: none"> 180° of rotation at base with optional 360° rotation. Arms extend 22" and retract up to 3". Monitor mount rotates 180° and tilts +/-30°. Monitor can be rotated from landscape to portrait position. <p>! Arms hold monitors from 6.2-18 lbs. Optional counterweight HPACW available to support monitors as low as 5 lbs. (see the Workplace Tools section in the 2021 Shared Spaces Pricer).</p> | HMASTS | 11.5 | 0.8 | \$501 |
|--|---------------|------|-----|--------------|

NOTES:**Monitor Arms Only**

- Arms fold back to post to allow more desktop room.
- Arms feature double extension, allowing 20"+ of back and forth movement.
- Cable management on both pole and arm assemblies.
- Counterbalance adjustment provides stability for monitors up to 17 lbs per arm.
- Made of high-quality aluminum alloy material.
- See the Workplace Tools section in the 2021 Shared Spaces Pricer for additional monitor arm models.

HOW TO SPECIFY**Select Model Number****Select Finish**

Specify for models HMASD and HMASTS only

SVR Silver
BLK Black

HMASD.

SVR

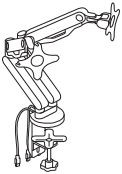

| | DESCRIPTION | MODEL | SHIP WEIGHT | CUBE | LIST PRICE |
|---|--|-----------------|-------------|------|--------------|
|  | <p>Coordinate™ Portable Desktop Riser 31"D x 5"-16½"H x 35"W</p> <p>NOTES: Available in Black (BLK) or White (WHT) finish. Desktop riser dimensions (without keyboard tray): 22"D x 5"-16½"H x 35"W. Keyboard tray dimensions: 9"D x 30"W. Max loading capacity is 33 lbs for the desktop riser surface and 4 lbs for the keyboard tray. Easily transition from seated to standing positions throughout the workday. Sits atop an existing desk to create sit-to-stand functionality by raising the computer. Includes keyboard tray and surface for computer monitors. HON 5-Year Limited Warranty.</p> <p>⚠ Not intended for use on mobile workstations.</p> | HBXRISER | 54.0 | 4.1 | \$657 |
|  | <p>Dual Monitor Arm with 2 USB Ports</p> <p>NOTES: Easy adjustment. Height adjusts to 17" tall. Monitor tilt and swivel capability. Enclosed cable management. Grommet or desktop mounting. Clean appearance. In some applications the Monitor Arms may extend 12 or more inches into the worksurface. For additional information see the Workplace Tools section in the 2021 Shared Spaces Pricer. HON 5-Year Limited Warranty.</p> <p>⚠ No specification needed.</p> | HBDMAUSB | 41.9 | 2.6 | \$410 |

HOW TO SPECIFY

| | |
|--|---|
| <p>Select Model Number</p> <p>H B X R I S E R .</p> | <p>Select Finish</p> <p>BLK Black WHT White</p> <p>B L K</p> |
|--|---|

CONCINNITY™ Accessories

OPEN MARKET



Icon Legend on page 19

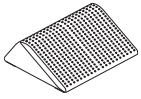

DESCRIPTION

Footrest — Anti-Slip Cover
13¾"D x 5½"H x 16"W

ⓘ Available in Black (T) finish ONLY. Recommended weight capacity not to exceed 250 pounds. **HON 5-Year Limited Warranty.**
SPECIFYING EXAMPLE: HVL991.T

MODEL

SHIP WEIGHT

CUBE

LIST PRICE

HVL991

7 ⓘ

0.9

\$89

HOW TO SPECIFY

Select Model Number

Select Finish

T Black

H V L 9 9 1 .

T

COORDINATE™

Want to see more? Scan here
to check out hon.com.



Coordinate™ Height Adjustable Base shown with Ignition® 2.0 Seating and 10500 Series™ Desking.

COORDINATE™

The power to choose is now at your fingertips — sit tight or stretch out with a Coordinate height adjustable base! It doesn't matter if you're perfecting that project in a private office or collaborating with the crew from your cubicle, Coordinate easily adapts to your body and your day with streamlined style and effortless versatility.



FEATURES

- Make quick and easy adjustments all day long with standard memory preset and hands-free foot pedal, rotor, Wireless, or paddle control options.
- Bases available in 2- or 3-leg rectangle C- and T-shaped foot options to accommodate your layout preferences.
- Newly designed base is lighter scale with a clean aesthetic and easy assembly.
- All bases are compatible with electrical accessories and select worksurfaces.

COORDINATE™ ORDERING INFORMATION

BASE PAINT

| | |
|------------------------|--------------|
| PAINT | CODES |
| ◆ Black | P71 |
| ◆ Charcoal | S |
| ◆ Designer White | PJW |
| ◆ Loft | LOFT |
| ◆ Silver | PR6 |

GROMMET

| | |
|------------------------|--------------|
| GROMMET | CODES |
| ◆ Black | P |
| ◆ Charcoal | S |
| ◆ Designer White | DW |
| ◆ Greige | T5 |
| ◆ Light Gray | Q |
| ◆ Loft | LOFT |
| ◆ Muslin | T3 |
| ◆ Platinum | T1 |
| ◆ Shadow * | SHDW |

LAMINATE

L1 LAMINATES

| | |
|--------------------------|-------------|
| Woodgrain | |
| ◆ Bourbon Cherry | H |
| ◆ Cognac | COGN |
| ◆ Florence Walnut | LFW1 |
| ◆ Harvest | C |
| ◆ Kingswood Walnut | LK11 |
| ◆ Mahogany | N |
| ◆ Mocha | MOCH |
| ◆ Natural Maple | D |
| ◆ Pinnacle | PINC |
| ◆ Shaker Cherry | F |
| ◆ Sterling Ash | LSA1 |

Solid

| | |
|------------------------|-------------|
| ◆ Black | P |
| ◆ Charcoal | S |
| ◆ Designer White | LDW1 |
| ◆ Loft | LOFT |

Patterned

| | |
|---------------------------|-------------|
| ◆ Handspun Chestnut | LAHC |
| ◆ Handspun Dove | LAHD |
| ◆ Handspun Pearl | LAHP |
| ◆ Handspun Slate | LAHS |
| ◆ Sheer Mesh * | A5 |
| ◆ Silver Mesh | B9 |
| ◆ Steel Mesh * | A9 |
| ◆ Canyon Zephyr * | K9 |
| ◆ Desert Zephyr * | K8 |
| ◆ Shadow Zephyr * | K1 |
| ◆ Gray | G2 |
| ◆ Grey Tigris * | L6 |
| ◆ White | G1 |
| ◆ Whitestone * | K4 |

L2 LAMINATES

| | |
|------------------------|-------------|
| Woodgrain | |
| ◆ Lowell Ash | LLA1 |
| ◆ Natural Recon | LNRI |
| ◆ Phantom Ecrú | LPE1 |
| ◆ Portico Teak | LPT1 |
| ◆ Skyline Walnut | LSW1 |

EDGE

EDGE

| | |
|--------------------------|-------------|
| Woodgrain | |
| ◆ Bourbon Cherry | H |
| ◆ Cognac | COGN |
| ◆ Florence Walnut | FW |
| ◆ Harvest | C |
| ◆ Kingswood Walnut | KI |
| ◆ Light Gray | Q |
| ◆ Lowell Ash | DL |
| ◆ Mahogany | N |
| ◆ Mocha | MOCH |
| ◆ Natural Maple | D |
| ◆ Natural Recon | NR |
| ◆ Phantom Ecrú | PE |
| ◆ Pinnacle | PINC |
| ◆ Portico Teak | DP |
| ◆ Shaker Cherry | F |
| ◆ Skyline Walnut | SW |
| ◆ Sterling Ash | SA |

Solid

| | |
|------------------------|-------------|
| ◆ Black | P |
| ◆ Brownstone | EY |
| ◆ Charcoal | S |
| ◆ Designer White | DW |
| ◆ Fossil | EH |
| ◆ Greige | R |
| ◆ Loft | LOFT |
| ◆ Muslin | T |
| ◆ Platinum | K |

SCREEN PAINT

PAINT

| | |
|------------------------|-------------|
| P1 | |
| ◆ Black | P |
| ◆ Brownstone | P7D |
| ◆ Charcoal | S |
| ◆ Designer White | PJW |
| ◆ Fossil | P28 |
| ◆ Greige | T5 |
| ◆ Light Gray | Q |
| ◆ Loft | LOFT |
| ◆ Muslin | T3 |
| ◆ Putty | L |
| ◆ Shadow * | SHDW |
| ◆ Titanium | P8T |

P2

| | |
|----------------------------|------------|
| ◆ Champagne Metallic | T4 |
| ◆ Platinum Metallic | T1 |
| ◆ Silver | PR6 |
| ◆ Solar Black | P8X |

P3

| | |
|---------------------|-------------|
| ◆ Amethyst | P091 |
| ◆ Atom | P8S |
| ◆ Blossom | P8K |
| ◆ Bullseye | PJF |
| ◆ Cabernet * | P7T |
| ◆ Cobalt Mica | P090 |
| ◆ Conifer * | P8H |
| ◆ Ember | P8P |
| ◆ Ion | P8N |
| ◆ Iris | P8J |
| ◆ Krypton | P8F |
| ◆ Ochre | P093 |
| ◆ Regatta | P8M |
| ◆ Sienna | P092 |
| ◆ Succulent | P8A |

LEG OPTIONS



Rectangle Leg, T Foot



Rectangle Leg, C Foot

CONTROL OPTIONS



Basic Up/Down



Memory Control



Paddle



Rotating

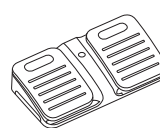

Foot Control



Wireless Dongle*

* Wireless dongle can be used with the AiDesk App.

◆◆◆ For lead time information see page 19.

* De-emphasized

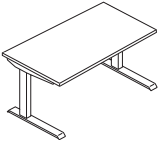

COORDINATE™ Height Adjustable Bases

| | DESCRIPTION | MODEL | SHIP WEIGHT | CUBE | LIST PRICE |
|--|---|-------------------|-------------|------|---------------|
|  | Coordinate™ Height Adjustable Base – 2 Stage | | | | |
| | 2-Leg Rectangle T Foot | HHATB2S2LT | 66 | 2.4 | \$950 |
| | 2-Leg Rectangle C Foot | HHATB2S2LC | 66 | 2.4 | \$950 |
| | NOTES: | | | | |
| | <ul style="list-style-type: none"> • Dual motor two-leg design. Legs raise from 25⁵/₈" to 45¹/₄". • Base accommodates any rectangular worksurface between 23"D x 40"W and 30"D x 72"W. • Weight capacity of 250 lbs. (including the weight of the worksurface) distributed evenly. | | | | |
|  | Coordinate™ Height Adjustable Base – 3 Stage | | | | |
| | 2-Leg Rectangle T Foot | HHATB3S2LT | 66 | 2.4 | \$1047 |
| | 2-Leg Rectangle C Foot | HHATB3S2LC | 66 | 2.4 | \$1047 |
| | NOTES: | | | | |
| | <ul style="list-style-type: none"> • Dual motor two-leg design. Legs raise from 21⁵/₈" to 47³/₄". • Base accommodates any rectangular worksurface between 23"D x 40"W and 30"D x 72"W. • Weight capacity of 250 lbs. (including the weight of the worksurface) distributed evenly. | | | | |
| | Coordinate™ Height Adjustable Base – Max 3 Stage | | | | |
| | 2-Leg Rectangle T Foot | HHATM3S2LT | 66 | 2.4 | \$1173 |
| | NOTES: | | | | |
| | <ul style="list-style-type: none"> • Dual motor two-leg design. Legs raise from 21⁵/₈" to 47³/₄". • Base accommodates any rectangular worksurface between 23"D x 40"W and 30"D x 96"W. • Weight capacity of 350 lbs. (including the weight of the worksurface) distributed evenly. | | | | |
|  | Coordinate™ Height Adjustable Base – 3 Stage | | | | |
| | 3-Leg Rectangle T Foot | HHATB3S3LT | 91 | 3.6 | \$1729 |
| | 3-Leg Rectangle C Foot | HHATB3S3LC | 91 | 3.6 | \$1729 |
| | NOTES: | | | | |
| | <ul style="list-style-type: none"> • Tri-motor three-leg design. Legs raise from 21⁵/₈" to 47³/₄". • Base accommodates worksurfaces between 23"D x 40"W x 40"W and 30"D x 72"W x 72"W. Can be used with 48" 120° worksurface models. • Weight capacity of 375 lbs. (including the weight of the worksurface) distributed evenly. | | | | |
|  | <p>! When using two worksurfaces, a flat bracket is required. Bracket purchased separately — HHN831124, HHN831130 — see page 632.</p> | | | | |

NOTES:

- Control Box: 120V, 4A, 60Hz, 400W.
- 9' grounded power cord.
- 1¹/₂" second travel speed.
- <50 dB noise rating.
- 2-Leg Height Adjustable Bases can accommodate rectangular worksurfaces down to 24"W. 10500 Series™, Concinnity™, and Voi® all have rectangular worksurfaces shorter than 40"W.
- **HON 10-Year Warranty.**

! Requires the use of an external stiffener (purchased separately) for worksurfaces over 58"W or wider when not used with a Coordinate™ worksurface.

HOW TO SPECIFY

| | | | |
|---|---|---|--|
| <p>Select Model Number</p> <p>HHATB3S2LT</p> | <p>Select Paint Color</p> <p>See page 116</p> <p>P71</p> | <p>Select Foot</p> <p>X Standard Foot S Slide Glide</p> <p>X</p> | <p>Select Keypad</p> <p>UD Basic Up/Down MEM Memory Preset PDL Paddle RTG Rotating (+ \$50) FPD Foot Pedal (+ \$175)</p> <p>MEM</p> |
|---|---|---|--|

COORDINATE™ Worksurfaces

OPEN MARKET



Icon Legend on page 19

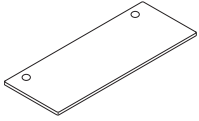

| DESCRIPTION | MODEL | SHIP WEIGHT | CUBE | LIST PRICE BY LAMINATE GRADE | |
|--|-------------|-------------|------|------------------------------|-------|
| | | | | L1 | L2 |
| Rectangle Worksurfaces for Standard C/T Bases, Flat Edge | | | | | |
| 40"W x 22"D | HHATW2240CT | 40 | 2.8 | \$419 | \$434 |
| 46"W x 22"D | HHATW2246CT | 58 | 3.1 | \$446 | \$461 |
| 52"W x 22"D | HHATW2252CT | 64 | 3.9 | \$473 | \$493 |
| 58"W x 22"D | HHATW2258CT | 70 | 3.9 | \$527 | \$547 |
| 64"W x 22"D | HHATW2264CT | 86 | 4.3 | \$566 | \$586 |
| 70"W x 22"D | HHATW2270CT | 89 | 4.6 | \$583 | \$603 |
| 76"W x 22"D | HHATW2276CT | 91 | 5.0 | \$628 | \$653 |
| 82"W x 22"D | HHATW2282CT | 92 | 5.4 | \$702 | \$727 |
| 88"W x 22"D | HHATW2288CT | 94 | 5.7 | \$744 | \$774 |
| 94"W x 22"D | HHATW2294CT | 95 | 6.1 | \$759 | \$789 |
| | | | | | |
| 40"W x 28"D | HHATW2840CT | 55 | 3.4 | \$456 | \$471 |
| 46"W x 28"D | HHATW2846CT | 68 | 3.9 | \$481 | \$496 |
| 52"W x 28"D | HHATW2852CT | 80 | 4.8 | \$517 | \$537 |
| 58"W x 28"D | HHATW2858CT | 101 | 4.8 | \$574 | \$594 |
| 64"W x 28"D | HHATW2864CT | 105 | 5.3 | \$612 | \$632 |
| 70"W x 28"D | HHATW2870CT | 105 | 5.7 | \$653 | \$673 |
| 76"W x 28"D | HHATW2876CT | 107 | 6.1 | \$668 | \$693 |
| 82"W x 28"D | HHATW2882CT | 108 | 6.6 | \$736 | \$761 |
| 88"W x 28"D | HHATW2888CT | 110 | 7.0 | \$781 | \$811 |
| 94"W x 28"D | HHATW2894CT | 111 | 7.5 | \$797 | \$827 |
| <p>! Must be used as worksurfaces on Coordinate™ Height Adjustable Bases within Panel Systems. These are shorter in width and depth on each side to provide clearance between panels and other worksurfaces.</p> | | | | | |
| | | | | | |
| 42"W x 24"D | HHATW2442CT | 52 | 2.8 | \$419 | \$434 |
| 48"W x 24"D | HHATW2448CT | 58 | 3.1 | \$446 | \$461 |
| 54"W x 24"D | HHATW2454CT | 64 | 3.9 | \$473 | \$493 |
| 60"W x 24"D | HHATW2460CT | 70 | 3.9 | \$512 | \$532 |
| 66"W x 24"D | HHATW2466CT | 86 | 4.3 | \$557 | \$577 |
| 72"W x 24"D | HHATW2472CT | 89 | 4.6 | \$571 | \$591 |
| 78"W x 24"D | HHATW2478CT | 96 | 5.0 | \$618 | \$643 |
| 84"W x 24"D | HHATW2484CT | 103 | 5.4 | \$702 | \$727 |
| 90"W x 24"D | HHATW2490CT | 113 | 5.7 | \$744 | \$774 |
| 96"W x 24"D | HHATW2496CT | 121 | 6.1 | \$759 | \$789 |
| | | | | | |
| 42"W x 30"D | HHATW3042CT | 48 | 3.4 | \$456 | \$471 |
| 48"W x 30"D | HHATW3048CT | 68 | 3.9 | \$481 | \$496 |
| 54"W x 30"D | HHATW3054CT | 80 | 4.8 | \$517 | \$537 |
| 60"W x 30"D | HHATW3060CT | 101 | 4.8 | \$559 | \$579 |
| 66"W x 30"D | HHATW3066CT | 105 | 5.3 | \$604 | \$624 |
| 72"W x 30"D | HHATW3072CT | 105 | 5.7 | \$641 | \$661 |
| 78"W x 30"D | HHATW3078CT | 123 | 6.1 | \$659 | \$684 |
| 84"W x 30"D | HHATW3084CT | 127 | 6.6 | \$736 | \$761 |
| 90"W x 30"D | HHATW3090CT | 145 | 7.0 | \$781 | \$811 |
| 96"W x 30"D | HHATW3096CT | 155 | 7.5 | \$797 | \$827 |

! For use with Coordinate™ Height Adjustable Bases only in Freestanding Applications where the tables/desks are not attached or adjacent to another worksurface or systems panel. If used in other than Freestanding Applications, worksurfaces will not provide proper clearance and may cause injury or worksurface damage (not covered by warranty).

HOW TO SPECIFY

Select
Model Number

Select
Laminate

See page 116

Select
Edge Color

See page 116

Select
Grommet and Color

See page 116

X No Grommet
G1 1 Grommet, Centered
G2 2 Grommets, Offset
(not available on C-leg base)

Select
Stiffener Paint

Specify for worksurfaces
58"W or greater

P Black

HHATW2448CT

LSA1

SA

G2P

P



Icon Legend on page 19

| DESCRIPTION | MODEL | SHIP WEIGHT | CUBE | L1 LIST PRICE | L2 LIST PRICE |
|---|---------------|-------------|------|---------------|---------------|
| Corner Cove Worksurfaces, Left Hand | | | | | |
| 58" A x 34" B x 22" C x 22" D | HHATCC583422L | 67 | 6.1 | \$673 | \$698 |
| 58" A x 46" B x 22" C x 22" D | HHATCC584622L | 85 | 7.4 | \$737 | \$767 |
| 58" A x 46" B x 28" C x 28" D | HHATCC584628L | 99 | 7.4 | \$791 | \$821 |
| | | | | | |
| 70" A x 34" B x 22" C x 22" D | HHATCC703422L | 75 | 6.8 | \$736 | \$766 |
| 70" A x 46" B x 22" C x 22" D | HHATCC704622L | 105 | 8.8 | \$918 | \$953 |
| 70" A x 46" B x 28" C x 28" D | HHATCC704628L | 112 | 8.8 | \$974 | \$1009 |
| Corner Cove Worksurfaces, Right Hand | | | | | |
| 58" A x 34" B x 22" C x 22" D | HHATCC583422R | 67 | 6.1 | \$673 | \$698 |
| 58" A x 46" B x 22" C x 22" D | HHATCC584622R | 85 | 7.4 | \$737 | \$767 |
| 58" A x 46" B x 28" C x 28" D | HHATCC584628R | 99 | 7.4 | \$791 | \$821 |
| | | | | | |
| 70" A x 34" B x 22" C x 22" D | HHATCC703422R | 75 | 6.8 | \$736 | \$766 |
| 70" A x 46" B x 22" C x 22" D | HHATCC704622R | 105 | 8.8 | \$918 | \$953 |
| 70" A x 46" B x 28" C x 28" D | HHATCC704628R | 112 | 8.8 | \$974 | \$1009 |

NOTES: Use the 3-Leg Coordinate™ Base when specifying Coordinate™ Corner Cove Worksurfaces.

! Must be used as worksurfaces on Coordinate™ Height Adjustable Bases within Panel Systems. These are shorter in width and depth on each side to provide clearance between panels and other worksurfaces.

| | | | | | |
|---|---------------|-----|-----|-------|--------|
| Corner Cove Worksurfaces, Left Hand | | | | | |
| 60" A x 36" B x 24" C x 24" D | HHATCC603624L | 67 | 6.1 | \$673 | \$698 |
| 60" A x 48" B x 24" C x 24" D | HHATCC604824L | 85 | 7.4 | \$737 | \$767 |
| 60" A x 48" B x 30" C x 30" D | HHATCC604830L | 99 | 7.4 | \$791 | \$821 |
| | | | | | |
| 72" A x 36" B x 24" C x 24" D | HHATCC723624L | 75 | 6.8 | \$736 | \$766 |
| 72" A x 48" B x 24" C x 24" D | HHATCC724824L | 105 | 8.8 | \$918 | \$953 |
| 72" A x 48" B x 30" C x 30" D | HHATCC724830L | 115 | 8.8 | \$974 | \$1009 |
| Corner Cove Worksurfaces, Right Hand | | | | | |
| 60" A x 36" B x 24" C x 24" D | HHATCC603624R | 67 | 6.1 | \$673 | \$698 |
| 60" A x 48" B x 24" C x 24" D | HHATCC604824R | 85 | 7.4 | \$737 | \$767 |
| 60" A x 48" B x 30" C x 30" D | HHATCC604830R | 99 | 7.4 | \$791 | \$821 |
| | | | | | |
| 72" A x 36" B x 24" C x 24" D | HHATCC723624R | 75 | 6.8 | \$736 | \$766 |
| 72" A x 48" B x 24" C x 24" D | HHATCC724824R | 96 | 8.8 | \$918 | \$953 |
| 72" A x 48" B x 30" C x 30" D | HHATCC724830R | 112 | 8.8 | \$974 | \$1009 |

NOTES: Use the 3-leg Coordinate™ Base when specifying Coordinate™ Corner Cove Worksurfaces.

! For use with Coordinate™ Height Adjustable Bases only in Freestanding Applications where the tables/desks are not attached or adjacent to another worksurface or systems panel. If used in other than Freestanding Applications, worksurfaces will not provide proper clearance and may cause injury or worksurface damage (not covered by warranty).

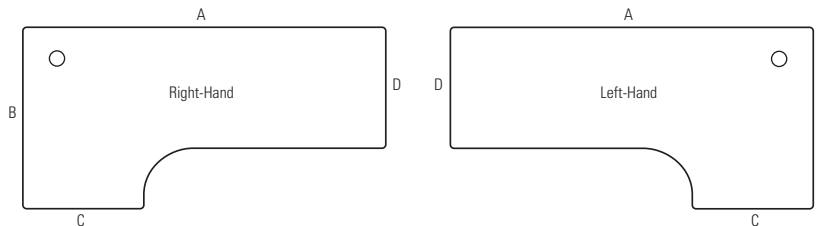

HOW TO SPECIFY

| | | | | |
|---|--|--|---|--|
| Select Model Number HHATCC584622L | Select Laminate See page 116 LSA1 | Select Edge Color See page 116 SA | Select Grommet and Color See page 116 X No Grommet G1 1 Grommet, Corner G2 2 Grommets, Offset (not available on C-leg base) G2P | Select Stiffener Paint P Black |
|---|--|--|---|--|

COORDINATE™ Worksurfaces

OPEN MARKET

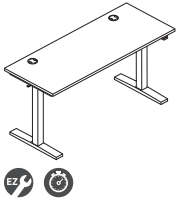

Icon Legend on page 19

**DESCRIPTION****MODEL****SHIP WEIGHT****CUBE****LIST PRICE**

Coordinate™ Easy to Assemble 2-Leg Height Adjustable Base – 2 Stage
24"D Feet

HHABETA2S2L

77

4.0

\$728**NOTES:**

- Legs raise from 26¼" to 43½", excluding worksurface.
- Base telescopes to accommodate rectangular worksurfaces between 24"D x 48"W and 30"D x 60"W.
- Supports weight capacity of 180 lbs.
- Control Box: 100-240V, 3.6A, 50/60Hz, 400W.
- 9' grounded power cord.
- 1½"/second travel speed.
- **HON 5-Year Limited Warranty.**

! Available in SVR Silver finish with Basic Up/Down control only.

SPECIFYING EXAMPLE: HHABETA2S2L.SVR.X.UD

DESCRIPTION**MODEL****SHIP WEIGHT****CUBE****L1
LIST PRICE****L2
LIST PRICE**

Rectangle Worksurfaces for Easy to Assemble Bases, Flat Edge

46"W x 22"D

HHATW2246EA

58

3.1

\$446**\$461**

52"W x 22"D

HHATW2252EA

64

3.9

\$473**\$493**

58"W x 22"D

HHATW2258EA

70

3.9

\$526**\$546**

46"W x 28"D

HHATW2846EA

68

3.9

\$481**\$496**

52"W x 28"D

HHATW2852EA

80

4.8

\$517**\$537**

58"W x 28"D

HHATW2858EA

101

4.8

\$573**\$593**

! Must be used as worksurfaces on Easy to Assemble Coordinate™ Height Adjustable Bases within Panel Systems. These are shorter in width and depth on each side to provide clearance between panels and other worksurfaces.

! For use with Coordinate™ Easy to Assemble Height Adjustable Bases only. Not compatible with standard Coordinate™ 2-leg or 3-leg Height Adjustable Bases.

48"W x 24"D

HHATW2448EA

58

3.1

\$446**\$461**

54"W x 24"D

HHATW2454EA

64

3.9

\$473**\$493**

60"W x 24"D

HHATW2460EA

70

3.9

\$526**\$546**

48"W x 30"D

HHATW3048EA

68

3.9

\$481**\$496**

54"W x 30"D

HHATW3054EA

80

4.8

\$517**\$537**

60"W x 30"D

HHATW3060EA

101

4.8

\$573**\$593**

! For use with Easy to Assemble Coordinate™ Height Adjustable Bases only in Freestanding Applications where the tables/desks are not attached or adjacent to another worksurface or systems panel. If used in other than Freestanding Applications, worksurfaces will not provide proper clearance and may cause injury or worksurface damage (not covered by warranty).

! For use with Coordinate™ Easy to Assemble Height Adjustable Bases only. Not compatible with standard Coordinate™ 2-leg or 3-leg Height Adjustable Bases.

HOW TO SPECIFY

Select
Model Number

HHATW2448EA

Select
Laminate

See page 116

LSA1

Select
Edge Color

See page 116

SA

Select
Grommet and Color

See page 116

- X** No Grommet
- G1** 1 Grommet, Corner
- G2** 2 Grommets, Offset

G2P

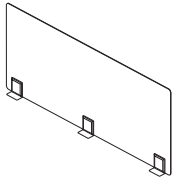

| DESCRIPTION | MODEL | SHIP WEIGHT | CUBE | LIST PRICE BY PAINT GRADE | | |
|---------------------------------|---------------------|-------------|------|---------------------------|--------------|--------------|
| | | | | P1 | P2 | P3 |
| Above Screens | | | | | | |
| 20"H x 45½"W, for 48"W Surfaces | HMTLSCRN2048 | 36.4 | 5.5 | \$684 | \$704 | \$724 |
| 20"H x 51½"W, for 54"W Surfaces | HMTLSCRN2054 | 39.7 | 6.1 | \$718 | \$738 | \$758 |
| 20"H x 57½"W, for 60"W Surfaces | HMTLSCRN2060 | 43.1 | 6.7 | \$755 | \$775 | \$795 |
| 20"H x 63½"W, for 66"W Surfaces | HMTLSCRN2066 | 46.4 | 7.3 | \$792 | \$812 | \$832 |
| 25"H x 45½"W, for 48"W Surfaces | HMTLSCRN2548 | 42.8 | 6.7 | \$752 | \$772 | \$792 |
| 25"H x 51½"W, for 54"W Surfaces | HMTLSCRN2554 | 46.9 | 7.4 | \$790 | \$810 | \$830 |
| 25"H x 57½"W, for 60"W Surfaces | HMTLSCRN2560 | 51.1 | 8.2 | \$829 | \$849 | \$869 |
| 25"H x 63½"W, for 66"W Surfaces | HMTLSCRN2566 | 55.3 | 9.0 | \$871 | \$891 | \$911 |

NOTES:

- Above screens are single-piece steel construction.
- Screens mount by using double stick tape, which provides the ability to mount to any surface.

| DESCRIPTION | MODEL | SHIP WEIGHT | CUBE | LIST PRICE |
|--|---------------|-------------|------|--------------|
| Foot Control Pedal | HFTPDL | 5 | 0.1 | \$188 |
| NOTES: Provides hands-free method for height adjustment. No specification needed. Pedal can be ordered with table or to retrofit on a current table. | | | | |
| Height Adjustable Base Wireless Module | HHABBT | 1 Ⓞ | 0.1 | \$133 |
| NOTES: Allows users to control their base by pairing via the AiDesk App (compatible with both iOS and Android phones). | | | | |

NOTES:

- Provides hands-free method for height adjustment.
- No specification needed.
- Pedal can be ordered with table or to retrofit on a current table.

| DESCRIPTION | MODEL | SHIP WEIGHT | CUBE | LIST PRICE |
|---|-------------------|-------------|------|-------------|
| Caster 4-Pack | HHABCSTRPK | 1 Ⓞ | 0.1 | \$80 |
| ! Field installable. Not available on model HHABETA2S2L. No specification needed. | | | | |
| Slide Glide 4-Pack | HHABGLIDE | 1 Ⓞ | 0.1 | \$64 |
| ! Field installable. When placed under base, allows table to be pushed/pulled to move. No specification needed. | | | | |

HOW TO SPECIFY

| | | |
|--|---|---|
| <p>Select Model Number</p> <p>H M T L S C R N 2 0 5 4 .</p> | <p>Select Frame Paint</p> <p>See page 116</p> <p>P 8 T .</p> | <p>Select Bracket Paint</p> <p>See page 116</p> <p>P 8 T</p> |
|--|---|---|

COORDINATE™ Accessories

GSA SIN AS NOTED

ABI

Icon Legend on page 19

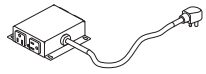

SIN 33721

**DESCRIPTION****Under Worksurface Power Module – 4 Outlets, 10' Cord**

- Includes 10' cord with three-prong plug.
- Fits in cable management troughs. See page 613.
- 4 outlets on side create easy access.

NOTES: Power Modules will also work with standing-height applications for 10500 Series™ and Voi® desks. For additional information see the Workplace Tools section in the 2021 Shared Spaces Pricer.

- ! Available in black finish only, no specification needed.

MODEL**HPWRMOD2****SHIP WEIGHT**

1.5

CUBE

0.2

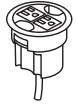
LIST PRICE**\$441**

SIN 33721T

**3" Round Power Grommet – 2 Outlets, 10' Cord**

- Includes 10' cord with three-prong plug.
- Fits in 3" round grommet holes.
- Two grounded AC power outlets.
- Field installed with Plug-and-play ease.

- ! Available in black finish only, no specification needed.

HGRMTAC2

1.5

0.2

\$159

SIN 33721T

**Power/USB Hub, 3" Grommet Mount**

- One grounded AC power outlet with 2 USB ports.
- UL Listed.

NOTES: For additional information see the Workplace Tools section in the 2021 Shared Spaces Pricer.

- ! Available in black only (no color designation so use .X – Specify: HGRMTUSB2.X).

HGRMTUSB2

1.3 Ⓢ

0.2

\$250**Wire Managers for Height Adjustable
Trough to Floor****HMPHATFWML**

2.0

0.3

\$269**OPEN MARKET**

Model HPWRMOD3WC shown

SIN 33721

Dean Power Modules with Worksurface Clamp

- 3 Receptacles
- 2 Receptacles, 2 USB
- 2 Receptacles, 2 USB with Qi Wireless Charging Top
- 6' power cord with standard three-prong plug.
- Worksurface clamp models work on any top with a 4" overhang.
- UL Listed.

HPWRMOD3WC Ⓢ

2.3 Ⓢ

0.2

\$342**HPWRMOD2WC** Ⓢ

2.3 Ⓢ

0.2

\$546**HPWRMOD4WC**

2.3 Ⓢ

0.2

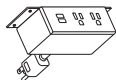
\$738

Model HPWRMOD2UWM shown

SIN 33721

Dean Power Modules with Under-Worksurface Mounting Bracket

- 3 Receptacles
- 2 Receptacles, 2 USB
- 6' power cord with standard three-prong plug.
- Under-worksurface mounting bracket models work with any top that has a 5" x 5" square clearance.
- UL Listed.

HPWRMOD3UWM

2.3 Ⓢ

0.2

\$342**HPWRMOD2UWM**

2.3 Ⓢ

0.2

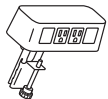
\$546

SIN 33721

**Power & Data Center**

- 2 Receptacles 2 Data Accessory
- Standard with two receptacles and openings for two data ports.
- 6' power cord with standard three-prong plug.
- Fits on any worksurface with a 4" overhang.
- UL Listed.

NOTES: For additional information see the Workplace Tools section in the 2021 Shared Spaces Pricer.

- ! Color finish coordinates with HON's Loft. Specify LOFT when ordering. Example: HCOMDOME2.LOFT.

HCOMDOME2

2.5 Ⓢ

0.2

\$327**HOW TO SPECIFY**

Select
Model Number

H P W R M O D 2



| | DESCRIPTION | MODEL | SHIP WEIGHT | CUBE | L1 LIST PRICE | L2 LIST PRICE |
|-------------|---|---|-------------|------|---------------|---------------|
| | Concinnity™ Rectangle Worksurfaces | | | | | |
| | 48"W x 24"D | HNLRC2448 | 40 | 3.1 | \$302 | \$317 |
| | 60"W x 24"D | HNLRC2460 | 50 | 3.9 | \$358 | \$378 |
| | 66"W x 24"D | HNLRC2466 | 55 | 4.2 | \$387 | \$407 |
| | 72"W x 24"D | HNLRC2472 | 60 | 4.6 | \$402 | \$422 |
| | 48"W x 30"D | HNLRC3048 | 50 | 3.9 | \$330 | \$345 |
| | 60"W x 30"D | HNLRC3060 | 62 | 4.7 | \$404 | \$424 |
| | 66"W x 30"D | HNLRC3066 | 69 | 5.2 | \$433 | \$453 |
| | 72"W x 30"D | HNLRC3072 | 75 | 5.6 | \$470 | \$490 |
| | | 10500 Series™ Rectangle Worksurfaces | | | | |
| 48"W x 24"D | | H105R2448 | 44 | 3.4 | \$280 | \$295 |
| 60"W x 24"D | | H105R2460 | 55 | 4.2 | \$330 | \$350 |
| 66"W x 24"D | | H105R2466 | 61 | 4.9 | \$351 | \$371 |
| 72"W x 24"D | | H105R2472 | 66 | 4.9 | \$363 | \$383 |
| 48"W x 30"D | | H105R3048 | 55 | 4.1 | \$304 | \$319 |
| 60"W x 30"D | | H105R3060 | 69 | 5.2 | \$370 | \$390 |
| 66"W x 30"D | | H105R3066 | 76 | 6.1 | \$397 | \$417 |
| 72"W x 30"D | | H105R3072 | 83 | 6.1 | \$427 | \$447 |

NOTES:

- ❗ For use with Coordinate™ Height Adjustable Bases only in freestanding applications, which are applications where the tables/desks are not attached or adjacent to another unit, table/desk, or systems panel. The widths are true to stated dimensions. If used with Panel Systems or other than in freestanding applications, worksurfaces will not provide proper clearance between panels or other worksurfaces, and may cause injury or worksurface damage (not covered by warranty).
- ❗ Coordinate™ Height Adjustable Bases are not compatible with 36"D rectangular worksurfaces.
- ❗ Coordinate™ Height Adjustable Bases requires the use of an external stiffener (purchased separately) for worksurfaces over 58"W or wider when not used with a Coordinate™ worksurface.

HOW TO SPECIFY

| | | | |
|---|--|--|--|
| <p>Select Model Number</p> | <p>Select Worksurface Laminate and Edge Color</p> <p><i>For Concinnity™ Worksurfaces, see page 29</i> <i>For 10500 Series™ Worksurfaces, see page 266</i></p> | <p>Select Worksurface Grommet Finish</p> <p><i>Specify for Concinnity™ Worksurfaces only</i></p> <p>P Black TI Platinum X No Grommet</p> | <p>Select Worksurface Color</p> <p><i>For Concinnity™ Worksurfaces, see page 29</i></p> |
| <p>H N L R C 2 4 4 8</p> <p>H 1 0 5 R 2 4 4 8</p> | <p>B H</p> <p>N N</p> | <p>P</p> | <p>H</p> |

SYSTEMS WORKSURFACES

120 Degree Corner

GSA SIN 33721



Icon Legend on page 19

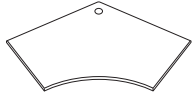

W=panel width
D=worksurface depth

| DESCRIPTION | MODEL | SHIP WEIGHT | CUBE | L1 LIST PRICE | L2 LIST PRICE |
|---|-------------------|-------------|------|---------------|---------------|
| Around® and Accelerate® 120 Degree Corner Worksurfaces with Curved User Edge | | | | | |
| 42"W x 24"D | HBWCT4224P | 96 | 9.2 | \$917 | \$932 |
| 48"W x 24"D | HBWCT4824P | 107 | 9.2 | \$1063 | \$1078 |
| 42"W x 30"D | HBWCT4230P | 102 | 11.4 | \$1205 | \$1220 |
| 48"W x 30"D | HBWCT4830P | 112 | 11.4 | \$1282 | \$1297 |

• One small work surface bracket standard with each work surface.

❗ Corner work surfaces must match exactly the panel behind them, i.e.: a 42" panel must be used on the back two sides of model HBWCT4224P.

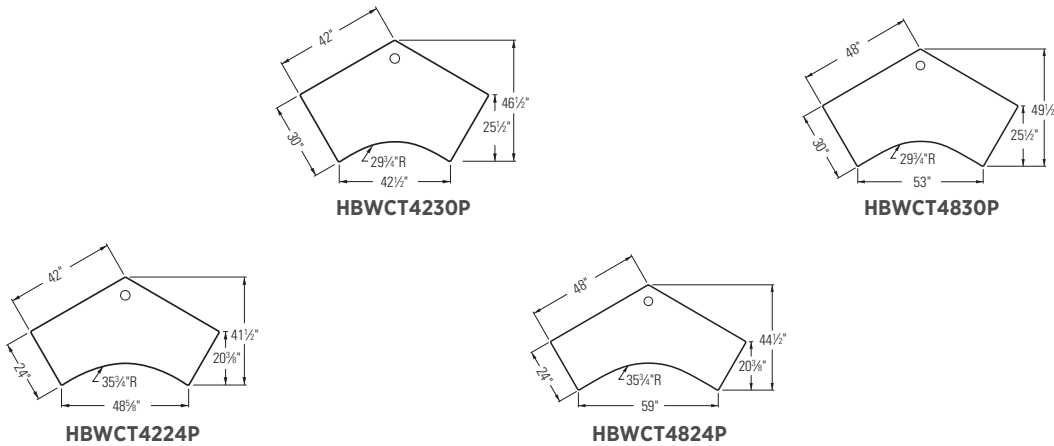

NOTES:

- Worksurfaces are constructed of laminate on 1/8" solid core high-performance particleboard.
- Add suffix **"N"** to Model Number for worksurfaces with no grommets. No upcharge.
- Cannot use keyboard tray or pedestal under 120 degree corner work surface.
- Refer to Worksurface Supports, pages 630-634.
- If used at an end of run, full end panel needs to be ordered — see page 630.

❗ Coordinate™ Height Adjustable Bases requires the use of an external stiffener (purchased separately) for worksurfaces over 58"W or wider when not used with a Coordinate™ work surface.

HOW TO SPECIFY

| | | | |
|--|---|---|--|
| <p>Select Model Number</p> <p>No Grommet option: Add "N" suffix (no upcharge)</p> <p>HBWCT4224P .</p> <p>HBWCT4224PN .</p> | <p>Select Laminate</p> <p>See page 481</p> <p>AS .</p> <p>AS .</p> | <p>Select Edge Color</p> <p>See page 481</p> <p>K .</p> <p>K .</p> | <p>Select Grommet Color</p> <p>See page 481</p> <p>T1</p> |
|--|---|---|--|



COORDINATE™ Shared Components

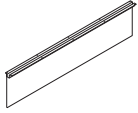

| DESCRIPTION | MODEL | SHIP WEIGHT | CUBE | L1 | L2 |
|--|------------------|-------------|------|--------------|-------------|
| | | | | LIST PRICE | UPCHARGE |
| Laminate Floating Modesty Panel | | | | | |
| 30"W x 14"H | HLSL3014L | 10 | 0.8 | \$191 | \$10 |
| 36"W x 14"H | HLSL3614L | 12 | 0.8 | \$202 | \$10 |
| 42"W x 14"H | HLSL4214L | 14 | 0.8 | \$214 | \$10 |
| 48"W x 14"H | HLSL4814L | 16 | 1.1 | \$236 | \$12 |
| 54"W x 14"H | HLSL5414L | 18 | 1.1 | \$258 | \$12 |
| 60"W x 14"H | HLSL6014L | 20 | 1.1 | \$277 | \$12 |

NOTES: The attachment bracket and modesty panel are packaged separately.
Specify: Model.Laminate.Paint

SPECIFYING EXAMPLE: HLSL3014L.N.P (Black is the only paint option for this model)

- ! When specifying the 54"W or 60"W Laminate Floating Modesty Panel, it is not necessary to specify an external channel.
- ! 30"W and 36"W screens attach with L-brackets, not the external channel.

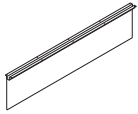

| DESCRIPTION | MODEL | SHIP WEIGHT | CUBE | LIST PRICE |
|--|-------------------|-------------|------|---------------|
| Mixed Material Floating Modesty Panel | | | | |
| 30"W x 14"H | HLSL3014MM | 8 | 2.0 | \$755 |
| 36"W x 14"H | HLSL3614MM | 8 | 2.0 | \$810 |
| 42"W x 14"H | HLSL4214MM | 9 | 2.3 | \$906 |
| 48"W x 14"H | HLSL4814MM | 11 | 2.6 | \$1002 |
| 54"W x 14"H | HLSL5414MM | 13 | 3.3 | \$1089 |
| 60"W x 14"H | HLSL6014MM | 13 | 3.3 | \$1243 |

NOTES: The attachment bracket and modesty panel are packaged separately.
Specify: Model.Mixed Material.Paint

SPECIFYING EXAMPLE: HLSL3014MM.FT01.P (Frosted Translucent mixed material and Black paint are the only options for this model)

- ! When specifying the 54"W or 60"W Mixed Material Floating Modesty Panel, it is not necessary to specify an external channel.

| FLOATING MODESTY PANELS – MODEL SELECTION GUIDE | | | | |
|---|----------|----------|----------|----------|
| Rectangle Worksurface Width | | | | |
| 72 in | 66 in | 60 in | 48 in | 42 in |
| HLSL6014 | HLSL5414 | HLSL4814 | HLSL3614 | HLSL3014 |

NOTES:

- When using a floating modesty panel under the worksurface, the depth clearance for center drawers and keyboard platforms decreases by 8".

HOW TO SPECIFY

| | |
|---|--|
| <p>Select Model Number</p> <p>HLSL3014MM</p> | <p>Select Mixed Material</p> <p>FT01 Frosted Translucent</p> <p>FT01</p> |
|---|--|

COORDINATE™

Accessories

OPEN MARKET



Icon Legend on page 19

**DESCRIPTION****Portable Desktop Riser**

31"D x 5"-16½"H x 35"W

NOTES: Available in Black (BLK) or White (WHT) finish. Desktop riser dimensions (without keyboard tray): 22"D x 5"-16½"H x 35"W. Keyboard tray dimensions: 9"D x 30"W. Max loading capacity is 33 lbs for the desktop riser surface and 4 lbs for the keyboard tray. Easily transition from seated to standing positions throughout the workday. Sits atop an existing desk to create sit-to-stand functionality by raising the computer. Includes keyboard tray and surface for computer monitors. **HON 5-Year Limited Warranty.**

⚠ Not intended for use on mobile workstations.

MODEL**HBXRISER****SHIP WEIGHT**

54.0

CUBE

4.1

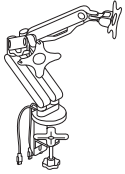
LIST PRICE**\$657****Dual Monitor Arm with 2 USB Ports**

NOTES: Easy adjustment. Height adjusts to 17" tall. Monitor tilt and swivel capability. Enclosed cable management. Grommet or desktop mounting. Clean appearance. In some applications the Monitor Arms may extend 12 or more inches into the worksurface. For additional information see the Workplace Tools section in the 2021 Shared Spaces Pricer. **HON 5-Year Limited Warranty.**

⚠ No specification needed.

HBDMAUSB

41.9

2.6

\$410**HOW TO SPECIFY**
**Select
Model Number**
**Select
Finish**
BLK Black
WHT White

HBXRISER.
BLK

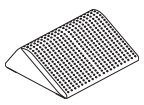

Icon Legend on page 19

| | DESCRIPTION | MODEL | SHIP WEIGHT | CUBE | LIST PRICE |
|---|---|----------------------|-------------|------------|--------------------|
|  | <p>Footrest — Anti-Slip Cover 13¾"D x 5½"H x 16"W</p> <p>ⓘ Available in Black (T) finish ONLY. Recommended weight capacity not to exceed 250 pounds. HON 5-Year Limited Warranty. SPECIFYING EXAMPLE: HVL991.T</p> | <p>HVL991</p> | <p>7 ⓘ</p> | <p>0.9</p> | <p>\$89</p> |

HOW TO SPECIFY

| | |
|---|--|
| <p>Select Model Number</p> <p>H V L 9 9 1 .</p> | <p>Select Finish</p> <p>T Black</p> <p>T</p> |
|---|--|

COZE™

Want to see more? Scan here
to check out hon.com.



Coze™ Table Desk shown with
Cliq™ Seating and Fuse™ Storage.

COZE™



There's no place like home, especially when you're working. Stay as productive in your own digs as you are in the office with Coze table desks. Designed to keep things nice and easy, Coze features simple and quick assembly and optional fast shipping so you can get down to business in no time. Not too big and not too small, Coze comes in three sizes, so it's just right for whatever space you're working in. With optional built-in storage to help you stay organized and a clean, light-scale look in a variety of laminate and finish colors, Coze feels right at home no matter your personal style.



FEATURES

- Enjoy a higher quality desk at a lower price.
- Simple one-tool installation with video takes only minutes.
- Light scale design and small footprint fit any room in the house.
- Optional integrated storage lets you decide how to best stay organized.
- Available in a variety of laminate and paint colors so you can get exactly what you need in the look you want.
- Leveling glides adjust for uneven floors.
- Durable laminate surfaces resist scratches, spills, and stains.

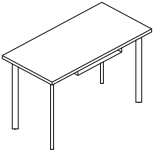

| | DESCRIPTION | MODEL | SHIP WEIGHT | CUBE | LIST PRICE |
|---|--|-------------------------|-------------|------|--------------|
|  | Table Desk with Post Legs | | | | |
| | 54"W x 24"D | HLCRPL5424WFH | 71 | 5.7 | \$570 |
| | 48"W x 24"D | HLCRPL4824WFH | 66 | 5.4 | \$543 |
| | 42"W x 24"D | HLCRPL4224WFH | 61 | 5.2 | \$516 |
| | 54"W x 30"D | HLCRPL5430WFH | 81 | 6.3 | \$650 |
| | 48"W x 30"D | HLCRPL4830WFH | 76 | 5.9 | \$628 |
| | NOTES: Product ships with desk top and 4 legs in 2 cartons. | | | | |
|  | Table Desk with Post Legs and U-Storage | | | | |
| | 54"W x 24"D | HLCRPL5424WFH-US | 78 | 5.7 | \$630 |
| | 48"W x 24"D | HLCRPL4824WFH-US | 73 | 5.4 | \$603 |
| | 42"W x 24"D | HLCRPL4224WFH-US | 68 | 5.2 | \$576 |
| | 54"W x 30"D | HLCRPL5430WFH-US | 88 | 6.3 | \$710 |
| | 48"W x 30"D | HLCRPL4830WFH-US | 83 | 5.9 | \$688 |
| | NOTES: Product ships with desk top, 4 legs, and U-storage in 2 cartons. | | | | |
|  | Table Desk with Post Legs and Pencil Storage | | | | |
| | 54"W x 24"D | HLCRPL5424WFH-PS | 77 | 5.7 | \$630 |
| | 48"W x 24"D | HLCRPL4824WFH-PS | 72 | 5.4 | \$603 |
| | 42"W x 24"D | HLCRPL4224WFH-PS | 67 | 5.2 | \$576 |
| | 54"W x 30"D | HLCRPL5430WFH-PS | 87 | 6.3 | \$710 |
| | 48"W x 30"D | HLCRPL4830WFH-PS | 82 | 5.9 | \$688 |
| | NOTES: Product ships with desk top, 4 legs, and pencil storage in 2 cartons. | | | | |

NOTES:

- **HON 5-Year Limited Warranty.**

HOW TO SPECIFY

| | | |
|--|---|--|
| <p>Select Model Number</p> | <p>Select Laminate and Edge</p> <p>PP Black LDW1DW Designer White LFW1FW Florence Walnut LNR1NR Natural Recon</p> | <p>Select Paint Color</p> <p>P71 Black PJW Designer White PR6 Silver</p> |
| <p>H L C R P L 4 8 2 4 W F H - U S .</p> | <p>L F W 1 F W .</p> | <p>P R 6</p> |

COZE™ Table Desks

OPEN MARKET



Icon Legend on page 19

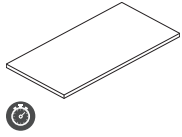

DESCRIPTION

Coze™ Rectangle Worksurface

42"W x 24"D
48"W x 24"D
54"W x 24"D

48"W x 30"D
54"W x 30"D

NOTES: Compatible with Coordinate™ Height Adjustable Base model HHABETA2S2L. Base telescopes to accommodate worksurfaces between 24"D x 48"W and 30"D x 60"W. Worksurfaces include pre-drilled pilot holes. Worksurfaces come with threaded inserts for ease of installation with Post Legs models HLCPL29WFH, HLCPL29WFH-US, and HLCPL29WFH-PS.

MODEL

SHIP WEIGHT

CUBE

LIST PRICE

| | | | |
|--------------------|----|-----|--------------|
| HLCR2442WFH | 35 | 2.1 | \$269 |
| HLCR2448WFH | 40 | 2.4 | \$296 |
| HLCR2454WFH | 45 | 2.7 | \$323 |
| HLCR3048WFH | 50 | 2.9 | \$381 |
| HLCR3054WFH | 55 | 3.3 | \$403 |

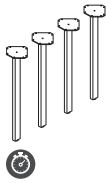

Post Legs, Pack of 4

HLCPL29WFH

26

3.0

\$247

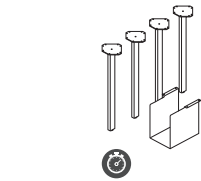

Post Legs, Pack of 4 with U-Storage

NOTES: Metal storage ships same color as legs.

HLCPL29WFH-US

33

3.0

\$307

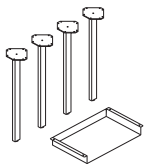

Post Legs, Pack of 4 with Pencil Storage

NOTES: Metal storage ships same color as legs.

HLCPL29WFH-PS

32

3.0

\$307

ⓘ Hardware included is specific to the attachment of the following models: HLCR2442WFH, HLCR2448WFH, HLCR2454WFH.

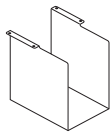

U-Storage

HLCWFH-US

9

1.2

\$151

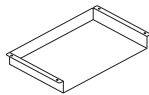

Pencil Storage

HLCWFH-PS

8

1.2

\$151

ⓘ Hardware included is specific to the attachment of the following models: HLCR2442WFH, HLCR2448WFH, HLCR2454WFH.

NOTES:

- HON 5-Year Limited Warranty.

HOW TO SPECIFY

Select Model Number

H L C R 2 4 4 8 W F H .

Select Laminate and Edge

- PP** Black
- LDW1DW** Designer White
- LFW1FW** Florence Walnut
- LNR1NR** Natural Recon

L F W 1 F W

Select Model Number

H L C P L 2 9 W F H - P S .

Select Paint Color

- P71** Black
- PJW** Designer White
- PR6** Silver

P R 6

MOD

Want to see more? Scan here
to check out hon.com.



Mod Desks shown with Coordinate™ Height Adjustable Tables and Solve® Seating.

MOD

There is always beauty in simplicity, but with the Mod desk collection you'll also find variety and value. The contemporary design feels perfectly at home in either a private office or an open floor plan, giving it the versatility that allows you to unify your space. Choose from a selection of finishes that express your modern sense of style, or dress it up with a classic look. Whether setting up a single desk, shared workstations, or full private office suite with storage, this collection is totally adaptable. Totally productive. Totally Mod.



FEATURES

- The Mod collection allows you to create a premium workspace at an affordable price.
- Straightforward styling blends with any office design with the option for metal A- and U-legs.
- Available in 6 laminate finishes.
- Storage options that let you create spaces that work the way you do.
- All components feature a scratch- and stain-resistant laminate for unbeatable beauty and durability.

MOD ORDERING INFORMATION

LAMINATES

L1 LAMINATES CODES

Woodgrain

- ◆ Java Oak LJA1
- ◆ Russet Cherry LRC1
- ◆ Sepia Walnut LSE1
- ◆ Slate Teak LSL1
- ◆ Traditional Mahogany LTM1

Solid

- ◆ Simply White* LPW1

METAL A-LEGS, U-LEGS, AND SUPPORT LEGS

PAINTS CODES

- ◆ Black BLKP
- ◆ Silver SLVR

FABRIC CUSHIONS & TACKBOARDS

FABRIC CODES

- ◆ Cool Neutral CN02
- ◆ Warm Neutral WM01

* The solid laminate finish Simply White (LPW1) is available on limited base models; reference the "How to Specify" for model by model clarification.

◆◆◆ For lead time information see page 19.

MOD LAMINATE GRAIN DIRECTION

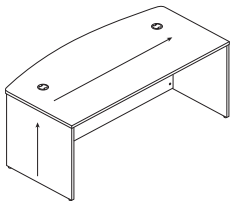

Bow Top Desk Shell

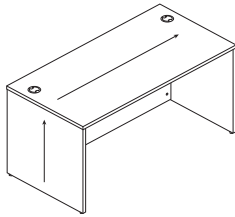

Rectangle Desk Shell

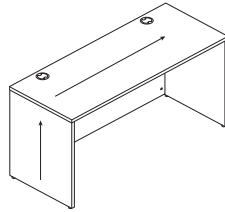

Rectangle Credenza Shell

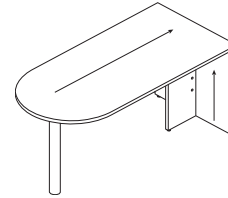

Peninsula

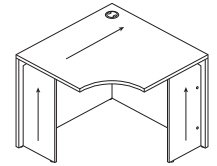

Corner Shell

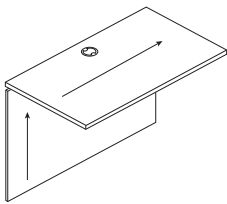

Bridge

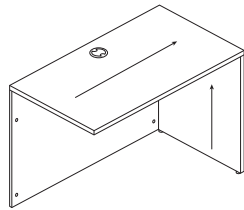

Return

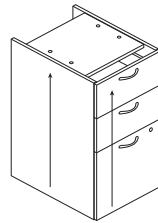

Pedestals

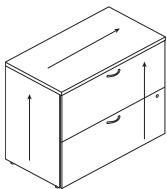
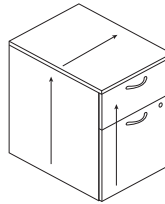

Laterals

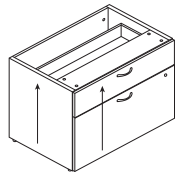

Low Credenzas

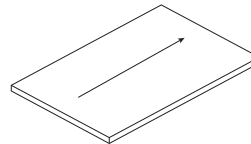
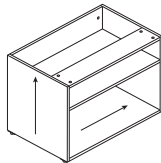

Low Credenza Top



Wardrobe

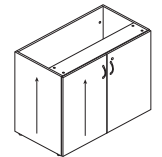

Storage Cabinet

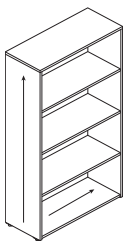

Bookcase

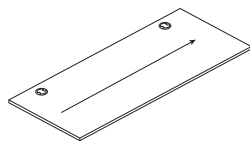

Rectangle Worksurface

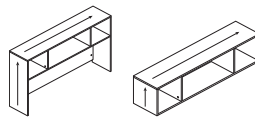

Overhead Hutch, Storage, and Laminate Doors

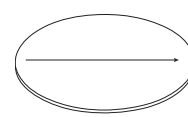

Conference Table Tops and Bases

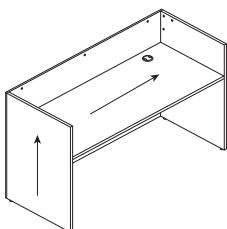
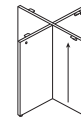

Reception Desk and Transaction Top

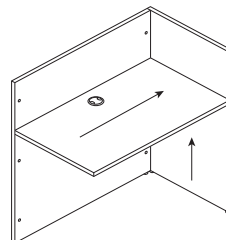
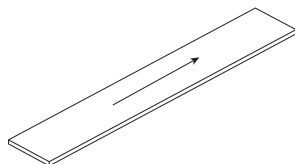

Reception Return Shell

MOD Typicals

Components used are listed on pages 140-148. Order components individually. Other configurations are possible, including various sizes of some components.

| QTY | DESCRIPTION | MODEL | LIST PRICE | PRICE EXTENSION |
|---------------|---|------------|------------|-----------------|
| 1 | Desk Shell 66"W x 30"D | HLPLDS6630 | \$300 | \$300 |
| 1 | Credenza Shell 66"W x 24"D | HLPLCS6624 | \$279 | \$279 |
| 1 | Bridge 42"W x 24"D | HLPLB4224 | \$171 | \$171 |
| 1 | Pedestal - B/B/F 15"W x 20"D x 28"H | HLPLPSBBF | \$334 | \$334 |
| 1 | Pedestal - F/F 15"W x 20"D x 28"H | HLPLPSFF | \$334 | \$334 |
| 1 | Hutch without Doors 66"W x 14"D x 39 ³ / ₄ "H | HLPLDH66 | \$324 | \$324 |
| 2 | Laminate Hutch Doors Pack of 2 Doors | HLPLDR66LM | \$40 | \$80 |
| TOTAL: | | | | \$1,822 |

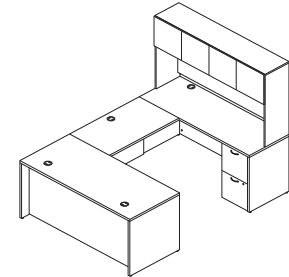

U-STATION (NON-HANDED)

66"W x 96"D

| QTY | DESCRIPTION | MODEL | LIST PRICE | PRICE EXTENSION |
|---------------|---|--------------|------------|-----------------|
| 1 | Peninsula 66"W x 30"D | HLPLPEN6630E | \$310 | \$310 |
| 1 | Credenza Shell 66"W x 24"D | HLPLCS6624 | \$279 | \$279 |
| 1 | Bridge 42"W x 24"D | HLPLB4224 | \$171 | \$171 |
| 1 | Pedestal - B/B/F 15"W x 20"D x 28"H | HLPLPSBBF | \$334 | \$334 |
| 1 | Hutch without Doors 66"W x 14"D x 39 ³ / ₄ "H | HLPLDH66 | \$324 | \$324 |
| 1 | Laminate Hutch Doors Pack of 2 Doors | HLPLDR66LM | \$40 | \$40 |
| TOTAL: | | | | \$1,458 |

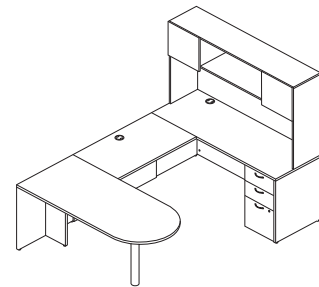

**U-STATION WITH PENINSULA
(NON-HANDED)**

66"W x 96"D

| QTY | DESCRIPTION | MODEL | LIST PRICE | PRICE EXTENSION |
|---------------|---|------------|------------|-----------------|
| 1 | Desk Shell 66"W x 30"D | HLPLDS6630 | \$300 | \$300 |
| 1 | Return Shell 42"W x 24"D | HLPLRS4224 | \$204 | \$204 |
| 1 | Pedestal - B/B/F 15"W x 20"D x 28"H | HLPLPSBBF | \$334 | \$334 |
| 1 | Pedestal - F/F 15"W x 20"D x 28"H | HLPLPSFF | \$334 | \$334 |
| 1 | Hutch without Doors 66"W x 14"D x 39 ³ / ₄ "H | HLPLDH66 | \$324 | \$324 |
| 2 | Glass Hutch Doors Pack of 2 Doors | HLPLDR66GS | \$141 | \$282 |
| TOTAL: | | | | \$1,778 |

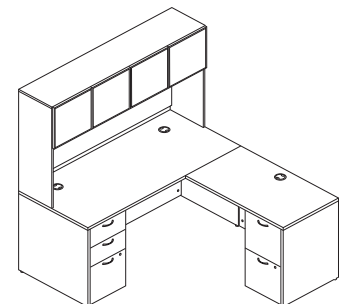

L-STATION (NON-HANDED)

66"W x 72"D

Components used are listed on pages 140-148. Order components individually. Other configurations are possible, including various sizes of some components.

| QTY | DESCRIPTION | MODEL | LIST PRICE | PRICE EXTENSION |
|---------------|---|-------------|----------------|-----------------|
| 1 | Bow Front Desk Shell 72"W x 36"D | HLPLDS7236B | \$379 | \$379 |
| 1 | Credenza Shell 72"W x 24"D | HLPLCS7224 | \$290 | \$290 |
| 1 | Pedestal - B/B/F 15"W x 20"D x 28"H | HLPLPSBBF | \$334 | \$334 |
| 1 | Pedestal - F/F 15"W x 20"D x 28"H | HLPLPSFF | \$334 | \$334 |
| 1 | Hutch without Doors 66"W x 14"D x 39 ³ / ₄ "H | HLPLDH66 | \$324 | \$324 |
| 2 | Laminate Hutch Doors Pack of 2 Doors | HLPLDR66LM | \$40 | \$80 |
| TOTAL: | | | \$1,741 | |

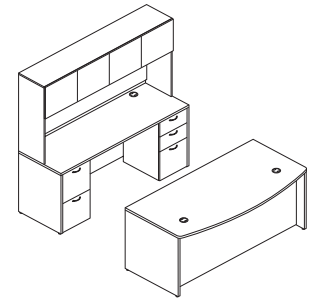

OFFICE SUITE
72"W x 96"D

| QTY | DESCRIPTION | MODEL | LIST PRICE | PRICE EXTENSION |
|---------------|--|----------------|----------------|-----------------|
| 1 | Reception Desk Shell 72"W x 30"D | HLPLRCPNDS7230 | \$436 | \$436 |
| 1 | Reception Return Shell 42"W x 25"D | HLPLRCPNRS4225 | \$263 | \$263 |
| 1 | Reception Laminate Transaction Top 72"W x 12"D | HLPLRCPNTPLM | \$93 | \$93 |
| 1 | Pedestal - B/B/F 15"W x 20"D x 28"H | HLPLPSBBF | \$334 | \$334 |
| TOTAL: | | | \$1,126 | |

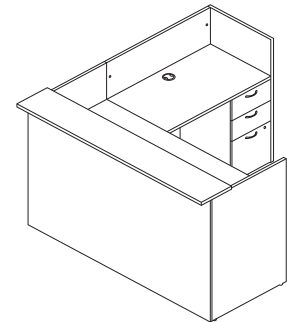

**RECEPTION STATION
(NON-HANDED)**
72"W x 72"D

| QTY | DESCRIPTION | MODEL | LIST PRICE | PRICE EXTENSION |
|---------------|--|-----------------|----------------|-----------------|
| 1 | Rectangle Conference Table Top 48"W x 120"L, 2-Piece | HLPLTBL4812ORCT | \$706 | \$706 |
| 1 | Conference Table Base For 120" Table Tops | HLPLTBL120BASE | \$114 | \$114 |
| 2 | Wardrobe 24"W x 24"D x 65"H | HLPLW2424 | \$854 | \$1,708 |
| 2 | Low Open Storage Credenza 36"W x 20"D x 21"H | HLPLCL3620S | \$261 | \$522 |
| 1 | Low Credenza Top 72"W x 20"D | HLPLCL7220TOP | \$137 | \$137 |
| TOTAL: | | | \$3,187 | |

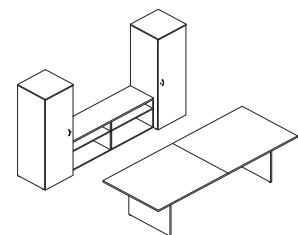

CONFERENCE ROOM
144"W x 180"D

MOD Typicals

Components used are listed on pages 140-148. Order components individually. Other configurations are possible, including various sizes of some components.

| QTY | DESCRIPTION | MODEL | LIST PRICE | PRICE EXTENSION |
|-----|---|---------------|------------|-----------------|
| 1 | Rectangle Worksurface 66"W x 30"D | HLPLRW6630 | \$192 | \$192 |
| 1 | Rectangle Worksurface 48"W x 24"D | HLPLRW4824 | \$146 | \$146 |
| 1 | Flat Bracket 24"D | HLPLFB24 | \$49 | \$49 |
| 2 | U-Leg Support 30"W | HLPLLEG30U | \$155 | \$310 |
| 1 | U-Leg Support 24"W | HLPLLEG24U | \$146 | \$146 |
| 1 | External Stiffener For 66"W Worksurfaces | HLPLXS66 | \$76 | \$76 |
| 1 | Mobile Pedestal - B/F 15"W x 20"D x 20"H | HLPLPMBF | \$292 | \$292 |
| 1 | Pedestal Cushion 15"W x 20"D | HLPLPSEAT1520 | \$93 | \$93 |

TOTAL: \$1,304

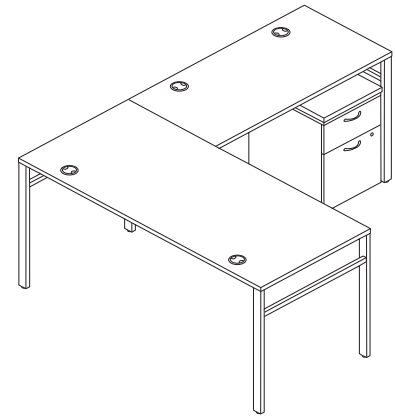

**L-STATION (NON-HANDED)
66"W x 78"D**

| QTY | DESCRIPTION | MODEL | LIST PRICE | PRICE EXTENSION |
|-----|---|---------------|------------|-----------------|
| 1 | Rectangle Worksurface 66"W x 30"D | HLPLRW6630 | \$192 | \$192 |
| 1 | U-Leg Support 30"W | HLPLLEG30U | \$155 | \$155 |
| 1 | External Stiffener For 66"W Worksurfaces | HLPLXS66 | \$76 | \$76 |
| 1 | Credenza Leg Support 7"H x 30"D | HLPLSL30 | \$102 | \$102 |
| 1 | Low 2-Drawer Credenza 30"W x 20"D x 21"H | HLPLCL3020BF | \$542 | \$542 |
| 1 | Low Open Storage Credenza 30"W x 20"D x 21"H | HLPLCL3020S | \$250 | \$250 |
| 1 | Low Credenza Top 60"W x 20"D | HLPLCL6020TOP | \$126 | \$126 |

TOTAL: \$1,443

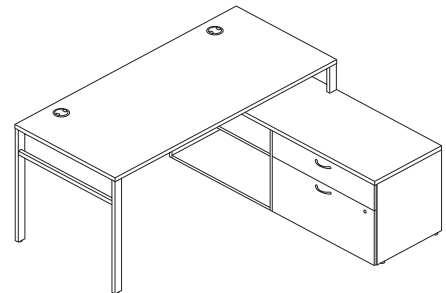

**L-STATION WITH CREDENZA
(NON-HANDED)
66"W x 60"D**

MOD Bundles Typicals

Traditional Mahogany
HLPLDS72PSTM1

Sepia Walnut
HLPLDS72PSSE1

Java Oak
HLPLDS72PSJA1

Russet Cherry
HLPLDS72PSRC1

Slate Teak
HLPLDS72PSSL1

| QTY | DESCRIPTION | MODEL | LIST PRICE | PRICE EXTENSION |
|---------------|------------------------|-------------------|--------------|-----------------|
| 1 | Rectangular Desk Shell | HLPLDS7230 | \$317 | \$317 |
| 1 | B/B/F Support Pedestal | HLPLPSBBF | \$334 | \$334 |
| 1 | F/F Support Pedestal | HLPLPSFF | \$334 | \$334 |
| TOTAL: | | | \$985 | |

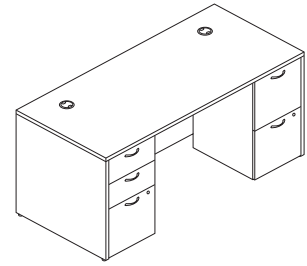

LAMINATE DESK WITH 2 PEDESTALS
72" W

Traditional Mahogany
HLPLDS66PSTM1

Sepia Walnut
HLPLDS66PSSE1

Java Oak
HLPLDS66PSJA1

Russet Cherry
HLPLDS66PSRC1

Slate Teak
HLPLDS66PSSL1

| QTY | DESCRIPTION | MODEL | LIST PRICE | PRICE EXTENSION |
|---------------|------------------------|-------------------|--------------|-----------------|
| 1 | Rectangular Desk Shell | HLPLDS6630 | \$300 | \$300 |
| 1 | B/B/F Support Pedestal | HLPLPSBBF | \$334 | \$334 |
| 1 | F/F Support Pedestal | HLPLPSFF | \$334 | \$334 |
| TOTAL: | | | \$968 | |

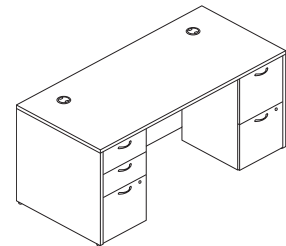

LAMINATE DESK WITH 2 PEDESTALS
66" W

Traditional Mahogany
HLPLDS60PSTM1

Sepia Walnut
HLPLDS60PSSE1

Java Oak
HLPLDS60PSJA1

Russet Cherry
HLPLDS60PSRC1

Slate Teak
HLPLDS60PSSL1

| QTY | DESCRIPTION | MODEL | LIST PRICE | PRICE EXTENSION |
|---------------|------------------------|-------------------|--------------|-----------------|
| 1 | Rectangular Desk Shell | HLPLDS6030 | \$274 | \$274 |
| 1 | B/B/F Support Pedestal | HLPLPSBBF | \$334 | \$334 |
| TOTAL: | | | \$608 | |

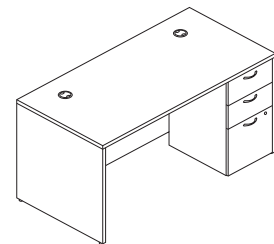

LAMINATE DESK WITH 1 PEDESTAL
60" W

Traditional Mahogany
HLPLDS48HBFM1

Sepia Walnut
HLPLDS48HBFSE1

Java Oak
HLPLDS48HBFJA1

Russet Cherry
HLPLDS48HBFRC1

Slate Teak
HLPLDS48HBFSL1

| QTY | DESCRIPTION | MODEL | LIST PRICE | PRICE EXTENSION |
|---------------|------------------------|-------------------|--------------|-----------------|
| 1 | Rectangular Desk Shell | HLPLDS4830 | \$263 | \$263 |
| 1 | B/F Hanging Pedestal | HLPLPHBF | \$245 | \$245 |
| TOTAL: | | | \$508 | |

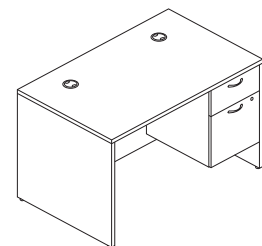

SMALL OFFICE DESK WITH 3/4 PEDESTAL
48" W

MOD Bundles Typicals

Black/Traditional Mahogany
HLPLW60LEG30UBLKPTM1

Black/Sepia Walnut
HLPLW60LEG30UBLKPSE1

Silver/Traditional Mahogany
HLPLW60LEG30USLVRTM1

Silver/Sepia Walnut
HLPLW60LEG30USLVRSE1

Black/Russet Cherry
HLPLW60LEG30UBLKPRC1

Black/Slate Teak
HLPLW60LEG30UBLKPSL1

Silver/Russet Cherry
HLPLW60LEG30USLVRR1

Silver/Slate Teak
HLPLW60LEG30USLVRSL1

Black/Java Oak
HLPLW60LEG30UBLKPJA1

Black/Simply White
HLPLW60LEG30UBLKPPW1

Silver/Java Oak
HLPLW60LEG30USLVRJA1

Silver/Simply White
HLPLW60LEG30USLVRPW1

| QTY | DESCRIPTION | MODEL | LIST PRICE | PRICE EXTENSION |
|---------------|-------------------------|-------------------|--------------|-----------------|
| 1 | Rectangular Worksurface | HLPLRW6030 | \$182 | \$182 |
| 1 | External Stiffener | HLPLXS60 | \$70 | \$70 |
| 2 | U-Leg Support 30"W | HLPLLEG30U | \$155 | \$310 |
| TOTAL: | | | \$562 | |

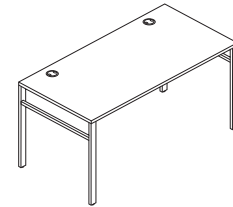

TABLE DESK WITH U-LEG
60"W x 30"D

Black/Traditional Mahogany
HLPLW66LEG30UBLKPTM1

Black/Sepia Walnut
HLPLW66LEG30UBLKPSE1

Silver/Traditional Mahogany
HLPLW66LEG30USLVRTM1

Silver/Sepia Walnut
HLPLW66LEG30USLVRSE1

Black/Russet Cherry
HLPLW66LEG30UBLKPRC1

Black/Slate Teak
HLPLW66LEG30UBLKPSL1

Silver/Russet Cherry
HLPLW66LEG30USLVRR1

Silver/Slate Teak
HLPLW66LEG30USLVRSL1

Black/Java Oak
HLPLW66LEG30UBLKPJA1

Black/Simply White
HLPLW66LEG30UBLKPPW1

Silver/Java Oak
HLPLW66LEG30USLVRJA1

Silver/Simply White
HLPLW66LEG30USLVRPW1

| QTY | DESCRIPTION | MODEL | LIST PRICE | PRICE EXTENSION |
|---------------|-------------------------|-------------------|--------------|-----------------|
| 1 | Rectangular Worksurface | HLPLRW6630 | \$192 | \$192 |
| 1 | External Stiffener | HLPLXS66 | \$76 | \$76 |
| 2 | U-Leg Support 30"W | HLPLLEG30U | \$155 | \$310 |
| TOTAL: | | | \$578 | |

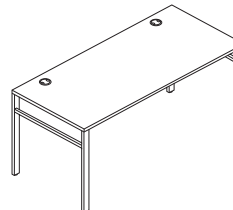

TABLE DESK WITH U-LEG
66"W x 30"D

MOD Bundles Typicals

Nickel/Traditional Mahogany
HLPLRW6024CONHATTM1

Nickel/Sepia Walnut
HLPLRW6024CONHATSE1

Nickel/Russet Cherry
HLPLRW6024CONHATRC1

Nickel/Slate Teak
HLPLRW6024CONHATSL1

Nickel/Java Oak
HLPLRW6024CONHATJA1

Nickel/Simply White
HLPLRW6024CONHATPW1

| QTY | DESCRIPTION | MODEL | LIST PRICE | PRICE EXTENSION |
|---------------|---------------------------------|-------------|------------|-----------------|
| 1 | Height Adjustable Base, 2-Stage | HHABETA2S2L | \$728 | \$728 |
| 1 | Rectangular Worksurface | HLPLRW6024 | \$150 | \$150 |
| TOTAL: | | | | \$878 |

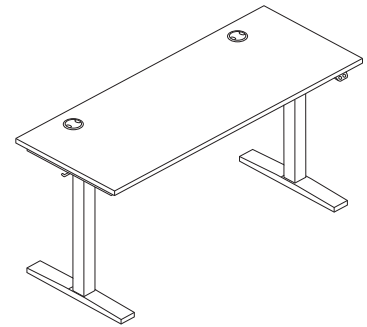

CONSUMER HEIGHT ADJUSTABLE TABLE
60"W x 24"D

Nickel/Traditional Mahogany
HLPLRW6030CONHATTM1

Nickel/Sepia Walnut
HLPLRW6030CONHATSE1

Nickel/Russet Cherry
HLPLRW6030CONHATRC1

Nickel/Slate Teak
HLPLRW6030CONHATSL1

Nickel/Java Oak
HLPLRW6030CONHATJA1

Nickel/Simply White
HLPLRW6030CONHATPW1

| QTY | DESCRIPTION | MODEL | LIST PRICE | PRICE EXTENSION |
|---------------|---------------------------------|-------------|------------|-----------------|
| 1 | Height Adjustable Base, 2-Stage | HHABETA2S2L | \$728 | \$728 |
| 1 | Rectangular Worksurface | HLPLRW6030 | \$182 | \$182 |
| TOTAL: | | | | \$910 |

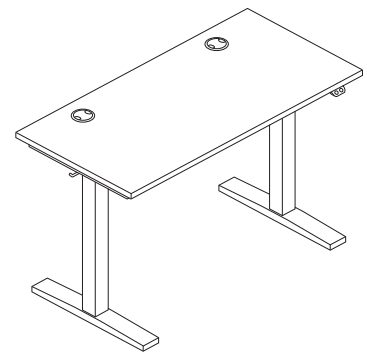

CONSUMER HEIGHT ADJUSTABLE TABLE
60"W x 30"D

Nickel/Traditional Mahogany
HLPLRW4824CONHATTM1

Nickel/Sepia Walnut
HLPLRW4824CONHATSE1

Nickel/Russet Cherry
HLPLRW4824CONHATRC1

Nickel/Slate Teak
HLPLRW4824CONHATSL1

Nickel/Java Oak
HLPLRW4824CONHATJA1

Nickel/Simply White
HLPLRW4824CONHATPW1

| QTY | DESCRIPTION | MODEL | LIST PRICE | PRICE EXTENSION |
|---------------|---------------------------------|-------------|------------|-----------------|
| 1 | Height Adjustable Base, 2-Stage | HHABETA2S2L | \$728 | \$728 |
| 1 | Rectangular Worksurface | HLPLRW4824 | \$146 | \$146 |
| TOTAL: | | | | \$874 |

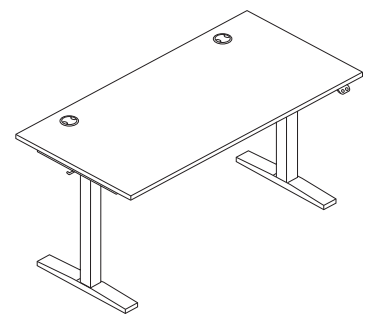

CONSUMER HEIGHT ADJUSTABLE TABLE
48"W x 24"D

MOD

Laminate Modular Components

OPEN MARKET



Icon Legend on page 19

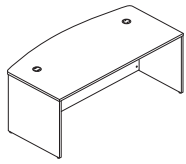

HLPLDS7236B shown

DESCRIPTION**Desk Shell**

72"W x 36"/30"D x 29"H, Bow Top
 72"W x 36"D x 29"H, Rectangle Top
 72"W x 30"D x 29"H, Rectangle Top
 66"W x 30"D x 29"H, Rectangle Top
 60"W x 30"D x 29"H, Rectangle Top
 48"W x 30"D x 29"H, Rectangle Top

MODEL**SHIP WEIGHT****CUBE****LIST PRICE**

| | | | |
|--------------------|-----|-----|--------------|
| HLPLDS7236B | 149 | 6.6 | \$379 |
| HLPLDS7236 | 149 | 6.6 | \$323 |
| HLPLDS7230 | 149 | 5.6 | \$317 |
| HLPLDS6630 | 116 | 5.1 | \$300 |
| HLPLDS6030 | 111 | 4.7 | \$274 |
| HLPLDS4830 | 75 | 4.7 | \$263 |

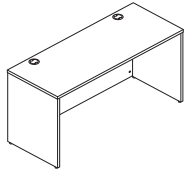
**Credenza Shell**

72"W x 24"D x 29"H
 66"W x 24"D x 29"H
 60"W x 24"D x 29"H
 48"W x 24"D x 29"H

| | | | |
|-------------------|-----|-----|--------------|
| HLPLCS7224 | 108 | 5.3 | \$290 |
| HLPLCS6624 | 96 | 4.8 | \$279 |
| HLPLCS6024 | 96 | 4.4 | \$258 |
| HLPLCS4824 | 75 | 3.7 | \$253 |

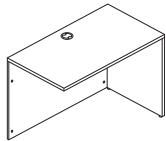
**Return Shell**

48"W x 24"D x 29"H
 42"W x 24"D x 29"H
 36"W x 24"D x 29"H

| | | | |
|-------------------|----|-----|--------------|
| HLPLRS4824 | 66 | 4.2 | \$214 |
| HLPLRS4224 | 60 | 4.2 | \$204 |
| HLPLRS3624 | 54 | 2.8 | \$169 |

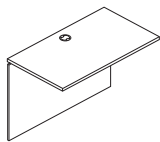
**Bridge**

48"W x 24"D x 29"H
 42"W x 24"D x 29"H
 36"W x 24"D x 29"H

| | | | |
|------------------|----|-----|--------------|
| HLPLB4824 | 53 | 4.2 | \$173 |
| HLPLB4224 | 46 | 4.2 | \$171 |
| HLPLB3624 | 40 | 3.7 | \$144 |

NOTES:

- Scratch- and stain-resistant thermal-fused laminate surfaces.
- Durable 1" thick tops and end panels.
- Full height modesty panels.
- Desk, Credenza, Return Shells, and Bridge assemble quickly and easily.
- Desks, Credenzas, Return Shells, and Bridges come standard with 3" round Black grommets.
- Adjustable floor leveling glides provide 3/4" of adjustment.
- **HON 5-Year Limited Warranty.**

HOW TO SPECIFY

| | |
|----------------------------|----------------------------------|
| Select Model Number | Select Woodgrain Laminate |
| | See page 132 |
| HLPLDS6030 | LSL1 |

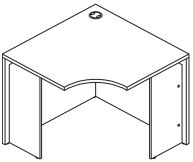
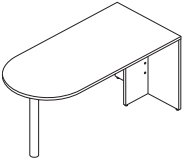

MOD Laminate Modular Components

| | DESCRIPTION | MODEL | SHIP WEIGHT | CUBE | LIST PRICE |
|---|---|---------------------|-------------|------|--------------|
|  | Corner Shell 36"W x 36"D x 29"H 30"W x 30"D x 29"H | HLPLCS36 | 114 | 5.3 | \$273 |
| | | HLPLCS30 | 93 | 3.2 | \$246 |
|  | Peninsula w/End Panel 72"W x 36"D x 29½"H 66"W x 30"D x 29½"H ⓘ Peninsula must be ganged to another unit, return, or bridge. ⓘ Support column available in Black only. Specify: Model.Woodgrain Laminate.Paint SPECIFYING EXAMPLE: HLPLPEN6630E.LSL1.BLKP | HLPLPEN7236E | 124 | 7.1 | \$349 |
| | | HLPLPEN6630E | 117 | 6.6 | \$310 |

NOTES:

- Scratch- and stain-resistant thermal-fused laminate surfaces.
- Durable 1" thick tops and end panels.
- Full height modesty panels.
- Corner Shells and Peninsula assemble quickly and easily.
- Corner Shells come standard with 3" round Black grommets.
- Adjustable floor leveling glides provide ¾" of adjustment.
- **HON 5-Year Limited Warranty.**

HOW TO SPECIFY

| | | |
|---|---|--|
| <p>Select Model Number</p> <p>HLPLPEN7236E .</p> | <p>Select Woodgrain Laminate</p> <p>See page 132</p> <p>LSL1 .</p> | <p>Select Paint Color</p> <p><i>Specify for new peninsula models only</i></p> <p>P Black</p> <p>P</p> |
|---|---|--|

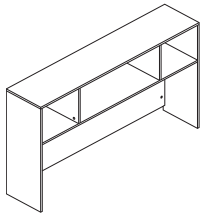
**DESCRIPTION****Hutch without Doors**

72"W x 14"D x 39³/₄"H
66"W x 14"D x 39³/₄"H
60"W x 14"D x 39³/₄"H

NOTES: Full back with gap at bottom for wire management.
Specify: Model.Woodgrain Laminate

! Hutch and Wall Mounted Storage units are sold without doors. 2 Doors or 4 Doors can be added to 72"W, 66"W, and 60"W units. 48"W Wall Mounted Storage Doors are sold in packages of 3 only.

SPECIFYING EXAMPLE: HLPLDH66.LSL1

MODEL**SHIP WEIGHT****CUBE****LIST PRICE**

| | | | |
|-----------------|-----|-----|--------------|
| HLPLDH72 | 106 | 7.1 | \$340 |
| HLPLDH66 | 99 | 7.2 | \$324 |
| HLPLDH60 | 92 | 5.3 | \$315 |

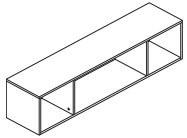
**Wall Mounted Storage without Doors**

72"W x 14"D x 13¹/₂"H
66"W x 14"D x 13¹/₂"H
60"W x 14"D x 13¹/₂"H
48"W x 14"D x 13¹/₂"H

! Hutch and Wall Mounted Storage units are sold without doors. 2 Doors or 4 Doors can be added to 72"W, 66"W, and 60"W units. 48"W Wall Mounted Storage Doors are sold in packages of 3 only.

| | | | |
|------------------|----|-----|--------------|
| HLPLWMH72 | 66 | 3.1 | \$404 |
| HLPLWMH66 | 62 | 3.6 | \$387 |
| HLPLWMH60 | 57 | 3.0 | \$379 |
| HLPLWMH48 | 48 | 2.5 | \$363 |

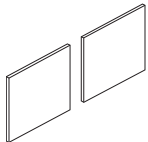
**Laminate Doors for Hutch and Wall Mounted Storage**

2 Pack, for HLPLDH72 and HLPLWMH72
2 Pack, for HLPLDH66 and HLPLWMH66
2 Pack, for HLPLDH60 and HLPLWMH60
3 Pack, for HLPLWMH48

| | | | |
|-------------------|----|-----|-------------|
| HLPLDR72LM | 12 | 0.8 | \$40 |
| HLPLDR66LM | 12 | 0.8 | \$40 |
| HLPLDR60LM | 12 | 0.8 | \$40 |
| HLPLDR48LM | 17 | 0.8 | \$59 |

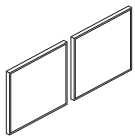
**Glass Doors for Hutch and Wall Mounted Storage**

2 Pack, for HLPLDH72 and HLPLWMH72
2 Pack, for HLPLDH66 and HLPLWMH66
2 Pack, for HLPLDH60 and HLPLWMH60
3 Pack, for HLPLWMH48

| | | | |
|-------------------|----|-----|--------------|
| HLPLDR72GS | 9 | 0.8 | \$141 |
| HLPLDR66GS | 9 | 0.8 | \$141 |
| HLPLDR60GS | 9 | 0.8 | \$141 |
| HLPLDR48GS | 13 | 0.8 | \$214 |

NOTES: No specification needed.

SPECIFYING EXAMPLE: HLPLDR66GS

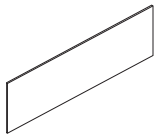
**Tackboards**

72"W x 18"H
66"W x 18"H
60"W x 18"H
48"W x 18"H

| | | | |
|-------------------|----|-----|--------------|
| HLPLTACK72 | 12 | 2.4 | \$125 |
| HLPLTACK66 | 12 | 2.2 | \$119 |
| HLPLTACK60 | 10 | 2.1 | \$114 |
| HLPLTACK48 | 8 | 1.7 | \$103 |

Specify: Model.Fabric

SPECIFYING EXAMPLE: HLPLTACK66.CN02

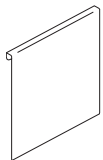
**Markerboard**

12"W x 12"H

| | | | |
|-------------------|---|-----|-------------|
| HLPLDR12MB | 3 | 0.6 | \$70 |
|-------------------|---|-----|-------------|

NOTES: No specification needed. Markerboard is designed to fit over the top of the laminate doors for hutches to create a writable/movable surface.

SPECIFYING EXAMPLE: HLPLDR12MB

NOTES:

- Scratch- and stain-resistant thermal-fused laminate surfaces.
- Durable ⁵/₈" thick tops and end panels.
- 72"W, 66"W, and 60"W hutches include fully enclosed back.
- Hutches and Wall Mounted Storage assemble quickly and easily.
- **HON 5-Year Limited Warranty.**

HOW TO SPECIFY

Select
Model Number

HLPLWMH66

Select
Laminate

See page 132

LSL1

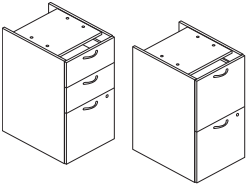
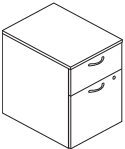

| | DESCRIPTION | MODEL | SHIP WEIGHT | CUBE | LIST PRICE |
|---|---|--|----------------------|-------------------|--|
|  | Support Pedestal 15"W x 20"D x 28"H, Box/Box/File 15"W x 20"D x 28"H, File/File NOTES: Optional Pulls available, see below. ⓘ Top is unfinished. Not to be used freestanding. | HLPLPSBBF HLPLPSFF | 81.0 79.0 | 7.4 7.4 | \$334 \$334 |
| | Hanging Pedestal 15"W x 20"D x 20"H, Box/File NOTES: Optional Pulls available, see below. ⓘ Top is unfinished. Not to be used freestanding. ⓘ Hanging Pedestal is designed to attach to the underside of the worksurface and is non-handed (can be assembled on left or right side). | HLPLPHBF | 63.0 | 5.8 | \$245 |
|  HLPLPMBF shown | Mobile Pedestal 15"W x 20"D x 28"H, Box/Box/File 15"W x 20"D x 28"H, File/File 15"W x 20"D x 20"H, Box/File NOTES: Optional Pulls available, see below. | HLPLPMBBF HLPLPMFF HLPLPMBF | 81.0 79.0 63.0 | 7.4 7.4 5.8 | \$412 \$412 \$292 |
| | Pedestal Cushion 15"W x 20"D Specify: Model.Fabric SPECIFYING EXAMPLE: HLPLPSEAT1520.CN02 | HLPLPSEAT1520 | 6.0 | 1.1 | \$93 |
| | Field Installed Contemporary Pull — 2-pack Silver NOTES: For use on Lateral Files, Pedestals, Wardrobe, and 2-Drawer Low Credenza. ⓘ Silver finish only, no specification needed. | HBLPCONTEMP | 0.4 ⓘ | 0.1 | \$13 |
| Field Installed Bridge Pull — 2-pack Silver NOTES: For use on Lateral Files, Pedestals, Wardrobe, and 2-Drawer Low Credenza. ⓘ Polished finish only, no specification needed. | HBLPBRIDGE | 0.4 ⓘ | 0.1 | \$13 | |
| Field Installed Classic Pull — 2-pack Black NOTES: For use on Lateral Files, Pedestals, Wardrobe, and 2-Drawer Low Credenza. ⓘ Black finish only, no specification needed. | HBLPCLASSIC | 0.4 ⓘ | 0.1 | \$13 | |

NOTES:

- Pedestals ship assembled.
- Support Pedestals are designed to be used under a desk, credenza, or return shell.
- Drawers operate on full extension, ball-bearing suspensions to ensure smooth, quiet, and long-lasting operation.
- Pedestals come standard with Arch pull in Silver finish.
- **HON 5-Year Limited Warranty.**

HOW TO SPECIFY

| | |
|--|--|
| Select Model Number H L P L P S B B F | Select Laminate See page 132 L S L 1 |
|--|--|

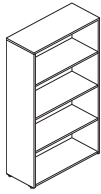

HLPLBC3013B5 shown

DESCRIPTION**Bookcase**

30"W x 13"D x 65"H, 5-Shelf, 3 Adjustable Shelves, 1 Fixed Shelf
 30"W x 13"D x 53"H, 4-Shelf, 2 Adjustable Shelves, 1 Fixed Shelf
 30"W x 13"D x 29"H, 2-Shelf, 1 Fixed Shelf

MODEL

HLPLBC3013B5
HLPLBC3013B4
HLPLBC3013B2

SHIP WEIGHT

137
 112
 63

CUBE

6.1
 5.2
 3.2

LIST PRICE

\$329
\$236
\$162

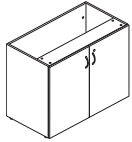
**Storage Cabinet**

36"W x 20"D x 29"H

HLPLSC3620

76

15.7

\$382

NOTES: Optional Pulls available, see page 143.

! Top is unfinished, not to be used freestanding. To convert to a freestanding cabinet, order model HLPLCL3620TOP, see page 146.

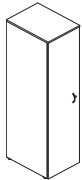
**Wardrobe**

24"W x 24"D x 65"H
 18"W x 24"D x 65"H

HLPLW2424
HLPLW1824

99
 84

4.2
 4.2

\$854
\$559

NOTES: Optional Pulls available, see page 143. Non-handed door which can be installed in left- or right-hand configuration. Coat rod, fixed shelf, and lock included.

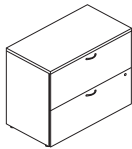

HLPLLF3620L2 shown

Lateral

36"W x 20"D x 53"H, 4-Drawer
 36"W x 20"D x 40"H, 3-Drawer
 36"W x 20"D x 29"H, 2-Drawer w/Removable Top

HLPLLF3620L4
HLPLLF3620L3
HLPLLF3620L2

193
 166
 145

27.4
 21.1
 15.7

\$951
\$841
\$541

NOTES: Optional Pulls available, see page 143.

! 2-Drawer Lateral, HLPLLF3620L2, available in all Laminate finishes including Simply White.

! Simply White is not an available option on either the 3-Drawer or 4-Drawer Laterals.

! To change the top of model HLPLLF3620L2 in order to make a two-tone unit, use model HLPLCL3620TOP, see page 146.

NOTES:

- Lateral files ship assembled.
- Drawers operate on full extension, ball-bearing suspensions to ensure smooth, quiet, and long-lasting operation.
- Hangrails are included in each file drawer for side-to-side legal filing, and for front-to-back letter and legal filing.
- Storage Cabinet, Wardrobe, and Lateral Files come standard with Arch pull in Silver finish.
- **HON 5-Year Limited Warranty.**

HOW TO SPECIFY

Select
Model Number

H L P L B C 3 0 1 3 B 5 .

Select
Woodgrain Laminate

See page 132

L S L 1

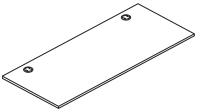
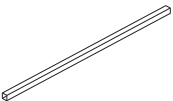
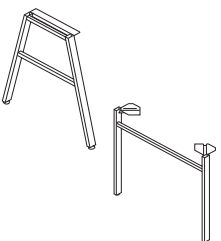
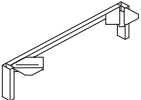
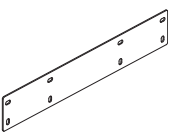

| | DESCRIPTION | MODEL | SHIP WEIGHT | CUBE | LIST PRICE |
|---|--|---|-------------|--------------|--------------|
|  | Rectangular Worksurface | | | | |
| | 72"W x 30"D | HLPLRW7230 | 110 | 6.0 | \$206 |
| | 72"W x 24"D | HLPLRW7224 | 89 | 4.9 | \$169 |
| | 66"W x 30"D | HLPLRW6630 | 101 | 5.5 | \$192 |
| | 66"W x 24"D | HLPLRW6624 | 82 | 4.5 | \$158 |
| | 60"W x 30"D | HLPLRW6030 | 92 | 5.0 | \$182 |
| | 60"W x 24"D | HLPLRW6024 | 75 | 4.1 | \$150 |
| | 48"W x 30"D | HLPLRW4830 | 75 | 4.1 | \$173 |
| | 48"W x 24"D | HLPLRW4824 | 61 | 3.4 | \$146 |
| | | Specify: Model.Laminate SPECIFYING EXAMPLE: HLPLRW6630.LSL1 | | | |
|  | External Stiffener | | | | |
| | For 72"W Worksurfaces | HLPLXS72 | 7 | 0.7 | \$81 |
| | For 66"W Worksurfaces | HLPLXS66 | 7 | 0.6 | \$76 |
| | For 60"W Worksurfaces | HLPLXS60 | 6 | 0.6 | \$70 |
| | Available in Graphite paint only. SPECIFYING EXAMPLE: HLPLXS66.BLKP | | | | |
|  | A-Leg Support | | | | |
| | 30"W Angled Leg | HLPLLEG30A | 16 | 5.1 | \$155 |
| | 24"W Angled Leg | HLPLLEG24A | 14 | 3.7 | \$146 |
| | NOTES: A-Leg will have adjustable floor leveling glides which provide 2" of adjustment. | | | | |
| | U-Leg Support | | | | |
| | 30"W U-Leg | HLPLLEG30U | 17 | 5.1 | \$155 |
| 24"W U-Leg | HLPLLEG24U | 15 | 3.7 | \$146 | |
| | NOTES: U-Leg will have adjustable floor leveling glides which provide 3" of adjustment. | | | | |
|  | Credenza Leg Support | | | | |
| | 7"H x 30"D Support Leg | HLPLSL30 | 6 | 1.0 | \$102 |
| | 7"H x 24"D Support Leg | HLPLSL24 | 5 | 1.0 | \$93 |
| | Overhead Support Leg | | | | |
| 23"H, Pack of 2 | HLPLOS23 | 13 | 1.1 | \$146 | |
| 10½"H, Pack of 2 | HLPLOS10 | 9 | 0.8 | \$114 | |
|  | Flat Bracket | | | | |
| | 24"D Bracket | HLPLFB24 | 3 | 0.6 | \$49 |
| | Available in Graphite paint only, no paint selection. SPECIFYING EXAMPLE: HLPLFB24 | | | | |

NOTES:

- Scratch- and stain-resistant thermal-fused laminate surfaces.
- Durable 1" thick tops.
- Worksurfaces come standard with 3" round Black grommets.
- **HON 5-Year Limited Warranty.**

HOW TO SPECIFY

| | |
|----------------------------|---|
| <p>Select Model Number</p> | <p>Select Paint Color</p> <p>See page 132</p> |
| <p>HLPLLEG30A.</p> | <p>BLKP</p> |

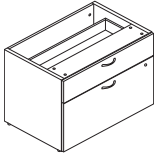
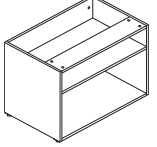
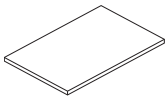
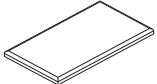

| | DESCRIPTION | MODEL | SHIP WEIGHT | CUBE | LIST PRICE |
|--|--|--|-------------|--------------|------------------------------|
|  | Low Credenza, 2 Drawers, Personal Cabinet, No Top | | | | |
| | 36"W x 20"D x 21"H 30"W x 20"D x 21"H | HLPLCL3620BF HLPLCL3020BF | 113 80 | 11.8 10.1 | \$554 \$542 |
| | NOTES: Optional Pulls available, see page 143. Unit ships fully assembled. Two low credenza units (2 drawer or Open Storage) can be combined using 1 top to create 60", 66", or 72" low credenzas. ! Top is unfinished, not to be used freestanding. Use with low credenza tops below to create a finished credenza. | | | | |
|  | Low Credenza, 2 Open Shelves, Open Storage Cabinet, No Top | | | | |
| | 36"W x 20"D x 21"H 30"W x 20"D x 21"H | HLPLCL3620S HLPLCL3020S | 63 48 | 3.0 2.5 | \$261 \$250 |
| | NOTES: Unit ships flat packed; assembly required. Two low credenza units (2 drawer or Open Storage) can be combined using 1 top to create 60", 66", or 72" low credenzas. ! Top is unfinished, cannot be used without a top. Use with low credenza tops below to create a finished credenza. | | | | |
|  | Low Credenza Cabinet Top | | | | |
| | 72"W x 20"D | HLPLCL7220TOP | 74 | 4.2 | \$137 |
| | 66"W x 20"D | HLPLCL6620TOP | 68 | 3.9 | \$135 |
| | 60"W x 20"D | HLPLCL6020TOP | 63 | 3.5 | \$126 |
| | 36"W x 20"D | HLPLCL3620TOP | 37 | 2.2 | \$88 |
| | 30"W x 20"D | HLPLCL3020TOP | 30 | 1.9 | \$81 |
|  | Low Credenza Cushion | | | | |
| | 36"W x 20"D 30"W x 20"D | HLPLCSEAT3620 HLPLCSEAT3020 | 11 9 | 2.2 1.9 | \$188 \$193 |
| | Specify: Model.Fabric SPECIFYING EXAMPLE: HLPLCSEAT3620.CN02 | | | | |

NOTES:

- Scratch- and stain-resistant thermal-fused laminate surfaces.
- Durable 1" thick tops.
- Low credenzas ship assembled.
- Drawers operate on full extension, ball-bearing suspensions to ensure smooth, quiet, and long-lasting operation.
- Hangrails are included in each file drawer for side-to-side legal filing, and for front-to-back letter and legal filing.
- Low Credenza, 2 Drawer comes standard with Arch pull in Silver finish.
- **HON 5-Year Limited Warranty.**

! Top must be specified with low credenza when using a cushion.

HOW TO SPECIFY

| | |
|----------------------------|------------------------|
| Select Model Number | Select Laminate |
| HLPLCL3620BF | See page 132 |
| LSL1 | |

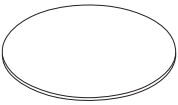
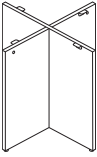
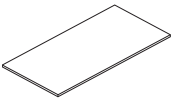
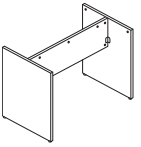

Conference Table Modular Components

| | DESCRIPTION | MODEL | SHIP WEIGHT | CUBE | LIST PRICE |
|---|---|------------------------|-------------|------|--------------|
|  | Round Conference Table Tops | | | | |
| | 48" Round Top | HLPLTBL48RND | 63 | 6.5 | \$217 |
| | 42" Round Top | HLPLTBL42RND | 50 | 5.1 | \$211 |
| | 36" Round Top | HLPLTBL36RND | 39 | 3.8 | \$173 |
|  | Round Conference Table Bases | | | | |
| | X-Base for 48" Table Tops | HLPLTBL48BASE | 45 | 3.2 | \$91 |
| | X-Base for 42" Table Tops | HLPLTBL42BASE | 42 | 3.2 | \$87 |
| | X-Base for 36" Table Tops | HLPLTBL36BASE | 36 | 2.5 | \$84 |
|  | Rectangle Conference Table Tops | | | | |
| | 48"W x 120"L Rectangular Top, 2-Piece | HLPLTBL48120RCT | 293 | 7.8 | \$706 |
| | 42"W x 96"L Rectangular Top | HLPLTBL4296RCT | 205 | 10.7 | \$486 |
| | 36"W x 72"L Rectangular Top | HLPLTBL3672RCT | 132 | 7.1 | \$287 |
|  | Rectangle Conference Table Bases | | | | |
| | Slab Base for 120" Table Tops | HLPLTBL120BASE | 86 | 4.2 | \$114 |
| | Slab Base for 96" Table Tops | HLPLTBL96BASE | 64 | 5.1 | \$109 |
| | Slab Base for 72" Table Tops | HLPLTBL72BASE | 48 | 3.0 | \$103 |

NOTES:

- Scratch- and stain-resistant thermal-fused laminate surfaces.
- Durable 1" thick tops and support legs.
- **HON 5-Year Limited Warranty.**

HOW TO SPECIFY

| | |
|--|--|
| <p>Select Model Number</p> <p>HLPLTBL42RND .</p> | <p>Select Laminate</p> <p>See page 132</p> <p>LSL1</p> |
|--|--|

MOD

Reception Modular Components

OPEN MARKET

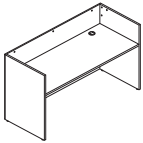
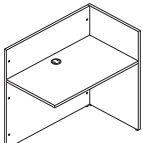
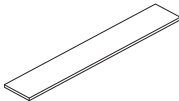

Icon Legend on page 19

| | DESCRIPTION | MODEL | SHIP WEIGHT | CUBE | LIST PRICE |
|--|---|-----------------------|-------------|------|--------------|
|  | Reception Desk Shell 72"W x 30"D x 41"H | HLPLRCPNDS7230 | 182 | 8.3 | \$436 |
|  | Reception Return Shell 42"W x 25"D x 41"H | HLPLRCPNRS4225 | 110 | 5.1 | \$263 |
|  | Transaction Tops 72"W x 12"D Laminate | HLPLRCNTPLM | 45 | 3.5 | \$93 |
| | 72"W x 12"D Frosted Glass | HLPLRCNTPGS | 35 | 3.2 | \$327 |
| | <p>ⓘ Laminate Transaction Top, HLPLRCNTPLM, available in all Laminate finishes including Simply White.</p> <p>ⓘ No selection for Glass Transaction Top, only one finish option.</p> | | | | |

NOTES:

- Scratch- and stain-resistant thermal-fused laminate surfaces.
- Durable 1" thick tops and end panels.
- Adjustable floor leveling glides provide 3/4" of adjustment.
- Reception stations assemble quickly and easily.
- 3" round Black grommet(s) in tops of desks to route cords.
- **HON 5-Year Limited Warranty.**

HOW TO SPECIFY

| | |
|------------------------|------------------------------|
| Select Model Number | Select Woodgrain Laminate |
| HLPLRCPNDS7230 | See page 132 |
| LSL1 | |



Valido® shown with Preside® Conference Table, HON® Occasional Tables, Flock® and Ignition® seating.

VALIDO®

Valido knows how to make them. Impeccable design. Quality craftsmanship. A tailored, signature style that lasts. With precision-machined edges and more than 100 different surface combinations, Valido lets you create a custom-built look with an executive edge. And thanks to a variety of flexible component options — plus high-quality laminate that resists scratches, stains, spills and wear — Valido is the very definition of form meeting function.



FEATURES

- Formal 1½-thick worksurfaces are finished with an elegant, ribbon-edge detail.
- Multiple storage options let you create spaces that work the way you do.
- Valido components are designed to fit, form and grow into every area and any space.
- Metal-to-metal fastening system for precise fit and unsurpassed durability.
- Available in durable mix-and-match laminates, including woodgrain, solid, and pattern colors.
- Four decorative handle options to choose from.

VALIDO® ORDERING INFORMATION

LAMINATE FINISHES AVAILABILITY

L1 LAMINATES CODES

Woodgrain

- ◆ Bourbon Cherry **HH**
- ◆ Cognac **COGNCOGN**
- ◆ Florence Walnut **LFWILFW1**
- ◆ Harvest **CC**
- ◆ Kingswood Walnut **LK1LK1I**
- ◆ Mahogany **NN**
- ◆ Mocha **MOCHMOCH**
- ◆ Natural Maple **DD**
- ◆ Pinnacle **PINCPINC**
- ◆ Shaker Cherry **FF**
- ◆ Sterling Ash **LSA1LSA1**

Solid

- ◆ Black **PP**
- ◆ Charcoal **SS**
- ◆ Designer White **LDWILDW1**

Patterned Top

- ◆ Grey Tigris * **L6(*)**
- ◆ Handspun Chestnut **LAHC**
- ◆ Handspun Dove **LAHD**
- ◆ Handspun Pearl **LAHP**
- ◆ Handspun Slate **LAHS**
- ◆ Sheer Mesh * **A5(*)**
- ◆ Silver Mesh **B9(*)**
- ◆ Canyon Zephyr * **K9(*)**
- ◆ Desert Zephyr * **K8(*)**

(* Patterned top laminates are available with the following base/edgebanding laminate selection: C, COGN, D, F, H, MOCH, N, P, PINC, S, DW, FW, KI, or SA. Edgebanding will match base laminate selected.

SPECIFYING EXAMPLE: H11592.L6N

The following Valido products are not available as two-tone and require only one color code:

- Modular pedestals — box/file, box/box/file, file/file, lateral file, multi file, and cabinet.

- ◆◆◆ For lead time information see page 19.
- * De-emphasized

Patterned Top

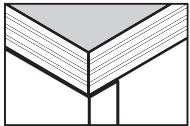

Edgeband Around Top / Laminate Base

- Edgebanding on patterned laminates matches the laminate base selected.
- LAMINATE DESKS
SPECIFY: Model Number.
Laminate
- EXAMPLE: H11596.NN
- WORKSURFACES
SPECIFY: Model Number.
Top Laminate
Edgeband
- All specifications in this publication are based on the latest product information available at the time of print.
- ! Tops with a patterned color are not available with a matching edgeband.

Edge Option:



Ribbon Edge "A"

Handle Options:



Sweep Designator
Black A
Satin Nickel C
4 7/8" W



Crescent Designator
Black D
Satin Nickel F
5" W

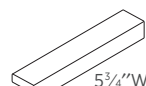

Linear
Black G
Matte Chrome J
5 3/4" W

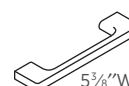

Arch
Black K
Matte Chrome M
5 3/8" W

TWO-TONE LAMINATE TOP / BASE

L1 LAMINATES CODES

Two-Tone Top/Base

- ◆ Black/Charcoal **PS**
- ◆ Black/Designer White ... **PLDW1**
- ◆ Bourbon Cherry/Black **HP**
- ◆ Bourbon Cherry/Charcoal ... **HS**
- ◆ Bourbon Cherry/Designer
White **HLDW1**
- ◆ Charcoal/Black **SP**
- ◆ Charcoal/Designer
White **SLDW1**
- ◆ Cognac/Black **COGNP**
- ◆ Cognac/Charcoal **COGNS**
- ◆ Cognac/Designer
White **COGNLDW1**
- ◆ Designer White/Black ... **LDW1P**
- ◆ Designer White/Bourbon
Cherry **LDW1H**
- ◆ Designer
White/Charcoal **LDW1S**
- ◆ Designer
White/Cognac **LDW1COGN**
- ◆ Designer
White/Harvest **LDW1C**
- ◆ Designer
White/Mahogany **LDW1N**
- ◆ Designer
White/Mocha **LDW1MOCH**
- ◆ Designer White/Natural
Maple **LDW1D**
- ◆ Designer
White/Pinnacle **LDW1PINC**
- ◆ Designer White/Shaker
Cherry **LDW1F**
- ◆ Florence Walnut/Black . **LFW1P**
- ◆ Florence
Walnut/Charcoal **LFW1S**

- ◆◆◆ For lead time information see page 19.

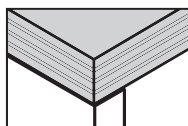

Laminate Base

- Two-tone laminates: Top and edgebanding are the same, base is different laminate color.
- Edgebanding on two-tone laminates matches top, base is a different laminate color.
 - A complete selection of Conference Room and Occasional Tables is shown in the Tables section in the 2021 Shared Spaces Pricer.
 - LAMINATE DESKS
SPECIFY: Model Number.
Laminate
 - EXAMPLE: H11596.HP
 - All specifications in this publication are based on the latest product information available at the time of print.

TWO-TONE LAMINATE TOP / BASE

continued

L1 LAMINATES CODES

Two-Tone Top/Base

- ◆ Florence Walnut/Designer
White **LFWILDW1**
- ◆ Harvest/Black **CP**
- ◆ Harvest/Charcoal **CS**
- ◆ Harvest/Designer
White **CLDW1**
- ◆ Kingswood
Walnut/Black **LK11P**
- ◆ Kingswood
Walnut/Charcoal **LK11S**
- ◆ Kingswood Walnut/Designer
White **LK11LDW1**
- ◆ Mahogany/Black **NP**
- ◆ Mahogany/Charcoal **NS**
- ◆ Mahogany/Designer
White **NLDW1**
- ◆ Mocha/Black **MOCHP**
- ◆ Mocha/Charcoal **MOCHS**
- ◆ Mocha/Designer
White **MOCHLDW1**
- ◆ Natural Maple/Black **DP**
- ◆ Natural Maple/Charcoal **DS**
- ◆ Natural Maple/Designer
White **DLDW1**
- ◆ Pinnacle/Black **PINCP**
- ◆ Pinnacle/Charcoal **PINCS**
- ◆ Pinnacle/Designer
White **PINCLDW1**
- ◆ Shaker Cherry/Black **FP**
- ◆ Shaker Cherry/Charcoal **FS**
- ◆ Shaker Cherry/Designer
White **FLDW1**
- ◆ Sterling Ash/Black **LSA1P**
- ◆ Sterling Ash/Charcoal **LSA1S**
- ◆ Sterling Ash/Designer
White **LSA1LDW1**



Icon Legend on page 19

Components used are listed on pages 154-176. Order components individually. Other configurations are possible, including various sizes of some components.

| QTY | DESCRIPTION | MODEL | LIST PRICE | PRICE EXTENSION |
|---------------|---|--------|----------------|-----------------|
| 1 | Double Pedestal Desk - 2/2 72"W x 36"D x 29½"H | H11593 | \$1,989 | \$1,989 |
| 1 | Credenza with Kneespace - 2/2 72"W x 24"D x 29½"H | H11543 | \$1,843 | \$1,843 |
| 1 | Stack-on Storage 72"W x 14⅝"D x 37½"H | H11534 | \$1,432 | \$1,432 |
| 2 | Vertical Paper Manager | HLVPM1 | \$351 | \$702 |
| TOTAL: | | | \$5,966 | |

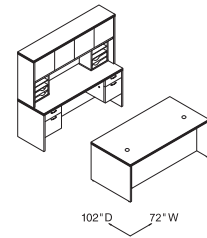

DESK/CREDENZA
72"W x 102"D

| QTY | DESCRIPTION | MODEL | LIST PRICE | PRICE EXTENSION |
|---------------|--|----------|-----------------|-----------------|
| 1 | Double Pedestal Bow Top Desk - 2/2 72"W x 36"D x 29½"H | H11595 | \$2,172 | \$2,172 |
| 1 | Credenza with Kneespace - 2/2 72"W x 24"D x 29½"H | H115900 | \$2,291 | \$2,291 |
| 1 | Stack-on Storage 72"W x 14⅝"D x 37½"H | H11534 | \$1,432 | \$1,432 |
| 1 | Personal Wardrobe/Storage Cabinet, Left 18"W x 24"D x 67"H | H115296L | \$1,970 | \$1,970 |
| 1 | Storage/File Cabinet, Right 18"W x 24"D x 67"H | H115297R | \$2,278 | \$2,278 |
| TOTAL: | | | \$10,143 | |

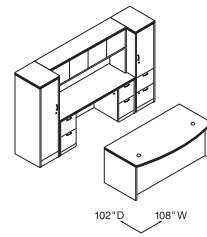

DESK/CREDENZA
108"W x 102"D

| QTY | DESCRIPTION | MODEL | LIST PRICE | PRICE EXTENSION |
|---------------|--|----------|----------------|-----------------|
| 1 | Single Pedestal Desk, Left - B/F 72"W x 36"D x 29½"H | H11586L | \$1,691 | \$1,691 |
| 1 | Return, Right - B/F 48"W x 24"D x 29½"H | H11515R | \$1,231 | \$1,231 |
| 1 | Stack-on Storage 48"W x 14⅝"D x 37½"H | H115323 | \$1,164 | \$1,164 |
| 1 | Square End Cap Bookshelf 24"W x 24"D x 29½"H | H115525R | \$834 | \$834 |
| TOTAL: | | | \$4,920 | |

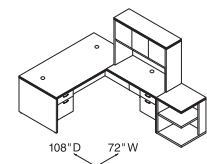

"L" WORKSTATION
72"W x 108"D

| QTY | DESCRIPTION | MODEL | LIST PRICE | PRICE EXTENSION |
|---------------|--|---------|----------------|-----------------|
| 1 | Single Pedestal Desk, Left - B/F 66"W x 30"D x 29½"H | H11584L | \$1,580 | \$1,580 |
| 1 | Return, Right - B/F 48"W x 24"D x 29½"H | H11515R | \$1,231 | \$1,231 |
| 1 | Stack-on Storage 78"W x 14⅝"D x 37½"H | H115327 | \$1,593 | \$1,593 |
| 1 | Vertical Paper Manager | HLVPM1 | \$351 | \$351 |
| 1 | End Cap Bookshelf 24"W x 24"D x 29½"H | H115520 | \$847 | \$847 |
| 1 | End Cap Bookshelf 15"W x 15"D x 37½"H | H115523 | \$749 | \$749 |
| TOTAL: | | | \$6,351 | |

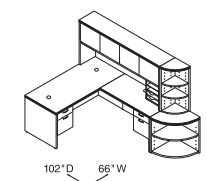

"L" WORKSTATION
66"W x 102"D



Components used are listed on pages 154-176. Order components individually. Other configurations are possible, including various sizes of some components.

| QTY | DESCRIPTION | MODEL | LIST PRICE | PRICE EXTENSION |
|---------------|--|---------|----------------|-----------------|
| 1 | Single Pedestal Desk, Right - B/F 72"W x 36"D x 29½"H | H11585R | \$1,691 | \$1,691 |
| 1 | Bridge 47"W x 24"D x 29½"H | H11570 | \$560 | \$560 |
| 1 | Credenza with 36" Lateral, Left 72"W x 24"D x 29½"H | H11548L | \$1,977 | \$1,977 |
| 1 | Stack-on Storage 72"W x 14⅝"D x 37½"H | H11534 | \$1,432 | \$1,432 |
| 1 | Storage Cabinet/Lateral File 36"W x 24"D x 67"H | H115293 | \$2,953 | \$2,953 |
| TOTAL: | | | \$8,613 | |

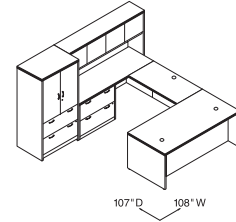

"U" WORKSTATION
108"W x 107"D

| QTY | DESCRIPTION | MODEL | LIST PRICE | PRICE EXTENSION |
|---------------|--|----------|----------------|-----------------|
| 1 | Single Full Pedestal Bow Front Desk 72"W x 36"D x 29½"H | H115893R | \$2,370 | \$2,370 |
| 1 | Bridge 42"W x 24"D x 29½"H | H11560 | \$536 | \$536 |
| 1 | Left Single Full Pedestal Credenza 72"W x 24"D x 29½"H | H115904L | \$1,885 | \$1,885 |
| 1 | Stack-on Storage 72"W x 14⅝"D x 37½"H | H11534 | \$1,432 | \$1,432 |
| 1 | Vertical Paper Manager | HLVPM1 | \$351 | \$351 |
| 1 | Personal Wardrobe/Storage Cabinet 36"W x 24"D x 67"H | H11530 | \$2,884 | \$2,884 |
| TOTAL: | | | \$9,458 | |

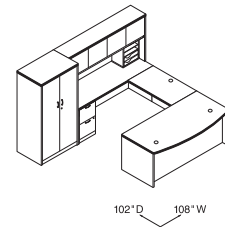

"U" WORKSTATION
108"W x 102"D

| QTY | DESCRIPTION | MODEL | LIST PRICE | PRICE EXTENSION |
|---------------|--|----------|----------------|-----------------|
| 1 | Single Pedestal Bow Front Desk, Right - B/F 72"W x 36"D x 29½"H | H11587R | \$1,914 | \$1,914 |
| 1 | Bridge 36"W x 24"D x 29½"H | H115599 | \$536 | \$536 |
| 1 | 36" Corner Unit | H115811 | \$1,000 | \$1,000 |
| 1 | Return, Left 42"W x 24"D x 29½"H | H11512L | \$1,217 | \$1,217 |
| 1 | Stack-on Storage 78"W x 14⅝"D x 37½"H | H115327 | \$1,593 | \$1,593 |
| 1 | Vertical Paper Manager | HLVPM1 | \$351 | \$351 |
| 1 | Personal Storage Tower 24"W x 24"D x 67"H | H115301R | \$2,884 | \$2,884 |
| TOTAL: | | | \$9,495 | |

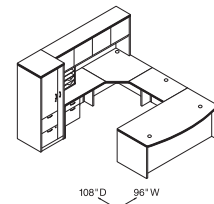

"U" WORKSTATION
102"W x 108"D

| QTY | DESCRIPTION | MODEL | LIST PRICE | PRICE EXTENSION |
|---------------|---|----------|----------------|-----------------|
| 1 | Extended Corner Unit, Left 24"D x 72"W x 36"D x 24"W x 29½"H | H115816L | \$1,450 | \$1,450 |
| 1 | Box/Box/File Mobile Pedestal 15⅝"W x 22¾"D x 28"H | H115102 | \$1,041 | \$1,041 |
| 1 | Stack-on Storage 72"W x 14⅝"D x 37½"H | H11534 | \$1,432 | \$1,432 |
| 1 | Vertical Paper Manager | HLVPM1 | \$351 | \$351 |
| 1 | Return Shell (with Full Modesty Panel) 48"W x 24"D x 29½"H | H11561 | \$764 | \$764 |
| 1 | File/File Mobile Pedestal 15⅝"W x 22¾"D x 28"H | H115104 | \$1,041 | \$1,041 |
| TOTAL: | | | \$6,079 | |

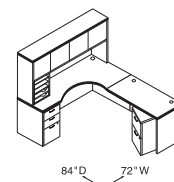

MODULAR "L" WORKSTATION
72"W x 84"D



Icon Legend on page 19

Components used are listed on pages 154-176. Order components individually. Other configurations are possible, including various sizes of some components.

| QTY | DESCRIPTION | MODEL | LIST PRICE | PRICE EXTENSION |
|---------------|---|----------|----------------|-----------------|
| 1 | Jetty Peninsula, Left 72"W x 42"/30"D x 29½"H | H115202L | \$1,546 | \$1,546 |
| 1 | File/File Mobile Pedestal 15⅝"W x 22¾"D x 28"H | H115104 | \$1,041 | \$1,041 |
| 1 | Return Shell 72"W x 24"D x 29½"H | H115686 | \$998 | \$998 |
| 1 | Multi File Pedestal 36"W x 20"D x 28"H | H11505 | \$1,559 | \$1,559 |
| 2 | Wall Mounted Storage Cabinet 42"W x 14⅝"D x 18⅞"H | H115382 | \$1,095 | \$2,190 |
| 1 | Wall Mounted Storage Cabinet 30"W x 14⅝"D x 18⅞"H | H115380 | \$967 | \$967 |
| 1 | End Cap Bookshelf 24"W x 24"D x 29½"H | H115520 | \$847 | \$847 |
| TOTAL: | | | \$9,148 | |

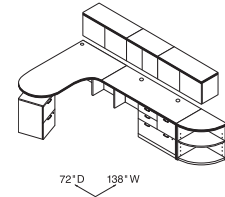

MODULAR "L" WORKSTATION
138"W x 72"D

| QTY | DESCRIPTION | MODEL | LIST PRICE | PRICE EXTENSION |
|---------------|---|----------|-----------------|-----------------|
| 1 | Storage/File Cabinet, Left 18"W x 24"D x 67"H | H115298L | \$2,278 | \$2,278 |
| 1 | Return Shell 72"W x 24"D x 29½"H | H115686 | \$998 | \$998 |
| 1 | File/File Modular Pedestal 15⅝"W x 22¾"D x 28"H | H11504 | \$851 | \$851 |
| 1 | Mobile Printer/Fax Cart 20"W x 19⅞"D x 14⅞"H | H105679 | \$451 | \$451 |
| 1 | Stack-on Storage 72"W x 14⅝"D x 37½"H | H11534 | \$1,432 | \$1,432 |
| 1 | Vertical Paper Manager | HLVPM1 | \$351 | \$351 |
| 1 | 36" Corner Unit | H115811 | \$1,000 | \$1,000 |
| 1 | Stack-on Storage 36"W x 14⅝"D x 37½"H | H115321 | \$960 | \$960 |
| 1 | Return Shell 60"W x 24"D x 29½"H | H115684 | \$933 | \$933 |
| 1 | Multi File Pedestal 36"W x 20"D x 28"H | H11505 | \$1,559 | \$1,559 |
| TOTAL: | | | \$10,813 | |

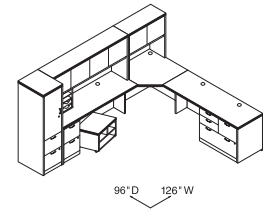

MODULAR "L" CORNER WORKSTATION
126"W x 96"D

| QTY | DESCRIPTION | MODEL | LIST PRICE | PRICE EXTENSION |
|---------------|---|----------|-----------------|-----------------|
| 1 | Boomerang Peninsula, Left 72"W x 42"/30"D x 29½"H | H115204L | \$1,546 | \$1,546 |
| 1 | Box/Box/File Mobile Pedestal 15⅝"W x 22¾"D x 28"H | H115102 | \$1,041 | \$1,041 |
| 1 | Bridge 30"W x 24"D x 29½"H | H115598 | \$536 | \$536 |
| 1 | Extended Corner Unit, Right 24"W x 36"D x 72"W x 24"D x 29½"H | H115815R | \$1,450 | \$1,450 |
| 1 | File/File Modular Pedestal 15⅝"W x 22¾"D x 28"H | H11504 | \$851 | \$851 |
| 1 | Stack-on Storage 72"W x 14⅝"D x 37½"H | H11534 | \$1,432 | \$1,432 |
| 1 | Storage/File Cabinet, Right 18"W x 24"D x 67"H | H115297R | \$2,278 | \$2,278 |
| 1 | End Cap Bookshelf 24"W x 24"D x 67"H | H115524 | \$1,345 | \$1,345 |
| TOTAL: | | | \$10,479 | |

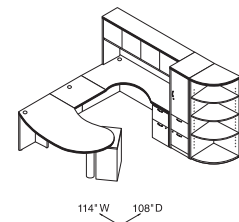

MODULAR "U" WORKSTATION
114"W x 108"D

VALIDO® Laminate Modular Desks

GSA SIN 33721



Icon Legend on page 19

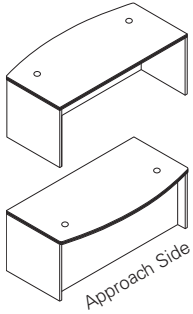

Model H11596 shown

DESCRIPTION

Desk Shell (with Full Modesty Panel)

- 72"W x 36"D x 29½"H, Bow Top (end panels 30"D)
- 72"W x 36"D x 29½"H, Rectangle Top
- 72"W x 30"D x 29½"H, Rectangle Top
- 66"W x 30"D x 29½"H, Rectangle Top
- 60"W x 30"D x 29½"H, Rectangle Top
- 48"W x 30"D x 29½"H, Rectangle Top (1 grommet)

INSIDE DIMENSIONS

FULL WIDTH OVERHANG

MODEL

SHIP WEIGHT

CUBE

LIST PRICE

| | | | | | |
|---------------|------|---------------|-----|-----|---------------|
| 69½"W x 24⅝"D | 10½" | H11596 | 218 | 5.8 | \$1184 |
| 69½"W x 24⅝"D | 10½" | H11594 | 239 | 5.8 | \$1134 |
| 69½"W x 24⅝"D | 4½" | H11592 | 206 | 6.6 | \$1058 |
| 63½"W x 24⅝"D | 4½" | H11579 | 194 | 4.5 | \$998 |
| 57½"W x 24⅝"D | 4½" | H11578 | 182 | 4.1 | \$956 |
| 45½"W x 24⅝"D | 4½" | H11598 | 154 | 4.0 | \$903 |

NOTES: See page 174 for optional center drawers.

NOTES:

- Non-handed desk, credenza, and return shells, combined with a variety of under-the-worksurface storage solutions, maximize office layout flexibility. Shells and pedestals can be reconfigured quickly and easily when user preferences or space needs change.
- Tops are abrasion- and stain-resistant laminate over extra-thick 1½" solid core high-performance particleboard; resists warping.
- "Ribbon" edge profile; shape is on all four sides.
- Full height modesty panels.
- Cord management grommets, for routing and hiding wires and cables, are located in the tops of desk and return shells.
- 3" round worksurface grommet can be replaced with optional Power Hub (model HGRMTAC) or Power/USB Hub (model HGRMTUSB2) to bring the ease of plug-and-play to the desktop. See page 178.
- Credenza shells have a cord pass-through grommet in the top center of the modesty panel.
- The narrow design of the kneespace clearance end panel kits replace full end panels to provide added kneespace.
- Adjustable hex leveling glides allow floor-standing furniture to be easily leveled; glides have ¾" adjustable range.
- For conference table options, see the Preside® table tops and bases in the Tables section in the 2021 Shared Spaces Pricer. Order edge option "K".
- See pages 157-158 for modular storage components.

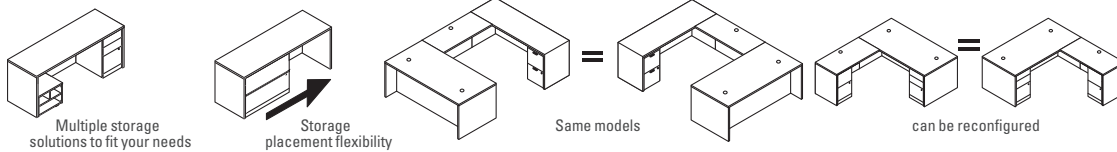



HOW TO SPECIFY

| | | |
|--|--|--|
| <p>Select Model Number</p> <p>H 1 1 5 9 6 .</p> | <p>Select Edge Profile</p> <p>See page 150</p> <p>A .</p> | <p>Select Laminate</p> <p>See page 150</p> <p>N N</p> |
|--|--|--|

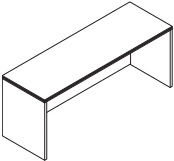
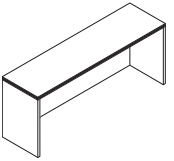
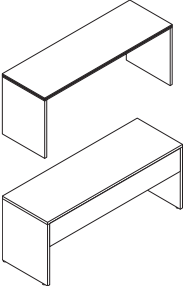

Icon Legend on page 19

VALIDO® Modular Credenzas

| | DESCRIPTION | INSIDE DIMENSIONS | MODEL | SHIP WEIGHT | CUBE | LIST PRICE |
|---|---|-------------------|-----------------|-------------|------|--------------|
|  Model H11541 shown | 24"D Credenza Shell (with Full Modesty Panel) | | | | | |
| | 72"W x 24"D x 29½"H | 69½"W x 22¾"D | H11541 | 169 | 4.5 | \$998 |
| | 66"W x 24"D x 29½"H | 63½"W x 22¾"D | H11542 | 159 | 4.2 | \$970 |
| | 60"W x 24"D x 29½"H | 57½"W x 22¾"D | H11564 | 148 | 3.8 | \$933 |
| | 48"W x 24"D x 29½"H | 45½"W x 22¾"D | H115692 | 135 | 2.8 | \$877 |
| | 42¼"W x 24"D x 29½"H | 39¾"W x 22¾"D | H115691 | 118 | 3.4 | \$834 |
| NOTES: Cord pass-through grommet in top center of modesty panel. See pages 166-167 for optional stack-on storage. | | | | | | |
|  | 20"D Credenza Shell (with Full Modesty Panel) | | | | | |
| | 72"W x 20"D x 29½"H | 69½"W x 18¾"D | H115581 | 154 | 5.3 | \$944 |
| | 66"W x 20"D x 29½"H | 63½"W x 18¾"D | H115582 | 145 | 4.8 | \$916 |
| | 60"W x 20"D x 29½"H | 57½"W x 18¾"D | H115583 | 135 | 4.4 | \$883 |
| NOTES: Cord pass-through grommet in top center of modesty panel. See pages 166-167 for optional stack-on storage. | | | | | | |
|  | 24"D Credenza Shell (with 10" Modesty Panel) | | | | | |
| | 72"W x 24"D x 29½"H | 69½"W x 22¾"D | H11541X | 162 | 5.0 | \$998 |
| | 66"W x 24"D x 29½"H | 63½"W x 22¾"D | H11542X | 124 | 4.0 | \$970 |
| | 60"W x 24"D x 29½"H | 57½"W x 22¾"D | H11564X | 120 | 4.0 | \$933 |
| | 48"W x 24"D x 29½"H | 45½"W x 22¾"D | H115692X | 107 | 4.0 | \$877 |
| | 42¼"W x 24"D x 29½"H | 39¾"W x 22¾"D | H115691X | 98 | 4.0 | \$834 |
| | 20"D Credenza Shell (with 10" Modesty Panel) | | | | | |
| | 72"W x 20"D x 29½"H | 69½"W x 18¾"D | H115581X | 124 | 4.6 | \$944 |
| | 66"W x 20"D x 29½"H | 63½"W x 18¾"D | H115582X | 117 | 4.2 | \$916 |
| | 60"W x 20"D x 29½"H | 57½"W x 18¾"D | H115583X | 110 | 3.8 | \$883 |
| NOTES: Makes reaching wall electrical outlets quick and easy. Provides more than 18" of clearance. See pages 166-167 for optional stack-on storage. | | | | | | |
|  Not available in two-tone laminate | Kneespace Clearance End Panel Kits (field installable) | | | | | |
| | 1⅞"W x 11¼"D x 28⅞"H | | H105098 | 13 | 0.9 | \$223 |
| For use at either end of Valido, 10500 or 10700 Series™ 24"D Credenza Shells (with full or 10" modesty panel) or non-pedestal end of single pedestal credenzas or credenzas with lateral files. | | | | | | |
| | 1⅞"W x 17¼"D x 28⅞"H | | H105099 | 11 | 0.8 | \$234 |
| For use at either end of Valido, 10500 or 10700 Series™ 30"D Desk Shells or non-pedestal end of 30"D single pedestal desks. | | | | | | |
| Kits include: (1) support panel; European fastening hardware; flat connector bracket; joint connector bolts with sleeve nuts (for ganging credenza to adjacent worksurface); and adjustable leveling glides. Allows conversion of units currently in the field. | | | | | | |
| NOTES: Can be used to connect up to three 24"D credenzas or 30"D desks in line (requires 4 kits). | | | | | | |
| ⚠ Not designed to be used freestanding. Not designed to be used with returns, 36"D desks or desk shells. | | | | | | |
| SPECIFYING EXAMPLE: H105098.N | | | | | | |

NOTES:

- Non-handed desk, credenza, and return shells, combined with a variety of under-the-worksurface storage solutions, maximize office layout flexibility. Shells and pedestals can be reconfigured quickly and easily when user preferences or space needs change.
- Tops are abrasion- and stain-resistant laminate over extra-thick 1½" solid core high-performance particleboard; resists warping.
- "Ribbon" edge profile; shape is on all four sides.
- Cord management grommets, for routing and hiding wires and cables, are located in the tops of desk and return shells.
- Credenza shells have a cord pass-through grommet in the top center of the modesty panel.
- The narrow design of the kneespace clearance end panel kits replace full end panels to provide added kneespace.
- Adjustable hex leveling glides allow floor-standing furniture to be easily leveled; glides have ¾" adjustable range.
- Credenza Shells available with Full or 10" Modesty Panel options.
- For conference table options, see the Preside® table tops and bases in the Tables section in the 2021 Shared Spaces Pricer. Order edge option "K".
- See pages 157-158 for modular storage components.

HOW TO SPECIFY

| | | |
|---|---|---|
| Select Model Number H 1 1 5 4 1 | Select Edge Profile See page 150 A | Select Laminate See page 150 N N |
|---|---|---|

VALIDO® Modular Returns

GSA SIN 33721



Icon Legend on page 19

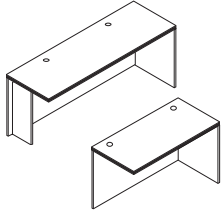

Model H115686 shown

DESCRIPTION

24" D Return Shell (with Full Modesty Panel)
 72"W x 24"D x 29½"H, (w/support; 2 grommets)
 60"W x 24"D x 29½"H, (w/support; 2 grommets)
 48"W x 24"D x 29½"H, (1 grommet)
 42"W x 24"D x 29½"H, (1 grommet)
 36"W x 24"D x 29½"H, (1 grommet)
 30"W x 24"D x 29½"H, (1 grommet)

INSIDE DIMENSIONS**MODEL****SHIP WEIGHT****CUBE****LIST PRICE**

| | | | | |
|---------------|----------------|-----|-----|--------------|
| 67"W x 22¾"D | H115686 | 161 | 5.4 | \$998 |
| 55"W x 22¾"D | H115684 | 142 | 4.9 | \$933 |
| 47"W x 22¾"D | H11561 | 97 | 3.2 | \$764 |
| 41"W x 22¾"D | H115681 | 97 | 2.5 | \$748 |
| 34⅞"W x 22¾"D | H115680 | 91 | 3.2 | \$748 |
| 28⅞"W x 22¾"D | H11568 | 78 | 2.8 | \$694 |

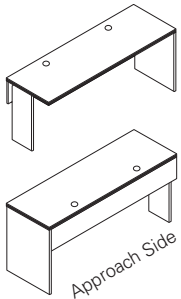
**24" D Return Shell (with 10" Modesty Panel)**

72"W x 24"D x 29½"H
 60"W x 24"D x 29½"H
 48"W x 24"D x 29½"H
 42"W x 24"D x 29½"H
 36"W x 24"D x 29½"H
 30"W x 24"D x 29½"H

| | | | | |
|---------------|-----------------|-----|-----|--------------|
| 67"W x 22¾"D | H115686X | 124 | 5.0 | \$998 |
| 55"W x 22¾"D | H115684X | 108 | 4.0 | \$933 |
| 47"W x 22¾"D | H11561X | 90 | 3.0 | \$764 |
| 41"W x 22¾"D | H115681X | 80 | 3.0 | \$748 |
| 34⅞"W x 22¾"D | H115680X | 76 | 3.0 | \$748 |
| 28⅞"W x 22¾"D | H11568X | 65 | 2.8 | \$694 |

NOTES: Shells are non-handed. No pre-drilled grommet in modesty panel (field installable grommet included). Woodgrain direction on modesty/back panel runs vertical on 30"W-60"W sizes and horizontal on 72"W unit. 36"W return shell can be used to achieve an efficient 6' x 6' footprint when connected to either a 72"W x 36"D single pedestal desk, desk shell, or peninsula, or when two are connected to a 36"W corner unit model H115811. 30"W return shell can be used to accomplish a 5' x 5' footprint when connected to a 60"W x 30"D desk shell or peninsula. See pages 166-167 for optional stack-on storage.

NOTES:

- Non-handed desk, credenza, and return shells, combined with a variety of under-the-worksurface storage solutions, maximize office layout flexibility. Shells and pedestals can be reconfigured quickly and easily when user preferences or space needs change.
- Tops are abrasion- and stain-resistant laminate over extra-thick 1½" solid core high-performance particleboard; resists warping.
- "Ribbon" edge profile; shape is on all four sides.
- Cord management grommets, for routing and hiding wires and cables, are located in the tops of desk and return shells.
- Credenza shells have a cord pass-through grommet in the top center of the modesty panel.
- The narrow design of the kneespace clearance end panel kits replace full end panels to provide added kneespace.
- Adjustable hex leveling glides allow floor-standing furniture to be easily leveled; glides have ¾" adjustable range.
- Credenza Shells available with Full or 10" Modesty Panel options.
- For conference table options, see the Preside® table tops and bases in the Tables section in the 2021 Shared Spaces Pricer. Order edge option "K".
- For work-in-process paper management tools, see page 175.
- See pages 157-158 for modular storage components.

HOW TO SPECIFY**Select Model Number**

H 1 1 5 6 8 6

Select Edge Profile

See page 150

A

Select Laminate

See page 150

N N

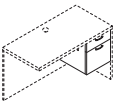
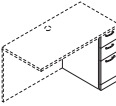
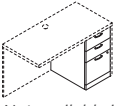
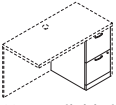

| | DESCRIPTION | MODEL | SHIP WEIGHT | CUBE | LIST PRICE |
|---|--|----------------|-------------|------|--------------|
|  <p>Not available in two-tone laminate</p> | Box/File Pedestal (with core removable lock) 15 $\frac{5}{8}$ "W x 22 $\frac{3}{4}$ "D x 17 $\frac{3}{4}$ "H NOTES: For use under 24"D, 30"D and 36"D desk, credenza and return shells. Hangrails included. Lock can be positioned on either the right or left side. Attaches to underside of worksurface top. Unfinished top and back. ! Not designed to be used freestanding. | H11501 | 57 | 5.5 | \$658 |
|  <p>Not available in two-tone laminate</p> | Narrow Box/File Pedestal — floor-standing 9 $\frac{1}{2}$ "W x 22 $\frac{3}{4}$ "D x 28"H NOTES: For use under 24"D, 30"D and 36"D modular desk, credenza and return shells. Unfinished top and back. ! Handle choices for this model are the Sweep, Crescent and Arch designs only. The linear handle (options "G" and "J") is not available on this product as the width of the component interferes with lock on the drawer face. ! Not designed to be used freestanding. | H115093 | 61 | 5.6 | \$838 |
|  <p>Not available in two-tone laminate</p> | Box/File Pedestal (with core removable lock) — floor-standing 15 $\frac{5}{8}$ "W x 22 $\frac{3}{4}$ "D x 28"H — for use under 24"D, 30"D and 36"D desk, credenza and return shells H11502 90 8.4 \$851 15 $\frac{5}{8}$ "W x 18 $\frac{3}{4}$ "D x 28"H — for use under 20"D, 24"D, 30"D and 36"D desk, credenza and return shells H115012 73 7.0 \$802 NOTES: Top box drawer does not lock. Hangrails included. Unfinished top and back. ! Not designed to be used freestanding. | | | | |
|  <p>Not available in two-tone laminate</p> | File/File Pedestal (with core removable lock) — floor-standing 15 $\frac{5}{8}$ "W x 22 $\frac{3}{4}$ "D x 28"H — for use under 24"D, 30"D and 36"D desk, credenza and return shells H11504 85 8.4 \$851 15 $\frac{5}{8}$ "W x 18 $\frac{3}{4}$ "D x 28"H — for use under 20"D, 24"D, 30"D and 36"D desk, credenza and return shells H115014 72 7.0 \$802 NOTES: Hangrails included. Unfinished top and back. ! Not designed to be used freestanding. | | | | |

NOTES:

- Pedestals can be reconfigured quickly and easily when user preferences or space needs change.
- File drawers accept hanging folders in letter or legal size.
- Narrow pedestal features a compact design that is ideal for use in U- and L-shaped layouts for smaller spaces, such as a 5' x 8' U-shaped workstation or a 5' x 5' L-shaped workstation.
- Pedestal drawers operate on full extension, ball-bearing suspensions to ensure smooth, quiet, long-lasting operation.
- Handle options shown on page 150.
- Pedestal sides are notched to enable the routing of cords and cables.
- Mobile pedestals shown on page 170, work well in a variety of configurations.
- Pedestal models ship assembled unless designated .
- Modular pedestals to be used with 24"D, 30"D and 36"D Modular Shells.
- Pedestal models not designed to be used freestanding.
- See pages 154-156 for desk, credenza and return shells.

HOW TO SPECIFY

| | | |
|---|---|---|
| Select Model Number H 1 1 5 0 1 | Select Handle Option Linear handles "G" and "J" not available on model H115093 See page 150 C | Select Laminate See page 150 N |
|---|---|---|

VALIDO® Laminate Modular Components

GSA SIN 33721



Icon Legend on page 19

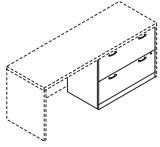

Not available in two-tone laminate

DESCRIPTION

Lateral File Pedestal (with core removable lock) — floor-standing

36"W x 20"D x 28"H — for use under 24"D, 30"D and 36"D desk, credenza and return shells

MODEL

H11503

SHIP WEIGHT

127

CUBE

15.6

LIST PRICE

\$1307

NOTES: Hangrails included. **Unfinished top and back.** Mechanical interlock inhibits extension of more than one drawer at a time.

⚠ Not designed to be used freestanding.

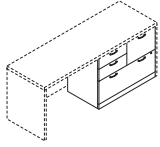

Not available in two-tone laminate

Multi File Pedestal (with core removable lock) — floor-standing

36"W x 20"D x 28"H — for use under 24"D, 30"D and 36"D desk, credenza and return shells

H11505

155

15.6

\$1549

NOTES: Versatile four drawer unit features one lateral file drawer, one vertical file drawer, and two box drawers. Box drawers do not lock. Hangrails included. **Unfinished top and back.** Mechanical interlock in lateral drawer inhibits extension of more than one drawer at a time.

⚠ Not designed to be used freestanding.

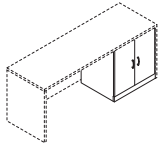

Not available in two-tone laminate

Cabinet Pedestal — floor-standing

26"W x 21¼"D x 28"H — for use under 24"D, 30"D and 36"D desk, credenza and return shells

H11508

78

12.2

\$948

NOTES: One adjustable shelf at 2½" increments. Doors are non-locking. **Unfinished top and back.**

⚠ Not designed to be used freestanding.

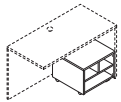

Mobile Printer/Fax Cart

20"W x 19⅞"D x 14⅞"H

H105679

52

2.9

\$415

NOTES: Holds laser printers, inkjet printers or fax machines. Ideal for limited space. Low profile cart stores conveniently and easily under desks and workstations. Interior compartment shelving is Black. Four casters. 1⅞" **thick top with flat, non-profiled edge.**

SPECIFYING EXAMPLE: H105679.NN

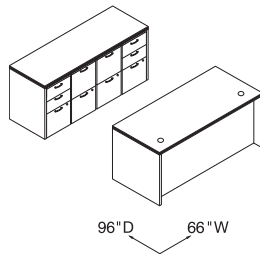

- 1 - H11579
- 1 - H11542
- 2 - H115102
- 2 - H115104

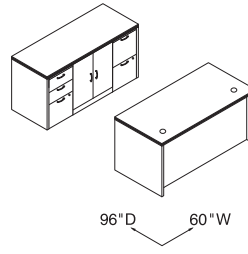

- 1 - H11578
- 1 - H11564
- 1 - H11502
- 1 - H11504
- 1 - H11508

NOTES:

- Pedestals can be reconfigured quickly and easily when user preferences or space needs change.
- See page 150 for handle design/finish options.
- File drawers accept hanging folders in letter or legal size.
- Pedestal drawers operate on full extension, ball-bearing suspensions to ensure smooth, quiet, long-lasting operation.
- Pedestal sides are notched to enable the routing of cords and cables.
- Mobile pedestals shown on page 170, work well in a variety of configurations.
- Pedestal models ship assembled unless designated ⚠.
- See pages 154-156 for desk, credenza and return shells.

HOW TO SPECIFY

| | | |
|--|---|--|
| <p>Select Model Number</p> <p>H 1 1 5 0 3</p> | <p>Select Handle Option</p> <p>See page 150 Not specified for model H105679</p> <p>C</p> | <p>Select Laminate</p> <p>See page 150</p> <p>N</p> |
|--|---|--|

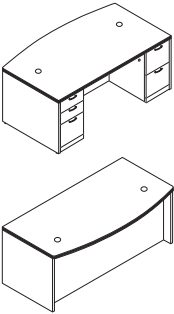
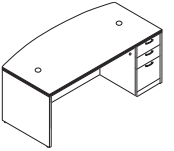
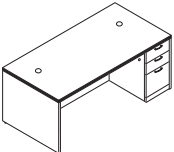

Laminate Wood Desks — Full Pedestals

| | DESCRIPTION | FULL WIDTH OVERHANG | MODEL | SHIP WEIGHT | CUBE | LIST PRICE |
|--|--|---------------------|-----------------|-------------|------|---------------|
|  | Double Pedestal Desk, 3/2 | | | | | |
| | 72"W x 36"D x 29½"H, Bow Top | 10½" | H115899 | 362 | 52.2 | \$2702 |
| | 72"W x 36"D x 29½"H, Rectangle Top | 10½" | H115890 | 370 | 52.2 | \$2570 |
| | 66"W x 30"D x 29½"H, Rectangle Top | 4½" | H115891 | 312 | 40.9 | \$2472 |
| | 60"W x 30"D x 29½"H, Rectangle Top | 4½" | H115892 | 303 | 37.3 | \$2348 |
| | NOTES: All drawers lock. Two worksurface grommets to route/hide cords. See page 174 for optional center drawers. Bow top model measures 36"D at the crest and 30" along the end panels. | | | | | |
|  | Single Pedestal Desk, Bow Top | | | | | |
| | 72"W x 36"D x 29½"H, Right | 10½" | H115893R | 308 | 52.2 | \$2370 |
| | 72"W x 36"D x 29½"H, Left | 10½" | H115894L | 308 | 52.2 | \$2370 |
| | NOTES: Box/box/file drawer configuration. Drawers lock. Two worksurface grommets to route/hide cords. See page 174 for optional center drawers. Bow top model measures 36"D at the crest and 30" along the end panels. | | | | | |
|  | Single Pedestal Desk, Rectangle Top | | | | | |
| | 72"W x 36"D x 29½"H, Right | 10½" | H115895R | 316 | 52.2 | \$2218 |
| | 66"W x 30"D x 29½"H, Right | 4½" | H115897R | 269 | 40.9 | \$2015 |
| | 72"W x 36"D x 29½"H, Left | 10½" | H115896L | 316 | 52.2 | \$2218 |
| | 66"W x 30"D x 29½"H, Left | 4½" | H115898L | 269 | 40.9 | \$2015 |
| | NOTES: Box/box/file drawer configuration. Drawers lock. Two worksurface grommets to route/hide cords. See page 174 for optional center drawers. | | | | | |

NOTES:

- Full pedestal design provides a more formal styling aesthetic and maximizes storage space.
- Drawers in pedestal extend from underside of worksurface to the floor.
- Tops are abrasion- and stain-resistant laminate over extra-thick 1½" solid core high-performance particleboard; resists warping.
- 3" round worksurface grommet can be replaced with optional Power Hub (model HGRMTAC) or Power/USB Hub (model HGRMTUSB2) to bring the ease of plug-and-play to the desktop. See page 178.
- Recessed modesty panel design facilitates conferencing. See approach side illustration at left.
- Full height modesty panels.
- Drawers operate on full extension, ball-bearing suspensions to ensure smooth, quiet, long-lasting operation.
- See page 150 for handle design/finish options.
- File drawer design includes integrated hangrails for side-to-side letter or legal filing; and front-to-back for letter filing.
- All drawers are 5-sided construction, which allows easy drawer alignment or replacement of drawer fronts.
- Desk, credenza and return models ship assembled.
- For conference table options, see the Preside® table tops and bases in the Tables section in the 2021 Shared Spaces Pricer. Order edge option "K".
- See pages 163-179 for shared components.

HOW TO SPECIFY

| | | | |
|---|---|--|---|
| Select Model Number H 1 1 5 8 9 9 | Select Edge Profile See page 150 A | Select Handle Option See page 150 C | Select Laminate See page 150 N N |
|---|---|--|---|

VALIDO®

Laminate Wood Desks — Full Pedestals

GSA SIN 33721

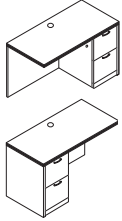

Icon Legend on page 19

**DESCRIPTION****Return, File/File**

48"W x 24"D x 29½"H, Right
 42"W x 24"D x 29½"H, Right
 48"W x 24"D x 29½"H, Left
 42"W x 24"D x 29½"H, Left

NOTES: Return is for use with single pedestal desks, desk shells, peninsulas or corner units. Drawers lock. One worksurface grommet and one cord pass-through grommet in top center of modesty panel to reach wall electrical outlets. See pages 166-167 for optional stack-on storage.

FULL WIDTH OVERHANG**MODEL****SHIP WEIGHT****CUBE****LIST PRICE**

| | | | | |
|--|-----------------|-----|------|---------------|
| | H115905R | 168 | 24.9 | \$1472 |
| | H115907R | 159 | 20.5 | \$1457 |
| | H115906L | 168 | 24.9 | \$1472 |
| | H115908L | 159 | 20.5 | \$1457 |

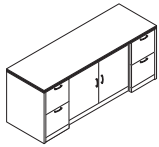
**Credenza with Doors**

72"W x 24"D x 29½"H

3½"

H115909

340

36.0

\$2690

NOTES: All drawers lock. Doors are non-locking. One cord pass-through grommet in top center of modesty panel. Includes a fixed shelf located at the bottom of the center storage area. No intermittent shelf. See pages 166-167 for optional stack-on storage.

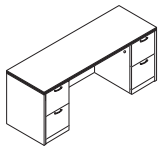
**Credenza with Kneespace — 2/0/2**

72"W x 24"D x 29½"H

3½"

H115900

296

36.0

\$2291

66"W x 24"D x 29½"H

3½"

H115901

286

31.6

\$2180

60"W x 24"D x 29½"H

3½"

H115902

257

28.8

\$2110

NOTES: All drawers lock. One cord pass-through grommet in top center of modesty panel. See pages 166-167 for optional stack-on storage.

ⓘ Not designed to be used with Valido/11500 Series 22¾"D modular or mobile pedestals. Modesty/back panel is inset 3½".

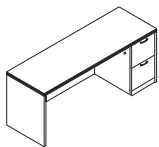
**Single Pedestal Credenza, File/File**

72"W x 24"D x 29½"H, Right (shown)

3½"

H115903R

251

36.0

\$1885

72"W x 24"D x 29½"H, Left

3½"

H115904L

251

36.0

\$1885

NOTES: Drawers lock. One cord pass-through grommet in top center of modesty panel. See pages 166-167 for optional stack-on storage.

ⓘ Not designed to be used with Valido/11500 Series 22¾"D modular or mobile pedestals. Modesty/back panel is inset 3½".

NOTES:

- Full pedestal design provides a more formal styling aesthetic and maximizes storage space.
- Drawers in pedestal extend from underside of worksurface to the floor.
- Tops are abrasion- and stain-resistant laminate over extra-thick 1½" solid core high-performance particleboard; resists warping.
- Recessed modesty panel design facilitates conferencing. See approach side illustration at left.
- Full height modesty panels.
- Drawers operate on full extension, ball-bearing suspensions to ensure smooth, quiet, long-lasting operation.
- See page 150 for handle design/finish options.
- File drawer design includes integrated hangrails for side-to-side letter or legal filing; and front-to-back for letter filing.
- All drawers are 5-sided construction, which allows easy drawer alignment or replacement of drawer fronts.
- Valido® 18¾"D modular and mobile pedestals can be positioned under credenza with kneespace and single pedestal credenza models.
- Desk, credenza and return models ship assembled.
- For conference table options, see the Preside® table tops and bases in the Tables section in the 2021 Shared Spaces Pricer. Order edge option "K".
- See pages 163-179 for shared components.

HOW TO SPECIFY**Select Model Number**

H 1 1 5 9 0 5 R .

Select Edge Profile

See page 150

A .

Select Handle Option

See page 150

C .

Select Laminate

See page 150

N N



| | DESCRIPTION | FULL WIDTH OVERHANG | MODEL | SHIP WEIGHT | CUBE | LIST PRICE |
|---|--|---------------------|-----------------|-------------|---------|---------------|
| | Double Pedestal Desk, 2-2 | | | | | |
| | 72"W x 36"D x 29½"H, Bow Top | 10½" | H11595 | 356 | 52.2 | \$2172 |
| | 72"W x 36"D x 29½"H, Rectangle Top | 10½" | H11593 | 364 | 52.2 | \$1989 |
| | 66"W x 30"D x 29½"H, Rectangle Top | 4½" | H11571 | 304 | 40.9 | \$1897 |
| | 60"W x 30"D x 29½"H, Rectangle Top | 4½" | H11573 | 288 | 37.3 | \$1790 |
| | NOTES: All drawers lock. Two worksurface grommets to route/hide cords. See page 174 for optional center drawers. | | | | | |
| | Single Pedestal Desk, Bow Top | | | | | |
| | 72"W x 36"D x 29½"H, Right | 10½" | H11587R | 264 | 52.9 | \$1914 |
| | 72"W x 36"D x 29½"H, Left | 10½" | H11588L | 264 | 52.9 | \$1914 |
| | NOTES: Drawers lock. Two worksurface grommets to route/hide cords. See page 174 for optional center drawers. Bow top models measure 36"D at the crest and 30"D along the end panels. | | | | | |
| | Single Pedestal Desk, Rectangle Top | | | | | |
| | 72"W x 36"D x 29½"H, Right | 10½" | H11585R | 303 | 52.2 | \$1691 |
| | 66"W x 30"D x 29½"H, Right | 4½" | H11583R | 247 | 40.9 | \$1580 |
| | 72"W x 36"D x 29½"H, Left | 10½" | H11586L | 303 | 52.2 | \$1691 |
| | 66"W x 30"D x 29½"H, Left | 4½" | H11584L | 247 | 40.9 | \$1580 |
| | NOTES: Drawers lock. Two worksurface grommets to route/hide cords. See page 174 for optional center drawers. | | | | | |
| | Small Office Desk | | | | | |
| | 48"W x 30"D x 29½"H | 4½" | H115885R | 183 | 30.0 | \$1275 |
| | NOTES: Small footprint makes this desk ideal for limited space. Drawers lock. One cord grommet in top for routing and hiding wires and cables. 3/4 length modesty panel facilitates reaching wall electrical outlets. Optional stack-on storage model H115323 maximizes storage space; see pages 166-167 for additional stack-on storage models. | | | | | |
| | Return, Box/File | | | | | |
| | 48"W x 24"D x 29½"H, Right | | H11515R | 158 | 24.9 | \$1231 |
| | 42"W x 24"D x 29½"H, Right | | H11511R | 146 | 20.5 | \$1217 |
| | 48"W x 24"D x 29½"H, Left | | H11516L | 158 | 24.9 | \$1231 |
| | 42"W x 24"D x 29½"H, Left | | H11512L | 146 | 20.5 | \$1217 |
| | NOTES: Return is for use with single pedestal desks, desk shells, peninsulas or corner units. Drawers lock. One worksurface grommet and one cord pass-through grommet in top center of modesty panel to reach wall electrical outlets. See pages 166-167 for optional stack-on storage. | | | | | |
| ⓘ Not designed to be used freestanding. | | | | | | |
| | | H11584L | | | | |
| | | H11515R | | | | |
| | | H115327 | | | | |
| | | H115520 | | | | |
| | | H115523 | | | | |
| | | HLVPM1 | | | | |
| | | | H11587R | | | |
| | | | H115598 | | | |
| | | | H115811 | | H115524 | |
| | | | H11516L | | H115327 | |
| | | | H115301 | | HLVPM1 | |

NOTES:

- For components that can be shared with Valido/11500 Series, see pages 163-179.
- Tops are abrasion- and stain-resistant laminate over extra-thick 1½" solid core high-performance particleboard; resists warping.
- 3/4 pedestal design increases budget flexibility.
- Formal, full height modesty panels.
- 3" round worksurface grommet can be replaced with optional Power Hub (model HGRMTAC) or Power/USB Hub (model HGRMTUSB2) to bring the ease of plug-and-play to the desktop. See page 178.
- All drawers are 5-sided construction, which allows easy drawer alignment or replacement of drawer fronts.
- The small footprint of the Small Office Desk is ideal for limited space.
- Drawers operate on full extension, ball-bearing suspensions to ensure smooth, quiet, long-lasting operation.
- See page 150 for handle design/finish options.
- Center drawers conveniently store writing instruments, paper and other miscellaneous items. Includes pencil tray. See page 174.
- File drawer design includes integrated hangrails for side-to-side letter or legal filing; and front-to-back for letter filing.
- Desk, credenza and return models ship assembled.
- See pages 166-167 for optional stack-on storage.
- For conference table options, see the Preside® table tops and bases in the Tables section in the 2021 Shared Spaces Pricer. Order edge option "K".

HOW TO SPECIFY

| | | | |
|----------------------------|----------------------------|-----------------------------|------------------------|
| Select Model Number | Select Edge Profile | Select Handle Option | Select Laminate |
| See page 150 | See page 150 | See page 150 | See page 150 |
| H 1 1 5 9 5 . | A . | C . | N N |

VALIDO® Laminate Wood Desks — 3/4 Pedestals

GSA SIN 33721



Icon Legend on page 19

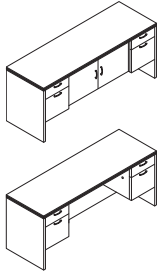

| DESCRIPTION | FULL WIDTH OVERHANG | MODEL | SHIP WEIGHT | CUBE | LIST PRICE |
|---|---------------------|---------------|-------------|------|---------------|
| Credenza with Doors 72"W x 24"D x 29½"H | 3½" | H11544 | 294 | 36.0 | \$2189 |
| Credenza with Kneespace 72"W x 24"D x 29½"H | 3½" | H11543 | 259 | 36.0 | \$1843 |
| 66"W x 24"D x 29½"H | 3½" | H11566 | 249 | 31.6 | \$1790 |
| 60"W x 24"D x 29½"H | 3½" | H11565 | 239 | 28.8 | \$1725 |

NOTES: Includes one fixed shelf at the bottom of the center storage area. All drawers lock. Doors are non-locking.

NOTES: One cord pass-through grommet in top center of modesty panel to reach wall electrical outlets. All drawers lock. See pages 166-167 for optional stack-on storage.

⚠ Not designed to be used with Valido/11500 Series 22¾"D modular or mobile pedestals. Modesty/back panel is inset 3½".

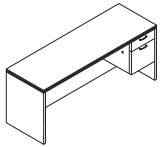

| | | | | | |
|--|-----|----------------|-----|------|---------------|
| Credenza, Single Pedestal, Box/File 72"W x 24"D x 29½"H, Right (shown) | 3½" | H11545R | 228 | 36.0 | \$1546 |
| 72"W x 24"D x 29½"H, Left | 3½" | H11546L | 228 | 36.0 | \$1546 |

NOTES: One cord pass-through grommet in top center of modesty panel to reach wall electrical outlets. Drawers lock. See pages 166-167 for optional stack-on storage.

⚠ Not designed to be used with Valido/11500 Series 22¾"D modular or mobile pedestals. Modesty/back panel is inset 3½".

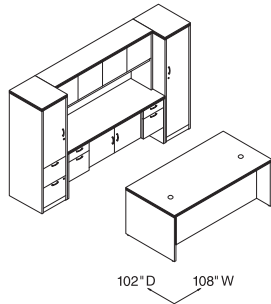

H11593
H11544
H115295R
H115298L
H11534

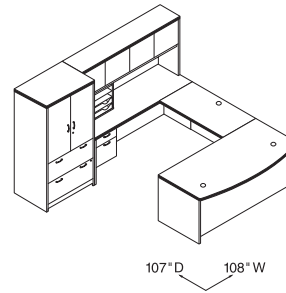

H11587R
H11570
H11546L
H11534
H115293
HLVPM1

NOTES:

- For components that can be shared with Valido/11500 Series, see pages 163-179.
- Tops are abrasion- and stain-resistant laminate over extra-thick 1½" solid core high-performance particleboard; resists warping.
- Formal, full height modesty panels.
- Cord management grommets, for routing and hiding wires and cables, are located in the tops of desks, returns, bridges and corner units.
- All drawers are 5-sided construction, which allows easy drawer alignment or replacement of drawer fronts.
- Drawers operate on full extension, ball-bearing suspensions to ensure smooth, quiet, long-lasting operation.
- See page 150 for handle design/finish options.
- File drawer design includes integrated hangrails for side-to-side letter or legal filing; and front-to-back for letter filing.
- For conference table options, see the Preside® table tops and bases in the Tables section in the 2021 Shared Spaces Pricer. Order edge option "K".

HOW TO SPECIFY

| | | | |
|---|---|--|--|
| <p>Select Model Number</p> <p>H 1 1 5 4 4</p> | <p>Select Edge Profile</p> <p>See page 150</p> <p>A</p> | <p>Select Handle Option</p> <p>See page 150</p> <p>C</p> | <p>Select Laminate</p> <p>See page 150</p> <p>NN</p> |
|---|---|--|--|

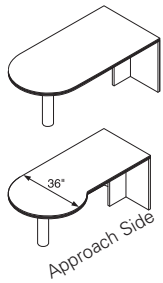
**DESCRIPTION****Peninsula w/End Panel**

72"W x 36"D x 29½"H
66"W x 30"D x 29½"H
60"W x 30"D x 29½"H

MODEL

H11521E
H11522E
H11523E

SHIP WEIGHT

167
138
115

CUBE

8.1
6.6
6.6

LIST PRICE

\$1196
\$1091
\$1014

P-shaped Peninsula w/End Panel

72"W x 30/36"D x 29½"H, Right
72"W x 36/30"D x 29½"H, Left

H11525RE
H11526LE

159
159

8.1
8.1

\$1330
\$1330

NOTES: Use for "U" or "L" configuration. 60"W ideal for smaller spaces. Cord routing notch in brace panel. Accept field installable modesty panel model H10528 (see page 164). See page 174 for optional center drawers. Peninsulas ship complete with end panel and support column. Support column is black.

❗ Not designed to be used freestanding.

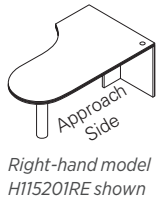

Right-hand model
H115201RE shown

Jetty Peninsula w/End Panel

72"W x 30/42"D x 29½"H, Right
72"W x 42/30"D x 29½"H, Left

H115201RE
H115202LE

175
175

9.4
9.4

\$1542
\$1542

NOTES: For use in "U" or "L" configuration. Designed and sized to efficiently serve as both a computing and conferencing space. One cord management grommet in the top; cord routing notch in brace panel. Jetty units manufactured on or after 10/24/2005 accept field installable modesty panel H10528 (see page 164). Peninsulas ship complete with end panel and support column. Support column is black.

❗ Not designed to be used freestanding.

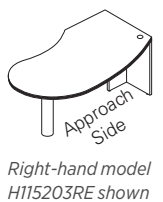
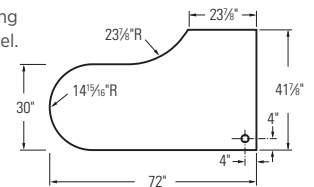

Right-hand model
H115203RE shown

Boomerang Peninsula w/End Panel

72"W x 30/42"D x 29½"H, Right
72"W x 42/30"D x 29½"H, Left

H115203RE
H115204LE

175
175

9.4
9.4

\$1542
\$1542

NOTES: For use in "U" or "L" configuration. Designed and sized to efficiently serve as both a computing and conferencing space. One cord management grommet in the top; cord routing notch in brace panel. Accepts field installable modesty panel H10528 (see page 164). Peninsulas ship complete with end panel and support column. Support column is black.

❗ Not designed to be used freestanding.

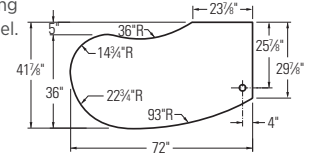
**NOTES:**

- Shared components shown on this page can be used with modular components shown on pages 154-158, full pedestal models shown on pages 159-160, and 3/4 pedestal models shown on pages 161-162.
- Mobile pedestals shown on page 170 work well in a variety of configurations.
- Peninsulas ship complete with end panel and black 3" diameter support column. For a silver support column option, please see model HPC191X on page 281 (ordered separately).
- Jetty, Boomerang, and Rudder peninsulas are designed and sized to efficiently serve as both a computing and conferencing space.
- Adjustable hex leveling glides allow floor-standing furniture to be easily leveled; glides have ¾" adjustable range.
- For conference table options, see the Preside® table tops and bases in the Tables section in the 2021 Shared Spaces Pricer. Order edge option "K".
- See pages 163-179 for shared components.

HOW TO SPECIFY

| Select Model Number | Select Edge Profile | Select Laminate | Select Paint Color |
|---------------------|---------------------|-----------------|---------------------------------------|
| See page 150 | See page 150 | See page 150 | Specify for new peninsula models only |
| P | A | NN | P Black |

VALIDO® Shared Components & Accessories

GSA SIN 33721



Icon Legend on page 19

**DESCRIPTION****MODEL****SHIP WEIGHT****CUBE****LIST PRICE****Field Installable Modesty Panel for Peninsulas**

50¼"W x ¾"Thick x 18"H

H10528

25

1.3

\$203

NOTES: Center drawer model H1522 can be used in conjunction with modesty panel. Laminate Modesty Panel has a cord pass-through notch in top corner.

⚠ Not designed to be used on jetty peninsulas manufactured prior to 10/24/2005.

SPECIFYING EXAMPLE: H10528.N

**Field Installable Modesty Panel for Bullet, Jetty and Boomerang Peninsulas, Frosted with Silver Frame**

50¼"W x ¾"Thick x 18"H

HPC180G

33 Ⓢ

1.5

\$745

NOTES: For use on 72"W peninsulas. Frosted/silver modesty panel HPC180G can be used with Valido, 10700, 10600 and 10500 Series™ peninsula models. Cord pass-through notch is not available on the Frosted/Silver model HPC180G. Notch is on laminate model H10528 only.

⚠ Center drawers not designed to be used with the frosted/silver modesty panel model HPC180G.

NOTES:

- Shared components shown on this page can be used with modular components shown on pages 154-158, full pedestal models shown on pages 159-160, and 3/4 pedestal models shown on pages 161-162.
- Mobile pedestals shown on page 170 work well in a variety of configurations.
- Peninsulas ship complete with end panel and black 3" diameter support column. For a silver support column option, please see model HPC191X on page 281 (ordered separately).
- Jetty, Boomerang and Rudder peninsulas are designed and sized to efficiently serve as both a computing and conferencing space.
- Adjustable hex leveling glides allow floor-standing furniture to be easily leveled; glides have ¾" adjustable range.
- For conference table options, see the Preside® table tops and bases in the Tables section in the 2021 Shared Spaces Pricer. Order edge option "K".
- See pages 163-179 for shared components.

HOW TO SPECIFY**Select Model Number**

H 1 0 5 2 8 .

Select Laminate

See page 150

N N

**DESCRIPTION****MODEL****SHIP WEIGHT****CUBE****LIST PRICE****Bridge (Single Ped. Desk, Desk Shell or Peninsula, to Corner Unit, Single Ped. Credenza or Credenza Shell)**

47"W x 24"D x 29½"H, (Clear inside depth = 21⅞"D)

H11570

86

3.2

\$560

42"W x 24"D x 29½"H, (Clear inside depth = 21⅞"D)

H11560

81

2.9

\$536

36"W x 24"D x 29½"H, (Clear inside depth = 21⅞"D) (see notes below)

H115599

69

2.9

\$536

30"W x 24"D x 29½"H, (Clear inside depth = 21⅞"D) (see notes below)

H115598

57

2.2

\$536

47"W x 20"D x 29½"H, (Clear inside depth = 17⅞"D) (see notes below)

H115699

70

3.2

\$536

42"W x 20"D x 29½"H, (Clear inside depth = 17⅞"D) (see notes below)

H115698

62

2.9

\$513

NOTES: One worksurface grommet and one grommet in top and in top center of modesty panel. Grommet can be replaced with optional Power Hub or Power/USB Hub for easy plug-and-play (see page 178). Kneespace of desk limited to 24¾"W if bridge is used with 66"W single pedestal desk. H115599 is for use with corner or extended corner units or jetty or boomerang peninsulas. H115598 is for use with corner or extended corner units. H115699 and H115698 are for use with single pedestal desks, desk shells or peninsulas (excluding jetty and boomerang).

Specify: Model.Edge.Laminate

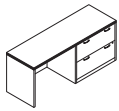
SPECIFYING EXAMPLE: H11570.A.NN**Credenza with 36" Lateral (with core removable locks)**

72"W x 24"D x 29½"H, Right (shown)

H11547R

264

36.0

\$1977

72"W x 24"D x 29½"H, Left

H11548L

264

36.0

\$1977

NOTES: Includes hangrails. Mechanical interlock inhibits the extension of more than one drawer at a time. See pages 166-167 for optional stack-on storage.

⚠ Not designed to be used with Valido/11500 Series 22¾"D modular or mobile pedestals. Modesty/back panel is inset 3½".

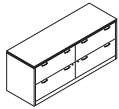
**Credenza with two Lateral Files (with core removable locks)**

72"W x 24"D x 29½"H

H115491

330

36.0

\$2771

NOTES: 4 locking drawers. Each lock secures 2 drawers. Includes hangrails; mechanical interlock inhibits the extension of more than one drawer at a time. If side-by-side drawers are opened or closed simultaneously, one drawer may interfere with the other. See pages 166-167 for optional stack-on storage.

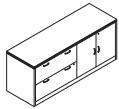
**Credenza with Lateral File, left and Storage Cabinet, right (with core removable locks)**

72"W x 24"D x 29½"H

H115492

323

36.0

\$2513

NOTES: Includes hangrails; mechanical interlock inhibits the extension of more than one drawer at a time. Storage cabinet locks and includes one adjustable interior shelf. Shelf adjusts in 1¼" increments with a total range of 5"H. See pages 166-167 for optional stack-on storage.

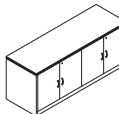
**Credenza w/Two Storage Cabinets**

72"W x 24"D x 29½"H

H115493

320

35.6

\$2231

NOTES: Each storage cabinet has one interior shelf which adjusts in 1¼" increments over a total range of 5". Each cabinet locks independently. Locks are keyed alike. For optional stack-on storage, see pages 166-167 for additional stack-on storage models.

NOTES:

- Shared components shown on this page can be used with modular components shown on pages 154-158, full pedestal models shown on pages 159-160, and 3/4 pedestal models shown on pages 161-162.
- Mobile pedestals shown on page 170 work well in a variety of configurations.
- Locking units equipped with interchangeable core removable locks.
- File drawers accept hanging folders in letter or legal size.
- See page 150 for handle design/finish options.
- Adjustable hex leveling glides allow floor-standing furniture to be easily leveled; glides have ¾" adjustable range.
- See pages 163-179 for shared components.

⚠ Keyed alike cores must be ordered separately — see page 773.

HOW TO SPECIFYSelect
Model Number

H 1 1 5 4 7 R .

Select
Edge Profile

See page 150

A .

Select
Handle Option

See page 150

Not specified on Bridge models

C .

Select
Laminate

See page 150

N N

VALIDO® Shared Components & Accessories

GSA SIN 33721

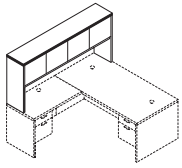

Icon Legend on page 19

**DESCRIPTION****Stack-on Storage for an "L" Workstation**78"W x 14⁵/₈"D x 37¹/₂"H**MODEL SHIP WEIGHT CUBE LIST PRICE****H115327 209 17.6 \$1593****Stack-on Storage for an "L" Workstation, Locking**78"W x 14⁵/₈"D x 37¹/₂"H**H115327K 209 17.6 \$1682**

NOTES: Spans the total depth dimension of configurations comprised of: 48"W return or return shell attached to a 30"D single pedestal desk, desk shell or peninsula (78"D); 42"W return or return shell attached to a 36"D single pedestal desk, desk shell or peninsula (78"D). 42"W return or return shell attached to a 36" corner unit (78"D); or 42"W curved return attached to 36" curved corner unit (78"D). Use back enclosure model H105857 and tackboard model H90057 (see page 168). Use task light models HH870960, or HH870960CH (see page 595). For vertical paper manager model HLVPM1, see page 175.

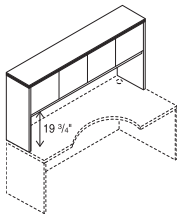
**Stack-on Storage (See page 168 for Back Enclosures and Fabric Tackboards)**72"W x 14⁵/₈"D x 37¹/₂"H, 4 doors (Use Task Light model HH870960, see page 177)**H11534 195 16.9 \$1432**66"W x 14⁵/₈"D x 37¹/₂"H, 4 doors (Use Task Light model HH870960, see page 177)**H11533 184 15.3 \$1398**60"W x 14⁵/₈"D x 37¹/₂"H, 4 doors (Use Task Light model HH870960, see page 177)**H115324 172 14.0 \$1338**48"W x 14⁵/₈"D x 37¹/₂"H, 3 doors (Use Task Light model HH870942, see page 177)**H115323 148 11.3 \$1164**42"W x 14⁵/₈"D x 37¹/₂"H, 2 doors (Use Task Light model HH870942, see page 177)**H115322 141 4.0 \$1001**36"W x 14⁵/₈"D x 37¹/₂"H, 2 doors (Use Task Light model HH870930, see page 177)**H115321 107 3.5 \$960****Stack-on Storage, Locking (See page 168 for Back Enclosures and Fabric Tackboards)**72"W x 14⁵/₈"D x 37¹/₂"H, 4 doors (Use Task Light model HH870960, see page 177)**H11534K 195 16.9 \$1523**66"W x 14⁵/₈"D x 37¹/₂"H, 4 doors (Use Task Light model HH870960, see page 177)**H11533K 184 15.3 \$1489**60"W x 14⁵/₈"D x 37¹/₂"H, 4 doors (Use Task Light model HH870960, see page 177)**H115324K 172 14.0 \$1429**48"W x 14⁵/₈"D x 37¹/₂"H, 3 doors (Use Task Light model HH870942, see page 177)**H115323K 148 11.3 \$1232**42"W x 14⁵/₈"D x 37¹/₂"H, 2 doors (Use Task Light model HH870942, see page 177)**H115322K 141 4.0 \$1046**36"W x 14⁵/₈"D x 37¹/₂"H, 2 doors (Use Task Light model HH870930, see page 177)**H115321K 107 3.5 \$1005**

NOTES: Models H11534 and H11534K can be used for "L" configuration comprised of 30"D desk, desk shell or peninsula and 42"W return or return shell. Model H115323K has one lock which secures two of the three doors. For vertical paper manager, see page 175.

NOTES:

- Shared components shown on this page can be used with modular components shown on pages 154-158, full pedestal models shown on pages 159-160, and 3/4 pedestal models shown on pages 161-162.
- Stack-on storage models are equipped with self-closing, adjustable hinged doors and valance to hide task light.
- For work-in-process paper management tools, see page 175.
- See pages 163-179 for shared components.

❗ Removable lock core kit for stack-on and wall mount storage is model HF27B, see page 773.

❗ The HON Company is not responsible for any liabilities resulting from wall mounted storage cabinets that are not properly installed.

HOW TO SPECIFY

Select
Model Number

H 1 1 5 3 4

Select
Edge Profile

See page 150

A

Select
Laminate

See page 150

N N

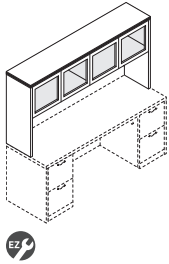

DESCRIPTION

MODEL SHIP WEIGHT CUBE LIST PRICE

Stack-on Storage for an "L" Workstation, Frosted Doors with Silver Frame

78"W x 14 5/8"D x 37 1/2"H, 4 doors (Use Task Light model HH870960, see page 177)

H115327G 210 18.4 **\$2355**

NOTES: Spans the total depth dimension of configurations comprised of: 48"W return or return shell attached to a 30"D single pedestal desk, desk shell or peninsula (78"D); 42"W return or return shell attached to a 36"D single pedestal desk or desk shell with a rectangle top, or to a peninsula (78"D). 42"W return or return shell attached to a 36" corner unit (78"D); 42"W curved return attached to 36" curved corner unit (78"D); or 36"W return shell attached to a jetty peninsula (78"D). Use back enclosure model H105857 and tackboard model H90057. Use task light models HH870960 or HH870960CH. For vertical paper manager model HLVPM1, see page 175.

Stack-on Storage, w/Frosted Doors with Silver Frame

72"W x 14 5/8"D x 37 1/2"H, 4 doors (Use Task Light model HH870960, see page 177)

H11534G 196 17.0 **\$2189**

66"W x 14 5/8"D x 37 1/2"H, 4 doors (Use Task Light model HH870960, see page 177)

H11533G 185 15.6 **\$2154**

60"W x 14 5/8"D x 37 1/2"H, 4 doors (Use Task Light model HH870960, see page 177)

H115324G 173 14.2 **\$2091**

48"W x 14 5/8"D x 37 1/2"H, 3 doors (Use Task Light model HH870942, see page 177)

H115323G 148 11.5 **\$1733**

42"W x 14 5/8"D x 37 1/2"H, 2 doors (Use Task Light model HH870942, see page 177)

H115322G 141 4.1 **\$1389**

36"W x 14 5/8"D x 37 1/2"H, 2 doors (Use Task Light model HH870930, see page 177)

H115321G 107 4.1 **\$1345**

NOTES: For respective desk, credenza or return widths. Model 11534 can be used for "L" configuration comprised of a 42"W return or return shell attached to a 30"D single pedestal desk, desk shell or peninsula (72"); 36"W return shell attached to a 36"D single pedestal desk, desk shell or peninsula (72"); or 30"W return shell attached to a jetty peninsula (72"). Back enclosures, tackboards for use with back enclosures and task lights are available as options. See vertical paper manager model HLVPM1 on page 175.

Stack-on Storage models H115327G, H11534G, H11533G and H115324G use task light model HH870960. Models H115323G and H115322G use task light model HH870942 and model H115321G uses task light model HH870930. All task lights can be found on page 177.

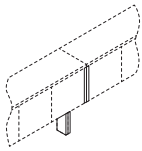

Stack-on Storage Clearance End Panel Kit

1 1/8"W x 4 5/8"-14 5/8"D x 36"H

H105349 29 3.4 **\$382**

Two field installable end panels (1-right; 1-left) for use in ganging two 10500 or Valido® Series stack-on storage units. See page 302.

NOTES: Can be used to connect up to two stack-on storage units in a line (requires 1 kit). Not available in two-tone laminate.

SPECIFYING EXAMPLE: H105349.N

NOTES:

- Shared components shown on this page can be used with modular components shown on pages 154-158, full pedestal models shown on pages 159-160, and 3/4 pedestal models shown on pages 161-162.
- Stack-on storage models are equipped with self-closing, adjustable hinged doors and valance to hide task light.
- For work-in-process paper management tools, see page 175.
- See pages 163-179 for shared components.

! Removable lock core kit for stack-on and wall mount storage is model HF27B, see page 773.

! The HON Company is not responsible for any liabilities resulting from wall mounted storage cabinets that are not properly installed.

HOW TO SPECIFY

| | | |
|---|---|--|
| <p>Select Model Number</p> <p>H 1 1 5 3 2 7 G .</p> | <p>Select Edge Profile</p> <p>See page 150</p> <p>A .</p> | <p>Select Laminate</p> <p>See page 150</p> <p>NN</p> |
|---|---|--|

VALIDO® Shared Components & Accessories

GSA SIN 33721

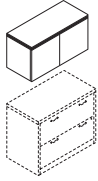

Icon Legend on page 19

**DESCRIPTION****Wall Mounted Storage Cabinet**

30"W x 14⁵/₈"D x 17⁷/₈"H, 2 doors
(Use Task Light model HH870930, see page 177)
36"W x 14⁵/₈"D x 17⁷/₈"H, 2 doors
(Use Task Light model HH870930, see page 177)
42"W x 14⁵/₈"D x 17⁷/₈"H, 2 doors
(Use Task Light model HH870942, see page 177)
48"W x 14⁵/₈"D x 17⁷/₈"H, 3 doors
(Use Task Light model HH870942, see page 177)

MODEL**COM****SHIP WEIGHT****CUBE****LIST PRICE**

| | | | | |
|----------------|--|-----|------|---------------|
| H115380 | | 77 | 8.7 | \$967 |
| H115381 | | 92 | 10.2 | \$1018 |
| H115382 | | 103 | 11.7 | \$1095 |
| H115383 | | 121 | 14.0 | \$1183 |

Wall Mounted Storage Cabinet, Locking

30"W x 14⁵/₈"D x 17⁷/₈"H, 2 doors
(Use Task Light model HH870930, see page 177)
36"W x 14⁵/₈"D x 17⁷/₈"H, 2 doors
(Use Task Light Model HH870930, see page 177)
42"W x 14⁵/₈"D x 17⁷/₈"H, 2 doors
(Use Task Light Model HH870942, see page 177)
48"W x 14⁵/₈"D x 17⁷/₈"H, 3 doors
(Use Task Light Model HH870942, see page 177)

| | | | | |
|-----------------|--|-----|------|---------------|
| H115380K | | 77 | 8.7 | \$1013 |
| H115381K | | 92 | 10.2 | \$1064 |
| H115382K | | 103 | 11.7 | \$1141 |
| H115383K | | 121 | 14.0 | \$1252 |

NOTES: Horizontal interlocking rails are included; due to varying types of walls, installers are responsible for selecting and supplying the appropriate fasteners. Tackboard widths differ slightly from wall mounted storage cabinet widths. For applications where multiple wall mounted storage cabinets are placed side-by-side, the preferred tackboard solution may be to utilize a larger tackboard size. For example, H90057 = 75"W; H90056 = 68³/₄"W; H90055 = 62³/₄"W; H90054 = 56³/₄"W. For paper organizer tools, see page 175.

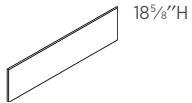
18⁵/₈"H

Not available in two-tone laminate

Back Enclosure for Stack-on Storage

75³/₄"W - for 78"W model #H115327
69³/₄"W - for 72"W model #H11534
63³/₄"W - for 66"W model #H11533
57³/₄"W - for 60"W model #H115324
45³/₄"W - for 48"W model #H115323
39³/₄"W - for 42"W model #H115322
33³/₄"W - for 36"W model #H115321

| | | | | |
|----------------|--|----|-----|--------------|
| H105857 | | 39 | 1.4 | \$275 |
| H105856 | | 33 | 1.3 | \$252 |
| H105855 | | 31 | 1.3 | \$235 |
| H105854 | | 29 | 1.3 | \$224 |
| H105853 | | 23 | 0.9 | \$224 |
| H105852 | | 21 | 0.9 | \$214 |
| H105851 | | 18 | 0.9 | \$202 |

NOTES: Non-tackable. Specify laminate.

SPECIFYING EXAMPLE: H105857.N

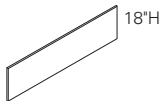

18"H

Tackboards for use with Stack-on Back Enclosures

75"W - for 78"W model #H115327 Hutch with #H105857 Enclosure
68³/₄"W - for 72"W model #H11534 Hutch with #H105856 Enclosure
62³/₄"W - for 66"W model #H11533 Hutch with #H105855 Enclosure
56³/₄"W - for 60"W model #H115324 Hutch with #H105854 Enclosure
44³/₄"W - for 48"W model #H115323 Hutch with #H105853 Enclosure
39"W - for 42"W model #H115322 Hutch with #H105852 Enclosure
33"W - for 36"W model #H115321 Hutch with #H105851 Enclosure

| | | | | |
|---------------|-----|----|-----|--------------|
| H90057 | 3.0 | 13 | 3.2 | \$337 |
| H90056 | 2.0 | 12 | 2.7 | \$320 |
| H90055 | 2.0 | 11 | 2.5 | \$304 |
| H90054 | 2.0 | 10 | 2.2 | \$268 |
| H90053 | 2.0 | 8 | 1.8 | \$257 |
| H90052 | 2.0 | 7 | 1.6 | \$237 |
| H90051 | 1.0 | 6 | 1.4 | \$208 |

NOTES: Specify fabric, see pages 25-26. Upcharges may apply to premium fabric grades.

❗ Disperse (DISP) fabric not available on sizes wider than 60". Analog (ANLG) and Exchange (EXG) not available on sizes wider than 72".

❗ Back Enclosures must be ordered separately.

SPECIFYING EXAMPLE: H90057.APN15

NOTES:

- Shared components shown on this page can be used with modular components shown on pages 154-158, full pedestal models shown on pages 159-160, and 3/4 pedestal models shown on pages 161-162.
- Back enclosure features full-width 1¹/₈" slot at the bottom to facilitate routing cords and reaching wall electrical outlets.
- Tackboard is sized ³/₄" narrower than stack-on storage back enclosure, allowing ³/₈" on each side to route task light cord.
- Wall mounted storage cabinet attachment requires individual cabinets be secured by a minimum of two wall mounting locations/studs.
- Wall mounted storage cabinets are designed for interior and perimeter walls that are constructed with wood or metal studs.
- Wall attachment methodology: horizontally mounted, interlocking brackets.
- Wall mounted storage cabinet door design overlaps end panels so that when multiple units are placed side-by-side they appear as one continuous unit.
- See pages 163-179 for shared components.

❗ Removable lock core kit for stack-on and wall mount storage is model HF27B, see page 773.

❗ The HON Company is not responsible for any liabilities resulting from wall mounted storage cabinets that are not properly installed.

HOW TO SPECIFY

Select
Model Number

H 1 1 5 3 8 0 .

Select
Edge Profile

See page 150

A .

Select
Laminate

See page 150

N N

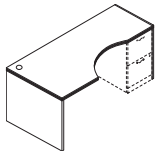

Right-hand model
H115815R shown

DESCRIPTION

Extended Corner Unit

24"W x 36"D x 72"W x 24"D x 29½"H, Right (shown)
24"D x 72"W x 36"D x 24"W x 29½"H, Left

MODEL SHIP WEIGHT CUBE LIST PRICE

| | | | |
|-----------------|-----|-----|---------------|
| H115815R | 203 | 7.0 | \$1450 |
| H115816L | 203 | 7.0 | \$1450 |

NOTES: Can be used freestanding. One grommet in top and in modesty panel. Accept Valido/11500 Series modular or mobile pedestals. See pages 166-167 for optional stack-on storage.

ⓘ Designed to be used with returns or bridges.

SPECIFYING EXAMPLE: H115815R.A.NN

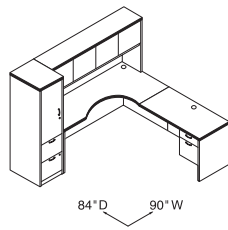
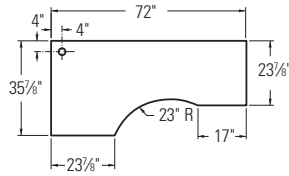

H115298L
H115816L
H11534
H11515R

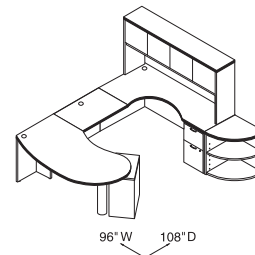

H115103
H115204L
H115598
H115815R
H115104
H11534
H115520

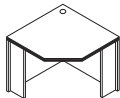

Corner Unit

24" x 36" x 36" x 24" x 29½"H

| | | | |
|----------------|-----|-----|---------------|
| H115811 | 141 | 3.1 | \$1000 |
|----------------|-----|-----|---------------|

NOTES: Can be used freestanding.

ⓘ Designed to be used with 24"D x 29½"H returns or bridges.

SPECIFYING EXAMPLE: H115811.A.NN

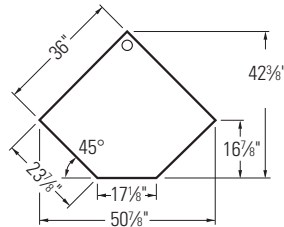

NOTES:

- Shared components shown on this page can be used with modular components shown on pages 154-158, full pedestal models shown on pages 159-160, and 3/4 pedestal models shown on pages 161-162.
- Mobile pedestals, shown on page 170, work well in a variety of configurations.
- Extended corner units (H115815R and H115816L) can be used with 36"W return shell (H115680) to achieve a 6' x 6' layout.
- 36" corner unit (H115811) can be used with two 36"W return shells (H115680) to achieve a 6' x 6' layout.
- For conference table options, see the Preside® table tops and bases in the Tables section in the 2021 Shared Spaces Pricer. Order edge option "K".
- For work-in-process paper management tools, see page 175.
- See pages 163-179 for shared components.

HOW TO SPECIFY

| | | |
|--|--|---|
| <p>Select Model Number</p> <p>H 1 1 5 8 1 7 R .</p> | <p>Select Edge Profile</p> <p>See page 150</p> <p>A .</p> | <p>Select Laminate</p> <p>See page 150</p> <p>NN</p> |
|--|--|---|











VALIDO®

Shared Components & Accessories

GSA SIN 33721

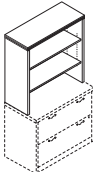

Icon Legend on page 19

| | DESCRIPTION | MODEL | SHIP WEIGHT | CUBE | LIST PRICE |
|---|---|----------------|-------------|------|---------------|
|  | Mobile Pedestal (with core removable lock) — Box/Box/File 15 ³ / ₄ "W x 22 ³ / ₄ "D x 28 ³ / ₈ "H — use freestanding or under 24"D, 30"D and 36"D modular shells NOTES: Top box drawer does not lock. | H115102 | 121 | 8.4 | \$1041 |
|  | Mobile Pedestal (with core removable lock) — File/File 15 ³ / ₄ "W x 22 ³ / ₄ "D x 28 ³ / ₈ "H — use freestanding or under 24"D, 30"D and 36"D modular shells | H115104 | 121 | 8.4 | \$1041 |
|  | Mobile Pedestal (with core removable lock) — Box/File 15 ³ / ₄ "W x 18 ³ / ₄ "D x 21 ¹ / ₈ "H — use freestanding or under 20"D, 24"D, 30"D and 36"D modular shells | H115106 | 68 | 5.8 | \$872 |
|  | Mobile Pedestal — Shelf/Box/File 15 ³ / ₄ "W x 18 ³ / ₄ "D x 28 ³ / ₈ "H — use freestanding or under 20"D, 24"D, 30"D and 36"D modular shells NOTES: All mobile pedestals have a 1 ¹ / ₈ " thick top with flat, non-profiled edge. SPECIFYING EXAMPLE: H115102.C.NN | H115109 | 76 | 7.3 | \$957 |
|  | Lateral File (with core removable lock) 36"W x 24"D x 29 ¹ / ₂ "H — two drawer 36"W x 20"D x 29 ¹ / ₂ "H — two drawer 36"W x 20"D x 45 ¹ / ₂ "H — three drawer 36"W x 20"D x 59 ¹ / ₈ "H — four drawer NOTES: Includes hangrails, mechanical interlock, and in H11563 and H115690, a counterweight. Stack-on storage (H115321) and bookcase hutch (H115292) can be used with H11563 and H115690. Interlock inhibits the extension of more than one drawer from opening at a time. 24"D two-drawer model aligns with the depth of 24"D credenzas and returns. SPECIFYING EXAMPLE: H11563.A.C.NN | H115690 | 199 | 18.4 | \$1459 |
|  | | H11563 | 177 | 15.6 | \$1389 |
|  | | H11517 | 247 | 23.2 | \$2110 |
|  | | H11516 | 312 | 31.0 | \$2941 |
|  | Storage Cabinet with Doors (with core removable lock) 36"W x 24"D x 29 ¹ / ₂ "H 36"W x 20"D x 29 ¹ / ₂ "H NOTES: Includes one adjustable shelf. Shelf adjusts in 1 ¹ / ₄ " increments with a total range of 5"H. Stack-on storage (H115321) and bookcase hutch (H115292) can be used with H115290 or H115291. 24"D model aligns with the depth of 24"D credenzas and returns. SPECIFYING EXAMPLE: H115291.A.C.NN | H115290 | 176 | 18.4 | \$1255 |
|  | | H115291 | 154 | 15.0 | \$1078 |
|  | Bookcase Hutch (for use with lateral file models H11563 or H115690 or storage cabinet with door models H115291 or H115290) 36"W x 14 ³ / ₈ "D x 37 ¹ / ₂ "H NOTES: Cord pass-through gap behind shelves and a 1 ¹ / ₈ "H full-width cord management slot at the bottom of the back panel to facilitate routing cords and reaching wall electrical outlets. When placed on top of 29 ¹ / ₂ "H base unit the total height (67"H) matches the height of credenzas with stack-on storage and the height of the wardrobe/storage cabinets and storage cabinet/lateral file. Two shelves are adjustable in 1 ¹ / ₄ " increments with a total range of 17 ¹ / ₂ "H. SPECIFYING EXAMPLE: H115292.A.NN | H115292 | 108 | 3.8 | \$840 |

NOTES:

- For additional components that can be shared with Valido/11500 Series, see pages 163-179.
- Drawers operate on full extension, ball-bearing suspensions to ensure smooth, quiet, long-lasting operation.
- Versatile mobile pedestals work well in a variety of configurations. Can be used freestanding or under modular shells. 1¹/₈" thick top with a square, non-profiled edge.
- 24"D two drawer lateral file and 24"D storage cabinet with door models align with 24"D credenzas and returns, credenza and return shells as well as wardrobe/storage cabinets to provide linear layout continuity.
- Mobile printer/fax cart shown on page 158 is ideal for limited space.
- File drawer design includes integrated hangrails for side-to-side letter or legal filing; and front-to-back for letter filing.
- Adjustable hex leveling glides allow floor-standing furniture to be easily leveled; glides have 3/4" adjustable range.
- For conference table options, see the Preside® table tops and bases in the Tables section in the 2021 Shared Spaces Pricer. Order edge option "K".

HOW TO SPECIFY**Select Model Number**

H 1 1 5 6 3 .

Select Edge ProfileSee page 150
Not specified for models H115102, H115103 and H115104

A .

Select Handle OptionSee page 150
Not specified for models H115292, H115520, H115523 and H115524

C .

Select Laminate

See page 150

N N

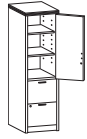

Icon Legend on page 19

Right-hand model
H115297R shown**DESCRIPTION****Storage/File Cabinet (with core removable locks)**

18"W x 24"D x 67"H, Hinged Right (shown)
18"W x 24"D x 67"H, Hinged Left

MODEL**H115297R****H115298L****SHIP WEIGHT**

262

262

CUBE

22.7

22.7

LIST PRICE**\$2278****\$2278**

NOTES: Versatile unit features a storage cabinet and two file drawers. Storage cabinet includes three shelves, two are adjustable in 2½" increments. Door hinged left or right models available. File drawers operate on ball-bearing suspensions with full extension. File drawers have high sides to accept hanging folders in letter or legal size. Drawers standard with hangrails. Both the storage cabinet and the file drawers are equipped with an interchangeable core removable lock. Unit height is designed to match credenza or return plus stack-on storage height.

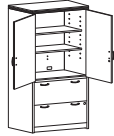
Doors open 110 degrees from
closed position.**Storage Cabinet/Lateral File (with core removable lock)**

36"W x 24"D x 67"H

H115293

373

41.0

\$2953

NOTES: Storage cabinet is standard with one fixed and two full-width adjustable shelves in top compartment; adjustable shelves can be removed. Overall storage compartment measures 31¼"W x 22"D x 36¼"H and will accommodate supplies, books and binders, as well as business machines and electronic equipment. Cord pass-through gap behind shelves and grommet in back of cabinet to facilitate routing cords and reaching wall electrical outlets. Two drawer lateral file on bottom. Lateral file comes with mechanical interlock and hangrails. Cabinet and lateral file lock independently. Unit height is designed to match credenza or return plus stack-on storage height.

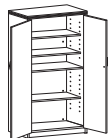
Doors open 110 degrees from
closed position.**Storage Cabinet w/Doors (with core removable lock)**

36"W x 24"D x 67"H

H115299

349

41.0

\$2639

NOTES: Large capacity storage area includes five, full-width (side-to-side) shelves; three are adjustable in 2½" increments. Unit height matches credenza or return plus stack-on storage height.

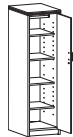
Right-hand model
H115295R shown**Personal Wardrobe/Storage Cabinet (with core removable lock)**

18"W x 24"D x 67"H, Hinged Right (shown)
18"W x 24"D x 67"H, Hinged Left

H115295R**H115296L**

227

227

22.9

22.9

\$1970**\$1970**

NOTES: Unit is standard with four adjustable shelves, coat rod, and core removable lock. Shelves adjust in 2½" increments. Unit height is designed to match credenza or return plus stack-on storage height. Cabinet can be used as a wardrobe by removing four adjustable shelves. Coat rod can be removed from cabinet for storage only applications.

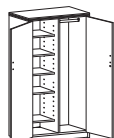
Doors open 110 degrees from
closed position.**Personal Wardrobe/Storage Cabinet (with core removable lock)**

36"W x 24"D x 67"H

H11530

349

41.0

\$2884

NOTES: Spacious design is standard with four adjustable shelves (one shelf is fixed), coat rod and core removable lock which locks both doors. Shelves adjust in 2½" increments. Unit height is designed to match credenza or return plus stack-on storage height.

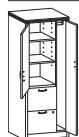
Right-hand model
H115301R shown**Personal Storage Tower (with core removable locks)**

24"W x 24"D x 67"H, Wardrobe Hinged Right, Storage Cabinet Hinged
Left (shown)
24"W x 24"D x 67"H, Wardrobe Hinged Left, Storage Cabinet Hinged
Right

H115301R**H115302L**

304

304

27.9

27.9

\$2884**\$2884**

NOTES: Spacious design includes a wardrobe closet, storage cabinet, and two file drawers in one compact unit. Wardrobe closet contains a coat rod. Storage cabinet includes three shelves, two are adjustable in 2½" increments. Door hinged left or right models available. File drawers operate on ball-bearing suspensions with full extension. File drawers have high sides to accept hanging folders in letter or legal size. Drawers standard with hangrails. Equipped with interchangeable core removable locks. Upper lock secures storage cabinet and wardrobe closet doors; lower lock secures file drawers. Unit height is designed to match credenza or return plus stack-on storage height.

NOTES:

- Adjustable hex leveling glides allow floor-standing furniture to be easily leveled; glides have ¾" adjustable range.
- Locking units equipped with interchangeable core removable locks.
- For conference table options, see the Preside® table tops and bases in the Tables section in the 2021 Shared Spaces Pricer. Order edge option "K".
- See pages 163-179 for shared components.

ⓘ Keyed alike cores must be ordered separately — see model HF23B on page 773.

HOW TO SPECIFY

| Select Model Number | Select Edge Profile | Select Handle Option | Select Laminate |
|---------------------|---------------------|----------------------|-----------------|
| See page 150 | See page 150 | See page 150 | See page 150 |
| H 1 1 5 2 9 7 R . | A . | C . | N N |

VALIDO® Shared Components & Accessories

GSA SIN 33721



Icon Legend on page 19



H11552 shown

DESCRIPTION**Bookcase**

36"W x 13¹/₈"D x 29⁵/₈"H, 2-Shelf
 36"W x 13¹/₈"D x 43³/₈"H, 3-Shelf
 36"W x 13¹/₈"D x 57¹/₈"H, 4-Shelf
 36"W x 13¹/₈"D x 71"H, 5-Shelf

MODEL

H11552
H11553
H11554
H11555

SHIP WEIGHT

94
 126
 160
 191

CUBE

10.2
 15.6
 20.3
 25.3

LIST PRICE

\$722
\$846
\$1006
\$1134

NOTES: Fixed shelves. Inside shelf dimensions on all units is 33³/₄"W x 12"D x 13"H. No assembly required.

SPECIFYING EXAMPLE: H11552.A.NN

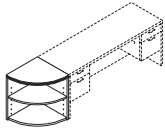
**End Cap Bookshelf**

24"W x 24"D x 29¹/₂"H

H115520

87

2.6

\$847

(2 shelves, 1 fixed, 1 adjustable. Adjusts in 2¹/₂" increments with a total range of 10"H)

NOTES: Unit is freestanding. Designed to be positioned at the end of 24"D credenzas and returns. Holds books and personal items.

SPECIFYING EXAMPLE: H115520.A.NN

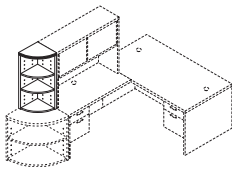
**End Cap Bookshelf**

15"W x 15"D x 37¹/₂"H

H115523

54

2.2

\$749

(3 shelves, 1 fixed, 2 adjustable. Adjusts in 2¹/₂" increments with a total range of 25"H)

NOTES: Unit is designed to be positioned at the end of stack-on storage and on top of model H115520. Combined height of models H115520 and H115523 matches credenza plus stack-on storage height. Can be used freestanding.

SPECIFYING EXAMPLE: H115523.A.NN

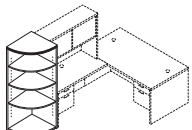
**End Cap Bookshelf**

24"W x 24"D x 67"H

H115524

167

4.8

\$1345

NOTES: Designed to be positioned at the end of 24"D credenzas with stack-on storage, 24"D returns with stack-on storage, 24"D storage/file cabinet, 24"D storage cabinet/lateral file, 24"D wardrobe/storage cabinets, or the 24"D personal storage tower. Unit has four shelves, three are adjustable in 2¹/₂" increments, with a total range of 45"H; bottom shelf is fixed.

SPECIFYING EXAMPLE: H115524.A.NN

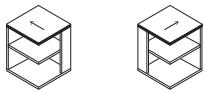

Model H115525R Model H115526L

Square End Cap Bookshelf — 2-Fixed Shelves

24"W x 24"D x 29¹/₂"H, Right
 24"W x 24"D x 29¹/₂"H, Left

H115525R
H115526L

98
 98

3.7
 3.7

\$834
\$834

SPECIFYING EXAMPLE: H115525R.A.NN

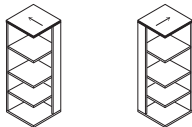

Model H115527R Model H115528L

Square End Cap Bookshelf — 4-Fixed Shelves

24"W x 24"D x 67"H, Right
 24"W x 24"D x 67"H, Left

H115527R
H115528L

178
 178

11.4
 11.4

\$1287
\$1287

SPECIFYING EXAMPLE: H115527R.A.NN

NOTES: Units are freestanding. Designed to be positioned next to 24"D models or as a corner bookcase.

End cap, left: grain direction on top aligns with grain direction on tops of left pedestal returns and left credenza models or when positioned to the left side of credenzas with doors or kneespace models.

End cap, right: grain direction on top aligns with grain direction on tops of right pedestal returns and right credenza models or when positioned to the right side of credenzas with doors or kneespace models.

NOTES:

- Choose from square or rounded versions of the end cap bookshelves.
- End cap bookshelf units are ideal for books, photos and mementos.
- End Cap Bookcases are designed to be positioned at the end of 24"D credenzas and returns.
- Adjustable hex leveling glides allow floor-standing furniture to be easily leveled; glides have 3/4" adjustable range.
- End cap bookshelf units are ideal for books, photos and mementos.
- For conference table options, see the Preside® table tops and bases in the Tables section in the 2021 Shared Spaces Pricer. Order edge option "K".
- See pages 163-179 for shared components.

HOW TO SPECIFY**Select Model Number**

H 1 1 5 5 2 7 R .

Select Edge Profile

See page 150

A .

Select Laminate

See page 150

N N

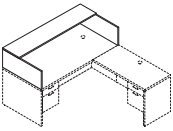
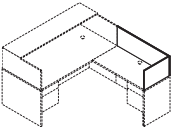
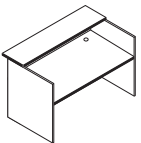
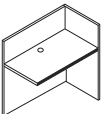
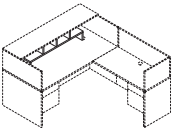
| | DESCRIPTION | MODEL | SHIP WEIGHT | CUBE | LIST PRICE |
|--|--|----------------|-------------|------|---------------|
|  | Reception Station with Transaction Counter for 72"W x 36"D Desk, or Desk Shell, with rectangle top 72"W x 36"D x 14 ⁵ / ₈ "H | H115720 | 100 | 3.0 | \$804 |
| | NOTES: For desk tops without grommets, see field installable grommet kit, model HFLDGRMT or HFLDGRMT3 on page 177. Transaction counter organizer (HTCOL52) fits under/inside of transaction counter (see below). | | | | |
|  | Reception Station for 42"W x 24"D Return or Return Shell 42"W x 24"D x 13"H | H105722 | 21 | 1.0 | \$269 |
| | Reception Station for 48"W x 24"D Return or Return Shell 48"W x 24"D x 13"H | H105721 | 25 | 3.6 | \$306 |
| | NOTES: For return tops without grommets, see field installable grommet kit, model HFLDGRMT or HFLDGRMT3 on page 177. ⚠ Not available in two tone laminate. | | | | |
|  | Reception Desk Shell 72"W x 39 ⁷ / ₈ "D x 44 ¹ / ₈ "H | H115724 | 328 | 16.8 | \$1610 |
| | NOTES: Non-handed design. Integrated 18 ⁵ / ₈ "D transaction counter with a 4" full-width overhang. Two cord management grommets in top for routing and hiding wires and cables. Transaction counter organizer (HTCOL52) fits under/inside of transaction counter. | | | | |
|  | Reception Return Shell 42"W x 24"D x 43 ⁵ / ₈ "H | H115726 | 140 | 16.8 | \$1045 |
| | NOTES: Non-handed design. Attaches to reception desk shell to form an L-shaped workstation. One cord management grommet in top for routing and hiding wires and cables. Woodgrain on approach side is vertical to match grain direction on end panels of reception desk. | | | | |
|  | Transaction Counter Organizer 48 ³ / ₄ "W x 11 ¹ / ₈ "D x 13"H | HTCOL52 | 24 | 1.1 | \$300 |
| | NOTES: Fits under reception station with transaction counter model H115720 or reception desk shell H115724. ⚠ Black only. | | | | |

NOTES:

- Two welcoming reception station designs to choose from — stack-on enclosure or full-to-floor shell.
- See pages 163-179 for shared components.

HOW TO SPECIFY





| | | |
|---|---|---|
| Select Model Number <div style="border: 1px solid black; padding: 2px; display: flex; gap: 5px;"> H115724 </div> | Select Edge Profile See page 150 <div style="border: 1px solid black; padding: 2px; display: flex; gap: 5px;"> A </div> | Select Laminate See page 150 <div style="border: 1px solid black; padding: 2px; display: flex; gap: 5px;"> NN </div> |
|---|---|---|

VALIDO® Shared Components & Accessories

GSA SIN 33721 EXCEPT AS NOTED

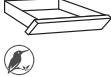
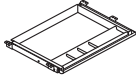
ABI

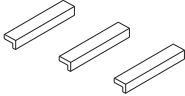
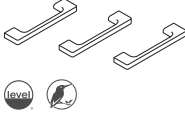
Icon Legend on page 19

| | DESCRIPTION | MODEL | SHIP WEIGHT | CUBE | LIST PRICE |
|--|---|--------------------------------------|--------------------|-------------|----------------------------------|
|  | Angled Wood Center Drawer | | | | |
| | 26" x 15 ³ / ₈ " 22" x 15 ³ / ₈ " | H1526 H1522 | 12.0 Ⓢ 11.0 Ⓢ | 1.2 1.1 | \$214 \$199 |
| | NOTES: Specify laminate for drawer. For additional information see the Workplace Tools section in the 2021 Shared Spaces Pricer. | | | | |
|  OPEN MARKET | Polymer Center Drawer | HCD1 | 7.0 | 0.5 | \$126 |
| | <ul style="list-style-type: none"> Color: Black. Material: ABS. Minimum clearance for mounting: 23"W x 16¹/₄"D x 2"H. Retracts on 16" ball-bearing slides. Can be used on worksurfaces with Coordinate™ Height Adjustable Bases as long as it is attached with spacer model HKBS. Can store up to 25 lbs. | | | | |
| | ⓘ Black finish only, no specification needed. | | | | |
|  | Black Removable Lock Core Kit — see page 773. | HF23B | 0.1 Ⓢ | 0.1 | \$35 |
| | NOTES: Lock with a removable cylinder that can be interchanged as needed; allows users to access all furniture pieces in an office with a single key for convenience and security. Makes re-keying quick and easy. For use in all Valido® Series product lock cores, except the stack-on and wall mounted storage "K" models. For the latter, use lock core kit model HF27B. | | | | |
|  | Field Installable Drawer/Door Handle Kits (fit Valido® 96mm hole spacing) | | | | |
| | Linear, Black, 2-pack Linear, Matte Chrome, 2-pack | HLINEARA2 HLINEARC2 | 0.4 Ⓢ 0.4 Ⓢ | 0.3 0.3 | \$61 \$61 |
| | Linear, Black, 3-pack Linear, Matte Chrome, 3-pack | HLINEARA3 HLINEARC3 | 0.5 Ⓢ 0.5 Ⓢ | 0.3 0.3 | \$69 \$69 |
| | NOTES: The Linear and Arch handles attach using the same 96mm hole spacing as the Valido® Sweep and Crescent handles. The Linear handle is not recommended for use on the Valido® Narrow/Box/Box/File Modular Pedestal — model H115093. | | | | |
|  | Arch, Black, 2-pack Arch, Matte Chrome, 2-pack | HARCHA2 HARCHC2 | 0.4 Ⓢ 0.4 Ⓢ | 0.3 0.3 | \$61 \$61 |
| | Arch, Black, 3-pack Arch, Matte Chrome, 3-pack | HARCHA3 HARCHC3 | 0.5 Ⓢ 0.5 Ⓢ | 0.3 0.3 | \$69 \$69 |
| | ⓘ Must be ordered with a configurable end product. If ordered separately, not on GSA contract. | | | | |
| | DESCRIPTION | MODEL | SHIP WEIGHT | CUBE | LIST PRICE BY PAINT GRADE |
|  | Slide-Away Keyboard Platform (Specify: Laminate) | H4022 | 10 Ⓢ | 0.6 | \$228 |
| | Extended Tray Slide-Away Keyboard Platform (Specify: Laminate) | HE4022 | 12 Ⓢ | 0.7 | \$323 |
| | Metal Keyboard and Mouse Tray (Specify paint) | H4028 OPEN MARKET | 11 Ⓢ | 1.5 | \$164 |
| | Metal Keyboard Tray (Specify paint) | H4029 OPEN MARKET | 11 Ⓢ | 1.5 | \$148 |
| | NOTES: For additional information see the Workplace Tools section in the 2021 Shared Spaces Pricer. | | | | |
| | Refer to the Workplace Tools section in the 2021 Shared Spaces Pricer for additional product information | | | | |

NOTES:

- Linear and Arch field installable handles attach using Valido® 96mm (approx. 3³/₄") hole spacing. No drilling required.
- Center drawers ideal for pens, pencils and other miscellaneous storage. Feature ball-bearing slide suspension.
- For conference table options, see the Preside® table tops and bases in the Tables section in the 2021 Shared Spaces Pricer. Order edge option "K".

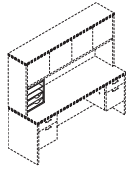

Not available in two-tone laminates

DESCRIPTION**Vertical Paper Manager**14⁷/₈"W x 10⁷/₈"D x 19¹/₁₆"H**MODEL****HLVPM1****SHIP WEIGHT**

27

CUBE

2.8

LIST PRICE**\$351**

NOTES: Keeps papers, files, and books neatly organized and within easy reach from a seated position. Designed for desk, credenza, and return tops. Fits under stack-on storage models. Two pullout drawers and three fixed shelves. Not available in pattern laminate colors. Ships fully assembled. For additional information see the Workplace Tools section in the 2021 Shared Spaces Pricer.

! When used in conjunction with wall mounted storage cabinets, the top of the wall mounted storage cabinets must be positioned a minimum of 68³/₈" above the floor.

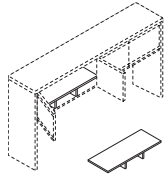
SPECIFYING EXAMPLE: HLVPM1.N**Stacked Paper Management**32¹/₂"W x 12⁵/₈"D x 4¹/₄"H**HLVPM2**

22

1.25

\$175

NOTES: Segments and organizes stack-on and wall mount storage compartments, as well as bookcase shelves. Unit can be used in Models H115327, H11534, H115322, H115321, H115382 and H115381. In some cases, installation may require removing the stack-on or wall mount storage doors. For additional information see the Workplace Tools section in the 2021 Shared Spaces Pricer.

! Black (P) only.

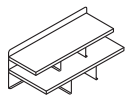

Not available in two-tone laminate

**Desktop Storage Terrace**26¹/₂"W x 12¹/₂"D x 10¹/₂"H**HLDST1**

24

1.1

\$329

NOTES: Keeps work-in-process, priority files, loose pages, and mail neatly organized and in view. Mixed material design comprised of sturdy laminate shelves with metal back and support panels. Not available in two-tone laminate combination or pattern laminate colors. Choose from Platinum Metallic (TI), Black (P), and Charcoal (S) for the metal components.

Sized to fit in stack-on and wall mounted storage cabinets in 10500, 10700, Valido, 94000, and 38000 Series. Fits in Voi stack-on and overhead cabinets except for 48"W or smaller sliding door models. For additional information see the Workplace Tools section in the 2021 Shared Spaces Pricer.

Specify: Model.Laminate.Paint

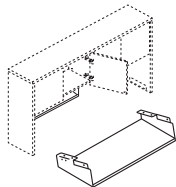
SPECIFYING EXAMPLE: HLDST1.N.TI**Hanging Paper Shelf**28¹/₁₆"W x 11⁷/₁₆"D x 4⁵/₁₆"H**HHPS1**

7

2.9

\$214

NOTES: Maximizes worksurface space; de-clutters desktop while placing priority communications and active project folders within easy reach. Angled design allows contents to be distinguished at a glance. Mixed material styling features strong painted metal frame with a frosted shelf.

Attaches quickly and easily to stack-on and wall mount storage models in the following series: 10500, 10700, Valido, 94000, and Voi (except the 36"W overhead hutch with O-legs or panel mount brackets). Not for use with 38000 Series.

For additional information see the Workplace Tools section in the 2021 Shared Spaces Pricer.

Specify: Model.Paint

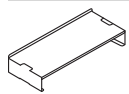
SPECIFYING EXAMPLE: HHPS1.TI**Desktop Paper Shelf**28¹/₁₆"W x 11⁵/₁₆"D x 5"H**HDPS1**

7

2.9

\$214

NOTES: Organizer shelf provides a place and space for work-in-process and piling to keep worksurfaces neat and tidy. Convenient, scalable design with interlocking side supports allow two units to be stacked and integrated. Durable painted metal frame with a frosted shelf; mixed material styling matches hanging paper shelf.

Can also be used inside select overhead storage, including the following stack-on with hinged door models: 10500 and Valido 36", 42", 66", 72", 78"W and 10700 68⁵/₈"W.

For additional information see the Workplace Tools section in the 2021 Shared Spaces Pricer.

Specify: Model.Paint

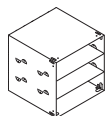
SPECIFYING EXAMPLE: HDPS1.TI**Storage Cube**

12"W x 12"D

HLSL1212

1

0.3

\$316**SPECIFYING EXAMPLE: HLSL1212.P8S****HOW TO SPECIFY****Select Model Number**

H L V P M 1 .

Select Laminate

See page 150

N

VALIDO® Shared Components & Accessories

OPEN MARKET EXCEPT AS NOTED

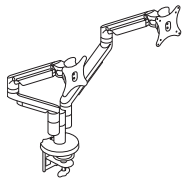

Icon Legend on page 19

**DESCRIPTION****Dual Dynamic Monitor Arm**

- 150° of rotation at base with optional 360° rotation.
- Arms extend 22" and retract up to 3".
- Monitor mount rotates 180° and tilts +/-30°.
- Monitor can be rotated from landscape to portrait position.

! Arms hold monitors from 6.2-18 lbs. Optional counterweight HPACW available to support monitors as low as 5 lbs. (see the Workplace Tools section in the 2021 Shared Spaces Pricer).

MODEL**HMASD****SHIP WEIGHT**

17.0

CUBE

1.1

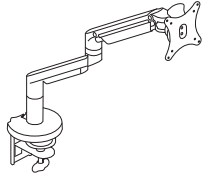
LIST PRICE**\$962****Single Dynamic Monitor Arm**

- 180° of rotation at base with optional 360° rotation.
- Arms extend 22" and retract up to 3".
- Monitor mount rotates 180° and tilts +/-30°.
- Monitor can be rotated from landscape to portrait position.

! Arms hold monitors from 6.2-18 lbs. Optional counterweight HPACW available to support monitors as low as 5 lbs. (see the Workplace Tools section in the 2021 Shared Spaces Pricer).

HMASTS

11.5

0.8

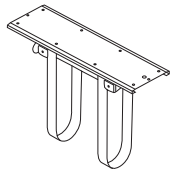
\$501**360° Swivel CPU Holder with Adjustable Straps**

- Supports CPUs 3¾" wide up to 64" perimeter and holds up to 75 lbs.
- 360° rotation.
- Ships complete and includes necessary mounting hardware and instruction sheet.

! Available in Black only, no specification needed.

HCPU1

7.0

0.2

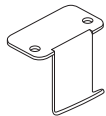
\$260**SIN 33721****Back Pack Hook (10 per carton)**

12"W x 14½"D x 1½"H

HCLA65

10.0

0.1

\$101

NOTES: Assembly: attaches to bottom of desk with (2) screws, included.

! Available in Platinum Metallic finish only, no specification needed.

**NOTES:**

- See the Workplace Tools section in the 2021 Shared Spaces Pricer for additional monitor arm models.

HOW TO SPECIFY

| | |
|---|---|
| Select Model Number <div style="border: 1px solid black; padding: 2px; display: flex; gap: 5px;"> HMASD </div> | Select Finish <i>Specify for models HMASD and HMASTS only</i> SVR Silver BLK Black <div style="border: 1px solid black; padding: 2px; display: flex; gap: 5px;"> SVR </div> |
|---|---|



Icon Legend on page 19

Shared Components & Accessories

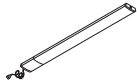

OPEN MARKET

DESCRIPTION

LED Task Lights

- 17" LED Light with Power Supply (Single)
- 31" LED Light with Power Supply (Single)
- 17" LED Light with Power Supply for Daisy-chain (Starter)
- 31" LED Light with Power Supply for Daisy-chain (Starter)
- 17" LED Light with 8" Jumper Cord for Daisy-chain (Follower)
- 31" LED Light with 8" Jumper Cord for Daisy-chain (Follower)

MODEL

- HLED17AS** ⓘ
- HLED31AS** ⓘ
- HLED17A**
- HLED31A**
- HLED17AUO** ⓘ
- HLED31AUO** ⓘ

SHIP WEIGHT

- 1.2
- 1.5
- 1.0
- 1.4
- 1.0
- 1.0

CUBE

- 0.05
- 0.09
- 0.05
- 0.09
- 0.03
- 0.05

LIST PRICE

- \$450**
- \$603**
- \$493**
- \$662**
- \$404**
- \$539**

Undercabinet Occupancy Sensor with 1" End to End Connector

HLEDOSA ⓘ

0.2

0.01

\$97

NOTES: To use the daisy chain application, must start with model HLED17A or HLED31A. No finish specification required. Attaches magnetically to underside of overhead storage, or attaches with provided screws or double-sided tape. Occupancy sensor attaches to a single or starter LED light and will automatically turn the light off after no motion is detected for 30 minutes. Just like all the LED light models, the occupancy sensor features a soft-touch on/off switch. LED task lights have a lifetime of 50,000 hours and have a dimmer feature that allows the user to adjust the amount of light output.



Refer to page 111

OPEN MARKET

Recessed Task Light

- 46 1/2"W x 3 1/16"D x 1 1/8"H for Models H115327, H11534, H11533 and H115324
- 34 3/8"W x 3 1/16"D x 1 1/8"H for Models H115323, H115322, H115382 and H115383
- 22 1/8"W x 3 1/16"D x 1 1/8"H for Models H115321, H115380 and H115381

- HH870960**
- HH870942**
- HH870930**

- 12.0
- 10.0
- 7.0

- 1.1
- 0.9
- 0.6

- \$290**
- \$267**
- \$247**

NOTES: For additional information see the Workplace Tools section in the 2021 Shared Spaces Pricer.



LED Task Lights

- Articulating Desk Lamp**
- Articulating Desk Lamp w/ Occupancy Sensor**

- HLED1**
- HLED1OC**

- 1.2
- 1.2

- 6.5
- 6.5

- \$430**
- \$524**

NOTES: For additional information see the Workplace Tools section in the 2021 Shared Spaces Pricer.

Task Desk Lamp

HLED2

0.7

3.0

\$373

NOTES: For additional information see the Workplace Tools section in the 2021 Shared Spaces Pricer.



Black only

Field Installable Grommet

- Grommet is field installable.
- Grommet shape is round.
- Includes grommet cap and sleeve.

- Grommet cap measures 3" diameter and includes a 3/4" diameter cord access hole.
- Grommet sleeve measures 2 1/2" O.D. x 3/4" thick.
- Includes instructions to locate grommet position for desks, credenzas, returns and bridges.

HFLDGRMT

0.1

0.01

\$35

NOTES: For additional information see the Workplace Tools section in the 2021 Shared Spaces Pricer.

- ⓘ Designed to be used in top and end panels to route/hide cords, and in modesty panels to facilitate reaching wall electrical outlets.
- ⓘ Black Finish
- ⓘ Requires a 2 1/2" diameter hole saw and drill for installation (not included).



Field Installable Grommet

- Grommet is field installable.
- Grommet shape is round.
- Includes grommet cap and sleeve.

- Grommet outside dimensions measure 3 1/2" diameter and includes two cord access holes.
- Grommet sleeve measures 3" O.D. x 1" thick.
- Includes instructions to locate grommet position for desks, credenzas, returns and bridges.

HFLDGRMT3

0.1

0.3

\$35

NOTES: For additional information see the Workplace Tools section in the 2021 Shared Spaces Pricer.

- ⓘ Designed to be used in top and end panels to route/hide cords, and in modesty panels to facilitate reaching wall electrical outlets.
- ⓘ Black Finish
- ⓘ Requires a 3" diameter hole saw and drill for installation (not included).

NOTES:

- See pages 163-179 for shared components.

HOW TO SPECIFY

Select Model Number

H H 8 7 0 9 6 0 .

Select Color

Available in Black (P) only

P

VALIDO® Shared Components & Accessories

GSA SIN 33721T EXCEPT AS NOTED

ABI

Icon Legend on page 19

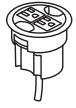
**DESCRIPTION****MODEL****SHIP WEIGHT****CUBE****LIST PRICE****Power Hub, 3" Grommet Mount, 6' Cord****HGRMTAC**

1.3

0.2

\$126

- Fits in 3" round grommet holes on the following product lines: 10500, 10700, Concinnity, Coordinate, and Voi desks; Abound Worksurfaces; Huddle and Motivate tables and SmartLink.
- Two grounded AC power outlets.
- Includes 6' cord with three-prong plug.
- Two cord pass-through holes in cap.
- Field installed; easy plug-and-play.
- UL Listed.

NOTES: For additional information see the Workplace Tools section in the 2021 Shared Spaces Pricer.

! Available in black only (no color designation so use .X - Specify: HGRMTAC.X).

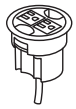
**3" Round Power Grommet - 2 Outlets, 10' Cord****HGRMTAC2**

1.5

0.2

\$159

- Includes 10' cord with three-prong plug.
- Fits in 3" round grommet holes on the following product lines: Coordinate, Huddle, Motivate, all laminate casegoods series, and Systems Worksurfaces.
- Two grounded AC power outlets.
- Field installed with Plug-and-play ease.

NOTES: Power Modules will also work with standing-height applications for 10500 Series™ and Voi® desks. Optional Memory Control allows preset worksurface heights for consistency. Ships separately. Dynamic load capacity when worksurface is moving is 300 lbs.

! Available in black finish only, no specification needed.

**Power/USB Hub, 3" Grommet Mount****HGRMTUSB2**

1.3 Ⓢ

0.02

\$250

- One grounded AC power outlet with 2 USB ports.
- Two cord pass-through holes in cap.
- Includes 6' cord with three-prong plug.
- Field installed; easy plug-and-play.
- UL Listed.

NOTES: For additional information see the Workplace Tools section in the 2021 Shared Spaces Pricer.

! Available in black only (no color designation so use .X - Specify: HGRMTUSB2.X).

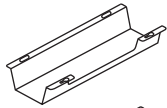
**Cable Management Troughs**

17"W - Single

HCTROUGH17

2.7 Ⓢ

0.5

\$73

17"W - 10-Pack

HCTROUGH1710

14.0 Ⓢ

0.5

\$665

36"W - Single

HCTROUGH36

4.9 Ⓢ

0.9

\$122

36"W - 10-Pack

HCTROUGH3610

30.0 Ⓢ

0.9

\$1121

- Cable management troughs ship flat packed.
- The troughs attach to underneath the worksurface with screws.
- The 17"W has one wire access cut out on the user side. The 36" has two wire access cut outs. These cut outs give users access to inside the trough without having to detach it from the worksurface.
- Color: Graphite.
- Material: Metal.
- TAA Compliant.

NOTES: For additional information see the Workplace Tools section in the 2021 Shared Spaces Pricer.

SIN 33721

HOW TO SPECIFYSelect
Model Number

H G R M T A C

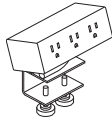

Model HPWRMOD3WC shown

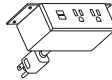

Model HPWRMOD2UWM shown

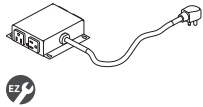
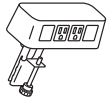

| DESCRIPTION | MODEL | SHIP WEIGHT | CUBE | LIST PRICE |
|---|--------------------|-------------|------|--------------|
| Power Modules | | | | |
| 3 Receptacles with Worksurface Clamp | HPWRMOD3WC | 2.3 | 0.2 | \$342 |
| 3 Receptacles with Under-Worksurface Mounting Bracket | HPWRMOD3UWM | 2.3 | 0.2 | \$342 |
| 2 Receptacles 2 USB with Worksurface Clamp | HPWRMOD2WC | 2.3 | 0.2 | \$546 |
| 2 Receptacles 2 USB with Under-Worksurface Mounting Bracket | HPWRMOD2UWM | 2.3 | 0.2 | \$546 |
| <ul style="list-style-type: none"> • 6' power cord with standard three-prong plug. • Under-worksurface mounting bracket models work with any top that has a 5" x 5" square clearance. • Worksurface clamp models work on any top with a 4" overhang. • UL Listed. <p> Color finish coordinates with HON's Charcoal or White. Specify <i>STRM</i> for Storm or <i>SNW</i> for Snow when ordering. Example: <i>HPWRMOD3WC.STRM</i>.</p> | | | | |
| Power & Data Center | | | | |
| 2 Receptacles 2 Data Accessory | HCOMDOME2 | 2.5 | 0.2 | \$327 |
| <ul style="list-style-type: none"> • Standard with two receptacles and openings for two data ports. • 6' power cord with standard three-prong plug. • Fits on any worksurface with a 4" overhang. • UL Listed. <p> Color finish coordinates with HON's Loft. Specify <i>LOFT</i> when ordering. Example: <i>HCOMDOME2.LOFT</i>.</p> | | | | |
| Under Worksurface Power Module — 4 Outlets, 10' Cord | | | | |
| | HPWRMOD2 | 1.5 | 0.2 | \$441 |
| <ul style="list-style-type: none"> • Includes 10' cord with three-prong plug. • Fits in cable management troughs. See page 178. • 4 outlets on side create easy access. <p>NOTES: Power Modules will also work with standing-height applications for 10500 Series™ and Voi® desks.</p> <p> Available in black finish only, no specification needed.</p> | | | | |
| Vertebrae | | | | |
| | HMPVWM28 | 3.0 | 0.3 | \$246 |
| <p>NOTES: 30"H x 3 3/8"W x 1 1/2"D. Ships unassembled.</p> <p> Clear finish. Specify "X" for finish option. SPECIFYING EXAMPLE: HMPVWM28.X</p> | | | | |

NOTES:

- For additional information see the Workplace Tools section in the 2021 Shared Spaces Pricer.

HOW TO SPECIFY

Select Model Number

H P W R M O D 3 W C



DESCRIPTION

MODEL

SHIP WEIGHT

CUBE

LIST PRICE

Coordinate™ Portable Desktop Riser
31"D x 5"-16½"H x 35"W

HBXRISER

54.0

4.1

\$657

NOTES: Available in Black (BLK) or White (WHT) finish. Desktop riser dimensions (without keyboard tray): 22"D x 5"-16½"H x 35"W. Keyboard tray dimensions: 9"D x 30"W. Max loading capacity is 33 lbs for the desktop riser surface and 4 lbs for the keyboard tray. Easily transition from seated to standing positions throughout the workday. Sits atop an existing desk to create sit-to-stand functionality by raising the computer. Includes keyboard tray and surface for computer monitors. **HON 5-Year Limited Warranty.**

⚠ Not intended for use on mobile workstations.

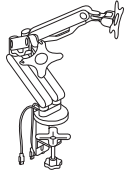

Dual Monitor Arm with 2 USB Ports

HBDMAUSB

41.9

2.6

\$410

NOTES: Easy adjustment. Height adjusts to 17" tall. Monitor tilt and swivel capability. Enclosed cable management. Grommet or desktop mounting. Clean appearance. In some applications the Monitor Arms may extend 12 or more inches into the worksurface. For additional information see the Workplace Tools section in the 2021 Shared Spaces Pricer. **HON 5-Year Limited Warranty.**

⚠ No specification needed.

HOW TO SPECIFY

Select Model Number

Select Finish

BLK Black
WHT White

HBXRISER.

BLK

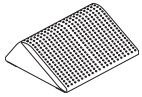

| | DESCRIPTION | MODEL | SHIP WEIGHT | CUBE | LIST PRICE |
|---|--|---------------|-------------|------|-------------|
|  | Footrest — Anti-Slip Cover 13¾"D x 5½"H x 16"W ⓘ Available in Black (T) finish ONLY. Recommended weight capacity not to exceed 250 pounds. HON 5-Year Limited Warranty. SPECIFYING EXAMPLE: HVL991.T | HVL991 | 7 ⓘ | 0.9 | \$89 |

HOW TO SPECIFY

| | |
|---|--|
| <p>Select Model Number</p> <p>H V L 9 9 1 .</p> | <p>Select Finish</p> <p>T Black</p> <p>T</p> |
|---|--|

VOI®

Want to see more? Scan here
to check out hon.com.



Voi® shown with Ignition® Seating.

VOI®

Voi gets you. Your needs. Your style. Your environment. Voi packs a lot of functionality into a little space, so you can maximize yours. Plus, versatile Voi integrates easily with a variety of spaces, systems — even open plans. Solidly built and strikingly designed, Voi combines classic warmth and contemporary cool with an extensive variety of laminates, colors, components and configurations. So you can create a sophisticated, professional look that is uniquely yours.



FEATURES

- Big. Small. Functional. Adaptable. Voi has multiple options to meet your storage needs and available space.
- To create an office look that's uniquely yours, mix things up — with tasteful modesty panels, stylish storage cubes and mixed surface materials.
- Refined scale. Layered workspaces. Together they help streamline your office to create small-footprint spaces that work BIG.
- With so many configurations and combinations, Voi® makes it easy to create a stylish, unified look across your entire office.

VOI® ORDERING INFORMATION

WORKSURFACES

L1 LAMINATES CODES

Woodgrain

- ◆ Bourbon Cherry H
- ◆ Cognac COGN
- ◆ Florence Walnut LFW1
- ◆ Harvest C
- ◆ Kingswood Walnut LK1I
- ◆ Mahogany N
- ◆ Mocha MOCH
- ◆ Natural Maple D
- ◆ Pinnacle PINC
- ◆ Shaker Cherry F
- ◆ Sterling Ash LSA1

Solid

- ◆ Black P
- ◆ Charcoal S
- ◆ Designer White LDW1
- ◆ Loft LOFT

Patterned

- ◆ Handspun Chestnut LAHC
- ◆ Handspun Dove LAHD
- ◆ Handspun Pearl LAHP
- ◆ Handspun Slate LAHS
- ◆ Sheer Mesh* A5
- ◆ Silver Mesh** B9

L2 LAMINATES*** CODES

Woodgrain

- ◆ Lowell Ash LLA1
- ◆ Natural Recon LNR1
- ◆ Phantom Ecu LPE1
- ◆ Portico Teak LPT1
- ◆ Skyline Walnut LSW1

WORKSURFACE EDGE BAND

Woodgrain

- ◆ Bourbon Cherry H
- ◆ Cognac COGN
- ◆ Florence Walnut FW
- ◆ Harvest C
- ◆ Kingswood Walnut KI
- ◆ Lowell Ash DL
- ◆ Mahogany N
- ◆ Mocha MOCH
- ◆ Natural Maple D
- ◆ Natural Recon NR
- ◆ Phantom Ecu PE
- ◆ Pinnacle PINC
- ◆ Portico Teak DP
- ◆ Shaker Cherry F
- ◆ Skyline Walnut SW
- ◆ Sterling Ash SA

Solid

- ◆ Black P
- ◆ Brownstone EY
- ◆ Charcoal S
- ◆ Designer White DW
- ◆ Fossil EH
- ◆ Greige R
- ◆ Light Gray Q
- ◆ Loft LOFT
- ◆ Muslin T
- ◆ Platinum K
- ◆ Shadow* SHDW

CHASSIS/CABINET DRAWER/DOOR FRONTS, LAMINATE END PANELS, LAYERING SHELVES AND MODESTY PANELS

L1 LAMINATES CODES

Woodgrain

- ◆ Bourbon Cherry H
- ◆ Cognac COGN
- ◆ Florence Walnut LFW1
- ◆ Harvest C
- ◆ Kingswood Walnut LK1I
- ◆ Mahogany N
- ◆ Mocha MOCH
- ◆ Natural Maple D
- ◆ Pinnacle PINC
- ◆ Shaker Cherry F
- ◆ Sterling Ash LSA1

Solid

- ◆ Black P
- ◆ Charcoal S
- ◆ Designer White LDW1
- ◆ Loft LOFT

L2 LAMINATES*** CODES

Woodgrain

- ◆ Lowell Ash LLA1
- ◆ Natural Recon LNR1
- ◆ Phantom Ecu LPE1
- ◆ Portico Teak LPT1
- ◆ Skyline Walnut LSW1

WORKSURFACE GROMMETS

PLASTIC CODES

- ◆ Black P
- ◆ Brownstone EY
- ◆ Charcoal S
- ◆ Designer White DW
- ◆ Fossil EH
- ◆ Greige R
- ◆ Loft LOFT
- ◆ Muslin T3
- ◆ Platinum T1
- ◆ Shadow* SD
- ◆ Titanium T1

PULLS & FEET

PAINT CODES

P1

- ◆ Black P
- ◆ Designer White PJW

P2

- ◆ Champagne Metallic T4
- ◆ Platinum Metallic T1
- ◆ Silver PR6
- ◆ Solar Black P8X

O-LEGS, STEEL LEGS, POST LEGS, SHELF BRACKETS, SHARED LEGS, STORAGE CUBES

PAINTS CODES

P1

- ◆ Black P
- ◆ Brownstone P7D
- ◆ Charcoal S
- ◆ Designer White PJW
- ◆ Fossil P28
- ◆ Greige T5
- ◆ Loft LOFT
- ◆ Muslin T3
- ◆ Shadow* SHDW
- ◆ Titanium P8T

P2

- ◆ Champagne Metallic T4
- ◆ Platinum Metallic T1
- ◆ Silver PR6
- ◆ Solar Black P8X

O-LEGS, STEEL LEGS, POST LEGS, SHELF BRACKETS, SHARED LEGS, STORAGE CUBES *continued*

PAINTS CODES

P3

- ◆ Amethyst P091
- ◆ Atom P8S
- ◆ Blossom**** P8K
- ◆ Bullseye PJF
- ◆ Cabernet***** P7T
- ◆ Cobalt Mica P090
- ◆ Conifer***** P8H
- ◆ Ember P8P
- ◆ Ion P8N
- ◆ Iris P8J
- ◆ Krypton P8F
- ◆ Ochre P093
- ◆ Regatta P8M
- ◆ Sienna P092
- ◆ Succulent**** P8A

ANGLED WOOD LEGS

- ◆ Clear Ash LA400
- ◆ Medium Ash LA484

| WORKSURFACE LAMINATES | CODES | EDGE BAND OPTIONS | | | | |
|-----------------------|-------|-------------------|---------------------|-------------|------------|-----------|
| | | Matching Edge | Designer White (DW) | Loft (LOFT) | Muslin (T) | Black (P) |
| Black | P | | | | | • |
| Bourbon Cherry | H | • | • | | • | |
| Charcoal | S | • | | | | |
| Cognac | COGN | • | • | | • | |
| Designer White | LDW1 | | • | | | |
| Harvest | C | • | • | | • | |
| Loft | LOFT | | | • | | |
| Lowell Ash | LLA1 | • | • | • | • | |
| Mahogany | N | • | | • | | |
| Mocha | MOCH | • | • | | • | |
| Natural Maple | D | • | • | • | • | |
| Natural Recon | LNR1 | • | • | • | • | |
| Phantom Ecu | LPE1 | • | • | • | • | |
| Pinnacle | PINC | • | • | | • | |
| Portico Teak | LPT1 | • | • | • | • | |
| Shaker Cherry | F | • | • | • | • | |
| Sheer Mesh | A5 | | | | • | |
| Silver Mesh | B9 | | | • | | |
| Skyline Walnut | LSW1 | • | • | • | • | |
| Sterling Ash | LSA1 | • | • | • | | • |
| Kingswood Walnut | LK1I | • | • | • | • | • |
| Florence Walnut | LFW1 | • | • | • | • | • |

* Sheer Mesh laminate will have Muslin Edgeband. Sheer Mesh NOT available on Chassis/Cabinet, Drawer/Door Fronts, Laminate End Panels, Layering Shelves and Modesty Panels.

** Silver Mesh laminate will have Loft Edgeband. Silver Mesh NOT available on Chassis/Cabinet, Drawer/Door Fronts, Laminate End Panels, Layering Shelves and Modesty Panels.

*** Storage chassis that are specified in L2 laminates and are longer than 60" W will ship with back panels that are horizontal grain.

**** TREND COLORS: These colors are intended to be an inspirational option for the trending market. Product application is limited and color availability is approximately two years to coincide with evolving workplace trends.

◆◆◆ For lead time information see page 19.

* De-emphasized

VOI® Laminate Typicals



Icon Legend on page 19

| QTY | DESCRIPTION | MODEL | LIST PRICE | PRICE EXTENSION |
|---------------|--|-------------|----------------|-----------------|
| 1 | External Channel 54"W | HLSLZ5SC66 | \$110 | \$110 |
| 1 | Rectangle Worksurface 24"D x 66"W | HLSLR2466 | \$428 | \$428 |
| 1 | Low Credenza (Right hand drawers) 60"W x 20"D x 21½"H | HLSL2060LR2 | \$1,412 | \$1,412 |
| 1 | Layering Shelf 60"W x 14½"D x 5½"H | HLSL1460LS | \$410 | \$410 |
| 2 | O-Leg Support for Worksurface (1 pack) 24"D x 28½"H | HLSL24280 | \$357 | \$714 |
| 1 | Overhead Cabinet with Wall Bracket with One Sliding Door 60"W x 14¼"D x 14"H | HLSL1460S | \$1,451 | \$1,451 |
| TOTAL: | | | \$4,525 | |

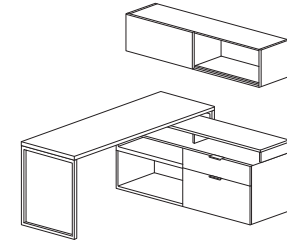
**SMALL FOOTPRINT****66" x 60"**

| QTY | DESCRIPTION | MODEL | LIST PRICE | PRICE EXTENSION |
|---------------|--|-------------|----------------|-----------------|
| 1 | External Channel 54"W | HLSLZ5SC66 | \$110 | \$110 |
| 1 | Rectangle Worksurface 24"D x 66"W | HLSLR2466 | \$428 | \$428 |
| 1 | Low Credenza (2 file/2 box) 60"W x 20"D x 21½"H | HLSL2060LD4 | \$1,647 | \$1,647 |
| 2 | O-Leg Support for Worksurface (1 pack) 24"D x 28½"H | HLSL24280 | \$357 | \$714 |
| 1 | Overhead Cabinet with 4 Doors 60"W x 14¼"D x 14"H | HLSL1460D | \$1,301 | \$1,301 |
| 1 | O-Leg Support for Overhead Cabinet 14½"D x 20½"H for 65"H Overhead Cabinet | HLSL650S | \$526 | \$526 |
| TOTAL: | | | \$4,726 | |

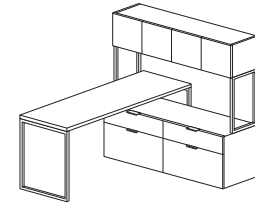
**SMALL FOOTPRINT****66" x 60"**

| QTY | DESCRIPTION | MODEL | LIST PRICE | PRICE EXTENSION |
|---------------|--|--------------|----------------|-----------------|
| 1 | Low Credenza, Right Hand Drawers, Footed 60"W x 20"D x 24½"H | HLSL2060LR2F | \$1,487 | \$1,487 |
| 1 | Cube Bundle A | HLSL15-SOO | \$326 | \$326 |
| 2 | Drawer Cube 15"W x 13"D x 4"H | HLSL154LSD | \$243 | \$486 |
| 1 | Voi® Shelf 30"W x 13"D | HLSLR1330 | \$210 | \$210 |
| 1 | Angled Steel Leg 29"H | HLSL28AM2 | \$356 | \$356 |
| 1 | 4"H Steel Stanchion | HLSL4AM2 | \$167 | \$167 |
| 1 | Rectangle Worksurface 72"W x 30"D | HLSLR3072 | \$527 | \$527 |
| 1 | Mixed Material Floating Modesty Panel 42"W x 14"H | HLSL4214MM | \$906 | \$906 |
| TOTAL: | | | \$4,465 | |

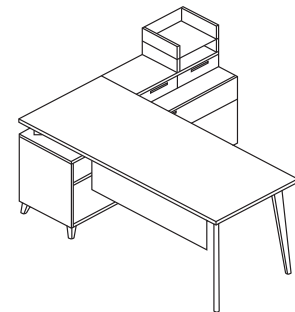
**SMALL FOOTPRINT****60" W x 72" D**



Icon Legend on page 19

VOI® Laminate Typicals

DESKS

| QTY | DESCRIPTION | MODEL | LIST PRICE | PRICE EXTENSION |
|---------------|---|------------|----------------|-----------------|
| 1 | Mixed Material Floating Modesty Panel 42"W x 14"H | HLSL4214MM | \$906 | \$906 |
| 1 | Rectangular Worksurface 48"W x 24"D | HLSLR2448 | \$337 | \$337 |
| 2 | Drawer Cube 15"W x 13"D x 4"H | HLSL154LSD | \$243 | \$486 |
| 1 | Cube Bundle A | HLSL15-SOO | \$326 | \$326 |
| 2 | Angled Steel Leg 29"H | HLSL28AM2 | \$356 | \$712 |
| 1 | Rectangle Worksurface 60"W x 30"D | HLSLR3060 | \$451 | \$451 |
| 1 | Voi® Shelf 30"W x 13"D | HLSLR1330 | \$210 | \$210 |
| 1 | Support Pedestal 24"W x 28"D | HLSL2428B | \$855 | \$855 |
| TOTAL: | | | \$4,283 | |

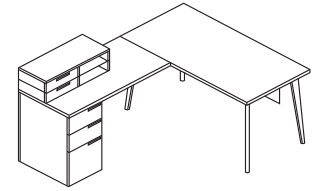

SMALL FOOTPRINT
78"W x 60"D

| QTY | DESCRIPTION | MODEL | LIST PRICE | PRICE EXTENSION |
|---------------|---|-------------|----------------|-----------------|
| 1 | Box/File Pedestal, Footed 16"W x 20"D x 28½"H | HLSL2016FP2 | \$952 | \$952 |
| 2 | Drawer Cube 15"W x 13"D x 4"H | HLSL154LSD | \$243 | \$486 |
| 1 | Cube Bundle A | HLSL15-SOO | \$326 | \$326 |
| 1 | Short Open Cube 15"W x 13"D x 4"H | HLSL154LSO | \$163 | \$163 |
| 1 | Voi® Shelf 30"W x 13"D | HLSLR1330 | \$210 | \$210 |
| 2 | Voi® Shelf 45"W x 13"D | HLSLR1345 | \$256 | \$512 |
| 1 | 4"H Steel Stanchion | HLSL4AM2 | \$167 | \$167 |
| 1 | Rectangle Worksurface 72"W x 30"D | HLSLR3072 | \$527 | \$527 |
| 1 | Rectangular Worksurface 48"W x 24"D | HLSLR2448 | \$337 | \$337 |
| 1 | Shelf Brackets | HLSLSB | \$106 | \$106 |
| 1 | Mixed Material Floating Modesty Panel 54"W x 14"H | HLSL5414MM | \$1,089 | \$1,089 |
| 2 | Angled Wood Leg 29"H | HLSL28AW2 | \$462 | \$924 |
| TOTAL: | | | \$5,799 | |

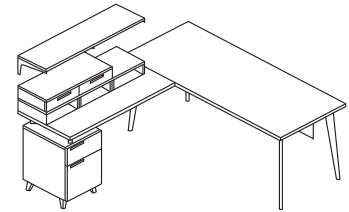

SMALL FOOTPRINT WITH SHELF
78"W x 72"D

| QTY | DESCRIPTION | MODEL | LIST PRICE | PRICE EXTENSION |
|---------------|---|--------------|----------------|-----------------|
| 1 | Low Credenza, 2 File/Open, Footed 60"W x 20"D x 24½"H | HLSL2060LD2F | \$1,617 | \$1,617 |
| 1 | Cabinet Cube, Left Handed 15"W x 13"D x 12"H | HLSL1512LSCL | \$243 | \$243 |
| 1 | Short Open Cube 15"W x 13"D x 4"H | HLSL154LSO | \$163 | \$163 |
| 2 | Drawer Cube 15"W x 13"D x 4"H | HLSL154LSD | \$243 | \$486 |
| 1 | Voi® Shelf 45"W x 13"D | HLSLR1345 | \$256 | \$256 |
| 2 | Angled Steel Leg 29"H | HLSL28AM2 | \$356 | \$712 |
| 1 | Rectangle Worksurface with Stiffener 60"W x 30"D | HLSLR3060W | \$532 | \$532 |
| 1 | Mixed Material Floating Modesty Panel 42"W x 14"H | HLSL4214MM | \$906 | \$906 |
| TOTAL: | | | \$4,915 | |

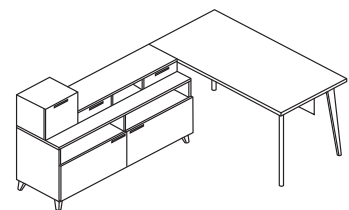

SMALL FOOTPRINT
90"W x 60"D

VOI® Laminate Typicals



Icon Legend on page 19

| QTY | DESCRIPTION | MODEL | LIST PRICE | PRICE EXTENSION |
|---------------|---|--------------|----------------|-----------------|
| 1 | Cube Bundle A | HLSL15-SOO | \$326 | \$326 |
| 2 | Angled Steel Leg 29"H | HLSL28AM2 | \$356 | \$712 |
| 1 | Rectangle Worksurface 72"W x 30"D | HLSLR3072 | \$527 | \$527 |
| 1 | Mixed Material Floating Modesty Panel 54"W x 14"H | HLSL5414MM | \$1,089 | \$1,089 |
| 1 | Low Credenza, 2 File/Open, Footed 60"W x 20"D x 24½"H | HLSL2060LD2F | \$1,617 | \$1,617 |
| 4 | Drawer Cube 15"W x 13"D x 4"H | HLSL154LSD | \$243 | \$972 |
| 2 | Voi® Shelf 30"W x 13"D | HLSLR1330 | \$210 | \$420 |
| TOTAL: | | | \$5,663 | |

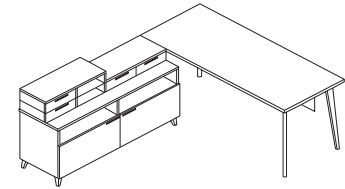

**SMALL FOOTPRINT WITH
SIX CUBES
90"W x 72"D**

| QTY | DESCRIPTION | MODEL | LIST PRICE | PRICE EXTENSION |
|---------------|---|---------------|----------------|-----------------|
| 1 | Low Credenza, 2 File/Open, Footed 60"W x 20"D x 24½"H | HLSL2060LD2F | \$1,617 | \$1,617 |
| 1 | Low Credenza, Open, Footed 30"W x 20"D x 24½"H | HLSL2030LD0F | \$1,036 | \$1,036 |
| 1 | Cube Bundle C | HLSL15-SODLOC | \$843 | \$843 |
| 2 | Voi® Shelf 45"W x 13"D | HLSLR1345 | \$256 | \$512 |
| 1 | Angled Steel Leg 29"H | HLSL28AM2 | \$356 | \$356 |
| 1 | 4"H Steel Stanchion | HLSL4AM2 | \$167 | \$167 |
| 1 | Rectangle Worksurface 72"W x 30"D | HLSLR3072 | \$527 | \$527 |
| 1 | Mixed Material Floating Modesty Panel 42"W x 14"H | HLSL4214MM | \$906 | \$906 |
| TOTAL: | | | \$5,964 | |

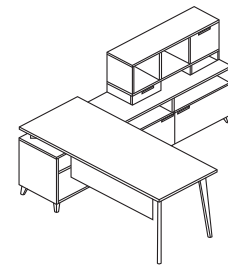

**MEDIUM FOOTPRINT WITH
CUBE BUNDLE C
90"W x 72"D**

| QTY | DESCRIPTION | MODEL | LIST PRICE | PRICE EXTENSION |
|---------------|---|-------------|----------------|-----------------|
| 1 | External Channel 48"W | HLSLZ5SC60 | \$106 | \$106 |
| 1 | Rectangle Worksurface 30"D x 72"W | HLSLR3072 | \$527 | \$527 |
| 1 | Rectangle Worksurface 20"D x 72"W | HLSLR2072 | \$439 | \$439 |
| 1 | Low Credenza (2 file drawers) 60"W x 20"D x 21½"H | HLSL2060LD2 | \$1,543 | \$1,543 |
| 1 | Overhead Cabinet - Metal Frame, Glass Doors 72"W x 14¼"D x 14"H | HLSL1472M | \$2,412 | \$2,412 |
| 1 | O-Leg Stack-on Storage Support (2 pack) 65"H | HLSL65OS | \$526 | \$526 |
| 1 | O-Leg Support for Worksurface (1 pack) 20"D x 28½"H | HLSL2028O | \$328 | \$328 |
| 2 | O-Leg Support for Worksurface (1 pack) 30"D x 28½"H | HLSL3028O | \$395 | \$790 |
| 1 | Box/Box/File Pedestal Support 20"D x 28½"H | HLSL2028B | \$773 | \$773 |
| 1 | Mixed Material Floating Modesty Panel 60"W x 14"H | HLSL6014MM | \$1,243 | \$1,243 |
| 1 | Storage Cube 12" x 12" | HLSL1212 | \$316 | \$316 |
| TOTAL: | | | \$9,003 | |

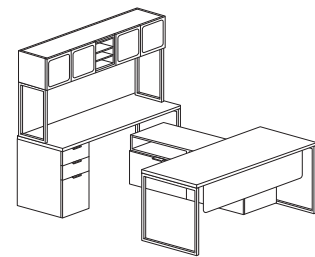

**PRIVATE OFFICE
92" x 72"**



Icon Legend on page 19

VOI® Laminate Typicals

DESKS

| QTY | DESCRIPTION | MODEL | LIST PRICE | PRICE EXTENSION |
|---------------|---|------------|----------------|-----------------|
| 1 | Box/Box/File Pedestal Support 30"D x 28"H | HLSL3028B | \$962 | \$962 |
| 1 | Rectangle Worksurface 36"D x 72"W | HLSLR3672 | \$684 | \$684 |
| 1 | End Panel Support 24"D x 28½"H | HLSL2428E | \$228 | \$228 |
| 1 | End Panel Support 30"D x 28½"H | HLSL3028E | \$243 | \$243 |
| 1 | Rectangle Worksurface 20"D x 42"W | HLSLR2042 | \$295 | \$295 |
| 1 | Rectangle Worksurface 24"D x 72"W | HLSLR2472 | \$443 | \$443 |
| 1 | Mixed Material Floating Modesty Panel 42"W x 14"H | HLSL4214MM | \$906 | \$906 |
| 1 | Lateral File 31⅝"W x 24"D x 28½"H | HLSL2430L | \$1,325 | \$1,325 |
| 1 | Overhead Cabinet - Metal Frame, Glass Doors 72"W x 14¼"D x 14"H | HLSL1472M | \$2,562 | \$2,562 |
| 1 | Storage Cube 12" x 12" | HLSL1212 | \$316 | \$316 |
| TOTAL: | | | \$7,964 | |

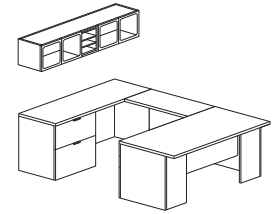

PRIVATE OFFICE
102" x 72"

| QTY | DESCRIPTION | MODEL | LIST PRICE | PRICE EXTENSION |
|---------------|---|---------------|----------------|-----------------|
| 1 | Low Credenza, 2 File/Open, Footed 60"W x 20"D x 24½"H | HLSL2060LD2F | \$1,617 | \$1,617 |
| 1 | Low Credenza, 1 File/Open, Footed 30"W x 20"D x 24½"H | HLSL2030LD1F | \$1,144 | \$1,144 |
| 1 | Left Hand Door, Footed 18"W x 20"D x 4"H | HLSLW084LF | \$1,434 | \$1,434 |
| 2 | Drawer Cube 15"W x 13"D x 4"H | HLSL154LSD | \$243 | \$486 |
| 2 | Cube Bundle A | HLSL15-SOO | \$326 | \$652 |
| 1 | Cube Bundle D | HLSL15-SDDLCC | \$972 | \$972 |
| 2 | Voi® Shelf 45"W x 13"D | HLSLR1345 | \$256 | \$512 |
| 2 | Voi® Shelf 30"W x 13"D | HLSLR1330 | \$210 | \$420 |
| 2 | Angled Wood Leg 29"H | HLSL28AW2 | \$462 | \$924 |
| 1 | Rectangle Top, Knife Edge 72"W x 30"D | HLSLR3072J | \$720 | \$720 |
| 1 | Mixed Material Floating Modesty Panel 54"W x 14"H | HLSL5414MM | \$1,089 | \$1,089 |
| TOTAL: | | | \$9,970 | |

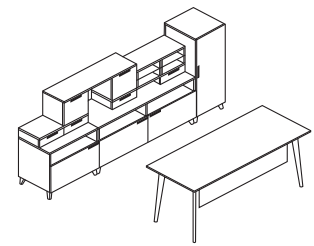

**PRIVATE OFFICE WITH
TABLE DESK**
108"W x 50"D

| QTY | DESCRIPTION | MODEL | LIST PRICE | PRICE EXTENSION |
|---------------|--|-------------|----------------|-----------------|
| 1 | Tower (Right hand drawers/Left hand door) 24"W x 20"D x 65"H, Left | HLSLW046L | \$2,449 | \$2,449 |
| 1 | Layering Shelf 60"W x 14½"D x 5½"H | HLSL1460LS | \$410 | \$410 |
| 1 | Rectangle Worksurface 30"D x 72"W | HLSLR3072 | \$527 | \$527 |
| 1 | Mixed Material Floating Modesty Panel 42"W x 14"H | HLSL4214MM | \$906 | \$906 |
| 2 | O-Leg Support for Worksurface (1 pack) 30"D x 28½"H | HLSL3028O | \$395 | \$790 |
| 1 | Low Credenza (2 file/2 box) 60"W x 20"D x 21½"H | HLSL2060LD4 | \$1,647 | \$1,647 |
| 1 | Low Credenza (Open/Right hand drawers) 60"W x 20"D x 21½"H | HLSL2060LR2 | \$1,412 | \$1,412 |
| 1 | Credenza Cushion 20"W x 30"D x 1"H | HLSL2030CH2 | \$418 | \$418 |
| TOTAL: | | | \$8,559 | |

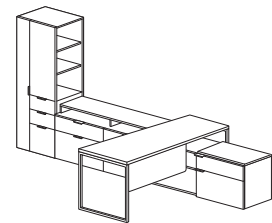

PRIVATE OFFICE
144" x 72"

VOI® Laminate Typicals



Icon Legend on page 19

| QTY | DESCRIPTION | MODEL | LIST PRICE | PRICE EXTENSION |
|---------------|--|------------|-----------------|-----------------|
| 1 | Personal Storage Tower (Left handed) 24"W x 24"D x 65"H | HLSLW446LP | \$2,920 | \$2,920 |
| 2 | Lateral File 31 ³ / ₈ "W x 24"D x 28 ¹ / ₂ "H | HLSL2430L | \$1,325 | \$2,650 |
| 1 | Rectangle Worksurface 24"D x 60"W | HLSLR2460 | \$394 | \$394 |
| 1 | Rectangle Worksurface 30"D x 72"W | HLSLR3072 | \$527 | \$527 |
| 1 | Rectangle Worksurface 24"D x 54"W | HLSLR2454 | \$363 | \$363 |
| 2 | O-Leg Support for Worksurface (1 pack) 30"D x 28 ¹ / ₂ "H | HLSL30280 | \$395 | \$790 |
| 2 | Overhead Cabinet with Wall Bracket with One Sliding Door 72"W x 14 ¹ / ₄ "D x 13"H | HLSL1472S | \$1,717 | \$3,434 |
| 2 | Storage Cube 12" x 12" | HLSL1212 | \$316 | \$632 |
| 1 | External Channel 60"W | HLSLZ55C72 | \$119 | \$119 |
| TOTAL: | | | \$11,829 | |

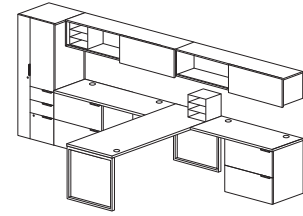

OPEN PLAN
168" x 72"

| QTY | DESCRIPTION | MODEL | LIST PRICE | PRICE EXTENSION |
|---------------|---|-------------|-----------------|-----------------|
| 4 | External Channel 48"W | HLSLZ55C60 | \$106 | \$424 |
| 2 | Accelerate® Raceway Panels 42 ¹ / ₂ "H x 60"W | HETP4260FP | \$476 | \$952 |
| 2 | Accelerate® Raceway Panels 50"H x 60"W | HETP5060FP | \$530 | \$1,060 |
| 2 | Electrical Power Harness, 3-1 & 2-2 60"W | HH871260 | \$239 | \$478 |
| 4 | Duplex Receptacle Circuit 3, 3-1 | HH871503 | \$47 | \$188 |
| 1 | Power In-Feed | HH879072 | \$253 | \$253 |
| 2 | Low Credenza (Right hand drawers) 60"W x 20"D x 21 ¹ / ₂ "H | HLSL2060LR2 | \$1,412 | \$2,824 |
| 2 | Low Credenza (Left hand drawers) 60"W x 20"D x 21 ¹ / ₂ "H | HLSL2060LL2 | \$1,412 | \$2,824 |
| 4 | Credenza Cushion 20"W x 30"D x 1"H | HLSL2030CH2 | \$418 | \$1,672 |
| 4 | O-Leg Support for Worksurface (1 pack) 30"D x 28 ¹ / ₂ "H | HLSL24280 | \$357 | \$1,428 |
| 2 | Left O-Leg to Panel Bracket | HLSLPBL | \$111 | \$222 |
| 2 | Right O-Leg to Panel Bracket | HLSLPBR | \$111 | \$222 |
| 4 | Accelerate® Top Cap 60"W | HETC60 | \$94 | \$376 |
| 2 | Accelerate® Variable Height Finishing Kit | HECVH07P | \$60 | \$120 |
| 2 | Accelerate® Finished End Cover 50"H | HEFEC50P | \$65 | \$130 |
| 2 | Accelerate® Finished End Cover 42¹/₂"H | HEFEC42P | \$61 | \$122 |
| 1 | Accelerate® "X" Connector 50"H | HEC50PXN | \$133 | \$133 |
| 4 | O-Leg Support for Worksurface 24"D x 7"H | HLSL2470 | \$240 | \$960 |
| 4 | Rectangle Worksurface 24"D x 60"W | HLSLR2460 | \$394 | \$1,576 |
| TOTAL: | | | \$15,964 | |

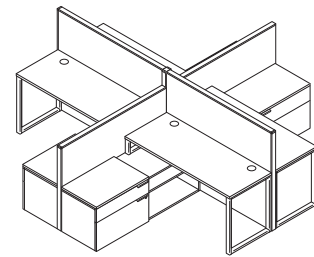

OPEN PLAN
120" x 120"



Icon Legend on page 19

VOI®

Laminate Typicals

DESKS

| QTY | DESCRIPTION | MODEL | LIST PRICE | PRICE EXTENSION |
|---------------|---|-------------|------------|-----------------|
| 4 | External Channel 60"W | HLSLZ5SC72 | \$119 | \$476 |
| 4 | Rectangle Worksurface 24"D x 72"W | HLSLR2472 | \$443 | \$1,772 |
| 2 | O-Leg Shared Support for Low Credenzas | HLSL247SL | \$299 | \$598 |
| 2 | Double Depth O-Leg Support for Worksurface 48"D x 28½"H | HLSL48280 | \$670 | \$1,340 |
| 2 | Low Credenza (Right hand drawers) 60"W x 20"D x 21½"H | HLSL2060LR2 | \$1,412 | \$2,824 |
| 2 | Low Credenza (Left hand drawers) 60"W x 20"D x 21½"H | HLSL2060LL2 | \$1,412 | \$2,824 |
| 2 | Above/Below Privacy Screen 60"W x 28½"H | HLSL2860 | \$1,565 | \$3,130 |
| TOTAL: | | | | \$12,964 |

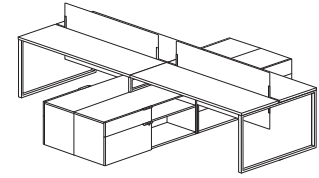

OPEN PLAN
144" x 120"

| QTY | DESCRIPTION | MODEL | LIST PRICE | PRICE EXTENSION |
|---------------|--|--------------|------------|-----------------|
| 1 | Low Credenza, Right Hand Drawers, Footed 60"W x 20"D x 24½"H | HLSL2060LR2F | \$1,487 | \$1,487 |
| 1 | Low Credenza, Left Hand Drawers, Footed 60"W x 20"D x 24½"H | HLSL2060LL2F | \$1,487 | \$1,487 |
| 1 | Cube Bundle A | HLSL15-SOO | \$326 | \$326 |
| 2 | Drawer Cube 15"W x 13"D x 4"H | HLSL154LSD | \$243 | \$486 |
| 1 | Cabinet Cube, Right Handed 15"W x 13"D x 12"H | HLSL1512LSCR | \$243 | \$243 |
| 1 | Cabinet Cube, Left Handed 15"W x 13"D x 12"H | HLSL1512LSCL | \$243 | \$243 |
| 3 | Voi® Shelf 30"W x 13"D | HLSLR1330 | \$210 | \$630 |
| 4 | Angled Steel Leg 29"H | HLSL28AM2 | \$356 | \$1,424 |
| 2 | Rectangle Top, Knife Edge 60"W x 30"D | HLSLR3060J | \$616 | \$1,232 |
| TOTAL: | | | | \$7,558 |

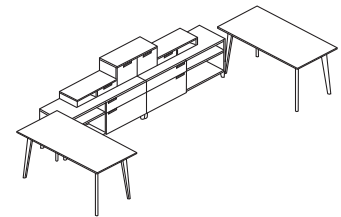

LARGE FOOTPRINT
TEAMING
180" W x 80" D

VOI® Bundles Typicals



Icon Legend on page 19

VT6030MB

Worksurface is Silver Mesh, Mobile Pedestal is Harvest, O-Leg Supports and grommets are Platinum Metallic.

| QTY | DESCRIPTION | MODEL | LIST PRICE | PRICE EXTENSION |
|---------------|---|-------------|----------------|-----------------|
| 1 | Rectangle Worksurface with External Support Channel | HLSLR3060W* | \$532 | \$532 |
| 2 | O-Leg Support for Worksurface | HLSL3028O | \$399 | \$798 |
| 1 | Mobile Pedestal | HLSL2016MP2 | \$893 | \$893 |
| TOTAL: | | | \$2,223 | |

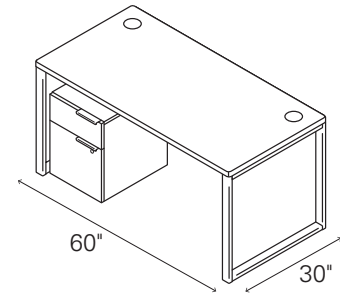
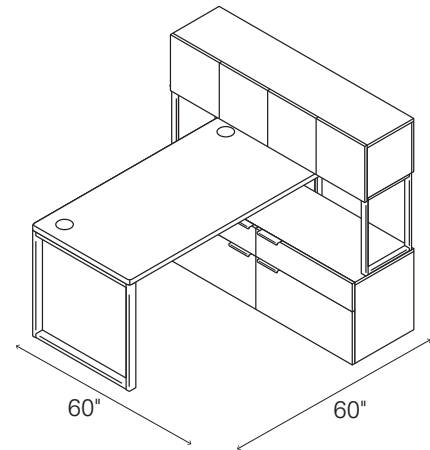

**TABLE DESK WITH MOBILE PEDESTAL
(NON-HANDED)**

VS6060L1B

Worksurface is Silver Mesh, Low Credenza and Overhead Cabinet are Harvest, O-Leg Supports and grommets are Platinum Metallic.

| QTY | DESCRIPTION | MODEL | LIST PRICE | PRICE EXTENSION |
|---------------|---|-------------|----------------|-----------------|
| 1 | Rectangle Worksurface with External Support Channel | HLSLR3060W* | \$532 | \$532 |
| 2 | O-Leg Support for Worksurface | HLSL3028O | \$399 | \$798 |
| 1 | Low Credenza, 2 File/2 Box | HLSL2060LD4 | \$1,647 | \$1,647 |
| 1 | Overhead Cabinet with 4 Doors | HLSL1460D | \$1,301 | \$1,301 |
| 1 | O-Leg Support for Overhead Cabinet (Pair) | HLSL650S | \$530 | \$530 |
| TOTAL: | | | \$4,808 | |



**SMALL FOOTPRINT L-STATION
(NON-HANDED)**

VS6060L6B

Worksurface is Silver Mesh, Low Credenza and Layering Shelf are Harvest, O-Leg Supports and grommets are Platinum Metallic.

| QTY | DESCRIPTION | MODEL | LIST PRICE | PRICE EXTENSION |
|---------------|---|-------------|----------------|-----------------|
| 1 | Rectangle Worksurface with External Support Channel | HLSLR3060W* | \$532 | \$532 |
| 2 | O-Leg Support for Worksurface | HLSL3028O | \$399 | \$798 |
| 1 | Low Credenza, Right-hand Drawers | HLSL2060LR2 | \$1,412 | \$1,412 |
| 1 | Layering Shelf | HLSL1460LS | \$410 | \$410 |
| TOTAL: | | | \$3,152 | |

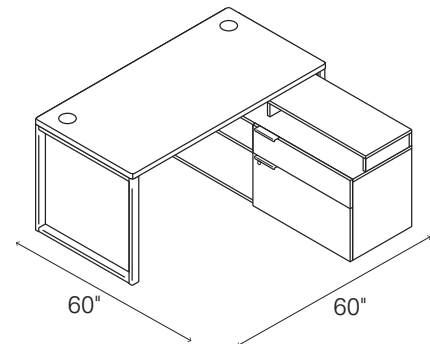

**SMALL FOOTPRINT L-STATION
(RIGHT HANDED, LOW CREDENZA)**

*Worksurface model **HLSLR3060W** can only be ordered with bundles.



Icon Legend on page 19

VOI® Bundles Typicals

VS6060L4B

Worksurface is Silver Mesh, Low Credenza and Layering Shelf are Harvest, O-Leg Supports and grommets are Platinum Metallic.

| QTY | DESCRIPTION | MODEL | LIST PRICE | PRICE EXTENSION |
|---------------|---|-------------|----------------|-----------------|
| 1 | Rectangle Worksurface with External Support Channel | HLSLR3060W* | \$532 | \$532 |
| 2 | O-Leg Support for Worksurface | HLSL30280 | \$399 | \$798 |
| 1 | Low Credenza, Left-hand Drawers | HLSL2060LL2 | \$1,412 | \$1,412 |
| 1 | Layering Shelf | HLSL1460LS | \$410 | \$410 |
| TOTAL: | | | \$3,152 | |

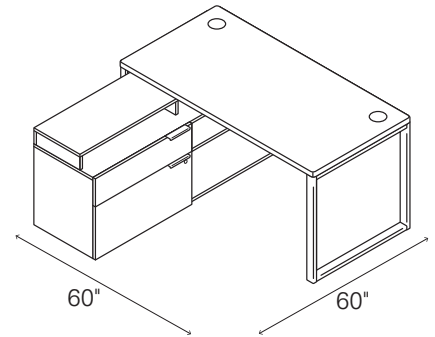

**SMALL FOOTPRINT L-STATION
(LEFT HANDED, LOW CREDENZA)**

VS6060L5B

Worksurface is Silver Mesh, Low Credenza and Overhead Cabinet are Harvest, O-Leg Supports and grommets are Platinum Metallic.

| QTY | DESCRIPTION | MODEL | LIST PRICE | PRICE EXTENSION |
|---------------|---|-------------|----------------|-----------------|
| 1 | Rectangle Worksurface with External Support Channel | HLSLR3060W* | \$532 | \$532 |
| 2 | O-Leg Support for Worksurface | HLSL30280 | \$399 | \$798 |
| 1 | Low Credenza, Right-hand Drawers | HLSL2060LR2 | \$1,412 | \$1,412 |
| 1 | Overhead Cabinet with 4 Doors | HLSL1460D | \$1,301 | \$1,301 |
| 1 | O-Leg Support for Overhead Cabinet (Pair) | HLSL650S | \$530 | \$530 |
| TOTAL: | | | \$4,573 | |

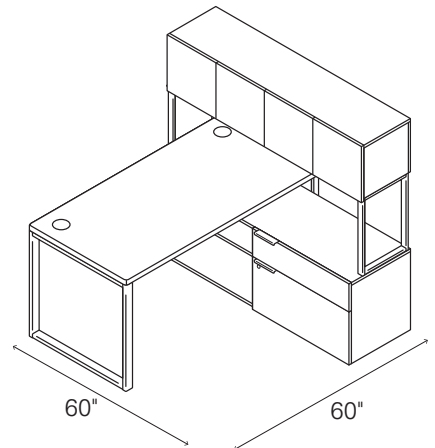

**SMALL FOOTPRINT L-STATION
(RIGHT HANDED, LOW CREDENZA)**

VS6060L3B

Worksurface is Silver Mesh, Low Credenza and Overhead Cabinet are Harvest, O-Leg Supports and grommets are Platinum Metallic.

| QTY | DESCRIPTION | MODEL | LIST PRICE | PRICE EXTENSION |
|---------------|---|-------------|----------------|-----------------|
| 1 | Rectangle Worksurface with External Support Channel | HLSLR3060W* | \$532 | \$532 |
| 2 | O-Leg Support for Worksurface | HLSL30280 | \$399 | \$798 |
| 1 | Low Credenza, Left-hand Drawers | HLSL2060LL2 | \$1,412 | \$1,412 |
| 1 | Overhead Cabinet with 4 Doors | HLSL1460D | \$1,301 | \$1,301 |
| 1 | O-Leg Support for Overhead Cabinet (Pair) | HLSL650S | \$530 | \$530 |
| TOTAL: | | | \$4,573 | |

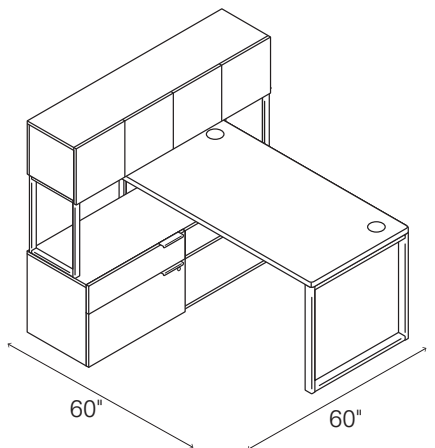

**SMALL FOOTPRINT L-STATION
(LEFT HANDED, LOW CREDENZA)**

*Worksurface model HLSLR3060W can only be ordered with bundles.

VOI® Bundles Typicals



Icon Legend on page 19

VS6060L2B

Worksurface is Silver Mesh, Low Credenza and Layering Shelf are Harvest, O-Leg Supports and grommets are Platinum Metallic.

| QTY | DESCRIPTION | MODEL | LIST PRICE | PRICE EXTENSION |
|---------------|---|-------------|----------------|-----------------|
| 1 | Rectangle Worksurface with External Support Channel | HLSLR3060W* | \$532 | \$532 |
| 2 | O-Leg Support for Worksurface | HLSL30280 | \$399 | \$798 |
| 1 | Low Credenza, 2 File/2 Box | HLSL2060LD4 | \$1,647 | \$1,647 |
| 1 | Layering Shelf | HLSL1460LS | \$410 | \$410 |
| TOTAL: | | | \$3,387 | |

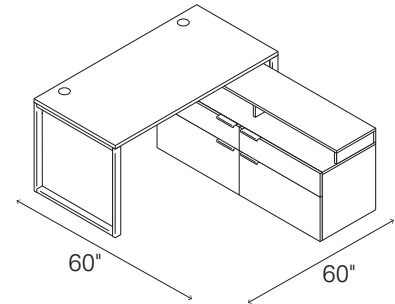

**SMALL FOOTPRINT L-STATION
(LOW CREDENZA, LAYERING SHELF)
(NON-HANDED)**

VC7260L2B

Worksurface is Silver Mesh, Low Credenza is Harvest, O-Leg Supports and grommets are Platinum Metallic.

| QTY | DESCRIPTION | MODEL | LIST PRICE | PRICE EXTENSION |
|---------------|---|-------------|----------------|-----------------|
| 1 | Rectangle Worksurface with External Support Channel | HLSLR3072W* | \$617 | \$617 |
| 2 | O-Leg Support for Worksurface | HLSL30280 | \$399 | \$798 |
| 1 | Low Credenza, 2 File/2 Box | HLSL2060LD4 | \$1,647 | \$1,647 |
| TOTAL: | | | \$3,062 | |

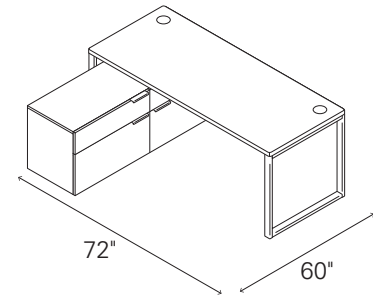

**CONTEMPORARY L-STATION
(NON-HANDED)**

*Worksurface models **HLSLR3060W** and **HLSLR3072W** can only be ordered with bundles.

This Specifying Guide is designed to walk you through the steps when choosing the Voi desks elements that will meet your particular workplace needs. From private office to open plan, there are endless combinations that will fit your style and need.

Regardless of the application, Voi presents an integrated, unified aesthetic for the entire workplace.

The step-by-step instructions make it easy to specify elements that personalize workspaces and achieve the right mix of functionality and style.

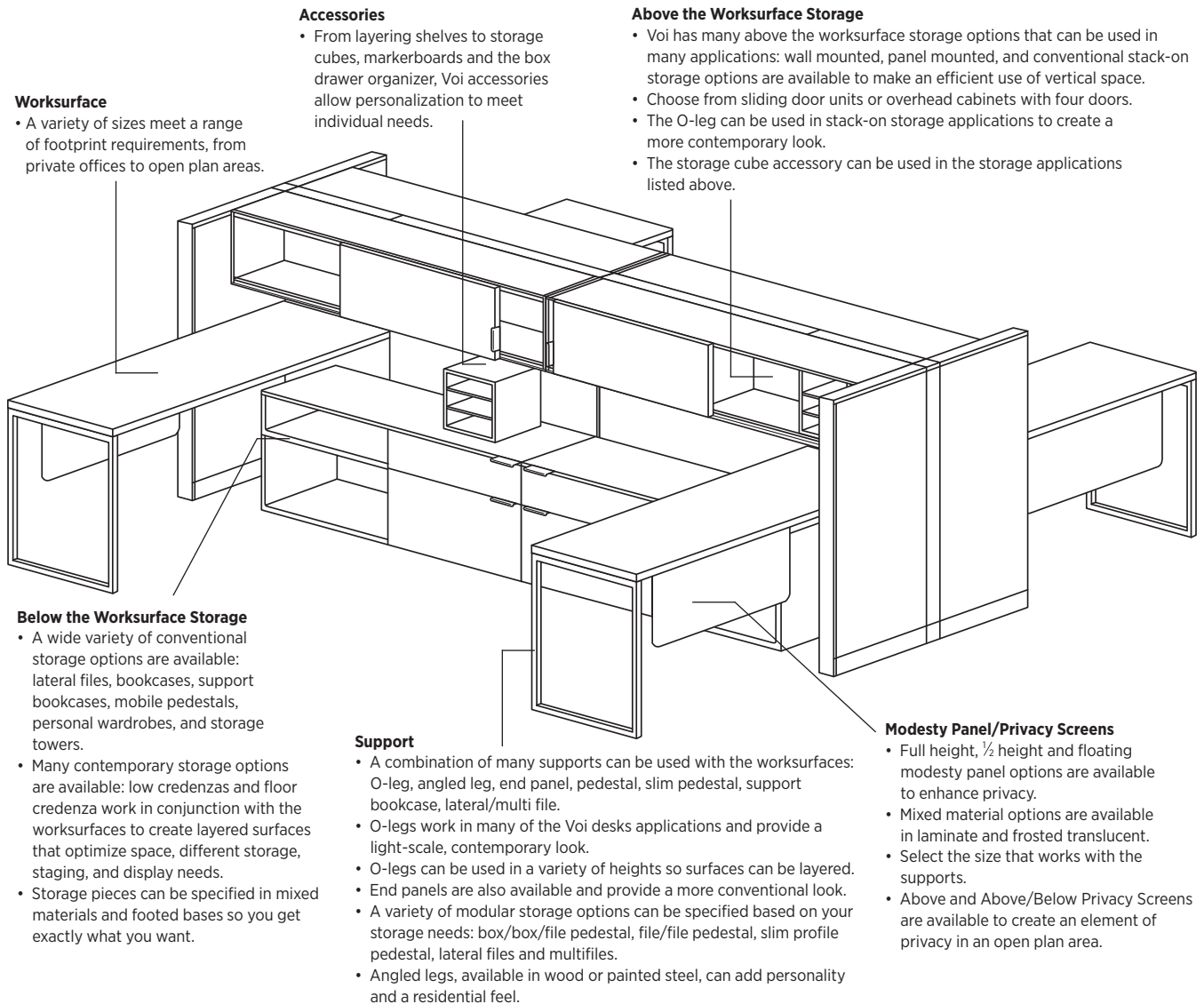

Worksurface

- A variety of sizes meet a range of footprint requirements, from private offices to open plan areas.

Accessories

- From layering shelves to storage cubes, markerboards and the box drawer organizer, Voi accessories allow personalization to meet individual needs.

Above the Worksurface Storage

- Voi has many above the worksurface storage options that can be used in many applications: wall mounted, panel mounted, and conventional stack-on storage options are available to make an efficient use of vertical space.
- Choose from sliding door units or overhead cabinets with four doors.
- The O-leg can be used in stack-on storage applications to create a more contemporary look.
- The storage cube accessory can be used in the storage applications listed above.

Below the Worksurface Storage

- A wide variety of conventional storage options are available: lateral files, bookcases, support bookcases, mobile pedestals, personal wardrobes, and storage towers.
- Many contemporary storage options are available: low credenzas and floor credenza work in conjunction with the worksurfaces to create layered surfaces that optimize space, different storage, staging, and display needs.
- Storage pieces can be specified in mixed materials and footed bases so you get exactly what you want.

Support

- A combination of many supports can be used with the worksurfaces: O-leg, angled leg, end panel, pedestal, slim pedestal, support bookcase, lateral/multi file.
- O-legs work in many of the Voi desks applications and provide a light-scale, contemporary look.
- O-legs can be used in a variety of heights so surfaces can be layered.
- End panels are also available and provide a more conventional look.
- A variety of modular storage options can be specified based on your storage needs: box/box/file pedestal, file/file pedestal, slim profile pedestal, lateral files and multifiles.
- Angled legs, available in wood or painted steel, can add personality and a residential feel.

Modesty Panel/Privacy Screens

- Full height, ½ height and floating modesty panel options are available to enhance privacy.
- Mixed material options are available in laminate and frosted translucent.
- Select the size that works with the supports.
- Above and Above/Below Privacy Screens are available to create an element of privacy in an open plan area.

VOI[®] SPECIFYING/DESIGN GUIDE

Steps for specification:

1. Select the right worksurface.

Choose the worksurface shape and size that best fits your office layout.

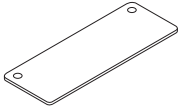

Rectangle Flat Edge Worksurface

Depths: 20", 24", 30", 36"
Widths: 36", 42", 48", 54", 60", 66", 72", 84"

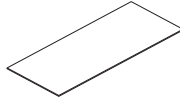

Rectangle Knife Edge Worksurface

Depths: 24", 30"
Widths: 48", 60", 72"

2. Select the supports.

Countless combinations of support options meet a variety of support and storage needs.

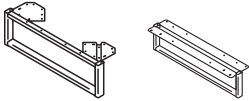

O-Leg and Shared Support for Low Credenza

20"D x 7"H, 24"D x 7"H, 30"D x 7"H
7"H only O-legs attach to worksurface and sit on top of credenzas.

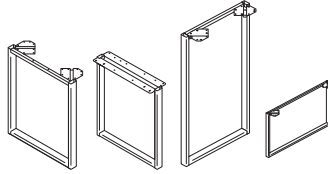

O-Leg and Shared Support for Worksurfaces

20"D x 28½"H, 24"D x 28½"H, 30"D x 28½"H
28½"H, 24"D x 41"H, 30"D x 41"H, 48"D x 28½"H,
60"D x 28½"H O-legs provide support for the worksurface.

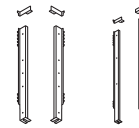

O-Leg-to-Panel Attachment Bracket

Left handed bracket (quantity 1)
Right handed bracket (quantity 1)

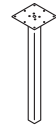

Post Leg

28½"H, 2" square

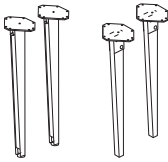

Angled Legs

12"W x 8"D x 32"H, Steel
12"W x 8"D x 32"H, Wood

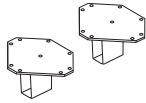

Steel Stanchions

4"H
Stanchions attach to worksurface and sit on top of credenzas.

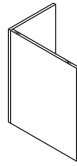

End Panel Support

16"W x 20"D x 28½"H,
16"W x 24"D x 28½"H,
16"W x 30"D x 28½"H

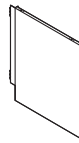

Laminate End Panel Support With Panel Attachment Bracket

24"D x 28½"H, 30"D x 28"H

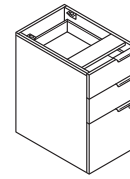

B/B/F Pedestals

16"W x 20"D x 28½"H,
16"W x 24"D x 28½"H,
16"W x 30"D x 28½"H

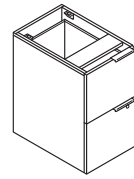

F/F Pedestals

16"W x 20"D x 28½"H,
16"W x 24"D x 28½"H,
16"W x 30"D x 28½"H

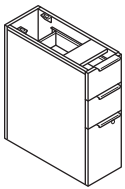

B/B/F Standard Slim Profile Pedestals

9½"W x 24"D x 28½"H,
9½"W x 30"D x 28½"H

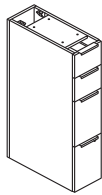

Standing-Height Pedestals

9½"W x 24"D x 41"H,
9½"W x 30"D x 41"H

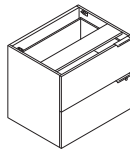

2 Drawer Lateral with Pulls

30"W x 24"D x 28½"H

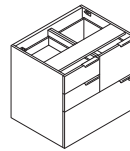

Multi-Drawer Standard File Center

30"W x 24"D x 28½"H

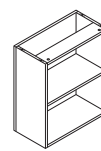

Bookcase Support

30"W x 12"D x 28½"H,
24"W x 12"D x 28½"H

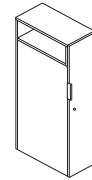

Standing-Height Towers

12"W x 30"D x 50"H,
12"W x 24"D x 50"H

Tips

- When using an O-leg in open plan, panel supported, applications, you must specify an O-leg to panel attachment bracket separately (available in 28"H and 41"H).
- Bookcase Support can only be used exterior facing.
- Telescoping ball-bearing slides used on box and file drawers. Lateral drawers use a progressive ball-bearing slide.
- When specifying a 30"D support on a 36"D worksurface, there will be a 6" overhang.
- All modular pedestals have an easy attach method to the worksurface for quick assembly.
- One double-depth O-leg can replace two regular O-legs in teaming applications.
- Shared O-legs create cleaner aesthetic where two legs are used side-by-side.
- 2" adjustable glides on O-leg supports.
- Standing-Height Support Pedestals bottom two file drawers are locking.
- Standing-Height Bookcase Support contains easy-access, fixed storage shelves.

3. Select the modesty panel/privacy screen that works in conjunction with the supports you have specified.

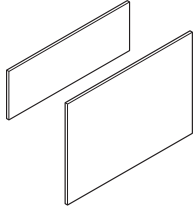

**14" H Full Width/
Half-height
Laminate Modesty
Panel**
28", 34", 40"W
(Modesty Size)
**28" H Full-to-Floor/
Full-Length
Laminate Modesty
Panel**
28", 34", 40"W
(Modesty Size)

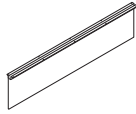

**Laminate Floating
Modesty Panel**
30"W x 14"H, 36"W x
14"H, 42"W x 14"H,
48"W x 14"H, 54"W x
14"H, 60"W x 14"H

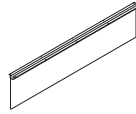

**Mixed Material
Floating Modesty
Panel**
30"W x 14"H, 36"W x
14"H, 42"W x 14"H,
48"W x 14"H, 54"W x
14"H, 60"W x 14"H
Available in Frosted
Translucent only

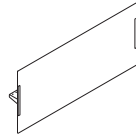

**Above/Below
Privacy Screen**
30"W x 28"H, 36"W
x 28"H, 42"W x 28"H,
48"W x 28"H, 54"W
x 28"H, 60"W x 28"H
Available in Frosted
Translucent only

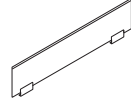

**Above Privacy
Screen**
30"W x 13"H, 36"W x
13"H, 42"W x 13"H,
48"W x 13"H, 54"W x
13"H, 60"W x 13"H
Available in Frosted
Glass only

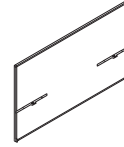

**Above/Below Fabric
Screen**
36"W x 35"H, 42"W
x 35"H, 48"W x 35"H,
54"W x 35"H, 60"W
x 35"H, 66"W x 35"H,
72"W x 35"H

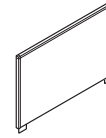

Above Fabric Screen
20"W x 20"H, 20"W
x 13"H, 24"W x 20"H,
24"W x 13"H, 30"W x
20"H, 30"W x 13"H,
36"W x 20"H, 36"W
x 13"H

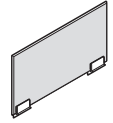

**Above Polymer or
Glass (Side) Screen**
20"W x 13"H, 24"W x
13"H, 30"W x 13"H,
36"W x 13"H

Tips

- Mixed material and laminate floating modesty panels create a lighter scale look by attaching to the top of the worksurface.
- Choose from a variety of materials to create your desired look.
- Laminate modesty panels to create a more conventional look.
- 54"W and 60"W Floating Modesty panels eliminate the need for an external channel.
- Above Privacy Screens provide a division between two worksurfaces and create a division of space in an open plan area.
- Modesty panels cannot be used as a support.
- See modesty panel chart to choose proper modesty size depending on support options.

4. Select Above the Worksurface Storage (Stack-on Storage) or Overhead Cabinets

Select the above the worksurface storage that meets your storage criteria, choose from overhead cabinets, panel mounted storage, conventional or contemporary stack-on storage.

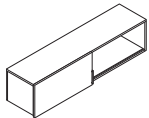

**14 1/4" D x 14" H Shared Overhead
Cabinet with One Sliding Door**
60", 72"

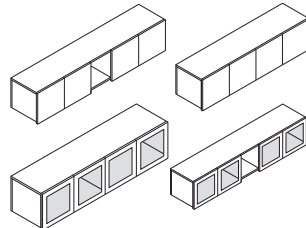

**14 1/4" Overhead Cabinet with 4 Laminate
Doors with or without Cubbie or 4 Frosted
Metal Doors with or without Cubbie**
36", 42", 48" and 60" with 4 Laminate or
Frosted Doors
60", 66" and 72" with Laminate or
Frosted Doors and Cubbie

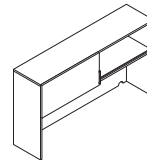

**14 1/4" D x 35" H Stack-on Storage,
Built-up, with Sliding Doors**
72" W only

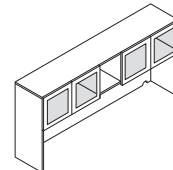

**14 1/4" D x 35" H Stack-on Storage, Built-up,
4 Frosted Metal Doors with Cubbie**
72" W only with Laminate or Frosted Doors
and Cubbie

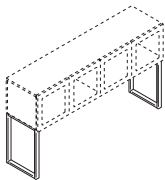

**O-Leg Support for Overhead
Cabinet**
50"-14 1/8" D x 5 1/2" H
65"-14 1/8" D x 20 1/2" H

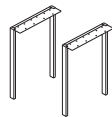

Post Legs for Shared Storage
14" H and 22" H



**Tackboard for Overhead Cabinet Applications
Tackboard for Built-up Stack-on Storage**
72" W only

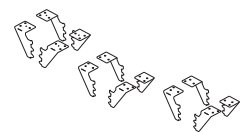

**Panel Mount Bracket for Shared
Overhead**
Abound and Accelerate

Tips

- Select sliding or hinged doors.
- Specify O-leg separately for a contemporary look.
- Optional storage shelf works in conjunction with the O-leg design to provide additional storage space. Only works with 65" H O-legs.
- O-legs come in two sizes to make a 50" H or 65" H stack-on storage unit.
- Wall mount brackets carry a \$150 upcharge and are specified in the model ordering logic.
- Use shared overhead and attachments in small footprint applications.
- Shared overhead must be ordered as left or right to determine open storage location.
- Shared overhead panel mount brackets and overhead post legs allow overhead to span over all panels systems or run down the spine wall, centered on top of the panel.
- Use the 65" H for a more conventional design. 65" H and 50" H aligns with Abound and Accelerate.
- Stack-on Storage must be placed over two full-height supports. Cannot be placed over non-supported sections such as returns using a flat bracket or tower-to-worksurface bracket.
- If the end panel conventional look is preferred, order the built-up stack-on storage models.
- There are two types of tackboards for use on Overhead Cabinet and Stack-on Storage.

VOI® SPECIFYING/DESIGN GUIDE

5. Select the right storage.

Choose from a variety of below the worksurface, as well as traditional, storage options.

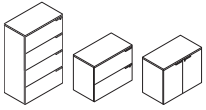

Laterals and Storage Cabinet

2-Drawer Lateral, 4-Drawer Lateral, Storage Cabinet
 36"W x 24"D x 29½"H, 36"W x 20"D x 29½"H,
 36"W x 24"D x 57"H, 36"W x 20"D x 57"H,
 36"W x 24"D x 29½"H, 36"W x 20"D x 29½"H

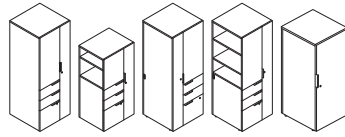

Storage Towers

18"W x 20"D, 18"W x 24"D, 24"W x 20"D, 24"W x 24"D, 50"H and 65"H
Storage Tower, One Door
 18"W x 20"D x 42"H
 Available in Footed Option

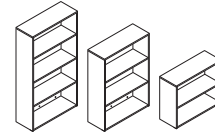

Bookshelves

36"W x 13"D x 29½"H (2 Shelf)
 36"W x 13"D x 50"H (3 Shelf)
 36"W x 13"D x 65"H (4 Shelf)

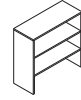

Bookcase Hutch without Doors

36"W x 14"D x 35"H

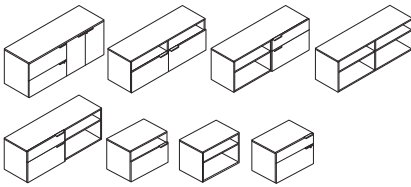

Credenzas

Credenza: 24"D x 72"W x 29½"H
 Low Credenzas: 20"D x 21½"H x 30", 36", 60", 72"W
 Low Credenzas with a variety of door/drawer options
 Limited dimensions available in Footed Option

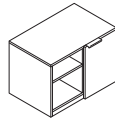

Mobile Credenza

30"W x 20"D x 21½"H

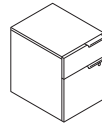

Mobile Pedestal

15¾"W x 20¼"D x 21⅞"H
 Available in Footed Option

Tips

- Small credenza models can be used in small footprint applications.
- Can use pedestal or credenza seat cushions on smaller credenza models.
- Low credenzas work in conjunction with worksurface 7" O-leg designed to create a unique layering design.
- Bookcase/laterals and other conventional storage components provide additional storage space.
- Must specify chassis and drawer front color separately.
- Low Credenzas, Laterals and Mobile Pedestals have seat cushions to create additional seating in the workspace.
- Storage and Personal Tower models offer conventional storage as well as wardrobes with a coat rod.
- A worksurface-to-tower bracket kit allows the attachment of worksurfaces to Storage and Personal Tower models.
- Telescoping ball-bearing slides used on box and file drawers. Lateral drawers use a progressive ball-bearing slide.

6. Select Accessories to add color, additional storage and organization to your workspace.

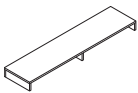

Layering Shelf

60"W x 14¼"D x 5½"H
 72"W x 14¼"D x 5½"H

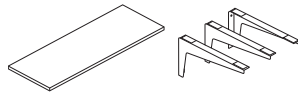

Shelves and Shelf Brackets

Shelf Depth: 13"
 Shelf Widths: 30", 36", 45"
 Bracket sold separately, set of three

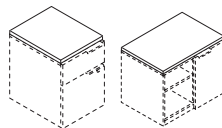

Seat Cushion for Credenzas and Mobile Credenza/Pedestal

Pedestal Cushion
 15⅞"W x 20"D x 2"H
Credenza Cushion
 20"W x 30"D x 2"H, 20"W x 36"D x 2"H

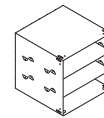

Metal Storage Cube

12" x 12"

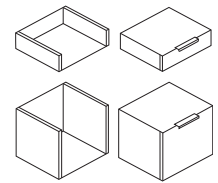

Laminate Storage Cubes

15"W x 13"D x 4"H
 15"W x 13"D x 12"H

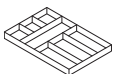

Drawer Organizer

12"W x 14½"D x 1½"H

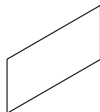

Markerboard for Shared Overhead

30"W x 15"D for use with 60"W Shared Overhead
 36"W x 15"D for use with 72"W Shared Overhead

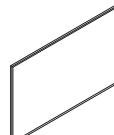

Markerboard

48"W x 31"H

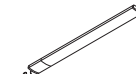

LED Task Light

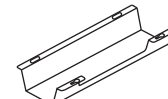

Cable Management Trough

17"W

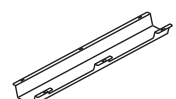

Cable Management Trough

36"W

Tips

- Choose from many bright Storage Cube colors for a colorful design element while providing additional storage.
- Use the Drawer Organizer to keep small items in order. Also offered in the same bright Storage Cube colors.
- Layering shelves are great for filing and piling or in conjunction with the lower credenza.
- Optimize shared overhead capabilities by adding the Markerboard for Shared Overhead.

VOI® AND SYSTEMS INTEGRATION

Worksurface Applications

Either Voi or Systems worksurfaces can be used with Voi in an open plan application. There are several support options:

- A. Completely panel supported.
- B. Combination of panel supported and another worksurface support such as:
 - Bookcase support
 - Pedestal (Brigade®, Flagship®, Contain®, or Voi®)
 - Systems open leg
 - Voi O-leg
 - End panel (Systems or Voi)
 - Tower to worksurface bracket
 - Support column
 - Systems round post leg
 - Voi post leg
- C. Freestanding:
 - Bookcase support
 - Two pedestals (Brigade®, Flagship®, Contain®, or Voi®)
 - Two Voi O-legs
 - One Voi O-leg and one Voi O-leg support for lower credenzas
 - Two end panels (metal or Voi)—requires metal or Voi modesty panel
 - Four (Two 2-Pack) Voi angled legs, wood or steel
 - Two Voi angled legs, steel and two Voi steel stanchion supports for low credenzas

Additional application guidelines for worksurfaces:

- Systems worksurfaces are available with grommets or no grommets.
- When Voi lower credenzas are used along the spine wall and are placed adjacent to the wing wall, one electrical/data cutout on the wing wall will be blocked.
- When Voi credenzas are used along the wing wall and are placed adjacent to the spine wall, one electrical/data cutout on the spine wall will be blocked.
- When the Voi O-leg support for credenzas is used, it is recommended to also panel attach the worksurface with the worksurface anti-dislodgement bracket kit HWSA2.
- When the Voi O-leg support is used with panels, it is recommended to also panel attach the O-leg to the panel with the O-leg to panel bracket kit HLSPPB (left) and/or HLSPPR (right). This bracket will provide additional workstation rigidity.
- When the Voi end panel support is used with panels, it is recommended to use the end panel support with panel bracket model. This model will provide additional workstation rigidity.
- The worksurface to tower bracket kit, HSTB2W1, will work with Voi towers, Voi worksurfaces, and systems worksurfaces.
- Knife Edge surfaces are recommended to only use angled post legs as supports.
- Knife Edge worksurfaces are intended to be stand-alone. Surface gaps may occur if connecting to a panel or using return worksurfaces.

Application Guidelines—Combination of Panel Supported and Another Worksurface Support

- For applications where 1) the worksurface is perpendicular to the spine wall; 2) the worksurface is panel supported off the spine wall; and 3) there are Voi credenzas placed under the worksurface along the spine: there is not enough clearance to use standard worksurface cantilevers to attach the worksurface to the spine. Use the worksurface anti-dislodgement bracket kit HWSA2 to panel attach the worksurface in lieu of cantilevers.

Panel Mounted Stack-on Storage Applications

- The Voi stack-on storage cabinets can be used on Abound and Accelerate as panel mounted overheads.
- The sliding door stack-on storage units are available in 36", 42", 48" widths in addition to 60", 66", and 72" widths.
- The 4 door stack-on storage units are only available in 36", 42", 48", 60", 66", and 72" widths.
- The storage units require a storage to panel bracket kit, model HLSPMB. This model includes one left hand, one right hand, and one center bracket. The brackets are available in all P1 and P2 paint colors.
- The storage cabinets do not have off modular capabilities.
- For proper installation and support, the storage units must follow the following specification rules:
 - There should be a storage unit of the same construction on each side of a given panel.
 - The storage units on opposite sides of a given panel should be in the same location vertically and horizontally.
 - Only one storage unit per panel, per side.
 - The wing panel adjacent to the spine wall needs to be the same height as the spine wall.

Contact HON's Integrated Design Services team with specification questions.

VOI® Laminate Worksurfaces — Rectangle

GSA SIN 33721



Icon Legend on page 19

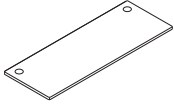

| DESCRIPTION | MODEL | SHIP WEIGHT | CUBE | LIST PRICE BY LAMINATE GRADE | |
|-------------------------------|--------------------|-------------|------|------------------------------|--------------|
| | | | | L1 | L2 |
| Rectangle Worksurfaces | | | | | |
| 36"W x 20"D | HLSLR2036 | 40 | 2.2 | \$265 | \$275 |
| 42"W x 20"D | HLSLR2042 | 46 | 2.6 | \$295 | \$305 |
| 48"W x 20"D | HLSLR2048 | 52 | 2.9 | \$318 | \$328 |
| 54"W x 20"D | HLSLR2054 | 64 | 3.5 | \$357 | \$372 |
| 60"W x 20"D | HLSLR2060 | 70 | 3.5 | \$392 | \$407 |
| 66"W x 20"D | HLSLR2066 | 76 | 4.2 | \$426 | \$441 |
| 72"W x 20"D | HLSLR2072 | 82 | 4.2 | \$439 | \$454 |
| 36"W x 24"D | HLSLR2436 | 47 | 2.6 | \$277 | \$292 |
| 42"W x 24"D | HLSLR2442 | 54 | 3.0 | \$311 | \$326 |
| 48"W x 24"D | HLSLR2448 ⓘ | 61 | 3.4 | \$337 | \$352 |
| 54"W x 24"D | HLSLR2454 | 68 | 4.2 | \$363 | \$383 |
| 60"W x 24"D | HLSLR2460 | 75 | 4.2 | \$394 | \$414 |
| 66"W x 24"D | HLSLR2466 | 82 | 5.0 | \$428 | \$448 |
| 72"W x 24"D | HLSLR2472 | 89 | 5.0 | \$443 | \$463 |
| 84"W x 24"D | HLSLR2484 | 103 | 5.7 | \$650 | \$675 |

NOTES:

- Systems worksurfaces can be used with all Voi components.
- Worksurfaces are abrasion- and stain-resistant laminate over durable 1/8" solid core high performance particleboard: resists wrapping.
- There is one 3" grommet in 36"W and 42"W worksurfaces and two in 48"W-84"W worksurfaces.
- One flat bracket ships with each worksurface.
- When attaching tops to panels, refer to Systems section of this pricer.
- Square edge detail.
- When using a floating modesty panel or an external channel under the worksurface, the depth clearance for keyboard trays and center drawers decreases by 8". See accessory matrix in accessory section of the pricer.
- 3" Power Hub model HGRMTAC can be interchanged with 3" standard grommet.
- ⓘ Voi® worksurfaces cannot be used with Abode™ Desks components.
- ⓘ Grommets in worksurfaces must be specified. If grommets are specified, grommets come in predetermined location.
- ⓘ Edgeband option only on all Voi worksurfaces. For edgeband options, see matrix on page 183.
- ⓘ When specifying an 84" Worksurface, cannot use two O-legs, must use at least one additional support such as a pedestal or lateral file.
- ⓘ When using a worksurface as a bridge, no additional supports are needed. One support is required for returns, two supports are required for desks and credenzas.
- ⓘ Lateral file or multi files must be used with surfaces 24"D and 60"W or greater.
- ⓘ Depending on your support combination, an external channel may be required for extra support on unsupported spans greater than 54"W. Please see the matrix on page 201 for more details.
- ⓘ If using a 54"W or 60"W floating modesty, it is not necessary to spec an external channel.
- ⓘ When attaching worksurfaces to panels, one or more of the following are required: anti-dislodgement brackets, end panel, support leg and/or cantilevers. Cantilevers and anti-dislodgement brackets must be ordered separately when attaching worksurfaces to panels.
- ⓘ A return worksurface is considered 48"W or shorter. Longer returns cannot be supported by a flat bracket only.

HOW TO SPECIFY

| | | |
|--|---|---|
| <p>Select Model Number</p> <p>H L S L R 2 0 3 6 .</p> | <p>Select Worksurface Laminate and Edge Color</p> <p>See page 183</p> <p>N N .</p> | <p>Select Grommet Option and Color</p> <p>X No Grommet If choosing the grommet option G Grommet Select Grommet Color See page 183</p> <p>G T 5</p> |
|--|---|---|



Laminate Worksurfaces — Rectangle

| | DESCRIPTION | MODEL | SHIP WEIGHT | CUBE | LIST PRICE BY LAMINATE GRADE | |
|-------------|-------------------------------|------------------|-------------|--------------|------------------------------|--------------|
| | | | | | L1 | L2 |
| | Rectangle Worksurfaces | | | | | |
| | 36"W x 30"D | HLSLR3036 | 58 | 3.2 | \$318 | \$333 |
| | 42"W x 30"D | HLSLR3042 | 67 | 3.7 | \$342 | \$357 |
| | 48"W x 30"D | HLSLR3048 | 75 | 4.2 | \$363 | \$378 |
| | 54"W x 30"D | HLSLR3054 | 84 | 5.1 | \$403 | \$423 |
| | 60"W x 30"D | HLSLR3060 | 92 | 5.1 | \$451 | \$471 |
| | 66"W x 30"D | HLSLR3066 | 101 | 6.1 | \$485 | \$505 |
| | 72"W x 30"D | HLSLR3072 | 110 | 6.1 | \$527 | \$547 |
| | 84"W x 30"D | HLSLR3084 | 127 | 7.0 | \$718 | \$743 |
| | 60"W x 36"D | HLSLR3660 | 110 | 6.1 | \$564 | \$589 |
| 66"W x 36"D | HLSLR3666 | 120 | 7.2 | \$610 | \$635 | |
| 72"W x 36"D | HLSLR3672 | 130 | 7.2 | \$684 | \$709 | |

NOTES:

- Systems worksurfaces can be used with all Voi components.
- Worksurfaces are abrasion- and stain-resistant laminate over durable 1/8" solid core high performance particleboard: resists wrapping.
- There is one 3" grommet in 36"W and 42"W worksurfaces and two in 48"W-84"W worksurfaces.
- One flat bracket ships with each worksurface.
- When attaching tops to panels, refer to Systems section of this pricer.
- Square edge detail.
- When using a floating modesty panel or an external channel under the worksurface, the depth clearance for keyboard trays and center drawers decreases by 8". See accessory matrix in accessory section of the pricer.
- 3" Power Hub model HGRMTAC can be interchanged with 3" standard grommet.
- ! Voi® worksurfaces cannot be used with Abode™ Desks components.
- ! Grommets in worksurfaces must be specified. If grommets are specified, grommets come in predetermined location.
- ! Edgeband option only on all Voi worksurfaces.
- ! When specifying an 84" Worksurface, cannot use two O-legs, must use at least one additional support such as a pedestal or lateral file.
- ! When using a worksurface as a bridge, no additional supports are needed. One support is required for returns, two supports are required for desks and credenzas.
- ! Lateral file or multi files must be used with surfaces 24"D and 60"W or greater.
- ! Depending on your support combination, an external channel may be required for extra support on unsupported spans greater than 54"W. Please see page 201 for models and a matrix to aid in specifying.
- ! If using a 54"W or 60"W floating modesty, it is not necessary to spec an external channel.
- ! When attaching worksurfaces to panels, one or more of the following are required: anti-dislodgement brackets, end panel, support leg and/or cantilevers. Cantilevers and anti-dislodgement brackets must be ordered separately when attaching worksurfaces to panels.
- ! A return worksurface is considered 48"W or shorter. Longer returns cannot be supported by a flat bracket only.

HOW TO SPECIFY

| | | |
|--|--|---|
| Select Model Number <div style="border: 1px solid black; padding: 2px; display: inline-block;">HLSLR3036</div> | Select Worksurface Laminate and Edge Color See page 183 <div style="border: 1px solid black; padding: 2px; display: inline-block;">NN</div> | Select Grommet Option and Color X No Grommet If choosing the grommet option G Grommet Select Grommet Color See page 183 <div style="border: 1px solid black; padding: 2px; display: inline-block;">GT5</div> |
|--|--|---|

Laminate Worksurfaces — Rectangle

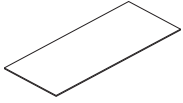

| DESCRIPTION | MODEL | SHIP WEIGHT | CUBE | LIST PRICE BY LAMINATE GRADE | |
|--|-------------------|-------------|------|------------------------------|--------------|
| | | | | L1 | L2 |
| Rectangle Worksurfaces Top with Knife Edge 48"W x 24"D 60"W x 24"D 72"W x 24"D | HLSLR2448J | 54 | 3.4 | \$462 | \$477 |
| | HLSLR2460J | 75 | 4.2 | \$538 | \$558 |
| | HLSLR2472J | 89 | 5.0 | \$605 | \$625 |
| 48"W x 30"D 60"W x 30"D 72"W x 30"D | HLSLR3048J | 75 | 4.2 | \$496 | \$511 |
| | HLSLR3060J | 92 | 5.1 | \$616 | \$636 |
| | HLSLR3072J | 110 | 6.1 | \$720 | \$740 |

NOTES:

- Systems worksurfaces can be used with all Voi® components.
- Worksurfaces are abrasion- and stain-resistant laminate over durable 1½" solid core high performance particleboard: resists wrapping.
- There are two 3" grommets in Knife Edge worksurfaces, if specified.
- When using a floating modesty panel or an external channel under the worksurface, the depth clearance for keyboard trays and center drawers decreases by 8". See accessory matrix in accessory section of the pricer.
- 3" Power Hub model HGRMTAC can be interchanged with 3" standard grommet.
- ! Voi® worksurfaces cannot be used with Abode™ Desks components.
- ! Grommets in worksurfaces must be specified. If grommets are specified, grommets come in predetermined location.
- ! Depending on your support combination, an external channel may be required for extra support on unsupported spans greater than 54"W. Please see the matrix on page 201 for more details.
- ! If using a 54"W or 60"W floating modesty, it is not necessary to spec an external channel.
- ! Voi® Knife Edge surfaces are recommended to only use angled post legs as supports.
- ! Knife Edge worksurfaces are intended to be stand-alone. Surface gaps may occur if connecting to a panel or using return worksurfaces.

HOW TO SPECIFY

| | | |
|---|--|---|
| <p>Select Model Number</p> <p>HLSLR2448J</p> | <p>Select Worksurface Laminate and Edge Color</p> <p>See page 183</p> <p>NN</p> | <p>Select Grommet Option and Color</p> <p>X No Grommet G Grommet</p> <p>If choosing the grommet option, select Grommet Color. See page 183.</p> <p>GT1</p> |
|---|--|---|

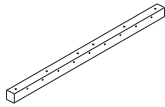

DESCRIPTION

External Support Channel
 42"W for a 54" Worksurface
 48"W for a 60" Worksurface
 54"W for a 66" Worksurface
 60"W for a 72" Worksurface
 72"W for an 84" Worksurface

MODEL

SHIP WEIGHT

CUBE

LIST PRICE

| | | | |
|---------------------|----|-----|--------------|
| HLSLZ5SC54 ☹ | 5 | 0.5 | \$101 |
| HLSLZ5SC60 ☹ | 6 | 0.5 | \$106 |
| HLSLZ5SC66 ☹ | 7 | 0.5 | \$110 |
| HLSLZ5SC72 ☹ | 7 | 0.5 | \$119 |
| HLSLZ5SC84 | 12 | 0.7 | \$119 |

- ! Available in Graphite paint only.
- ! When specifying panel-hung worksurfaces, specify external channel as if supported by two O-legs via selection chart.
- ! When specifying a 54"W or 60"W Floating Modesty Panel, it is not necessary to specify an external channel.

EXTERNAL CHANNEL SELECTION GUIDE

| Support Combination | | Worksurface Width for Rectangle, Wedge, and Saddle | | | | |
|-----------------------|-----------------------|--|------------|------------|------------|------------|
| Support 1 | Support 2 | 84 in | 72 in | 66 in | 60 in | 54 in |
| O-Leg | O-Leg | NA | HLSLZ5SC72 | HLSLZ5SC66 | HLSLZ5SC60 | HLSLZ5SC54 |
| O-Leg | Slim Profile Pedestal | HLSLZ5SC84 | HLSLZ5SC66 | HLSLZ5SC60 | HLSLZ5SC54 | NA |
| O-Leg | Bookcase | HLSLZ5SC72 | HLSLZ5SC66 | HLSLZ5SC60 | HLSLZ5SC54 | NA |
| O-Leg | Pedestal | HLSLZ5SC72 | HLSLZ5SC60 | HLSLZ5SC54 | NA | NA |
| O-Leg | End-Panel | HLSLZ5SC84 | HLSLZ5SC60 | HLSLZ5SC54 | NA | NA |
| Slim Profile Pedestal | Slim Profile Pedestal | HLSLZ5SC72 | HLSLZ5SC60 | HLSLZ5SC54 | NA | NA |
| Slim Profile Pedestal | Bookcase | HLSLZ5SC72 | HLSLZ5SC60 | HLSLZ5SC54 | NA | NA |
| Slim Profile Pedestal | Pedestal | HLSLZ5SC66 | HLSLZ5SC54 | NA | NA | NA |
| Slim Profile Pedestal | End-Panel | HLSLZ5SC66 | HLSLZ5SC54 | NA | NA | NA |
| Pedestal | Bookcase | HLSLZ5SC66 | HLSLZ5SC54 | NA | NA | NA |
| End-Panel | Bookcase | HLSLZ5SC66 | HLSLZ5SC54 | NA | NA | NA |
| Bookcase | Bookcase | HLSLZ5SC66 | HLSLZ5SC54 | NA | NA | NA |
| End-Panel | End-Panel | HLSLZ5SC60 | NA | NA | NA | NA |
| Pedestal | Pedestal | HLSLZ5SC60 | NA | NA | NA | NA |
| Pedestal | End-Panel | HLSLZ5SC60 | NA | NA | NA | NA |
| O-Leg | Lateral/Multifile | HLSLZ5SC54 | NA | NA | NA | NA |
| Bookcase | Lateral/Multifile | NA | NA | NA | NA | NA |
| Slim Profile Pedestal | Lateral/Multifile | NA | NA | NA | NA | NA |
| Pedestal | Lateral/Multifile | NA | NA | NA | NA | NA |
| End-Panel | Lateral/Multifile | NA | NA | NA | NA | NA |

*All Rudder worksurfaces use external channel model HLSLZ5SC60.

HOW TO SPECIFY

| | |
|--|---|
| <p>Select Model Number</p> <p>H L S L Z 5 S C 8 4 .</p> | <p>Select Paint Color</p> <p>See page 183</p> <p>P</p> |
|--|---|

VOI® Worksurface Supports

GSA SIN 33721

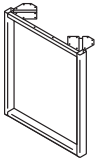
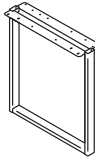
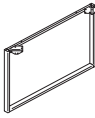
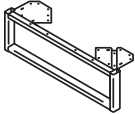
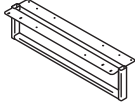

Icon Legend on page 19

| | DESCRIPTION | MODEL | SHIP WEIGHT | CUBE | LIST PRICE BY PAINT GRADE | | |
|--|---|---------------------|-------------|------|---------------------------|--------------|--------------|
| | | | | | P1 | P2 | P3 |
|  | O-Leg Support for Worksurfaces | | | | | | |
| | 20"D x 28½"H | HLSL2028O | 15 | 3.7 | \$328 | \$332 | \$348 |
| | 24"D x 28½"H | HLSL2428O | 17 | 3.7 | \$357 | \$361 | \$377 |
| | 30"D x 28½"H | HLSL3028O ⓘ | 19 | 5.4 | \$395 | \$399 | \$415 |
| | NOTES: Ship fully assembled, 1/pack. Non-handed. ⓘ Specify paint only. SPECIFYING EXAMPLE: HLSL2028O.T1 | | | | | | |
|  | O-Leg Shared Support for Worksurfaces | | | | | | |
| | 20"D x 28½"H | HLSL2028SL | 15 | 3.7 | \$392 | \$396 | \$412 |
| | 24"D x 28½"H | HLSL2428SL | 17 | 3.7 | \$443 | \$447 | \$463 |
| | 30"D x 28½"H | HLSL3028SL ⓘ | 19 | 5.4 | \$491 | \$495 | \$511 |
| | NOTES: Ship fully assembled, 1/pack. Non-handed. ⓘ Specify paint only. SPECIFYING EXAMPLE: HLSL2028SL.T1 | | | | | | |
|  | Double-Depth O-Leg Support for Worksurfaces | | | | | | |
| | 48"D x 28½"H | HLSL4828O | 18 | 7.0 | \$670 | \$678 | \$690 |
| | 60"D x 28½"H | HLSL6028O | 19 | 8.7 | \$746 | \$754 | \$766 |
| | NOTES: Ship fully assembled, 1/package. Non-handed. | | | | | | |
|  | O-Leg Support for Low Credenzas | | | | | | |
| | 20"D x 7"H | HLSL207O | 5 | 1.0 | \$222 | \$226 | \$242 |
| | 24"D x 7"H | HLSL247O | 6 | 1.0 | \$240 | \$244 | \$260 |
| | 30"D x 7"H | HLSL307O ⓘ | 7 | 1.0 | \$305 | \$309 | \$325 |
| | NOTES: Ship fully assembled, 1/pack. Non-handed. ⓘ Specify paint only. SPECIFYING EXAMPLE: HLSL207O.T1 | | | | | | |
|  | O-Leg Shared Support for Low Credenzas | | | | | | |
| | 20"D x 7"H | HLSL207SL | 5 | 1.0 | \$275 | \$279 | \$295 |
| | 24"D x 7"H | HLSL247SL | 6 | 1.0 | \$299 | \$303 | \$319 |
| | 30"D x 7"H | HLSL307SL | 7 | 1.0 | \$379 | \$383 | \$399 |
| | NOTES: Ship fully assembled, 1/pack. Non-handed. ⓘ Specify paint only. SPECIFYING EXAMPLE: HLSL207SL.T1 | | | | | | |









NOTES:

- A variety of pedestals, end panels, and O-legs can be combined to create a conventional or contemporary desk.
- O-leg ships fully assembled with mounting hardware.
- Shared O-Legs create a cleaner aesthetic in all applications where two legs are used side-by-side.
- Shared O-Leg bracket will span both worksurfaces to provide the same support with the look of a single O-leg.
- Will have a 6" overhang when using 30" worksurface supports with a 36"D worksurface.
- Glides on O-Leg Support for Worksurfaces and Post Leg Base have 2" of adjustability. No glides on 7"H O-leg. Glides on end panels have 1¼" adjustability.

ⓘ O-legs may only be attached to worksurfaces, not storage units.

HOW TO SPECIFY

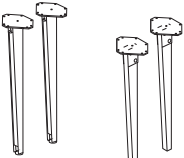
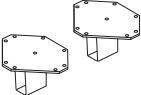
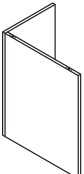
| | |
|---|--|
| Select Model Number HLSL2028O | Select Paint Color T1 <small>See page 183</small> |
|---|--|

| | DESCRIPTION | MODEL | SHIP WEIGHT | CUBE | LIST PRICE BY PAINT GRADE | | |
|--|--|--|----------------------------|-------------------|---------------------------|-------------------------|------------|
| | | | | | P1 | P2 | P3 |
|    | Post Leg Base 28½"H x 2" square ! Post leg cannot be used on primary worksurface with an O-leg as the other support. ! Post leg can only be used to support peninsula, not as primary supports for a top. | HLSL28P | 15 | 1.0 | \$321 | \$325 | \$341 |
|    | 28½"H O-Leg-to-Panel Attachment Bracket 28½"H Left handed bracket (quantity 1) 28½"H Right handed bracket (quantity 1) NOTES: Used to connect Voi O-Leg to a systems panel for additional workstation rigidity. Bracket designed to work with edgeband worksurfaces only. Brackets are handed, come one per package and include self-tapping screws. Specify paint. | HLSLPBL HLSLPBR | 3 Ⓔ 3 Ⓔ | 0.4 0.4 | \$111 \$111 | \$115 \$115 | N/A N/A |
|  HLSL28AM2 HLSL28AW2 | Angled Legs 12"W x 8"D x 32"H Steel — 2-Pack 12"W x 8"D x 32"H Wood — 2-Pack NOTES: Angled Steel Legs come equipped with a removable wire management channel in each leg. ! 4"H Stanchions to be used on floor storage with feet ONLY. ! O-Leg Support to be used on floor storage without feet ONLY. ! Wood legs use natural wood material. The color on each leg may contain natural variation. Ⓔ Pricing shown is <u>per carton</u> . Ordering 2 of either model will result in 2 cartons being shipped, giving you 4 legs. | HLSL28AM2 Ⓔ HLSL28AW2 | 15 Ⓔ 14 Ⓔ | 1.3 1.5 | \$356 \$462 | \$364 | \$376 |
|  | Steel Stanchions — 2-Pack 4"H ! 4"H Stanchions to be used on floor storage with feet ONLY. ! O-Leg Support to be used on floor storage without feet ONLY. ! Wood legs use natural wood material. The color on each leg may contain natural variation. Ⓔ Pricing shown is <u>per carton</u> . Ordering 2 of either model will result in 2 cartons being shipped, giving you 4 legs. | HLSL4AM2 | 5 Ⓔ | 0.2 | \$167 | \$175 | \$187 |
|    | End Panel Support 16"W x 20"D x 28½"H 16"W x 24"D x 28½"H 16"W x 30"D x 28½"H NOTES: Ship in two pieces. | HLSL2028E HLSL2428E HLSL3028E | 39 44 50 | 3.2 3.7 4.2 | \$212 \$228 \$243 | \$222 \$238 \$253 | |

NOTES:

- A variety of pedestals, end panels, and O-legs can be combined to create a conventional or contemporary desk.
- Voi® square support column is interchangeable with the Systems worksurface round support column: HCNLEG29.
- Glides on Post Leg Base have 2" of adjustability. Glides on end panels have 1¼" adjustability.

HOW TO SPECIFY

Select Model Number

HLSL2028E

Select Laminate/Paint

See page 183

H

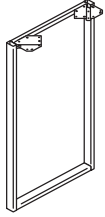
**DESCRIPTION****Standing-Height O-Leg Support for Worksurfaces**

24"D x 41"H

30"D x 41"H

MODEL**HLSL2441O****HLSL3041O****SHIP WEIGHT**

16

17

CUBE

5.3

6.5

LIST PRICE BY PAINT GRADE**P1****\$476****\$533****P2****\$482****\$539****P3****\$496****\$553**

NOTES: Ship fully assembled, 1/package. Non-handed.

Coordinate™ Power Modules will work with standing-height applications for 10500™ and Voi® desks. Please see page 122 for more information.

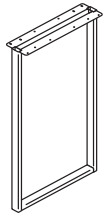
**Standing-Height O-Leg Shared Support for Worksurfaces**

24"D x 41"H

30"D x 41"H

HLSL2441SL**HLSL3041SL**

16

17

5.3

6.5

\$537**\$593****\$543****\$599****\$557****\$613**

NOTES: Ship fully assembled, 1/package. Non-handed.

Coordinate™ Power Modules will work with standing-height applications for 10500™ and Voi® desks. Please see page 122 for more information.

**Standing-Height O-Leg to Panel Attachment Bracket**

41"H Left-hand Bracket

41"H Right-hand Bracket

HLSLSPBL**HLSLSPBR**

6

6

1.0

1.0

\$140**\$140****\$144****\$144****N/A****N/A**

NOTES: 1/package. Brackets are handed as shown above. To be used with 41"H O-legs shown above (HLSL2441O and HLSL3041O).

NOTES:

- O-leg glides have 2" adjustability.
- O-Leg to Panel Attachment Brackets are used to connect Voi® O-Legs to a systems panel for additional worksurface rigidity.
- ! O-legs may only be attached to worksurfaces, not storage units.

HOW TO SPECIFY**Select Model Number**

HLSL2441O

Select Paint Color

See page 183

T1



Standing-Height Laminate Support

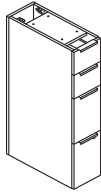

DESCRIPTION

MODEL

SHIP WEIGHT

CUBE

L1 LIST

L2 UPCHARGES
CHASSIS FRONTS

Standing-Height Support Pedestals — Box/Box/File/File

9½"W x 24"D x 41"H

HLSL2441S

94

11.9

\$1657

\$40

\$20

9½"W x 30"D x 41"H

HLSL3041S

113

14.7

\$1722

\$45

\$20

NOTES: Top two drawers are non-locking.

❗ Cannot use grommet worksurfaces with Standing-Height Support Storage.

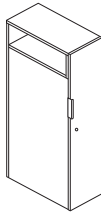

Standing-Height Side Access Storage Tower

12"W x 24"D x 50"H - Left

HLSLW1224L

100

11.0

\$1511

\$35

\$20

12"W x 24"D x 50"H - Right

HLSLW1224R

100

11.0

\$1511

\$35

\$20

12"W x 30"D x 50"H - Left

HLSLW1230L

121

13.6

\$1576

\$35

\$20

12"W x 30"D x 50"H - Right

HLSLW1230R

121

13.6

\$1576

\$35







\$20

NOTES:

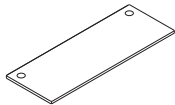
- Tower includes coat hook on back of door.
- Chassis and drawer front panels can be specified separately.
- Tower door is locking. Ships with one handle.
- Support Pedestals bottom file drawers will lock, top box drawers will not.
- Standing-Height Pedestals will have 6" overhang when using 30"D support storage with a 36"D worksurface.
- Use the worksurface to tower bracket kit model HSTB2W1 on page 229 to attach worksurfaces to the Storage Tower models.
- ❗ Pedestals ship fully assembled but must attach to a worksurface with a quick release bracket, provided. Pedestals are non-handed and are interchangeable.
- ❗ Locking units equipped with HON "One Key" interchangeable core removable locks. Keyed alike core must be ordered separately.

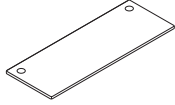
HOW TO SPECIFY

| | | | |
|--|--|---|--|
| <p>Select Model Number</p> <p>H L S L 2 4 4 1 S</p> | <p>Select Chassis Laminate</p> <p>See page 183</p> <p>N</p> | <p>Select Drawer Front Laminate</p> <p>See page 183</p> <p>N</p> | <p>Select Pull Color</p> <p>See page 183</p> <p>T 4</p> |
|--|--|---|--|

| | DESCRIPTION | MODEL | SHIP WEIGHT | CUBE | LIST PRICE BY LAMINATE GRADE | |
|--|-------------------------------|--|-------------|------|------------------------------|--------------|
| | | | | | L1 | L2 |
|  | Rectangle Worksurfaces | | | | | |
| | 48"W x 24"D | HLSLR2448  | 61 | 3.4 | \$337 | \$352 |
| | 54"W x 24"D | HLSLR2454 | 68 | 4.2 | \$363 | \$383 |
| | 60"W x 24"D | HLSLR2460 | 75 | 4.2 | \$394 | \$414 |
| | 66"W x 24"D | HLSLR2466 | 82 | 5.0 | \$428 | \$448 |
| | 72"W x 24"D | HLSLR2472 | 89 | 5.0 | \$443 | \$463 |
|  | Rectangle Worksurfaces | | | | | |
| | 48"W x 30"D | HLSLR3048 | 75 | 4.2 | \$363 | \$378 |
| | 54"W x 30"D | HLSLR3054 | 84 | 5.1 | \$403 | \$423 |
| | 60"W x 30"D | HLSLR3060  | 92 | 5.1 | \$451 | \$471 |
| | 66"W x 30"D | HLSLR3066  | 101 | 6.1 | \$485 | \$505 |
| | 72"W x 30"D | HLSLR3072  | 110 | 6.1 | \$527 | \$547 |

HOW TO SPECIFY

| | | |
|--|--|---|
| <p>Select Model Number</p> <p>HLSLR2448</p> | <p>Select Worksurface Laminate and Edge Color</p> <p>See page 183</p> <p>NN</p> | <p>Select Grommet Option and Color</p> <p>X No Grommet If choosing the grommet option G Grommet Select Grommet Color See page 183</p> <p>GT5</p> |
|--|--|---|

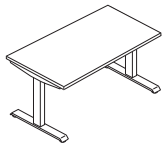

DESCRIPTION

Coordinate™ Height Adjustable Base – 2 Stage

- 2-Leg Rectangle T Foot
- 2-Leg Rectangle C Foot

MODEL

SHIP WEIGHT

CUBE

LIST PRICE

| | | | |
|-------------------|----|-----|--------------|
| HHATB2S2LT | 66 | 2.4 | \$950 |
| HHATB2S2LC | 66 | 2.4 | \$950 |

NOTES:

- Dual motor two-leg design. Legs raise from 25⁵/₈" to 45¹/₄".
- Base accommodates any rectangular worksurface between 23"D x 40"W and 30"D x 72"W.
- Weight capacity of 250 lbs. (including the weight of the worksurface) distributed evenly.

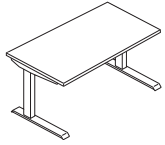

Coordinate™ Height Adjustable Base – 3 Stage

- 2-Leg Rectangle T Foot
- 2-Leg Rectangle C Foot

| | | | |
|-------------------|----|-----|---------------|
| HHATB3S2LT | 66 | 2.4 | \$1047 |
| HHATB3S2LC | 66 | 2.4 | \$1047 |

NOTES:

- Dual motor two-leg design. Legs raise from 21⁵/₈" to 47³/₄".
- Base accommodates any rectangular worksurface between 23"D x 40"W and 30"D x 72"W.
- Weight capacity of 250 lbs. (including the weight of the worksurface) distributed evenly.

Coordinate™ Height Adjustable Base – Max 3 Stage

- 2-Leg Rectangle T Foot

| | | | |
|-------------------|----|-----|---------------|
| HHATM3S2LT | 66 | 2.4 | \$1173 |
|-------------------|----|-----|---------------|

NOTES:

- Dual motor two-leg design. Legs raise from 21⁵/₈" to 47³/₄".
- Base accommodates any rectangular worksurface between 23"D x 40"W and 30"D x 96"W.
- Weight capacity of 350 lbs. (including the weight of the worksurface) distributed evenly.

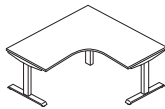

Coordinate™ Height Adjustable Base – 3 Stage

- 3-Leg Rectangle T Foot
- 3-Leg Rectangle C Foot

| | | | |
|-------------------|----|-----|---------------|
| HHATB3S3LT | 91 | 3.6 | \$1729 |
| HHATB3S3LC | 91 | 3.6 | \$1729 |

NOTES:

- Tri-motor three-leg design. Legs raise from 21⁵/₈" to 47³/₄".
- Base accommodates worksurfaces between 23"D x 40"W x 40"W and 30"D x 72"W x 72"W. Can be used with 48" 120° worksurface models.
- Weight capacity of 375 lbs. (including the weight of the worksurface) distributed evenly.

ⓘ When using two worksurfaces, a flat bracket is required. Bracket purchased separately — HHN831124, HHN831130 — see page 632.

NOTES:





- Control Box: 120V, 4A, 60Hz, 400W.
- 9' grounded power cord.
- 1¹/₈" second travel speed.
- <50 dB noise rating.
- **HON 10-Year Warranty.**

ⓘ Requires the use of an external stiffener (purchased separately) for worksurfaces over 58"W or wider when not used with a Coordinate™ worksurface.

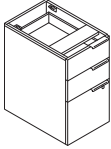

HOW TO SPECIFY

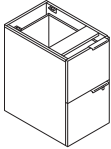
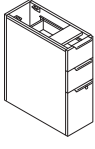
| | | | |
|---|---|---|--|
| <p>Select Model Number</p> <p>HHATB3S2LT</p> | <p>Select Paint Color</p> <p>See page 116</p> <p>P71</p> | <p>Select Foot</p> <p>X Standard Foot S Slide Glide</p> <p>X</p> | <p>Select Keypad</p> <p>UD Basic Up/Down MEM Memory Preset PDL Paddle RTG Rotating (+ \$50) FPD Foot Pedal (+ \$175)</p> <p>MEM</p> |
|---|---|---|--|



| | DESCRIPTION | MODEL | SHIP WEIGHT | CUBE | L1 LIST | L2 UPCHARGES | |
|--|--|--|-------------|------|--------------|--------------|-------------|
| | | | | | | CHASSIS | FRONTS |
|  | Support Pedestals — Box/Box/File | | | | | | |
| | 16"W x 20"D x 28½"H | HLSL2028B | 73 | 7.3 | \$773 | \$15 | \$10 |
| | 16"W x 24"D x 28½"H | HLSL2428B  | 85 | 8.5 | \$855 | \$20 | \$10 |
| | 16"W x 30"D x 28½"H | HLSL3028B | 105 | 10.5 | \$962 | \$25 | \$10 |
| | NOTES: Top box drawer does not lock. | | | | | | |
|  | Support Pedestals — File/File | | | | | | |
| | 16"W x 20"D x 28½"H | HLSL2028F | 72 | 7.3 | \$773 | \$15 | \$10 |
| | 16"W x 24"D x 28½"H | HLSL2428F | 84 | 8.5 | \$855 | \$20 | \$10 |
| | 16"W x 30"D x 28½"H | HLSL3028F | 104 | 10.5 | \$962 | \$25 | \$10 |
| | NOTES: Unit is locking. | | | | | | |
|  | Slim Profile Pedestals — Box/Box/File | | | | | | |
| | 9½"W x 24"D x 28½"H | HLSL2428S | 69 | 6.9 | \$848 | \$20 | \$10 |
| | 9½"W x 30"D x 28½"H | HLSL3028S | 56 | 5.6 | \$931 | \$25 | \$10 |
| | NOTES: Top box drawer does not lock.  Grommet will be located under Slim Pedestal when attached. | | | | | | |

NOTES:



- A variety of pedestals, end panels, and O-legs can be combined to create a conventional or contemporary desk.
- Chassis and drawer front woodgrain and solid laminates are specified separately (see SIF options below).
- Will have a 6" overhang when using 30" worksurface supports with a 36"D worksurface.
- File drawers accept hanging folders in letter or legal size.
- Multiple handle locations possible per customer preference.
- Ships with one handle per drawer.
- Drawer Organizer model HLSLDRWORG works with box drawers.
- Box and file drawers operate on ball-bearing suspension with full extension.
- Adjustable hex leveling glides allow floor-standing furniture to be easily leveled without lifting the unit; glides have 1¼" adjustable range.
-  Pedestals ship fully assembled but must attach to a worksurface with a quick release bracket, provided. Pedestals are non-handed and are interchangeable.
-  Locking units equipped with HON "One Key" interchangeable core removable locks. Keyed alike core must be ordered separately.

HOW TO SPECIFY

| | | | |
|---|---|--|--|
| Select Model Number HLSL2028B | Select Chassis Laminate See page 183 N | Select Drawer Front Laminate See page 183 N | Select Pull Color See page 183 T4 |
|---|---|--|--|

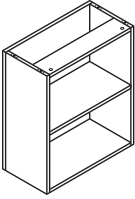

Laminate Support/Support Storage

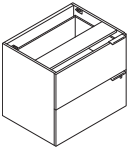
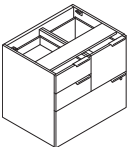
| | DESCRIPTION | MODEL | SHIP WEIGHT | CUBE | L1 LIST | L2 UPCHARGES | |
|---|--|--------------------------------------|-------------|------------|------------------------------|----------------------------|-------------|
| | | | | | | CHASSIS | FRONTS |
|  | Bookcase Support 24"W x 12"D x 28½"H 30"W x 12"D x 28½"H Specify: Model.Laminate SPECIFYING EXAMPLE: HLSL24OBC.N | HLSL24OBC HLSL30OBC | 60 75 | 3.0 3.0 | \$574 \$600 | \$20 \$25 | N/A N/A |
| |  | | | | | | |
|  | Lateral File — 2 Drawer 31⅜"W x 24"D x 28½"H NOTES: Unit is locking. | HLSL2430L | 121 | 15.6 | \$1325 | \$35 | \$20 |
|  | Multi File Lateral File 31⅜"W x 24"D x 28½"H NOTES: Box drawers do not lock. | HLSL2430MF | 163 | 15.6 | \$1574 | \$35 | \$20 |

NOTES:

- Ships with one handle per drawer on all units.
- A variety of pedestals, end panels, and O-legs can be combined to create conventional or contemporary desk.
- Bookcase can only mount exterior facing under a worksurface.
- Chassis and drawer front woodgrain and solid laminates are specified separately (see SIF options below).
- File drawers accept hanging folders in letter or legal size.
- Multiple handle locations possible per customer preference.
- Storage accessory model HLSLDRWORG works with box doors.
- Standard box drawers operate on ball-bearing suspension with full extension. File, lateral, and wide box drawers operate on ball-bearing suspension with full extension.
- Adjustable hex leveling glides allow floor-standing furniture to be easily leveled without lifting the unit; glides have 2" adjustable range.
- When using two lateral files, a 60" worksurface cannot be used, a 66" worksurface must be specified, which will show a gap.

! A single multi file or lateral file must be specified under a worksurface 60"W or wider.

! Locking units equipped with HON "One Key" interchangeable core removable locks. Keyed alike core must be ordered separately.

HOW TO SPECIFY

| | | | |
|---|---|---|--|
| Select Model Number HLSL2430L | Select Chassis Laminate See page 183 N | Select Laminate See page 183 N | Select Pull Color See page 183 T4 |
|---|---|---|--|

VOI® Modesty Panels

GSA SIN 33721

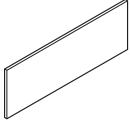
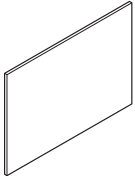
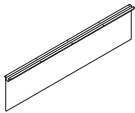

Icon Legend on page 19

| | DESCRIPTION | MODEL | SHIP WEIGHT | CUBE | LIST PRICE BY LAMINATE GRADE | |
|---|--|-------------------|-------------|------|------------------------------|--------------|
| | | | | | L1 | L2 |
|  | Full Width/Half-height Laminate Modesty Panel | | | | | |
| | 28"W x 14"H, for use with 60" desks | HLSL2814LM | 19 | 1.6 | \$208 | \$218 |
| | 34"W x 14"H, for use with 66" desks | HLSL3414LM | 23 | 1.9 | \$215 | \$225 |
| | 40"W x 14"H, for use with 72" desks | HLSL4014LM | 29 | 2.4 | \$224 | \$234 |
| | NOTES: Three sizes available for 60", 66" and 72" desks. Can only be used when using end panels and pedestals for support. | | | | | |
|  | Full-to-Floor/Full-Length Laminate Modesty Panel | | | | | |
| | 28"W x 28½"H, for use with 60" desks | HLSL2828LM | 33 | 2.7 | \$277 | \$289 |
| | 34"W x 28½"H, for use with 66" desks | HLSL3428LM | 38 | 3.2 | \$326 | \$338 |
| | 40"W x 28½"H, for use with 72" desks | HLSL4028LM | 44 | 3.6 | \$343 | \$355 |
| | NOTES: Three sizes available for 60", 66" and 72" desks. Can only be used when using end panels and pedestals for support. | | | | | |
|  | Laminate Floating Modesty Panel | | | | | |
| | 30"W x 14"H | HLSL3014L | 10 | 0.8 | \$191 | \$201 |
| | 36"W x 14"H | HLSL3614L | 12 | 0.8 | \$202 | \$212 |
| | 42"W x 14"H | HLSL4214L | 14 | 0.8 | \$214 | \$224 |
| | 48"W x 14"H | HLSL4814L | 16 | 1.1 | \$236 | \$248 |
| | 54"W x 14"H | HLSL5414L | 18 | 1.1 | \$258 | \$270 |
| | 60"W x 14"H | HLSL6014L | 20 | 1.1 | \$277 | \$289 |
| NOTES: The attachment bracket and modesty panel are packaged separately. Specify: Model.Laminate.Paint SPECIFYING EXAMPLE: HLSL3014L.N (Black is the only paint option for this model) | | | | | | |
| ⓘ When specifying the 54"W or 60"W Laminate Floating Modesty Panel, it is not necessary to specify an external channel. | | | | | | |
| ⓘ 30"W and 36"W screens attach with L-brackets, not the external channel. | | | | | | |

NOTES:

- Full width laminate modesty panel (14"H) and full width/full-length laminate modesty panels are designed to work with 60", 66", & 72" desks.
- Laminate and frosted translucent laminate are available options on modesty panels.
- Full height and half height laminate modesty panels can only be used when specifying a pedestal and/or end panel.

HOW TO SPECIFY

| | |
|----------------------------|------------------------|
| Select Model Number | Select Laminate |
| HLSL2814LM | See page 183 |
| N | |

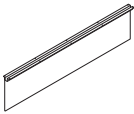

DESCRIPTION

Mixed Material Floating Modesty Panel

- 30"W x 14"H
- 36"W x 14"H
- 42"W x 14"H
- 48"W x 14"H
- 54"W x 14"H
- 60"W x 14"H

MODEL

- HLSL3014MM**
- HLSL3614MM**
- HLSL4214MM** ☉
- HLSL4814MM** ☉
- HLSL5414MM** ☉
- HLSL6014MM** ☉

SHIP WEIGHT

- 8
- 8
- 9
- 11
- 13
- 13

CUBE

- 2.0
- 2.0
- 2.3
- 2.6
- 3.3
- 3.3

LIST PRICE

- \$755**
- \$810**
- \$906**
- \$1002**
- \$1089**
- \$1243**

NOTES: The attachment bracket and modesty panel are packaged separately.

Specify: Model.Mixed Material.Paint

SPECIFYING EXAMPLE: HLSL3014MM.FT01 (Frosted Translucent mixed material and Black paint are the only options for this model)

! When specifying the 54"W or 60"W Mixed Material Floating Modesty Panel, it is not necessary to specify an external channel.

NOTES:

- Full width laminate modesty panel (14"H) and full width/full-length laminate modesty panels are designed to work with 60", 66", & 72" desks.
- Laminate and frosted translucent laminate are available options on modesty panels.
- Full height and half height laminate modesty panels can only be used when specifying a pedestal and/or end panel.

FLOATING MODESTY SELECTION GUIDE

| Support Combination | | Top Size | | | | | | | | |
|-----------------------|-----------------------|----------|----------|----------|----------|----------|----------|----------|-------|-------|
| Support 1 | Support 2 | 84 in | 72 in | 66 in | 60 in | 54 in | 48 in | 42 in | 36 in | 30 in |
| O-Leg/Angled Leg | O-Leg/Angled Leg | NA | HLSL6014 | HLSL5414 | HLSL4814 | HLSL4214 | HLSL3614 | HLSL3014 | NA | NA |
| O-Leg/Angled Leg | Slim Profile Pedestal | HLSL6014 | HLSL5414 | HLSL4814 | HLSL4214 | HLSL3614 | HLSL3014 | NA | NA | NA |
| O-Leg/Angled Leg | Bookcase | HLSL6014 | HLSL5414 | HLSL4814 | HLSL4214 | HLSL3614 | HLSL3014 | NA | NA | NA |
| O-Leg/Angled Leg | Pedestal | HLSL6014 | HLSL4814 | HLSL4214 | HLSL3614 | HLSL3014 | NA | NA | NA | NA |
| O-Leg/Angled Leg | End-Panel | HLSL6014 | HLSL4814 | HLSL4214 | HLSL3614 | HLSL3014 | NA | NA | NA | NA |
| Slim Profile Pedestal | Slim Profile Pedestal | HLSL6014 | HLSL4814 | HLSL4214 | HLSL3614 | HLSL3014 | NA | NA | NA | NA |
| Slim Profile Pedestal | Bookcase | HLSL6014 | HLSL4814 | HLSL4214 | HLSL3614 | HLSL3014 | NA | NA | NA | NA |
| Slim Profile Pedestal | Pedestal | HLSL5414 | HLSL4214 | HLSL3614 | HLSL3014 | NA | NA | NA | NA | NA |
| Slim Profile Pedestal | End-Panel | HLSL5414 | HLSL4214 | HLSL3614 | HLSL3014 | NA | NA | NA | NA | NA |
| Pedestal | Bookcase | HLSL5414 | HLSL4214 | HLSL3614 | HLSL3014 | NA | NA | NA | NA | NA |
| End-Panel | Bookcase | HLSL5414 | HLSL4214 | HLSL3614 | HLSL3014 | NA | NA | NA | NA | NA |
| Bookcase | Bookcase | HLSL5414 | HLSL4214 | HLSL3614 | HLSL3014 | NA | NA | NA | NA | NA |
| End-Panel | End-Panel | HLSL4814 | HLSL3614 | HLSL3014 | NA | NA | NA | NA | NA | NA |
| Pedestal | Pedestal | HLSL4814 | HLSL3614 | HLSL3014 | NA | NA | NA | NA | NA | NA |
| Pedestal | End-Panel | HLSL4814 | HLSL3614 | HLSL3014 | NA | NA | NA | NA | NA | NA |
| O-Leg/Angled Leg | Lateral/Multifile | HLSL4214 | HLSL3614 | HLSL3014 | NA | NA | NA | NA | NA | NA |
| Bookcase | Lateral/Multifile | HLSL3614 | NA | NA | NA | NA | NA | NA | NA | NA |
| Slim Profile Pedestal | Lateral/Multifile | HLSL3614 | NA | NA | NA | NA | NA | NA | NA | NA |
| Pedestal | Lateral/Multifile | HLSL3014 | NA | NA | NA | NA | NA | NA | NA | NA |
| End-Panel | Lateral/Multifile | HLSL3014 | NA | NA | NA | NA | NA | NA | NA | NA |

HOW TO SPECIFY

| | |
|--|---|
| <p>Select Model Number</p> <p>HLSL3014MM.</p> | <p>Select Mixed Material</p> <p>FT01 Frosted Translucent</p> <p>FT01</p> |
|--|---|

VOI® Privacy Screens

GSA SIN 33721



Icon Legend on page 19

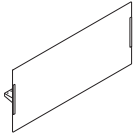

DESCRIPTION

Above/Below Privacy Screen

- 30"W x 28"H
- 36"W x 28"H
- 42"W x 28"H
- 48"W x 28"H
- 54"W x 28"H
- 60"W x 28"H

MODEL

- HLSL2830**
- HLSL2836**
- HLSL2842**
- HLSL2848**
- HLSL2854**
- HLSL2860**

SHIP WEIGHT

- 6
- 6
- 6
- 8
- 9
- 9

CUBE

- 6.4
- 6.4
- 6.3
- 8.2
- 8.6
- 8.6

LIST PRICE

- \$896**
- \$1240**
- \$1253**
- \$1336**
- \$1556**
- \$1565**

NOTES: Attachment bracket extends 2" into the worksurface. Brackets are Platinum only, no need to specify.

! Available in Frosted Translucent Acrylic ONLY HLSL2830.FT01.

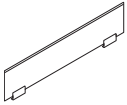

Above Privacy Screen

- 30"W x 13"H
- 36"W x 13"H
- 42"W x 13"H
- 48"W x 13"H
- 54"W x 13"H
- 60"W x 13"H

- HLSL1230**
- HLSL1236**
- HLSL1242**
- HLSL1248**
- HLSL1254**
- HLSL1260**

- 13
- 15
- 18
- 20
- 22
- 24

- 1.5
- 1.8
- 2.3
- 2.3
- 2.9
- 2.9

- \$313**
- \$345**
- \$387**
- \$443**
- \$473**
- \$508**

NOTES: Bracket is Platinum only, no need to specify.

! Available in Frosted Glass ONLY HLSL1230.G.

! Above only Privacy Screen clamps onto worksurface and cannot be installed where support storage will be attached.

NOTES:

- Ships complete with attachment brackets.
- Voi® Privacy Screens can be used on the HON Height Adjustable Base.
- All brackets are Platinum.
- Above Privacy Screen attaches to top of worksurface.
- Above and Below Privacy Screen extends 13" above and 13" below the worksurface.
- ! Above/Below Privacy Screens cannot be used with Knife Edge worksurfaces.

ABOVE-BELOW PRIVACY SCREEN SELECTION GUIDE

| Support Combination | | Top Size | | | | | | | | |
|-----------------------|-----------------------|----------|----------|----------|----------|----------|----------|----------|-------|-------|
| Support 1 | Support 2 | 84 in | 72 in | 66 in | 60 in | 54 in | 48 in | 42 in | 36 in | 30 in |
| O-Leg/Angled Leg | O-Leg/Angled Leg | NA | HLSL2860 | HLSL2854 | HLSL2848 | HLSL2842 | HLSL2836 | HLSL2830 | NA | NA |
| O-Leg/Angled Leg | Slim Profile Pedestal | HLSL2860 | HLSL2854 | HLSL2848 | HLSL2842 | HLSL2836 | HLSL2830 | NA | NA | NA |
| O-Leg/Angled Leg | Bookcase | HLSL2860 | HLSL2854 | HLSL2848 | HLSL2842 | HLSL2836 | HLSL2830 | NA | NA | NA |
| O-Leg/Angled Leg | Pedestal | HLSL2860 | HLSL2848 | HLSL2842 | HLSL2836 | HLSL2830 | NA | NA | NA | NA |
| O-Leg/Angled Leg | End-Panel | HLSL2860 | HLSL2848 | HLSL2842 | HLSL2836 | HLSL2830 | NA | NA | NA | NA |
| Slim Profile Pedestal | Slim Profile Pedestal | HLSL2860 | HLSL2848 | HLSL2842 | HLSL2836 | HLSL2830 | NA | NA | NA | NA |
| Slim Profile Pedestal | Bookcase | HLSL2860 | HLSL2848 | HLSL2842 | HLSL2836 | HLSL2830 | NA | NA | NA | NA |
| Slim Profile Pedestal | Pedestal | HLSL2854 | HLSL2842 | HLSL2836 | HLSL2830 | NA | NA | NA | NA | NA |
| Slim Profile Pedestal | End-Panel | HLSL2854 | HLSL2842 | HLSL2836 | HLSL2830 | NA | NA | NA | NA | NA |
| Pedestal | Bookcase | HLSL2854 | HLSL2842 | HLSL2836 | HLSL2830 | NA | NA | NA | NA | NA |
| End-Panel | Bookcase | HLSL2854 | HLSL2842 | HLSL2836 | HLSL2830 | NA | NA | NA | NA | NA |
| Bookcase | Bookcase | HLSL2854 | HLSL2842 | HLSL2836 | HLSL2830 | NA | NA | NA | NA | NA |
| End-Panel | End-Panel | HLSL2848 | HLSL2836 | HLSL2830 | NA | NA | NA | NA | NA | NA |
| Pedestal | Pedestal | HLSL2848 | HLSL2836 | HLSL2830 | NA | NA | NA | NA | NA | NA |
| Pedestal | End-Panel | HLSL2848 | HLSL2836 | HLSL2830 | NA | NA | NA | NA | NA | NA |
| O-Leg/Angled Leg | Lateral/Multifile | HLSL2842 | HLSL2836 | HLSL2830 | NA | NA | NA | NA | NA | NA |
| Bookcase | Lateral/Multifile | HLSL2836 | NA | NA | NA | NA | NA | NA | NA | NA |
| Slim Profile Pedestal | Lateral/Multifile | HLSL2836 | NA | NA | NA | NA | NA | NA | NA | NA |
| Pedestal | Lateral/Multifile | HLSL2830 | NA | NA | NA | NA | NA | NA | NA | NA |
| End-Panel | Lateral/Multifile | HLSL2830 | NA | NA | NA | NA | NA | NA | NA | NA |

HOW TO SPECIFY

Select Model Number

HLSL2830 .

HLSL1230 .

Select Mixed Material

FT01 Frosted Translucent Acrylic
Specified for Above/Below Privacy Screens only

G Frosted Glass
Specified for Above Privacy Screens only

FT01

G

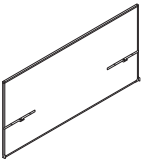
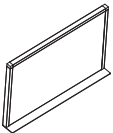

| | DESCRIPTION | MODEL | SHIP WEIGHT | CUBE | CORE LIST PRICE BY CODE | |
|--|---|--------------------|-------------|---------------|-------------------------|---------------|
| | | | | | A | B |
|  | Above/Below Fabric Privacy Screen | | | | | |
| | 36"W x 35"H | HLSSL3635TS | 21 | 3.8 | \$965 | \$990 |
| | 42"W x 35"H | HLSSL4235TS | 27 | 4.4 | \$1014 | \$1039 |
| | 48"W x 35"H | HLSSL4835TS | 33 | 6.0 | \$1078 | \$1113 |
| | 54"W x 35"H | HLSSL5435TS | 39 | 6.0 | \$1126 | \$1161 |
| | 60"W x 35"H | HLSSL6035TS | 45 | 6.0 | \$1196 | \$1239 |
| | 66"W x 35"H | HLSSL6635TS | 51 | 7.4 | \$1260 | \$1303 |
| 72"W x 35"H | HLSSL7235TS | 57 | 7.4 | \$1314 | \$1357 | |
| NOTES: Brackets are Platinum only, no need to specify. Above/Below Privacy Screens must be ordered the same width as the worksurface it is being used with to properly attach. | | | | | | |
|  | Above Fabric (Side) Privacy Screen | | | | | |
| | 20"W x 20"H | HLSSL2020TS | 13 Ⓞ | 1.4 | \$375 | \$382 |
| | 24"W x 20"H | HLSSL2024TS | 15 Ⓞ | 1.4 | \$385 | \$393 |
| | 30"W x 20"H | HLSSL2030TS | 17 Ⓞ | 1.9 | \$403 | \$414 |
| | 36"W x 20"H | HLSSL2036TS | 19 Ⓞ | 2.2 | \$444 | \$457 |
| | 20"W x 13"H | HLSSL1220TS | 11 Ⓞ | 1.1 | \$358 | \$364 |
| | 24"W x 13"H | HLSSL1224TS | 13 Ⓞ | 1.1 | \$366 | \$372 |
| | 30"W x 13"H | HLSSL1230TS | 15 Ⓞ | 1.6 | \$381 | \$388 |
| | 36"W x 13"H | HLSSL1236TS | 17 Ⓞ | 1.9 | \$405 | \$413 |
| | NOTES: Brackets are Platinum only, no need to specify. Brackets intended to be attached between users sitting side-by-side, and will create 1/8" separation between worksurfaces. | | | | | |

NOTES:

- Ships complete with attachment brackets.
 - All brackets are Platinum.
 - Above Privacy Screen attaches to top and side of worksurface with adhesive banding.
 - Lower attachment brackets may be shifted to attach to support components.
 - Above/Below Privacy Screen extends 20" above and 13" below worksurface.
- ❗ Screens cannot be used with T-mold on series such as tables. Screens can only attach to edgeband. Surfaces must be cleaned prior to adhering the screen and must be left to cure for 24 hours without touching for best adhesion.
- ❗ Above/Below Fabric Privacy Screens can attach to worksurfaces that are either O-leg supported on both sides, or worksurfaces that are supported by a support pedestal on one side and an O-leg on the other. They cannot be attached to worksurfaces supported by support pedestals on both sides, unless additional hardware is specified.
- ❗ Above Screens must attach to edgeband and top of surface.
- ❗ Above/Below Privacy Screens must be ordered the same width as the worksurface it is being used with to properly attach.
- ❗ Above/Below Privacy Screens cannot be used with Knife Edge worksurfaces.
- ❗ Shared O-legs should not be used with Above/Below Fabric Privacy Screens.

HOW TO SPECIFY

| | |
|----------------------------|----------------------|
| Select Model Number | Select Fabric |
| | See pages 25-26 |
| HLSSL3635TS | PN15 |

VOI® Privacy Screens

GSA SIN 33721

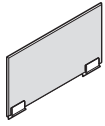

Icon Legend on page 19

**DESCRIPTION****Above Frosted Polymer (Side) Privacy Screen**

20"W x 13"H

24"W x 13"H

30"W x 13"H

36"W x 13"H

MODEL**HLSL1220FS****HLSL1224FS****HLSL1230FS****HLSL1236FS****SHIP WEIGHT**

12

14

16

19

CUBE

1.3

1.4

1.6

1.9

LIST PRICE**\$347****\$369****\$399****\$447**

NOTES: Brackets are Platinum only, no need to specify. Brackets intended to be attached between users sitting side-by-side, and will create 1/8" separation between workspaces.

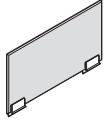
**Above Frosted Glass (Side) Privacy Screen**

20"W x 13"H

24"W x 13"H

30"W x 13"H

36"W x 13"H

HLSL1220GS**HLSL1224GS****HLSL1230GS****HLSL1236GS**

13

16

18

20

1.3

1.4

1.6

1.9

\$290**\$308****\$333****\$371**

NOTES: Brackets are Platinum only, no need to specify. Brackets intended to be attached between users sitting side-by-side, and will create 1/8" separation between workspaces.

NOTES:

- Above Privacy Screens are intended to be attached between users sitting side-by-side but will create 1/8" spacing between the workspaces. Please consider stack up if using in a panel-wrapped application.
 - Ships complete with attachment brackets.
 - All brackets are Platinum.
 - Above Privacy Screen attaches to top and side of worksurface with adhesive banding.
 - Lower attachment brackets may be shifted to attach to support components.
 - Above/Below Privacy Screen extends 20" above and 13" below worksurface.
- ⓘ Screens cannot be used with T-mold on series such as tables. Screens can only attach to edgeband. Surfaces must be cleaned prior to adhering the screen and must be left to cure for 24 hours without touching for best adhesion.

HOW TO SPECIFY**Select
Model Number**

HLSL1220FS
HLSL1220GS

**Select
Mixed Material****FT01** Frosted Translucent Acrylic

Specified for Above Screen models HLSL1220FS-HLSL1236FS only

G Frosted Glass

Specified for Above Screen models HLSL1220GS-HLSL1236GS only

FT01
G



Laminate Overhead Storage

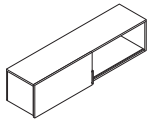

DESCRIPTION

Overhead Cabinet with One Sliding Door

36"W x 14¼"D x 14"H
 42"W x 14¼"D x 14"H
 48"W x 14¼"D x 14"H
 60"W x 14¼"D x 14"H
 66"W x 14¼"D x 14"H
 72"W x 14¼"D x 14"H

| MODEL | SHIP WEIGHT | CUBE | L1 LIST | L2 UPCHARGES | |
|------------------|-------------|------|---------------|--------------|-------------|
| | | | | CABINET | DOOR |
| HLSL1436S | 39 | 9.7 | \$1120 | \$25 | \$20 |
| HLSL1442S | 48 | 9.7 | \$1174 | \$25 | \$20 |
| HLSL1448S | 57 | 12.1 | \$1208 | \$25 | \$20 |
| HLSL1460S | 69 | 13.3 | \$1301 | \$30 | \$25 |
| HLSL1466S | 83 | 14.6 | \$1436 | \$30 | \$25 |
| HLSL1472S | 95 | 15.9 | \$1567 | \$35 | \$25 |

NOTES:

- Sliding door overhead does not ship with a pull — door overhangs chassis to slide.
- If locking unit is selected, HF27 is used for lock core.

HOW TO SPECIFY

| | | | | |
|---|---|--|--|---|
| <p>Select Model Number</p> <p>For locking overhead models, add an "L" suffix (\$40 upcharge per model)</p> <p>H L S L 1 4 7 2 S</p> | <p>Select Cabinet Laminate</p> <p>See page 183</p> <p>N</p> | <p>Select Door Laminate</p> <p>See page 183</p> <p>N</p> | <p>Select Pull Option</p> <p>X No Pull</p> <p>X</p> | <p>Specify Bracket Option</p> <p>X No Bracket W Wall Bracket (\$150 upcharge)</p> <p>W</p> |
|---|---|--|--|---|

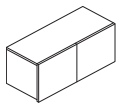

DESCRIPTION

Overhead Cabinet with Doors

36"W x 14¼"D x 14"H, 2 doors
 42"W x 14¼"D x 14"H, 2 doors
 48"W x 14¼"D x 14"H, 3 doors
 60"W x 14¼"D x 14"H, 4 doors

| MODEL | SHIP WEIGHT | CUBE | L1 LIST | L2 UPCHARGES | |
|------------------|-------------|------|---------------|--------------|-------------|
| | | | | CABINET | DOOR |
| HLSL1436D | 39 | 9.7 | \$945 | \$25 | \$20 |
| HLSL1442D | 48 | 9.7 | \$1051 | \$25 | \$20 |
| HLSL1448D | 57 | 12.1 | \$1166 | \$25 | \$30 |
| HLSL1460D | 115 | 13.3 | \$1301 | \$30 | \$30 |

❗ 2-Door and 3-Door Overhead Cabinet with Doors models HLSL1436D–HLSL1448D available in laminate only. The 60" model HLSL1460D is available in all door finish options—see "Select Door Material for 2/3/4 Door Models" below.

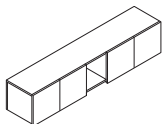

Overhead Cabinet with 4 Doors/Cubbies

66"W x 14¼"D x 14"H with 6" Cubbie
 72"W x 14¼"D x 14"H with 12" Cubbie

| | | | | | |
|------------------|-----|------|---------------|-------------|-------------|
| HLSL1466D | 126 | 14.6 | \$1436 | \$30 | \$30 |
| HLSL1472D | 139 | 15.9 | \$1567 | \$35 | \$35 |

NOTES: Doors available in laminate or mixed materials.

NOTES:

- All Overhead Cabinets shown above can be used as a wall mount, panel mount or stack-on storage with O-leg.
- Tackboards are available for wall mount storage applications and conventional stack-on. Use wall mount tackboards when using O-leg supports.
- 5½"H and 20½"H O-legs can be purchased to create stack-on storage. Heights line up with Abound® and Accelerate® panels.
- Overhead cabinets with four doors are available in laminate or mixed materials.
- Wall mount brackets specified with unit. Brackets attach to case horizontally.
- Storage cases accept binder height items.
- The Metal Storage Cube HLSL1212 fits inside stack-on storage or overhead cabinet units to provide paper management.
- For panel mounted applications, brackets and hardware are ordered separately, see pages 592-593. Brackets attach to panel and case is screwed into brackets. Two brackets needed for 60" unit.
- If locking unit is selected, HF27 is used for lock core.

❗ Stack-on Storage must be placed over two full-height supports. Cannot be placed over non-supported sections such as returns using a flat bracket or tower-to-worksurface bracket.

❗ TIG doors not available with a locking option.

HOW TO SPECIFY

| | | | |
|---|---|---|--|
| <p>Select Model Number</p> <p>For locking overhead models, add an "L" suffix (\$40 upcharge per model)</p> <p>H L S L 1 4 6 0 D</p> | <p>Select Cabinet Laminate</p> <p>See page 183</p> <p>N</p> | <p>Select Door Material for 2/3/4 Door Models</p> <p>Upcharge for door selection: 4-Door \$315</p> <p>TIG Platinum Polymer with Frosted glass</p> <p>Also available in laminate doors. See page 183. Not specified for models HLSL1436D–HLSL1448D. These models are available in laminate only.</p> <p>TIG</p> | <p>Select Bracket Option</p> <p>X No Bracket W Wall Bracket (\$150 upcharge)</p> <p>X</p> |
|---|---|---|--|

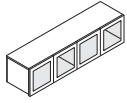

| DESCRIPTION | MODEL | SHIP WEIGHT | CUBE | LIST PRICE BY LAMINATE GRADE | |
|---|------------------|-------------|------|------------------------------|---------------|
| | | | | L1 | L2 |
| Overhead Cabinet with 4 Frosted, Metal Frame Doors 60"W x 14¼"D x 14"H ⓘ Must specify an X or W for attachment bracket option below. | HLSL1460M | 115 | 11.4 | \$2141 | \$2171 |

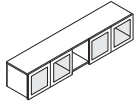

| |
|--|
| Overhead Cabinet with 4 Frosted, Metal Frame Doors 72"W x 14¼"D x 14"H with 12" Cubbie HLSL1472M 139 13.6 \$2412 \$2447 |
| 66"W x 14¼"D x 14"H with 6" Cubbie HLSL1466M 126 12.5 \$2275 \$2305 |
| ⓘ Must specify an X or W for attachment bracket option below. |

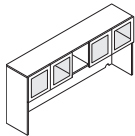

| |
|--|
| Stack-on Storage, Built-up with 4 Frosted Doors with Metal Frame with Cubbies 72"W x 14¼"D x 35"H with 12" Cubbie HLSL1472MB 165 30.4 \$2541 \$2586 |
| NOTES: Ships complete with Back Enclosure and laminate End Panels. Ships factory assembled. ⓘ Does not require bracket specification. |

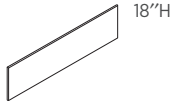

| DESCRIPTION | MODEL | SHIP WEIGHT | CUBE | LIST PRICE BY FABRIC GRADE | |
|---|-------|-------------|------|----------------------------|---|
| | | | | A | B |
| Tackboard for Wall Mount Overhead Cabinets For 78"W HLSL78TW 13 1.4 \$419 \$431 For 72"W HLSL72TW 12 1.4 \$399 \$411 For 66"W HLSL66TW 11 1.4 \$382 \$394 For 60"W HLSL60TW 10 1.1 \$339 \$351 For 48"W HLSL48TW 13 1.4 \$295 \$305 For 42"W HLSL42TW 12 1.4 \$275 \$285 For 36"W HLSL36TW 11 1.4 \$259 \$269 | | | | | |
| SPECIFYING EXAMPLE: HLSL48TW.DB30 | | | | | |

NOTES:



- Use O-Leg Support models for Overhead Cabinets. See page 218.
- The Metal Storage Cube HLSL1212 fits inside stack-on storage or wall mount units to provide paper management. See page 218.
- ⓘ Metal Frame Overhead and Stack-on Storage units are not available with a lock.
- ⓘ Stack-on Storage must be placed over two full-height supports. Cannot be placed over non-supported sections such as returns using a flat bracket or tower-to-worksurface bracket.
- ⓘ Specify fabric, see pages 25-26. Upcharges may apply to premium fabric grades. Analog (ANLG), Disperse (DISP), and Exchange (EXG) not available on sizes wider than 72".

HOW TO SPECIFY

| | | | |
|---|--|---|---|
| Select Model Number HLSL1460M . N . | Select Cabinet Laminate See page 183 | Select Door Material TIG Platinum Metal Doors with Frosted Glass (no upcharge) | Select Bracket Option X No Bracket W Wall Bracket (\$150 upcharge) Not specified for model HLSL1472MB |
|---|--|---|---|

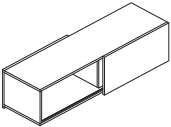
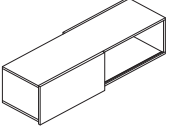

Laminate Shared Overhead Storage Components

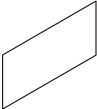
| | DESCRIPTION | MODEL | SHIP WEIGHT | CUBE | L1 LIST | L2 UPCHARGES | |
|---|---|--|----------------------------|--------------|--------------------------------|------------------------------|------------------------------|
| | | | | | | CABINET | DOOR |
|  | Shared Overhead Storage — Left | | | | | | |
| | 60"W x 17"D x 14"H 72"W x 17"D x 14"H | HLSL1760SOL HLSL1772SOL | 115 139 | 14.8 17.0 | \$1429 \$1723 | \$20 \$25 | \$40 \$40 |
|  | Shared Overhead Storage — Right | | | | | | |
| | 60"W x 17"D x 14"H 72"W x 17"D x 14"H | HLSL1760SOR HLSL1772SOR | 115 139 | 14.8 17.0 | \$1429 \$1723 | \$20 \$25 | \$40 \$40 |
| | DESCRIPTION | MODEL | SHIP WEIGHT | CUBE | LIST PRICE BY PAINT GRADE | | |
|  | Post Legs for Shared Storage | | | | P1 | P2 | P3 |
| | 14"H Post Legs 22"H Post Legs | HLSL14OSPL HLSL22OSPL | 10 Ⓔ 13 Ⓔ | 1.1 3.7 | \$381 \$422 | \$385 \$426 | \$401 \$442 |
| | NOTES: 14"H post legs on worksurfaces will span 35"H panel or shorter. 14"H post legs on low credenzas will span 30"H panel or shorter. 22"H post legs on worksurfaces will span 50"H panel or shorter. 22"H post legs on low credenzas will span 35"H panel or shorter. Specify paint. SPECIFYING EXAMPLE: HLSL14OSPL.T4 | | | | | | |
|  | Panel Mount Bracket for Shared Overhead | | | | | | |
| | Panel Mount Bracket for Overhead Storage — Accelerate® | HLSLPMBSOA | 4 Ⓔ | 0.1 | \$150 | \$154 | N/A |
| | Panel Mount Bracket for Overhead Storage — Abound® | HLSLPMBSOB | 4 Ⓔ | 0.1 | \$150 | \$154 | N/A |
| | Panel Mount Bracket for Overhead Storage — Accelerate®/Abound® 42½"H panels only | HLSLPMBSO42 | 4 Ⓔ | 0.1 | \$140 | \$144 | N/A |
| | NOTES: Specify paint. SPECIFYING EXAMPLE: HLSLPMBSOA.T4 | | | | | | |
|  | Markerboard for Shared Storage | | | | | | |
| | 30"W x 13"H for use with 60"W Shared Overhead 36"W x 13"H for use with 72"W Shared Overhead | HLSL1530SOMB HLSL1536SOMB | 6 Ⓔ 8 Ⓔ | 1.0 1.0 | \$143 \$192 | | |
| | NOTES: No specification necessary. | | | | | | |

NOTES:

- Overall case depth is 19"D including the sliding door.
 - Use Shared Overhead and attachments in small footprint applications.
 - Sliding door is 15"H, providing a 1" valance below the case which can be used as a finger pull if desired.
 - Shared Overhead panel mount brackets and overhead post legs allow overhead to span over all panels systems or run down the spine wall, centered on top of the panel.
 - Post legs can attach to all low credenza models and all worksurface models.
 - Markerboard insert is markerboard laminate with black edges, no frame.
- ⓘ Shared Overhead must be ordered as left or right to determine open storage location.
- ⓘ Shared Overhead Storage is not available with a lock.

HOW TO SPECIFY

| | | |
|--|--|---|
| <p>Select Model Number</p> <p>HLSL1760SOL . N</p> | <p>Select Chassis Laminate</p> <p>See page 183</p> <p>N</p> | <p>Select Door Front Laminate</p> <p>See page 183</p> <p>N</p> |
| <p>Select Model Number</p> <p>HLSL14OSPL . T4</p> | <p>Select Paint Color</p> <p>See page 183</p> <p>T4</p> | |

Overhead Storage Supports/Accessories

Icon Legend on page 19

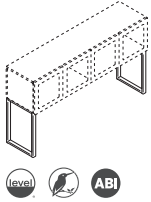

DESCRIPTION

O-Leg Support for Overhead Cabinet

Ships 2/pack
 14 7/8" D x 20 1/2" H
 14 7/8" D x 5 1/2" H

MODEL

HLSL650S
HLSL500S

SHIP WEIGHT

8
 6

CUBE

1.1
 1.0

LIST PRICE BY PAINT GRADE

| P1 | P2 | P3 |
|-------|-------|-------|
| \$526 | \$530 | \$546 |
| \$437 | \$441 | \$457 |

NOTES: 20 1/2" H legs used to reach 65" H when overhead storage is stacked on top of a worksurface. 5 1/2" H legs used to reach 50" H when overhead storage is stacked on top of a worksurface. O-leg ships fully assembled with mounting hardware. O-legs can be used with all overhead cabinet models. See pages 215 and 216.

- ⚠ Not for use on Shared Overhead Storage, use post leg models on page 217.
- ⚠ Stack-on Storage must be placed over two full-height supports. Cannot be placed over non-supported sections such as returns using a flat bracket or tower-to-worksurface bracket.

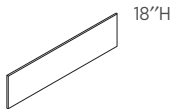

DESCRIPTION

Wall Mounted Tackboards

For 78" W
 For 72" W
 For 66" W
 For 60" W
 For 48" W
 For 42" W
 For 36" W

MODEL

HLSL78TW
HLSL72TW
HLSL66TW
HLSL60TW
HLSL48TW
HLSL42TW
HLSL36TW

SHIP WEIGHT

13
 12
 11
 10
 13
 12
 11

CUBE

1.4
 1.4
 1.4
 1.1
 1.4
 1.4
 1.4

LIST PRICE BY FABRIC GRADE

A B

| A | B |
|-------|-------|
| \$419 | \$431 |
| \$399 | \$411 |
| \$382 | \$394 |
| \$339 | \$351 |
| \$295 | \$305 |
| \$275 | \$285 |
| \$259 | \$269 |

NOTES: Specify fabric, see pages 25-26. Upcharges may apply to premium fabric grades. Analog (ANLG), Disperse (DISP), and Exchange (EXG) not available on sizes wider than 72".

SPECIFYING EXAMPLE: HLSL78TW.APN23



DESCRIPTION

Storage Cube

12" W x 12" D

MODEL

HLSL1212

SHIP WEIGHT

1

CUBE

0.3

LIST PRICE

\$316

SPECIFYING EXAMPLE: HLSL1212.P8S



DESCRIPTION

Shelves

30" W x 13" D
 36" W x 13" D
 45" W x 13" D

MODEL

HLSLR1330
HLSLR1336
HLSLR1345

SHIP WEIGHT

10 Ⓞ
 12 Ⓞ
 15 Ⓞ

CUBE

1.3
 1.5
 1.9

L1 LIST PRICE

\$210
 \$236
 \$256

L2 UPCHARGE

\$10
 \$10
 \$10

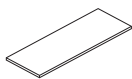

DESCRIPTION

Shelf Bracket (set of 3)

MODEL

HLSLSB

SHIP WEIGHT

3 Ⓞ

CUBE

0.2

LIST PRICE BY PAINT GRADE

| P1 | P2 | P3 |
|-------|-------|-------|
| \$106 | \$114 | \$126 |

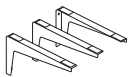

HOW TO SPECIFY

Select Model Number

Select Laminate/Paint

See page 183

HLSL650S.T1



Laminate Stack-on Storage — Built-up

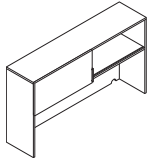

| DESCRIPTION | MODEL | SHIP WEIGHT | CUBE | L1 LIST | L2 UPCHARGES | |
|--|-------------------|-------------|------|---------------|--------------|-------------|
| | | | | | CABINET | DOOR |
| Stack-on Storage, Built-up, with Sliding Doors 72"W x 14¼"D x 35"H | HLSL1472SB | 139 | 30.4 | \$1705 | \$45 | \$20 |

NOTES: Ships complete with Back Enclosure and laminate End Panels. Ships factory assembled.

HOW TO SPECIFY

| | | | |
|----------------------------|--|---|--|
| Select Model Number | Select Cabinet Laminate See page 183 L2 (\$45 upcharge) | Select Door Laminate See page 183 L2 (\$20 upcharge) | Select Pull Option X No Pull |
| HLSL1472SB | N | N | X |

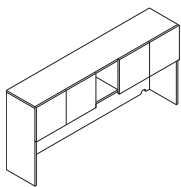

| DESCRIPTION | MODEL | SHIP WEIGHT | CUBE | L1 LIST | L2 UPCHARGES | |
|--|-------------------|-------------|------|---------------|--------------|------------|
| | | | | | CABINET | DOOR |
| Stack-on Storage, Built-up, with 4 Doors/Cubbies 72"W x 14¼"D x 35"H with 12" Cubbie | HLSL1472DB | 144 | 30.4 | \$1705 | \$45 | N/A |

NOTES: Ships complete with Back Enclosure and laminate End Panels. Ships factory assembled.

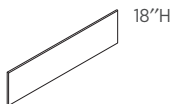

18"H

| DESCRIPTION | MODEL | SHIP WEIGHT | CUBE | LIST PRICE BY FABRIC GRADE | |
|---|-------------------|-------------|------|----------------------------|--------------|
| | | | | A | B |
| Tackboard for Built-up Stack-on Storage For 72" | HLSL7265TE | 12 | 1.4 | \$399 | \$411 |

NOTES: For a list of standard fabrics, see pages 25-26. For a complete list of fabrics, please go to hon.com/fabricsandfinishes. Analog (ANLG), Disperse (DISP), and Exchange (EXG) not available on sizes wider than 72".

SPECIFYING EXAMPLE: HLSL7265TE.APN23

NOTES:

- The Metal Storage Cube HLSL1212 fits inside stack-on storage or wall mount units to provide paper management.

❗ Stack-on Storage is not available with a lock.

❗ Tackboards are available for Built-up models only. Tackboards cannot be added to O-leg supported units.

❗ Stack-on Storage must be placed over two full-height supports. Cannot be placed over non-supported sections such as returns using a flat bracket or tower-to-worksurface bracket.

HOW TO SPECIFY

| | | |
|----------------------------|--|---|
| Select Model Number | Select Cabinet Chassis Laminate See page 183 L2 (\$45 upcharge) | Select Door Material for 4-Door Models Upcharge for door selection: 4-Door T1G Platinum Polymer with Frosted glass \$315 Also available in laminate doors. See page 183. |
| HLSL1472DB | N | T1G |

VOI® Laminate Low Credenzas

GSA SIN 33721



Icon Legend on page 19

| | DESCRIPTION | MODEL | SHIP WEIGHT | CUBE | L1 LIST | L2 UPCHARGES | |
|--|---|--|-------------|------|---------------|--------------|-------------|
| | | | | | | CHASSIS | FRONTS |
|  | Low Credenza, 2 File/2 Box 72"W x 20"D x 21½"H 60"W x 20"D x 21½"H | HLSL2072LD4 | 230 | 21.9 | \$1806 | \$40 | \$40 |
| | NOTES: Unit is locking. | HLSL2060LD4 | 190 | 18.9 | \$1647 | \$35 | \$40 |
|  | Low Credenza, 2 File Drawers, Open Top 72"W x 20"D x 21½"H 60"W x 20"D x 21½"H | HLSL2072LD2 | 200 | 21.9 | \$1688 | \$40 | \$30 |
| | NOTES: Unit is non-locking. | HLSL2060LD2  | 160 | 18.9 | \$1543 | \$35 | \$30 |
|  | Low Credenza, Left Hand Drawers 72"W x 20"D x 21½"H 60"W x 20"D x 21½"H | HLSL2072LL2 | 200 | 21.9 | \$1672 | \$40 | \$20 |
| | NOTES: Unit is locking. | HLSL2060LL2 | 160 | 18.9 | \$1412 | \$35 | \$20 |
|  | Low Credenza, Right Hand Drawers 72"W x 20"D x 21½"H 60"W x 20"D x 21½"H | HLSL2072LR2 | 200 | 21.9 | \$1672 | \$40 | \$20 |
| | NOTES: Unit is locking. | HLSL2060LR2 | 160 | 18.9 | \$1412 | \$35 | \$20 |
|  | Low Credenza, Open 72"W x 20"D x 21½"H 60"W x 20"D x 21½"H | HLSL2072LDO | 170 | 21.9 | \$1421 | \$40 | N/A |
| | SPECIFYING EXAMPLE: HLSL2072LDO.Z (model.chassis only) | HLSL2060LDO | 130 | 18.9 | \$1180 | \$35 | N/A |
|  | Low Credenza, 4 Storage Doors 72"W x 20"D x 21½"H 60"W x 20"D x 21½"H | HLSL2072S4 | 190 | 21.9 | \$1792 | \$40 | \$40 |
| | NOTES: Unit is locking. | HLSL2060S4 | 160 | 18.9 | \$1540 | \$35 | \$40 |

NOTES:

- Worksurfaces with 7" O-legs, may be placed upon low credenzas to create layering.
- Chassis and drawer fronts woodgrains and solid laminates are specified separately (see SIF options below).
- File drawers accept hanging folders in letter size.
- Multiple handle locations possible per customer preference.
- Seat cushions are available for low credenzas and mobile pedestals (specify separately).
- Storage accessory model HLSLDRWORG works with box doors.
- Layering shelf works with low credenzas to provide additional storage areas.
- File, lateral, and wide box drawers operate on ball-bearing suspension with full extension.
- Adjustable hex leveling glides allow floor-standing furniture to be easily leveled without lifting the unit; glides have 1/4" adjustable range.
- Ships with one handle per drawer on all units.

 Locking units equipped with HON "One Key" interchangeable core removable locks. Keyed alike core must be ordered separately.

HOW TO SPECIFY

| | | | |
|---|---|--|---|
| Select Model Number HLSL2072LD4 | Select Chassis Laminate See page 183 N | Select Drawer Front Laminate See page 183 N | Select Pull Color See page 183 Not specified for Open Credenza models HLSL2072LDO, HLSL2060LDO T4 |
|---|---|--|---|

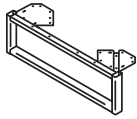

DESCRIPTION

7" O-Leg Support for Worksurfaces

30"D x 7"H

24"D x 7"H

20"D x 7"H

Specify: Model.Paint HL3070.T1.

NOTES: 7" O-Leg Support to be placed upon Low Credenza models to support worksurfaces. Ship 1/pack.

| MODEL | SHIP WEIGHT | CUBE | LIST PRICE BY PAINT GRADE | | |
|-----------------|-------------|------|---------------------------|-------|-------|
| | | | P1 | P2 | P3 |
| HL3070 ☺ | 7 | 1.0 | \$305 | \$309 | \$325 |
| HL2470 | 6 | 1.0 | \$240 | \$244 | \$260 |
| HL2070 | 5 | 1.0 | \$222 | \$226 | \$242 |

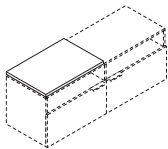

DESCRIPTION

Credenza Cushion

20"W x 36"D x 1"H for 72" Credenzas

20"W x 30"D x 1"H for 60" Credenzas

NOTES: See pages 22-24 for available fabrics.

COM: .75

SPECIFYING EXAMPLE: HL2036CH2.APN23

| MODEL | SHIP WEIGHT | CUBE | LIST PRICE BY FABRIC GRADE | | | | | |
|------------------|-------------|------|----------------------------|-------|-------|-------|-------|-------|
| | | | 1 | 2 | 3 | 4 | 5 | 6 |
| HL2036CH2 | 11 | 2.2 | \$451 | \$489 | \$527 | \$566 | \$615 | \$665 |
| HL2030CH2 | 9 | 1.9 | \$418 | \$454 | \$490 | \$526 | \$572 | \$619 |

NOTES:

- Worksurfaces with 7" O-legs, may be placed upon low credenzas to create layering.
- Chassis and drawer fronts woodgrains and solid laminates are specified separately (see SIF options on preceding page).
- Seat cushions are available for low credenzas and mobile pedestals (specify separately).
- Storage accessory model HL3DRWORG works with box doors.
- Layering shelf works with low credenzas to provide additional storage areas.
- File, lateral, and wide box drawers operate on ball-bearing suspension with full extension.
- Adjustable hex leveling glides allow floor-standing furniture to be easily leveled without lifting the unit; glides have 1/4" adjustable range.
- Ships with one handle per drawer on all units.

HOW TO SPECIFY

| | |
|----------------------------|---------------------------|
| Select Model Number | Select Paint Color |
| HL3070. | See page 183 |
| T1 | |

Laminate Low Footed Credenzas

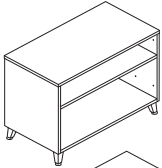
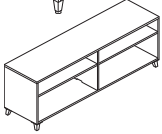
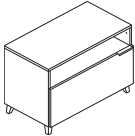
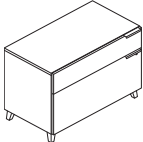
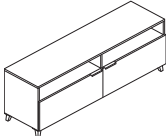
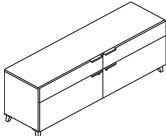
| | DESCRIPTION | MODEL | SHIP WEIGHT | CUBE | L1 LIST | L2 UPCHARGES | |
|--|---|-----------------------|-------------|------|---------------|--------------|-------------|
| | | | | | | CHASSIS | FRONTS |
|  | Low Credenza, Open, Footed | | | | | | |
| | 30"W x 20"D x 24½"H | HLSL2030LD0F Ⓢ | 67 | 9.8 | \$1036 | \$25 | N/A |
| | 36"W x 20"D x 24½"H | HLSL2036LD0F | 87 | 11.9 | \$1066 | \$30 | N/A |
| | 60"W x 20"D x 24½"H | HLSL2060LD0F | 132 | 19.9 | \$1254 | \$35 | N/A |
|  | 72"W x 20"D x 24½"H | HLSL2072LD0F | 172 | 23.7 | \$1495 | \$40 | N/A |
|  | Low Credenza, 1 File/Open, Footed | | | | | | |
| | 30"W x 20"D x 24½"H | HLSL2030LD1F | 77 | 9.8 | \$1144 | \$25 | \$15 |
| | 36"W x 20"D x 24½"H | HLSL2036LD1F | 97 | 11.9 | \$1177 | \$30 | \$15 |
|  | Low Credenza, 1 File/1 Box, Footed | | | | | | |
| | 30"W x 20"D x 24½"H | HLSL2030LD2F | 82 | 9.8 | \$1265 | \$25 | \$20 |
| | 36"W x 20"D x 24½"H | HLSL2036LD2F | 102 | 11.9 | \$1300 | \$30 | \$20 |
|  | Low Credenza, 2 File/Open, Footed | | | | | | |
| | 60"W x 20"D x 24½"H | HLSL2060LD2F | 162 | 19.9 | \$1617 | \$35 | \$30 |
| | 72"W x 20"D x 24½"H | HLSL2072LD2F | 202 | 23.7 | \$1762 | \$40 | \$30 |
|  | Low Credenza, 2 File/2 Box, Footed | | | | | | |
| | 60"W x 20"D x 24½"H | HLSL2060LD4F | 192 | 19.9 | \$1721 | \$35 | \$40 |
| | 72"W x 20"D x 24½"H | HLSL2072LD4F | 232 | 23.7 | \$1880 | \$40 | \$40 |

NOTES:

- Worksurfaces with 4" stanchions may be placed upon low credenzas to create layering.
- Chassis and drawer fronts woodgrains and solid laminates are specified separately (see SIF options below).
- File drawers accept hanging folders in letter size.
- Multiple handle locations possible per customer preference.
- Seat cushions are available for low credenzas (specify separately).
- Storage accessory model HLSLDRWORG works with box drawers.
- Layering shelf works with low credenzas to provide additional storage areas.
- File, lateral, and wide box drawers operate on ball-bearing suspension with full extension.
- Adjustable hex leveling glides allow floor-standing furniture to be easily leveled without lifting the unit; glides have 1/4" adjustable range.
- Ships with one handle per drawer on all units.

ⓘ Locking units equipped with HON "One Key" interchangeable core removable locks. Keyed alike core must be ordered separately.

ⓘ 7" O-legs cannot be used as a support on footed credenzas.

HOW TO SPECIFY

| | | | | |
|----------------------------|--------------------------------|-------------------------------------|--|--------------------------|
| Select Model Number | Select Chassis Laminate | Select Drawer Front Laminate | Select Pull Color | Select Foot Color |
| See page 183 | See page 183 | See page 183 | See page 183 Not specified for Open Credenza models | See page 183 |
| HLSL2030LD0F | C | C | T1 | T1 |

Laminate Low Footed Credenzas

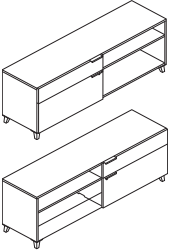
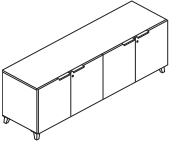
| | DESCRIPTION | MODEL | SHIP WEIGHT | CUBE | L1 LIST | L2 UPCHARGES | |
|---|--|---------------------|-------------|------|---------------|--------------|-------------|
| | | | | | | CHASSIS | FRONTS |
|  | Low Credenza, Box/File, Open, Footed | | | | | | |
| | 60"W x 20"D x 24½"H — Left Hand Drawers | HLSL2060LL2F | 162 | 19.9 | \$1487 | \$35 | \$20 |
| | 72"W x 20"D x 24½"H — Left Hand Drawers | HLSL2072LL2F | 202 | 23.7 | \$1746 | \$40 | \$20 |
| | 60"W x 20"D x 24½"H — Right Hand Drawers | HLSL2060LR2F | 162 | 19.9 | \$1487 | \$40 | \$20 |
| | 72"W x 20"D x 24½"H — Right Hand Drawers | HLSL2072LR2F | 202 | 23.7 | \$1746 | \$40 | \$20 |
|  | Low Credenza, 4 Storage Doors, Footed | | | | | | |
| | 60"W x 20"D x 24½"H | HLSL2060S4F | 162 | 19.9 | \$1614 | \$35 | \$40 |
| | 72"W x 20"D x 24½"H | HLSL2072S4F | 192 | 23.7 | \$1866 | \$40 | \$40 |

NOTES:

- Worksurfaces with 4" stanchions may be placed upon low credenzas to create layering.
- Chassis and drawer fronts woodgrains and solid laminates are specified separately (see SIF options below).
- File drawers accept hanging folders in letter size.
- Multiple handle locations possible per customer preference.
- Seat cushions are available for low credenzas and mobile pedestals (specify separately).
- Storage accessory model HLSLDRWORG works with box doors.
- Layering shelf works with low credenzas to provide additional storage areas.
- File, lateral, and wide box drawers operate on ball-bearing suspension with full extension.
- Adjustable hex leveling glides allow floor-standing furniture to be easily leveled without lifting the unit; glides have 1/4" adjustable range.
- Ships with one handle per drawer on all units.

❗ HLSL2060S4F and HLSL2072S4F require model HF27 lock cores.

❗ Locking units equipped with HON "One Key" interchangeable core removable locks. Keyed alike core must be ordered separately.

❗ 7" O-legs cannot be used as a support on footed credenzas.

HOW TO SPECIFY



| | | | | |
|----------------------------|--|---|--|--|
| Select Model Number | Select Chassis Laminate See page 183 | Select Drawer Front Laminate See page 183 | Select Pull Color See page 183 Not specified for Open Credenza models | Select Foot Color See page 183 |
| HLSL2060LL2F | C | C | T1 | T1 |

VOI® Laminate Credenzas

GSA SIN 33721

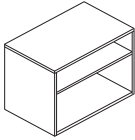

Icon Legend on page 19

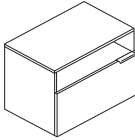
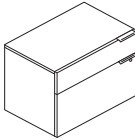
| | DESCRIPTION | MODEL | SHIP WEIGHT | CUBE | L1 LIST | L2 UPCHARGES | |
|--|---|--|-------------|-------------|--------------------------------|----------------------------|----------------------------|
| | | | | | | CHASSIS | FRONTS |
|  | Low Credenza — Open | | | | | | |
| | 30"W x 20"D x 21½"H 36"W x 20"D x 21½"H | HLSL2030LDO  HLSL2036LDO | 65 85 | 9.8 12.0 | \$977 \$1006 | \$25 \$30 | N/A N/A |
|  | Low Credenza — Open Top, File Drawer | | | | | | |
| | 30"W x 20"D x 21½"H 36"W x 20"D x 21½"H NOTES: Unit is non-locking. | HLSL2030LD1 HLSL2036LD1 | 75 95 | 9.8 12.0 | \$1085 \$1118 | \$25 \$30 | \$15 \$15 |
|  | Low Credenza — 1 File Drawer, 1 Box Drawer | | | | | | |
| | 30"W x 20"D x 21½"H 36"W x 20"D x 21½"H NOTES: Unit is locking. | HLSL2030LD2 HLSL2036LD2 | 80 100 | 9.8 12.0 | \$1206 \$1241 | \$25 \$30 | \$20 \$20 |

NOTES:

- Worksurfaces with 7" O-legs, may be placed upon low credenzas to create layering.
- File drawers accept hanging folders in letter size.
- Multiple handle locations possible per customer preference.
- Post legs on Shared Overhead are compatible to attach to low credenzas.
- Storage accessory model HLSLDRWORG works with box doors.
- File, lateral, and wide box drawers operate on ball-bearing suspension with full extension.
- Utilize in small footprint applications.
- Adjustable hex leveling glides allow floor-standing furniture to be easily leveled without lifting the unit; glides have 1/4" adjustable range.
- Ships with one handle per drawer on all units.

 Locking units equipped with HON "One Key" interchangeable core removable locks. Keyed alike core must be ordered separately.

HOW TO SPECIFY**Select Model Number**

HLSL2030LDO

Select Chassis Laminate

See page 183

N

Select Drawer Front Laminate

See page 183

Not specified for Open Credenza models HLSL2030LDO, HLSL2036LDO

N

Select Pull Color

See page 183

Not specified for Open Credenza models HLSL2030LDO, HLSL2036LDO

T4

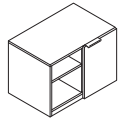

VOI® Laminate Mobile Storage

**DESCRIPTION**

Mobile Credenza
30"W x 20"D x 21½"H

NOTES: Unit is non-locking.

| MODEL | SHIP WEIGHT | CUBE | L1 LIST | L2 UPCHARGES | |
|-------------|-------------|------|---------|--------------|--------|
| | | | | CHASSIS | FRONTS |
| HLSL2030MCO | 80 | 9.8 | \$1566 | \$25 | \$10 |

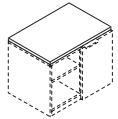
**DESCRIPTION**

Credenza Cushion
20"W x 30"D x 1"H for 60" Credenzas

NOTES: See pages 22-24 for available fabrics.

COM: .75

SPECIFYING EXAMPLE: HLSL2030CH2.APN23

| MODEL | SHIP WEIGHT | CUBE | LIST PRICE BY FABRIC GRADE | | | | | |
|-------------|-------------|------|----------------------------|-------|-------|-------|-------|-------|
| | | | 1 | 2 | 3 | 4 | 5 | 6 |
| HLSL2030CH2 | 9 | 1.9 | \$418 | \$454 | \$490 | \$526 | \$572 | \$619 |

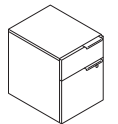
**DESCRIPTION**

Mobile Pedestal
15¾"W x 20½"D x 21¾"H

NOTES: Unit is locking.

| MODEL | SHIP WEIGHT | CUBE | L1 LIST | L2 UPCHARGES | |
|-------------|-------------|------|---------|--------------|--------|
| | | | | CHASSIS | FRONTS |
| HLSL2016MP2 | 65 | 5.7 | \$893 | \$20 | \$10 |

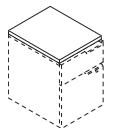
**DESCRIPTION**

Mobile Pedestal Cushion
15¾"W x 20"D x 1"H for Pedestals

NOTES: See pages 22-24 for available fabrics.

SPECIFYING EXAMPLE: HLSL2016PH2.APN23

| MODEL | SHIP WEIGHT | CUBE | LIST PRICE BY FABRIC GRADE | | | | | |
|-------------|-------------|------|----------------------------|-------|-------|-------|-------|-------|
| | | | 1 | 2 | 3 | 4 | 5 | 6 |
| HLSL2016PH2 | 6 | 1.1 | \$347 | \$371 | \$395 | \$419 | \$450 | \$481 |

**NOTES:**

- Chassis and drawer fronts woodgrains and solid laminates are specified separately (see SIF options below).
- File drawers accept hanging folders in letter or legal size.
- Multiple handle locations possible per customer preference.
- Seat cushions are available for low credenzas, floor credenzas, and mobile pedestals (specify separately).
- Storage accessory model HLSLDRWORG works with box doors.
- Standard box drawers operate on ball-bearing suspension with 70% extension. File drawers operate on ball-bearing suspension with 70% extension.
- Ships with one handle per drawer on all units.

! Locking units equipped with HON "One Key" interchangeable core removable locks. Keyed alike core must be ordered separately.

HOW TO SPECIFY

| | | | |
|---|---|--|--|
| Select Model Number HLSL2030MCO | Select Chassis Laminate See page 183 N | Select Drawer Front Laminate See page 183 N | Select Pull Color See page 183 T4 |
|---|---|--|--|

VOI® Laminate Storage

GSA SIN 33721

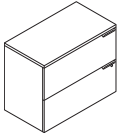
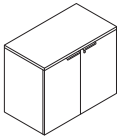
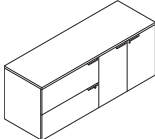
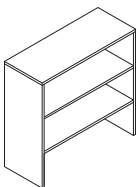

Icon Legend on page 19

| | DESCRIPTION | MODEL | SHIP WEIGHT | CUBE | L1 LIST | L2 UPCHARGES | |
|--|--|-----------------|-------------|------|---------------|--------------|-------------|
| | | | | | | CHASSIS | FRONTS |
|  | 2-Drawer Lateral Files 36"W x 24"D x 29½"H | HL2436L2 | 305 | 29.8 | \$1438 | \$35 | \$20 |
| | 36"W x 20"D x 29½"H | HL2036L2 | 170 | 15.7 | \$1291 | \$30 | \$20 |
|  | 4-Drawer Lateral Files 36"W x 24"D x 57"H | HL2436L4 | 366 | 35.9 | \$2045 | \$45 | \$30 |
| | 36"W x 20"D x 57"H | HL2036L4 | 204 | 18.3 | \$1921 | \$40 | \$30 |
|  | Storage Cabinet 36"W x 24"D x 29½"H | HL2436SC | 150 | 18.3 | \$1089 | \$35 | \$20 |
| | 36"W x 20"D x 29½"H | HL2036SC | 147 | 15.7 | \$1023 | \$30 | \$20 |
|  | Lateral/Storage Cabinet Credenza 72"W x 24"D x 29½"H | HL2472LC | 300 | 35.6 | \$2899 | \$45 | \$30 |
|  | Bookcase Hutch (no doors) 36"W x 14"D x 35"H | HL1436BH | 125 | 3.7 | \$787 | \$20 | N/A |
| | NOTES: Bookcase Hutch model works with Storage Cabinet and Lateral File models shown above. <ul style="list-style-type: none"> ⓘ Specify: Chassis laminate only. ⓘ Top two shelves have 12" spacing to allow for binder storage and bottom shelf has 8¼" spacing. | | | | | | |

NOTES:

- Ships with one handle per drawer on all units.
 - All models shown below are locking.
 - Chassis and drawer fronts woodgrains and solid laminates are specified separately (see SIF options below).
 - File drawers accept hanging folders in letter or legal size.
 - Multiple handle locations possible per customer preference.
 - Adjustable hex leveling glides allow floor-standing furniture to be easily leveled without lifting the unit; glides have 1/4" adjustable range.
- ⓘ Locking units equipped with HON "One Key" interchangeable core removable locks. Keyed alike core must be ordered separately.

HOW TO SPECIFY

| | | | |
|--|--|---|---|
| Select Model Number <div style="border: 1px solid #ccc; padding: 2px; display: flex; gap: 5px;"> HLSL2036L2 </div> | Select Chassis Laminate See page 183 <div style="border: 1px solid #ccc; padding: 2px; display: flex; gap: 5px;"> N </div> | Select Drawer Front Laminate See page 183 Not specified for model HL2436BH <div style="border: 1px solid #ccc; padding: 2px; display: flex; gap: 5px;"> N </div> | Select Pull Color See page 183 Not specified for Bookcase Hutch model HL2436BH <div style="border: 1px solid #ccc; padding: 2px; display: flex; gap: 5px;"> T4 </div> |
|--|--|---|---|



Icon Legend on page 19

Laminate Storage Cubes

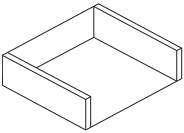
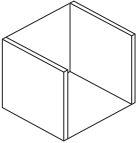
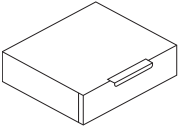
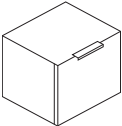
| | DESCRIPTION | MODEL | SHIP WEIGHT | CUBE | L1 LIST | L2/P2 UPCHARGES | | |
|---|--|----------------------|-------------|------|---------|-----------------|------------|-------|
| | | | | | | CHASSIS | DOOR FRONT | PAINT |
|  | Short Open Cube 15"W x 13"D x 4"H | HLSL154LSO | 9 | 1.4 | \$163 | \$10 | N/A | \$8 |
|  | Tall Open Cube 15"W x 13"D x 12"H | HLSL1512LSO | 16 | 2.9 | \$194 | \$10 | N/A | \$8 |
|  | Drawer Cube 15"W x 13"D x 4"H | HLSL154LSD | 19 | 1.4 | \$243 | \$10 | \$5 | \$8 |
|  | Cabinet Cube 15"W x 13"D x 12"H – Right Handed | HLSL1512LSCR | 24 | 2.9 | \$243 | \$10 | \$5 | \$8 |
| | 15"W x 13"D x 12"H – Left Handed | HLSL1512LSCCL | 24 | 2.9 | \$243 | \$10 | \$5 | \$8 |

NOTES:

- 4"H and 12"H cubes attach to credenzas, worksurfaces, or wall mounted shelves.
- Configurable components are assembled using double-sided tape.
- Three 4"H cubes can be stacked to the height of one 12"H cube.
- ⓘ Do not leave a gap wider than 15" between cubes while assembled with a shelf.
- ⓘ Do not stack cube and shelf configurations higher than 30".
- ⓘ Do not span cubes across worksurface-to-credenza applications.

HOW TO SPECIFY

| | | | | |
|---|--|---|--|--|
| <p>Select Model Number</p> <p>HLSL154LSD</p> | <p>Select Chassis Laminate</p> <p>See page 183</p> <p>C</p> | <p>Select Front Laminate</p> <p>See page 183</p> <p>Not specified on HLSL154LSO and HLSL1512LSO</p> <p>C</p> | <p>Select Paint Color</p> <p>See page 183</p> <p>P3 upcharge (+ \$20)</p> <p>T1</p> | <p>Select Pull Color</p> <p>See page 183</p> <p>Not specified on HLSL154LSO and HLSL1512LSO</p> <p>T1</p> |
|---|--|---|--|--|

| | DESCRIPTION | MODEL | SHIP WEIGHT | CUBE | L1 LIST PRICE | L2 UPCHARGE |
|---|-------------------------------|------------------|-------------|------|---------------|-------------|
|  | Shelves 30"W x 13"D | HLSLR1330 | 10 | 1.3 | \$210 | \$10 |
| | 36"W x 13"D | HLSLR1336 | 12 | 1.5 | \$236 | \$10 |
| | 45"W x 13"D | HLSLR1345 | 15 | 1.9 | \$256 | \$10 |

NOTES:

- Use shelves in between cubes to create another layering element, if desired.

HOW TO SPECIFY

| | |
|--|--|
| <p>Select Model Number</p> <p>HLSLR1330</p> | <p>Select Laminate</p> <p>See page 183</p> <p>C</p> |
|--|--|

VOI® Laminate Storage Cube Bundles

| QTY | DESCRIPTION | MODEL | LIST PRICE | PRICE EXTENSION |
|-------------------|---|------------|---------------|-----------------|
| 2 | Cube Bundle A Short Open Cube 15"W x 13"D x 4"H | HLSL154LSO | \$163 | \$326 |
| HLSL15-SOO | | | TOTAL: | \$326 |

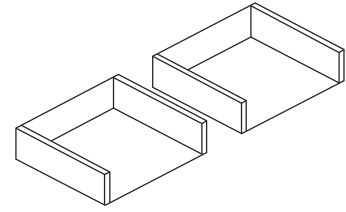

HLSL15-SOO

| QTY | DESCRIPTION | MODEL | LIST PRICE | PRICE EXTENSION |
|---------------------|---|-------------|---------------|-----------------|
| 3 | Cube Bundle B Short Open Cube 15"W x 13"D x 4"H | HLSL154LSO | \$163 | \$489 |
| 1 | Tall Open Cube 15"W x 13"D x 12"H | HLSL1512LSO | \$194 | \$194 |
| HLSL15-SOOLO | | | TOTAL: | \$683 |

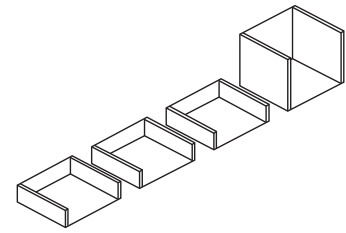

HLSL15-SOOLO

| QTY | DESCRIPTION | MODEL | LIST PRICE | PRICE EXTENSION |
|----------------------|---|--------------|---------------|-----------------|
| 1 | Cube Bundle C Short Open Cube 15"W x 13"D x 4"H | HLSL154LSO | \$163 | \$163 |
| 1 | Tall Open Cube 15"W x 13"D x 12"H | HLSL1512LSO | \$194 | \$194 |
| 1 | Drawer Cube 15"W x 13"D x 4"H | HLSL154LSD | \$243 | \$243 |
| 1 | Cabinet Cube, Right Handed 15"W x 13"D x 12"H | HLSL1512LSCR | \$243 | \$243 |
| HLSL15-SODLOC | | | TOTAL: | \$843 |

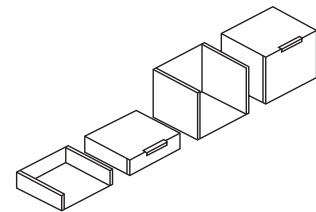

HLSL15-SODLOC

| QTY | DESCRIPTION | MODEL | LIST PRICE | PRICE EXTENSION |
|----------------------|---|--------------|---------------|-----------------|
| 2 | Cube Bundle D Drawer Cube 15"W x 13"D x 4"H | HLSL154LSD | \$243 | \$486 |
| 2 | Cabinet Cube, Right Handed 15"W x 13"D x 12"H | HLSL1512LSCR | \$243 | \$486 |
| HLSL15-SDDLCC | | | TOTAL: | \$972 |

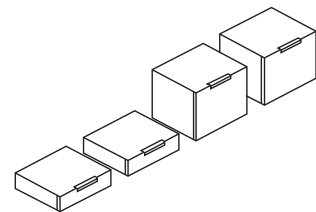

HLSL15-SDDLCC

| QTY | DESCRIPTION | MODEL | LIST PRICE | PRICE EXTENSION |
|------------------------|---|--------------|---------------|-----------------|
| 2 | Cube Bundle E Drawer Cube 15"W x 13"D x 4"H | HLSL154LSD | \$243 | \$486 |
| 2 | Short Open Cube 15"W x 13"D x 4"H | HLSL154LSO | \$163 | \$326 |
| 1 | Tall Open Cube 15"W x 13"D x 12"H | HLSL1512LSO | \$194 | \$194 |
| 1 | Cabinet Cube, Right Handed 15"W x 13"D x 12"H | HLSL1512LSCR | \$243 | \$243 |
| HLSL15-SOODDLOC | | | TOTAL: | \$1,249 |

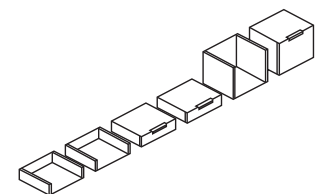

HLSL15-SOODDLOC



| | DESCRIPTION | MODEL | SHIP WEIGHT | CUBE | L1 LIST | L2 UPCHARGES | |
|--|---|-------------------|-------------|------|---------------|--------------|--------------|
| | | | | | | CHASSIS | FRONTS |
| | 24\"/> | | | | | | |
| | 24\"/> | HLSLW045L | 167 | 17.4 | \$2159 | \$50 | \$35 |
| | 24\"/> | HLSLW046L | 200 | 22.5 | \$2449 | \$55 | \$35 |
| | 24\"/> | | | | | | |
| | 24\"/> | HLSLW045R | 167 | 17.4 | \$2159 | \$50 | \$35 |
| | 24\"/> | HLSLW046R | 200 | 22.5 | \$2449 | \$55 | \$35 |
| | 24\"/> | | | | | | |
| | 24\"/> | HLSLW445L | 200 | 20.7 | \$2339 | \$55 | \$35 |
| | 24\"/> | HLSLW446L | 240 | 27.8 | \$2578 | \$60 | \$35 |
| | 24\"/> | | | | | | |
| | 24\"/> | HLSLW445R | 200 | 20.7 | \$2339 | \$55 | \$35 |
| | 24\"/> | HLSLW446R | 240 | 27.8 | \$2578 | \$60 | \$35 |
| | 24\"/> | | | | | | |
| | 24\"/> | HLSLW446LP | 250 | 27.8 | \$2920 | \$60 | \$35 |
| | 24\"/> | HLSLW446RP | 250 | 27.8 | \$2920 | \$60 | \$35 |
| | | | | | | | |
| | Worksurface to Tower Bracket Kit | | | | | | |
| | Bracket to attach storage towers or pedestal to worksurfaces. | HSTB2W1 | 4 | 0.6 | \$88 | \$101 | \$103 |
| | NOTES: Can be used in place of end panel or O-leg to support worksurfaces. | | | | | | |
| | ! Bracket cannot be used as a support when placing Stack-on Storage on worksurface over bracket. Must use two full-sized supports when using Stack-on Storage. | | | | | | |

NOTES:

- Use the worksurface to tower bracket kit to attach worksurfaces to Storage Towers models shown above.
- Chassis and drawer fronts woodgrains and solid laminates are specified separately (see SIF options below).
- File drawers accept hanging folders in letter or legal size.
- Wardrobe, middle box drawer and file drawer are locking.
- Standard box drawers operate on ball-bearing suspension with full extension. File, lateral, and wide box drawers operate on ball-bearing suspension with full extension.
- Ships with one handle per drawer on all units.
- Adjustable hex leveling glides allow floor-standing furniture to be easily leveled without lifting the unit; glides have 1/4" adjustable range.
- Wardrobe/storage cabinet includes coat rod.
- Wardrobes contain easy access side storage shelves.

! Locking units equipped with HON "One Key" interchangeable core removable locks. Keyed alike core must be ordered separately.

HOW TO SPECIFY

| | | | |
|--|---|--|--|
| Select Model Number HL SLW045L | Select Chassis Laminate See page 183 N | Select Drawer Front Laminate See page 183 N | Select Pull Color See page 183 T4 |
|--|---|--|--|

VOI® Laminate Storage Towers

GSA SIN 33721



Icon Legend on page 19

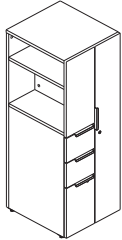

| DESCRIPTION | MODEL | SHIP WEIGHT | CUBE | L1 LIST | L2 UPCHARGES | |
|--|------------------|-------------|------|---------------|--------------|-------------|
| | | | | | CHASSIS | FRONTS |
| 18''W x 20''D Storage Towers — Right Hand Drawers, Left Hand Door | | | | | | |
| 18''W x 20''D x 50''H, Left | HLSLW085L | 139 | 13.4 | \$1943 | \$45 | \$35 |
| 18''W x 20''D x 65''H, Left | HLSLW086L | 167 | 17.3 | \$2208 | \$50 | \$35 |
| 18''W x 20''D Storage Towers — Left Hand Drawers, Right Hand Door | | | | | | |
| 18''W x 20''D x 50''H, Right | HLSLW085R | 139 | 13.4 | \$1943 | \$45 | \$35 |
| 18''W x 20''D x 65''H, Right | HLSLW086R | 167 | 17.3 | \$2208 | \$50 | \$35 |

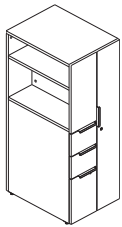

| | | | | | | |
|--|------------------|-----|------|---------------|-------------|-------------|
| 18''W x 24''D Storage Towers — Right Hand Drawers, Left Hand Door | | | | | | |
| 18''W x 24''D x 50''H, Left | HLSLW485L | 167 | 15.8 | \$2212 | \$50 | \$35 |
| 18''W x 24''D x 65''H, Left | HLSLW486L | 200 | 21.5 | \$2452 | \$55 | \$35 |
| 18''W x 24''D Storage Towers — Left Hand Drawers, Right Hand Door | | | | | | |
| 18''W x 24''D x 50''H, Right | HLSLW485R | 167 | 15.8 | \$2212 | \$50 | \$35 |
| 18''W x 24''D x 65''H, Right | HLSLW486R | 200 | 21.5 | \$2452 | \$55 | \$35 |



NOTES:

- Ships with one handle per drawer on all units.
 - Chassis and drawer fronts woodgrains and solid laminates are specified separately (see SIF options below).
 - File drawers accept hanging folders in letter or legal size.
 - Standard box drawers operate on ball-bearing suspension with full extension. File and box drawers operate on ball-bearing suspension with full extension.
 - Adjustable hex leveling glides allow floor-standing furniture to be easily leveled without lifting the unit; glides have 1/4" adjustable range.
 - Wardrobe/storage cabinet includes coat rod.
 - Wardrobes contain easy access side storage shelves.
 - Wardrobe, middle box drawer and file drawer are locking.
- ! Locking units equipped with HON "One Key" interchangeable core removable locks. Keyed alike core must be ordered separately.
- ! Worksurface-to-tower bracket cannot be used as a support when placing Stack-on Storage on worksurface over bracket. Must use two full-sized supports when using Stack-on Storage.

HOW TO SPECIFY

| | | | |
|----------------------------|--------------------------------|--|--------------------------|
| Select Model Number | Select Chassis Laminate | Select Door/Drawer Front Laminate | Select Pull Color |
| See page 183 | See page 183 | See page 183 | See page 183 |
| HL SLW085L | N | N | T4 |

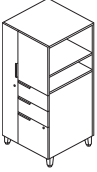
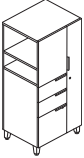
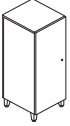
VOI® Laminate Storage Towers

| | DESCRIPTION | MODEL | SHIP WEIGHT | CUBE | L1 LIST | L2 UPCHARGES | |
|--|--|-------------------|-------------|------|---------------|--------------|-------------|
| | | | | | | CHASSIS | FRONTS |
|  | Storage Towers, Right Hand Drawers, Left Hand Doors, Footed | | | | | | |
| | 20"W x 18"D x 54"H | HLSLW085LF | 141 | 13.7 | \$2003 | \$45 | \$35 |
| | 24"W x 18"D x 54"H | HLSLW485LF | 169 | 16.2 | \$2271 | \$50 | \$35 |
| | 20"W x 24"D x 54"H | HLSLW045LF | 169 | 17.8 | \$2218 | \$50 | \$35 |
| | 24"W x 24"D x 54"H | HLSLW445LF | 202 | 21.1 | \$2398 | \$55 | \$35 |
|  | Storage Towers, Left Hand Drawers, Right Hand Doors, Footed | | | | | | |
| | 20"W x 18"D x 54"H | HLSLW085RF | 141 | 13.7 | \$2003 | \$45 | \$35 |
| | 24"W x 18"D x 54"H | HLSLW485RF | 169 | 16.2 | \$2271 | \$50 | \$35 |
| | 20"W x 24"D x 54"H | HLSLW045RF | 169 | 17.8 | \$2218 | \$50 | \$35 |
| | 24"W x 24"D x 54"H | HLSLW445RF | 202 | 21.1 | \$2398 | \$55 | \$35 |
|  | Storage Towers, One Door, Footed | | | | | | |
| | 18"W x 20"D x 46"H — Left Hand Door | HLSLW084LF | 105 | 11.3 | \$1434 | \$35 | \$25 |
| | 18"W x 20"D x 46"H — Right Hand Door | HLSLW084RF | 105 | 11.3 | \$1434 | \$35 | \$25 |
|  | Storage Towers, One Door, Non-Footed | | | | | | |
| | 18"W x 20"D x 42"H — Left Hand Door | HLSLW084L | 102 | 11.3 | \$1374 | \$35 | \$25 |
| | 18"W x 20"D x 42"H — Right Hand Door | HLSLW084R | 102 | 11.3 | \$1374 | \$35 | \$25 |

NOTES:

- Use the worksurface to tower bracket kit to attach worksurfaces to Storage Towers models shown above.
- Chassis and drawer fronts woodgrains and solid laminates are specified separately (see SIF options below).
- File drawers accept hanging folders in letter or legal size.
- Wardrobe, middle box drawer and file drawer are locking.
- Standard box drawers operate on ball-bearing suspension with full extension. File, lateral, and wide box drawers operate on ball-bearing suspension with full extension.
- Ships with one handle per drawer on all units.
- Adjustable hex leveling glides allow floor-standing furniture to be easily leveled without lifting the unit; glides have 1/4" adjustable range.
- Wardrobe/storage cabinet includes coat rod.
- Wardrobes contain easy access side storage shelves.

! Locking units equipped with HON "One Key" interchangeable core removable locks. Keyed alike core must be ordered separately.

HOW TO SPECIFY

| | | | | |
|----------------------------|--------------------------------|-------------------------------------|--------------------------|--------------------------|
| Select Model Number | Select Chassis Laminate | Select Drawer Front Laminate | Select Pull Color | Select Foot Color |
| See page 183 | See page 183 | See page 183 | See page 183 | See page 183 |
| HL SLW085LF | C | C | T1 | T1 |

VOI® Laminate Storage

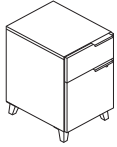

| DESCRIPTION | MODEL | SHIP WEIGHT | CUBE | L1 LIST | L2 UPCHARGES | |
|---|--------------------|-------------|------|--------------|--------------|-------------|
| | | | | | CHASSIS | FRONTS |
| Box/File Pedestal, Footed 16"W x 20"D x 28½"H | HLSL2016FP2 | 65 | 5.8 | \$952 | \$20 | \$10 |

NOTES:

- Ships with one handle per drawer on all units.
- All models shown below are locking.
- Chassis and drawer fronts woodgrains and solid laminates are specified separately (see SIF options below).
- File drawers accept hanging folders in letter or legal size.
- Multiple handle locations possible per customer preference.
- Adjustable hex leveling glides allow floor-standing furniture to be easily leveled without lifting the unit; glides have 1/4" adjustable range.

⚠ Locking units equipped with HON "One Key" interchangeable core removable locks. Keyed alike core must be ordered separately.

HOW TO SPECIFY

| | | | | |
|---|--|---|--|--|
| <p>Select Model Number</p> <p>HL S L 2 0 1 6 F P 2</p> | <p>Select Chassis Laminate</p> <p>See page 183</p> <p>C</p> | <p>Select Drawer Front Laminate</p> <p>See page 183</p> <p>C</p> | <p>Select Pull Color</p> <p>See page 183</p> <p>T 1</p> | <p>Select Foot Color</p> <p>See page 183</p> <p>T 1</p> |
|---|--|---|--|--|

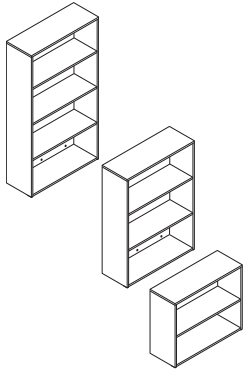

DESCRIPTION

Bookcase
 36"W x 13"D x 29½"H, 2-Shelf
 36"W x 13"D x 50"H, 3-Shelf
 36"W x 13"D x 65"H, 4-Shelf

| MODEL | SHIP WEIGHT | CUBE | LIST PRICE BY LAMINATE GRADE | |
|-------------------|-------------|------|------------------------------|--------------|
| | | | L1 | L2 |
| HLSL1336B2 | 90 | 10.7 | \$625 | \$640 |
| HLSL1336B3 | 122 | 17.3 | \$806 | \$826 |
| HLSL1336B4 | 156 | 22.2 | \$948 | \$973 |

NOTES: Bookcases available in 2, 3 and 4 shelf models. Adjustable glides allow bookcases to be easily leveled. Glides have 1/4" of adjustability.

HOW TO SPECIFY

| | |
|--|--|
| <p>Select Model Number</p> <p>H L S L 1 3 3 6 B 2 .</p> | <p>Select Laminate</p> <p>See page 183</p> <p>N</p> |
|--|--|

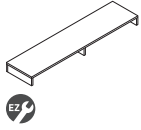

DESCRIPTION

Layering Shelf
72"W x 14½"D x 5½"H
60"W x 14½"D x 5½"H

MODEL

HLSL1472LS
HLSL1460LS

SHIP WEIGHT

50
39

CUBE

4.6
1.3

L1 LIST PRICE

\$488
\$410

L2 UPCHARGE

\$10
\$10

NOTES: Layering shelf works with lower credenzas to provide additional storage areas. For additional information see the Workplace Tools section in the 2021 Shared Spaces Pricer.

! Layering Shelves cannot be stacked.

! Cannot add a hutch on top of a layering shelf.



DESCRIPTION

Storage Cube
12"W x 12"D

MODEL

HLSL1212

SHIP WEIGHT

1.0

CUBE

0.3

LIST PRICE

\$316

SPECIFYING EXAMPLE: HLSL1212.P8S

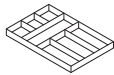

Drawer Organizer

12"W x 14½"D x 1½"H

HLSLDRWORG

1.0

0.5

\$172

NOTES: For additional information see the Workplace Tools section in the 2021 Shared Spaces Pricer.

SPECIFYING EXAMPLE: HLSLDRWORG.P8F

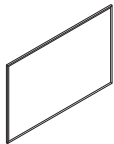

Markerboard

48"W x 31"H

HLSL4831MB

44.0

3.4

\$713

NOTES: No specification required. For additional information see the Workplace Tools section in the 2021 Shared Spaces Pricer.



OPEN MARKET

LED Task Lights

17" LED Light with Power Supply (Single)
31" LED Light with Power Supply (Single)

HLED17AS ☹️
HLED31AS ☹️

1.2 ☹️
1.5 ☹️

0.05
0.09

\$450
\$603

17" LED Light with Power Supply for Daisy-chain (Starter)
31" LED Light with Power Supply for Daisy-chain (Starter)

HLED17A
HLED31A

1.0 ☹️
1.4 ☹️

0.05
0.09

\$493
\$662

17" LED Light with 8" Jumper Cord for Daisy-chain (Follower)
31" LED Light with 8" Jumper Cord for Daisy-chain (Follower)

HLED17AUO ☹️
HLED31AUO ☹️

1.0 ☹️
1.0 ☹️

0.03
0.05

\$404
\$539

Undercabinet Occupancy Sensor with 1" End to End Connector

HLEDOSA ☹️

0.2 ☹️

0.01

\$97

NOTES: To use the daisy chain application, must start with model HLED17A or HLED31A. No finish specification required. Attaches magnetically to underside of overhead storage, or attaches with provided screws or double-sided tape. Occupancy sensor attaches to a single or starter LED light and will automatically turn the light off after no motion is detected for 30 minutes. Just like all the LED light models, the occupancy sensor features a soft-touch on/off switch. LED task lights have a lifetime of 50,000 hours and have a dimmer feature that allows the user to adjust the amount of light output.

HOW TO SPECIFY

| | |
|---|--|
| <p>Select Model Number</p> <p>H L S L 1 4 7 2 L S . N</p> | <p>Select Laminate</p> <p>See page 183</p> |
|---|--|

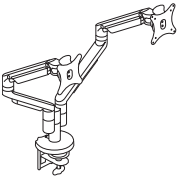
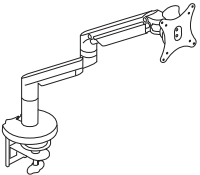
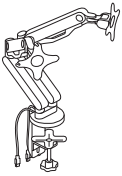
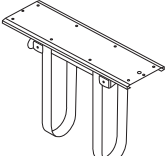

Icon Legend on page 19

| | DESCRIPTION | MODEL | SHIP WEIGHT | CUBE | LIST PRICE |
|--|---|-----------------|---------------|------|--------------|
|  | <p>Dual Dynamic Monitor Arm</p> <ul style="list-style-type: none"> • 150° of rotation at base with optional 360° rotation. • Arms extend 22" and retract up to 3". • Monitor mount rotates 180° and tilts +/-30°. • Monitor can be rotated from landscape to portrait position. <p>! Arms hold monitors from 6.2-18 lbs. Optional counterweight HPACW available to support monitors as low as 5 lbs. (see the Workplace Tools section in the 2021 Shared Spaces Pricer).</p> | HMASD | 17.0 Ⓢ | 1.1 | \$962 |
|  | <p>Single Dynamic Monitor Arm</p> <ul style="list-style-type: none"> • 180° of rotation at base with optional 360° rotation. • Arms extend 22" and retract up to 3". • Monitor mount rotates 180° and tilts +/-30°. • Monitor can be rotated from landscape to portrait position. <p>! Arms hold monitors from 6.2-18 lbs. Optional counterweight HPACW available to support monitors as low as 5 lbs. (see the Workplace Tools section in the 2021 Shared Spaces Pricer).</p> | HMASTS | 11.5 Ⓢ | 0.8 | \$501 |
|  | <p>Dual Monitor Arm with 2 USB Ports</p> <p>NOTES: Easy adjustment. Height adjusts to 17" tall. Monitor tilt and swivel capability. Enclosed cable management. Grommet or desktop mounting. Clean appearance. In some applications the Monitor Arms may extend 12 or more inches into the worksurface. For additional information see the Workplace Tools section in the 2021 Shared Spaces Pricer. HON 5-Year Limited Warranty.</p> <p>! No specification needed.</p> | HBDMAUSB | 41.9 | 2.6 | \$410 |
|  | <p>360° Swivel CPU Holder with Adjustable Straps</p> <ul style="list-style-type: none"> • Supports CPUs 3¾" wide up to 64" perimeter and holds up to 75 lbs. • 360° rotation. • Ships complete and includes necessary mounting hardware and instruction sheet. <p>! Available in Black only, no specification needed.</p> | HCPU1 | 7.0 Ⓢ | 0.2 | \$260 |

SIN 33721

NOTES:

- For additional information see the Workplace Tools section in the 2021 Shared Spaces Pricer.

Monitor Arms

- Arms fold back to post to allow more desktop room.
- Arms feature double extension, allowing 20"+ of back and forth movement.
- Cable management on both pole and arm assemblies.
- Counterbalance adjustment provides stability for monitors up to 17.6 lbs per arm.
- Made of high-quality aluminum alloy material.
- See the Workplace Tools section in the 2021 Shared Spaces Pricer for additional monitor arm models.

HOW TO SPECIFY

| | |
|-----------------------------------|--|
| <p>Select Model Number</p> | <p>Select Finish</p> <p><i>Specify for models HMASD and HMASTS only</i></p> <p>SVR Silver BLK Black</p> |
| <p>H M A S D .</p> | <p>S V R</p> |

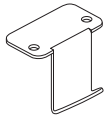

OPEN MARKET

**DESCRIPTION**

Back Pack Hook (10 per carton)
12"W x 14½"D x 1½"H

NOTES: Assembly: attaches to bottom of desk with (2) screws, included.

! Available in Platinum Metallic finish only, no specification needed.

MODEL**HCLA65****SHIP WEIGHT**

10

CUBE

0.1

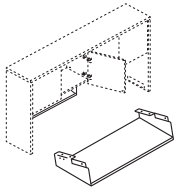
LIST PRICE**\$101****Hanging Paper Shelf**

28⅞"W x 11⅞"D x 4⅜"H

HHPS1

7

2.9

\$214

NOTES: Attaches quickly and easily (screws included). Maximizes worksurface space; de-clutters desktop while placing priority communications and active project folders within easy reach. Angled design allows contents to be distinguished at a glance. Mixed material styling features strong painted metal frame with a frosted shelf.

Attaches quickly and easily to laminate stack-on and wall mount storage models (except the 36"W Voi® overhead hutch with O-legs or panel mount brackets). Not for use with 38000 Series™ and Systems.

For additional information see the Workplace Tools section in the 2021 Shared Spaces Pricer.

Specify: Model.Paint

SPECIFYING EXAMPLE: HHPS1.T1

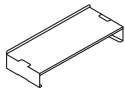
**Desktop Paper Shelf**

28⅞"W x 11⅞"D x 5"H

HDPS1

7

2.9

\$214

NOTES: Desktop Paper Shelf and Storage Terrace include protective, non-slip pads on the base. Paper Shelf can stack two-high. Organizer shelf provides a place and space for work-in-process and piling to keep work surfaces neat and tidy. Convenient, scalable design with interlocking side supports allow two units to be stacked and integrated. Durable painted metal frame with a frosted shelf; mixed material styling matches hanging paper shelf.

Can also be used inside select overhead storage, including the following stack-on with clearance and hinged door models: 10500 and Valido 36", 42", 66", 72", 78"W and 10700 68⅝"W.

For additional information see the Workplace Tools section in the 2021 Shared Spaces Pricer.

Specify: Model.Paint

SPECIFYING EXAMPLE: HDPS1.T1

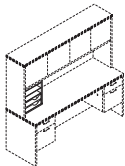

Not available in two-tone laminates

Vertical Paper Manager

14⅞"W x 10⅞"D x 19⅞"H

HLVPM1

27

2.8

\$351

NOTES: Keeps papers, files, and books neatly organized and within easy reach from a seated position. Designed for desk, credenza, and return tops. Fits under stack-on storage models. Two pullout drawers and three fixed shelves. Not available in pattern laminate colors. Ships fully assembled. For additional information see the Workplace Tools section in the 2021 Shared Spaces Pricer.

! When used in conjunction with wall mounted storage cabinets, the top of the wall mounted storage cabinets must be positioned a minimum of 68⅝" above the floor.

SPECIFYING EXAMPLE: HLVPM1.N

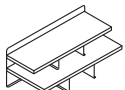

Not available in two-tone laminate

**Desktop Storage Terrace**

26½"W x 12½"D x 10½"H

HLDST1

24

1.1

\$329

NOTES: Keeps work-in-process, priority files, loose pages, and mail neatly organized and in view. Mixed material design comprised of sturdy laminate shelves with metal back and support panels. Not available in two-tone laminate combination or pattern laminate colors. Choose from Platinum Metallic (T1), Black (P), and Charcoal (S) for the metal components.

Sized to fit in stack-on and wall mounted storage cabinets in 10500, 10700, Valido, 94000, and 38000 Series. Fits in Voi stack-on and overhead cabinets except for 48"W or smaller sliding door models. For additional information see the Workplace Tools section in the 2021 Shared Spaces Pricer.

Specify: Model.Laminate.Paint





SPECIFYING EXAMPLE: HLDST1.N.T1

HOW TO SPECIFY

Select
Model Number

H C L A 6 5

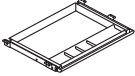

| | DESCRIPTION | MODEL | SHIP WEIGHT | CUBE | LIST PRICE |
|--|--|------------------------------|--------------|------------|------------------------------|
|  Refer to page 104 for Center Drawer compatibility information SIN 33721  | Angled Wood Center Drawer 26" x 15 ³ / ₈ " 22" x 15 ³ / ₈ " | H1526 H1522 | 12 Ⓞ 11 Ⓞ | 1.2 1.1 | \$214 \$199 |
| | NOTES: Specify laminate for drawer. Ideal for pens, pencils and other miscellaneous storage. Feature ball-bearing slide suspension. For additional information see the Workplace Tools section in the 2021 Shared Spaces Pricer. | | | | |
|  OPEN MARKET | Polymer Center Drawer <ul style="list-style-type: none"> • Color: Black. • Material: ABS. • Minimum clearance for mounting: 23"W x 16¹/₄"D x 2"H. • Retracts on 16" ball-bearing slides. • Can be used on worksurfaces with Coordinate™ Height Adjustable Bases as long as it is attached with spacer model HKBS. • Can store up to 25 lbs. ⓘ Black finish only, no specification needed. | HCD1 | 7 | 0.5 | \$126 |
|  OPEN MARKET | Keyboard Spacer <ul style="list-style-type: none"> • For use when attaching a keyboard tray to Coordinate™ and Voi® or Systems Worksurface with an external channel. • The kit includes ten cylinder spacers and ten screws. • Spacers are 3/4"W x 2¹/₈"H. • Specify one kit per keyboard tray. NOTES: For additional information see the Workplace Tools section in the 2021 Shared Spaces Pricer. | HKBS | 1 Ⓞ | 0.8 | \$100 |

HOW TO SPECIFY

Select Model Number

| | | | |
|---|---|---|---|
| H | C | D | 1 |
|---|---|---|---|

**DESCRIPTION**
Articulating Desk Lamp
Articulating Desk Lamp w/ Occupancy Sensor

- Color: Matte Silver.
- Full-range dimming from 10% to 100%.
- Designed for 50,000 hours of life.
- Occupancy sensor is built into the head of the lamp and will automatically shut the lamp off after 6 minutes of undetected movement.
- Base swivel is 180 degrees.
- Uses only 5 watts of energy.
- Light comes with a silver 9' 4" power cord.
- Base diameter is 7.5".
- 3500K Color Temperature.
- 80 Color Rendering Index.
- TAA Compliant.

MODEL**SHIP WEIGHT****CUBE****LIST PRICE****HLED1**

1.2

6.5

\$430**HLED1OC**

1.2

6.5

\$524**Task Desk Lamp**

- Color: Brushed Nickel.
- Full-range dimming from 10% to 100%.
- Designed for 50,000 hours of life.
- Lamp is 15.83" tall.
- Desk lamp does not articulate at base. The pivoting head provides custom positioning, as it can be twisted 360 degrees.
- Uses only 5 watts of energy.
- Light comes with a silver 9' 4" power cord.
- Base diameter is 6.7".
- 3500K Color Temperature.
- 80 Color Rendering Index.
- TAA Compliant.

HLED2

0.7

3.0

\$373**NOTES:**

- For additional information see the Workplace Tools section in the 2021 Shared Spaces Pricer.

HOW TO SPECIFY

Select
Model Number

H L E D 1



Icon Legend on page 19

DESCRIPTION

MODEL

SHIP WEIGHT

CUBE

LIST PRICE



Coordinate™ Portable Desktop Riser

31"D x 5"-16½"H x 35"W

HBXRISER

54

4.1

\$657

NOTES: Available in Black (BLK) or White (WHT) finish. Desktop riser dimensions (without keyboard tray): 22"D x 5"-16½"H x 35"W. Keyboard tray dimensions: 9"D x 30"W. Max loading capacity is 33 lbs for the desktop riser surface and 4 lbs for the keyboard tray. Easily transition from seated to standing positions throughout the workday. Sits atop an existing desk to create sit-to-stand functionality by raising the computer. Includes keyboard tray and surface for computer monitors. **HON 5-Year Limited Warranty.**

! Not intended for use on mobile workstations.

HOW TO SPECIFY

Select Model Number

H B X R I S E R .

Select Finish

BLK Black
WHT White

B L K

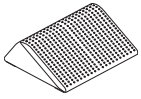

DESCRIPTION

Footrest — Anti-Slip Cover
13³/₄"D x 5¹/₂"H x 16"W

ⓘ Available in Black (T) finish ONLY. Recommended weight capacity not to exceed 250 pounds. **HON 5-Year Limited Warranty.**
SPECIFYING EXAMPLE: HVL991.T

MODEL

SHIP WEIGHT

CUBE

LIST PRICE

HVL991

7 ⓘ

0.9

\$89

HOW TO SPECIFY

Select Model Number

Select Finish

T Black



H V L 9 9 1 .

T

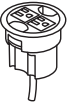
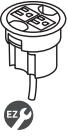

Icon Legend on page 19

Softwire Electrical Components

| | DESCRIPTION | MODEL | SHIP WEIGHT | CUBE | LIST PRICE |
|--|---|------------------|-------------|------|--------------|
|  | <p>Power Hub, 3" Grommet Mount, 6' Cord</p> <ul style="list-style-type: none"> Fits in 3" round grommet holes Field installed with Plug-and-play ease Two grounded AC power outlets Includes 6' cord with three-prong plug <p>NOTES: For additional information see the Workplace Tools section in the 2021 Shared Spaces Pricer.</p> <p>ⓘ Available in Black only. Specify X when ordering. Example: HGRMTAC.X.</p> | HGRMTAC | 1.3 | 0.2 | \$126 |
|  | <p>3" Round Power Grommet - 2 Outlets, 10' Cord</p> <ul style="list-style-type: none"> Includes 10' cord with three-prong plug. Fits in 3" round grommet holes on the following product lines: Coordinate, Huddle, Motivate, all laminate casegoods series, and Systems Worksurfaces. Two grounded AC power outlets. Field installed with Plug-and-play ease. <p>NOTES: Power Modules will also work with standing-height applications for 10500 Series™ and Voi® desks. Optional Memory Control allows preset worksurface heights for consistency. Ships separately. Dynamic load capacity when worksurface is moving is 300 lbs.</p> <p>ⓘ Available in black finish only, no specification needed.</p> | HGRMTAC2 | 1.5 | 0.2 | \$159 |
|  | <p>Power/USB Hub, 3" Grommet Mount</p> <ul style="list-style-type: none"> One grounded AC power outlet with 2 USB ports. Two cord pass-through holes in cap. Includes 6' cord with three-prong plug. Field installed; easy plug-and-play. UL Listed. <p>NOTES: For additional information see the Workplace Tools section in the 2021 Shared Spaces Pricer.</p> <p>ⓘ Available in black only (no color designation so use .X - Specify: HGRMTUSB2.X).</p> | HGRMTUSB2 | 1.3 | 0.2 | \$250 |
|  SIN 33721 | <p>Data Grommet</p> <p>Blank grommet kit that includes adapters for a variety of manufacturers jacks and couplers.</p> <ul style="list-style-type: none"> Fits in existing 3" round grommet housing <p>NOTES: For additional information see the Workplace Tools section in the 2021 Shared Spaces Pricer.</p> <p>ⓘ Available in Black only. Specify P when ordering. Example: HGRMTDATA.P.</p> | HGRMTDATA | 0.2 | 0.2 | \$23 |

HOW TO SPECIFY

Select Model Number

H G R M T A C



OPEN MARKET

DESCRIPTION**MODEL****SHIP WEIGHT****CUBE****LIST PRICE****O-Leg Cord Clips**

Clips for 28½" Worksurface O-Legs — 8-Pack

HWMCLIPLG0.8 **Ⓢ**

0.1

\$110

Clips for Stack-on Storage, Hutch and Layering O-Legs — 4-Pack

HWMCLIPSM0.5 **Ⓢ**

0.1

\$73

NOTES: Wire clips work with 7" Low Credenza O-leg and 29"H Support O-leg. Wire clips also work with the 50" and 65" Hutch O-legs. For additional information see the Workplace Tools section in the 2021 Shared Spaces Pricer.

⚠ Available in frosted plastic material only.

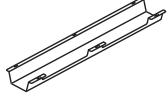
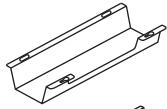
**Cable Management Troughs**

17"W — Single

HCTROUGH172.7 **Ⓢ**

0.5

\$73

17"W — 10-Pack

HCTROUGH171014.0 **Ⓢ**

0.5

\$665

36"W — Single

HCTROUGH364.9 **Ⓢ**

0.9

\$122

36"W — 10-Pack

HCTROUGH361030.0 **Ⓢ**

0.9

\$1121

- Cable management troughs ship flat packed.

- The troughs attach to underneath the worksurface with screws.

- The 17"W has one wire access cut out on the user side. The 36" has two wire access cut outs. These cut outs give users access to inside the trough without having to detach it from the worksurface.

- Color: Graphite.

- Material: Metal.

- TAA Compliant.

NOTES: For additional information see the Workplace Tools section in the 2021 Shared Spaces Pricer.

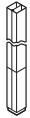
**Power Pole — w/o Receptacles**

10'5"

HH870070

14.0

0.5

\$477

⚠ Specify paint; not available in Putty (L), Platinum Metallic (T1), and Champagne Metallic (T4).

Specify paint color for
HH870070, not available in
Putty

**Field Installable Grommet****HFLDGRMT3**0.1 **Ⓢ**

0.3

\$35

- Intended for use in tops and end panels to route/hide cords and in modesty panels to facilitate reaching wall electrical outlets.

- Grommet is field installable.

- Grommet shape is round.

- Includes grommet cap and sleeve.

- Grommet outside dimensions measure 3½" diameter and includes two cord access holes.

- Grommet sleeve measures 3" O.D. x 1" thick.

- Includes instructions to locate grommet position for desks, credenzas, returns and bridges.

NOTES: For additional information see the Workplace Tools section in the 2021 Shared Spaces Pricer.

⚠ Black Finish

⚠ Requires a 3" diameter hole saw and drill for installation (not included).



⚠ Not for use with credenzas, pedestals, laterals or towers.

HOW TO SPECIFY

Select
Model Number

HWMCLIPLG

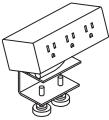
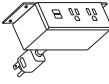
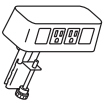
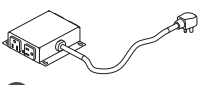

| | DESCRIPTION | MODEL | SHIP WEIGHT | CUBE | LIST PRICE |
|--|---|--------------------|-------------|------|--------------|
|  Model HPWRMOD3WC shown | Power Modules | | | | |
| | 3 Receptacles with Worksurface Clamp | HPWRMOD3WC | 2.3 Ⓢ | 0.2 | \$342 |
| | 3 Receptacles with Under-Worksurface Mounting Bracket | HPWRMOD3UWM | 2.3 Ⓢ | 0.2 | \$342 |
| | 2 Receptacles 2 USB with Worksurface Clamp | HPWRMOD2WC | 2.3 Ⓢ | 0.2 | \$546 |
|  Model HPWRMOD2UWM shown | 2 Receptacles 2 USB with Under-Worksurface Mounting Bracket | HPWRMOD2UWM | 2.3 Ⓢ | 0.2 | \$546 |
| | <ul style="list-style-type: none"> • 6' power cord with standard three-prong plug. • Under-worksurface mounting bracket models work with any top that has a 5" x 5" square clearance. • Worksurface clamp models work on any top with a 4" overhang. • UL Listed. ⓘ Color finish coordinates with HON's Charcoal or White. Specify <i>STRM</i> for Storm or <i>SNW</i> for Snow when ordering. Example: <i>HPWRMOD3WC.STRM</i> . | | | | |
|  | Power & Data Center | | | | |
| | 2 Receptacles 2 Data Accessory | HCOMDOME2 | 2.5 Ⓢ | 0.2 | \$327 |
|   | Under Worksurface Power Module — 4 Outlets, 10' Cord | HPWRMOD2 | 1.5 | 0.2 | \$441 |
| | <ul style="list-style-type: none"> • Includes 10' cord with three-prong plug. • Fits in cable management troughs. See page 242. • 4 outlets on side create easy access. NOTES: Power Modules will also work with standing-height applications for 10500 Series™ and Voi® desks. ⓘ Available in black finish only, no specification needed. | | | | |
|  | Vertebrae | HMPVWM28 | 3.0 | 0.3 | \$246 |
| | NOTES: 30"H x 3 3/8"W x 1 1/2"D. Ships unassembled. ⓘ Clear finish. Specify "X" for finish option. SPECIFYING EXAMPLE: HMPVWM28.X | | | | |

NOTES:

- For additional information see the Workplace Tools section in the 2021 Shared Spaces Pricer.

HOW TO SPECIFY

Select Model Number

H P W R M O D 3 W C

NOTES

WORKWALL

Want to see more? Scan here
to check out hon.com.



Workwall featuring Voi® Storage and Desks
and Ignition® 2.0 and Mav™ Seating.

WORKWALL

You need a solution that does it all: Encourages creative collaboration, organizes everything from photos to files, delivers exceptional functionality, and celebrates what makes your brand and the members of your team so unique. Look no further than Workwall — a brilliant tile system that mixes and matches fabric, metal, glass, and laminate materials with accessories, making it a powerhouse performer and an exemplary partner to a variety of HON products in any private office, teaming station, or meeting area. Make your space work with Workwall.



FEATURES

- High-quality materials add a remarkable aesthetic and dynamic functionality to the evolving workplace, making any private office, teaming station, or open collaboration area pop with personality and productivity.
- Tiles are offered in a variety of heights, widths, and materials, including laminate, laminate media, painted metal, slotted tool, fabric, and glass markerboard.
- Make your space an organizational oasis with Workwall's additional hanging additions — floating shelves, metal single tool rails, and a variety of painted metal accessories to keep you focused and efficient.
- Workwall can be universally paired with laminate casegoods — including HON's 10500 Series™, Concinnity™, and Voi® — or retrofitted to add on to existing workstations throughout the workspace.
- Mix-and-match tiles are designed with flexibility and adaptability in mind — create the space you want for the work environment you need.

WORKWALL ORDERING INFORMATION

LAMINATE TILES, LAMINATE MEDIA TILES, SHELVES

L1 LAMINATES/EDGE CODES

Woodgrain

- ◆ Bourbon Cherry/
Bourbon Cherry **HH**
- ◆ Cognac/Cognac ... **COGNCOGN**
- ◆ Florence Walnut/
Florence Walnut **LFW1FW**
- ◆ Harvest/Harvest **CC**
- ◆ Kingswood Walnut/
Kingswood Walnut **LK11KI**
- ◆ Mahogany/Mahogany **NN**
- ◆ Mocha/Mocha **MOCHMOCH**
- ◆ Natural Maple/
Natural Maple **DD**
- ◆ Pinnacle/Pinnacle **PINCPINC**
- ◆ Shaker Cherry/
Shaker Cherry **FF**
- ◆ Sterling Ash/
Sterling Ash **LSA1SA**

Solid

- ◆ Black/Black **PP**
- ◆ Designer White/
Designer White **LDW1DW**
- ◆ Loft/Loft **LOFTLOFT**

Patterned

- ◆ Sheer Mesh * /Muslin **A5T**
- ◆ Silver Mesh/Loft **B9LOFT**

L2 LAMINATES/EDGE CODES

Woodgrain

- ◆ Lowell Ash/Lowell Ash . **LLA1DL**
- ◆ Natural Recon/
Natural Recon **LNR1NR**
- ◆ Phantom Ecru/
Phantom Ecru **LPE1PE**
- ◆ Portico Teak/
Portico Teak **LPT1DP**
- ◆ Skyline Walnut/
Skyline Walnut **LSW1SW**

PAINTED METAL TILES, SLOTTED TOOL TILES, SINGLE TOOL RAILS, ACCESSORIES

PAINTS CODES

P1

- ◆ Black **P**
- ◆ Brownstone **P7D**
- ◆ Charcoal **S**
- ◆ Designer White **PJW**
- ◆ Fossil **P28**
- ◆ Greige **T5**
- ◆ Light Gray **Q**
- ◆ Loft **LOFT**
- ◆ Muslin **T3**
- ◆ Putty **L**
- ◆ Shadow * **SHDW**
- ◆ Titanium **P8T**

P2

- ◆ Champagne Metallic **T4**
- ◆ Platinum Metallic **T1**
- ◆ Silver **PR6**
- ◆ Solar Black **P8X**

P3

- ◆ Amethyst **P091**
- ◆ Atom **P8S**
- ◆ Blossom **P8K**
- ◆ Bullseye **PJF**
- ◆ Cabernet * **P7T**
- ◆ Cobalt Mica **P090**
- ◆ Conifer * **P8H**
- ◆ Ember **P8P**
- ◆ Ion **P8N**
- ◆ Iris **P8J**
- ◆ Krypton **P8F**
- ◆ Ochre **P093**
- ◆ Regatta **P8M**
- ◆ Sienna **P092**
- ◆ Succulent **P8A**

GLASS MARKERBOARD TILES

GLASS CODES

- ◆ Beige **GBG2**
- ◆ Charcoal **GCH2**
- ◆ Cream **GCR2**
- ◆ Ice White **GWH2**
- ◆ Pebble **GPB2**

TILE MOUNTING HARDWARE PAINT

PAINTS CODES

- ◆ Black **P**
- ◆ Charcoal **S**
- ◆ Designer White **PJW**

NOTE: For available fabrics see pages 25-26.

◆◆◆ For lead time information see page 19.

* De-emphasized

WORKWALL STATEMENT OF LINE

TILES

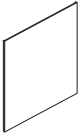

FABRIC TILE

Heights: 7½", 15", 22½", 30", 37½", 45"
Widths: 18", 24", 30", 36", 42", 48", 54", 60"

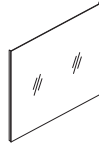

GLASS MARKERBOARD TILE

Heights: 15", 22½", 30", 37½", 45"
Widths: 30", 36", 42", 48", 54", 60"

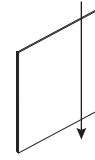

LAMINATE TILE

Grain direction shown
Heights: 7½", 15", 22½", 30", 37½", 45"
Widths: 18", 24", 30", 36"

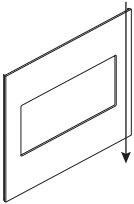

LAMINATE MEDIA TILE

Grain direction shown
Heights: 30", 37½", 45"
Widths: 36", 42", 48", 54"

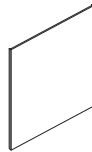

PAINTED METAL TILE

Heights: 7½", 15", 22½", 30"
Widths: 18", 24", 30", 36"

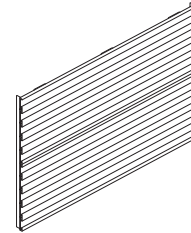

SLOTTED TOOL TILE

Heights: 7½", 15"
Widths: 24", 30", 36", 42", 48", 54", 60"

ACCESSORIES

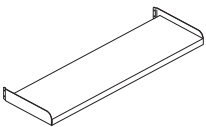

FLOATING SHELF

Widths: 18", 24", 30", 36"

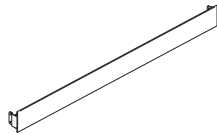

SINGLE TOOL RAIL

Widths: 18", 24", 30", 36", 42", 48", 54", 60"

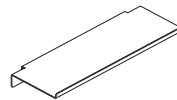

SMALL SHELF

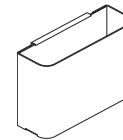

SMALL BIN

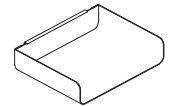

SMALL TRAY

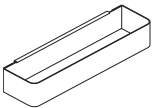

HANGING FILE FOLDER

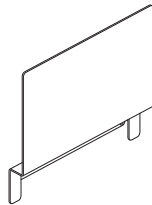

MAGNETIC PICTURE HOLDER

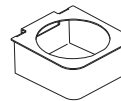

CUP

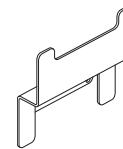

HOOK

WORKWALL SPECIFYING/DESIGN GUIDE

This Specification Guide is designed to walk you through the steps when choosing Workwall elements that will meet your particular workplace needs. The step-by-step instructions make it easy to specify elements that personalize workspaces and achieve the right mix of functionality and style.

Desking With Tower Storage (Example Shown Below)

Recommended to align Workwall tiles with tower height and work your way down the wall.

Desking Without Tower Storage

Recommended to mount Workwall tiles above worksurface and work your way up the wall.

Without Desking or Storage

Floating application can be utilized in open wall environments such as conference rooms or collaboration spaces. Any size of tiles can be used to fit your space.

STEP 1

- Specify desk.
- Please note differences in storage heights and low credenza heights.
- Standard worksurface height is 29½".
- Note the tower and overhead height differences between casegood series (see diagram on pages 249-250).

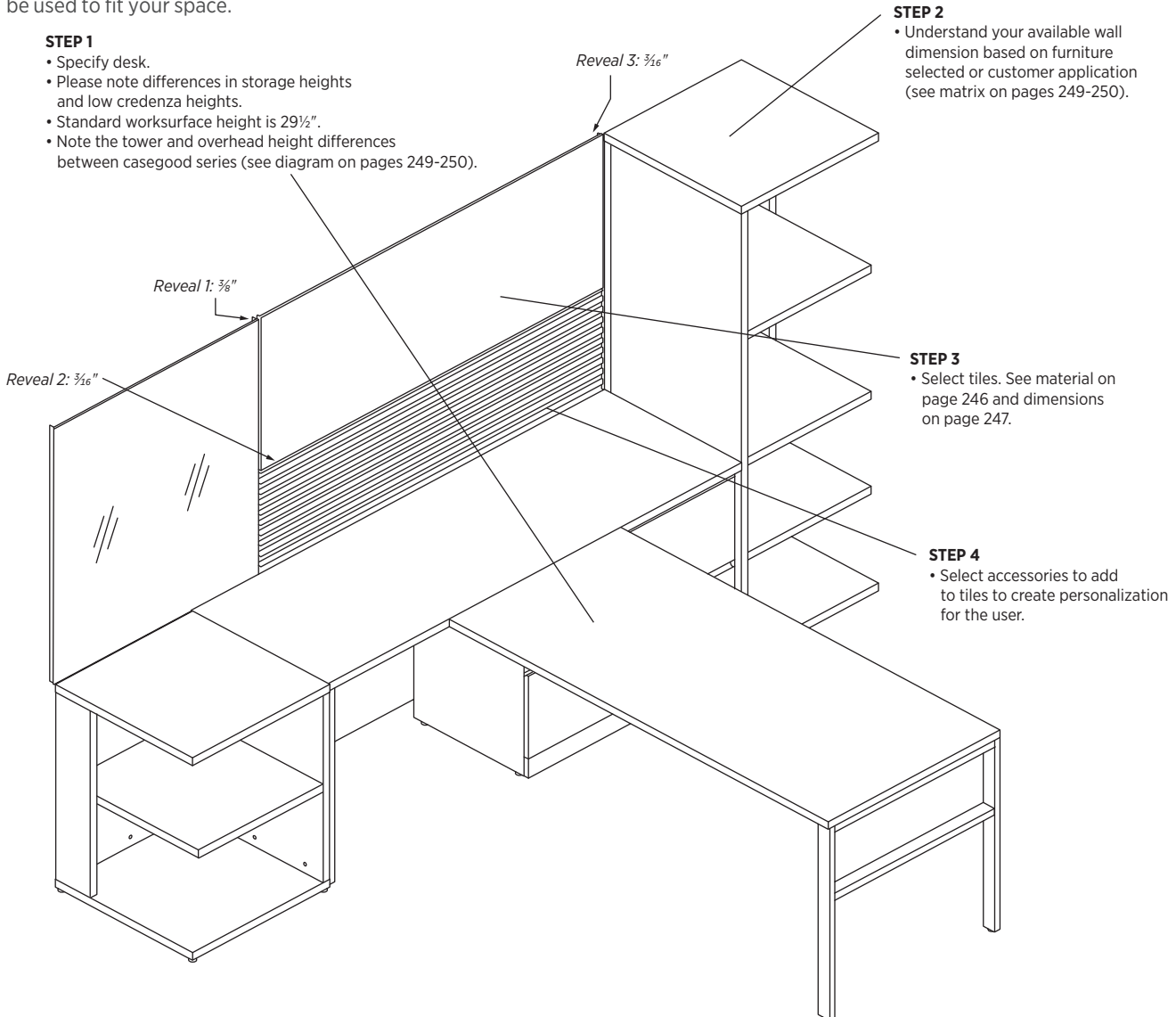

STEP 2

- Understand your available wall dimension based on furniture selected or customer application (see matrix on pages 249-250).

STEP 3

- Select tiles. See material on page 246 and dimensions on page 247.

STEP 4

- Select accessories to add to tiles to create personalization for the user.

NOTES:

- There is a 3/16" vertical reveal (Reveal 1) and a 3/16" horizontal reveal between tiles (Reveal 2). There is a 3/16" vertical reveal between towers and tiles (Reveal 3).
- Wall attachment method is Z-brackets (2 per tile).
 - i. Thickness is 7/8" from wall to front of tile (includes tile and hardware).
 - ii. Accessory Single Tool Rail + Accessories (7) + Floating Shelf add to depth dimension.
 - iii. Vertical mounting brackets come pre-installed on tile and hang on Z-brackets. Z-brackets are in two parts. The second part of the Z-bracket is attached to the wall in the field.
 - iv. Wall attachment not included due to different wall types and materials. Attachments must be provided by the installers.
- Wire management or television mounting brackets not included with tiles.

Tile Back View

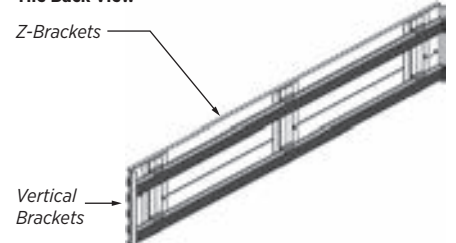

WORKWALL SPECIFYING/DESIGN GUIDE

Below are wall dimensions for Concinnity™ and 10500 Series™. These diagrams should be used to understand sizing between storage and usable wall space.

CONCINNITY™ EXAMPLE

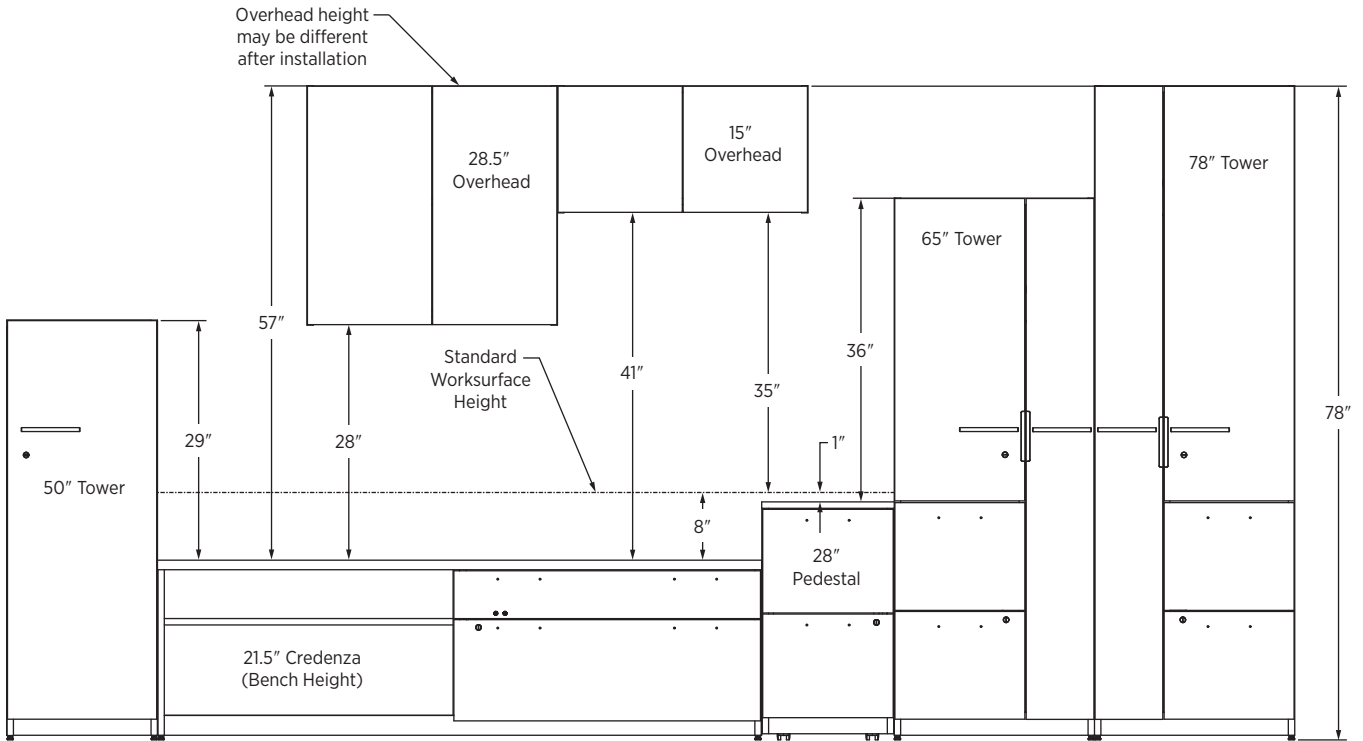

10500 SERIES™ EXAMPLE

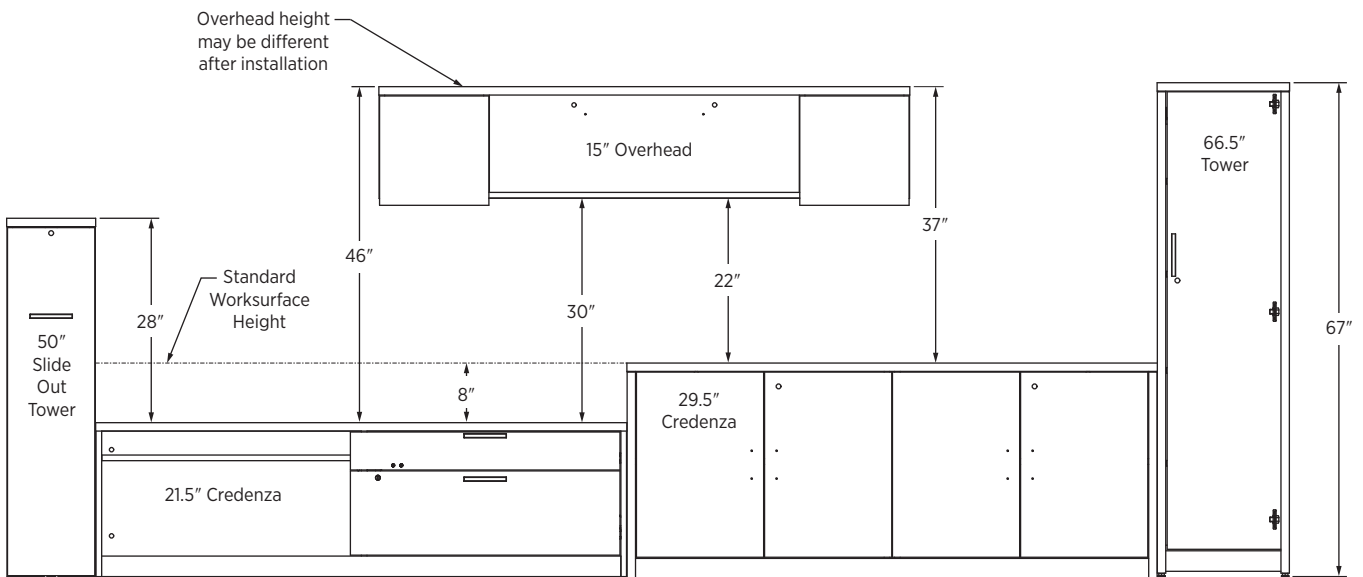

NOTES:

- Overheads can be mounted above or next to Workwall but do not mount to Workwall. Elevation shown above is typical overhead height and may vary in installation.

WORKWALL SPECIFYING/DESIGN GUIDE

Below are wall dimensions for Voi®. This diagram should be used to understand sizing between storage and usable wall space.

VOI® EXAMPLE

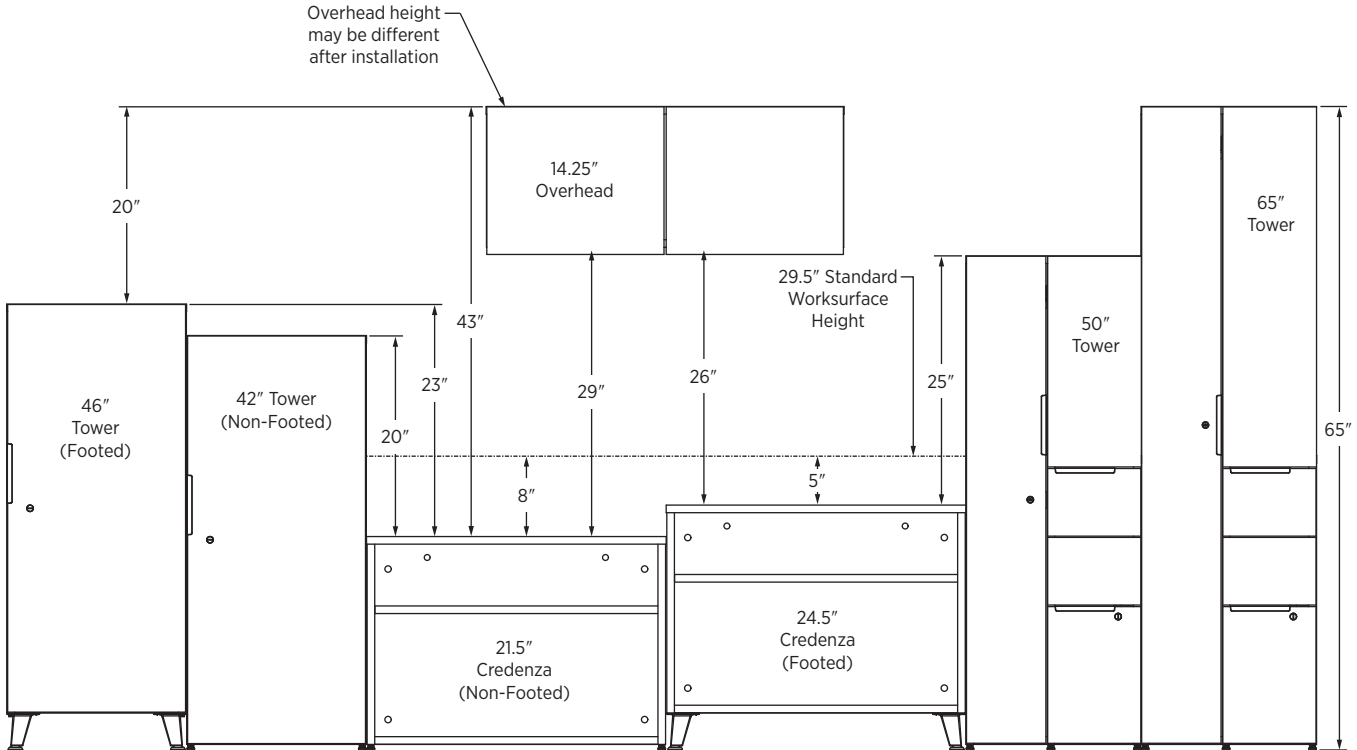

NOTES:

- ❶ Overheads can be mounted above or next to Workwall but do not mount to Workwall. Elevation shown above is typical overhead height and may vary in installation.

TILE CROSS-SECTION

Side view



Z-Bracket

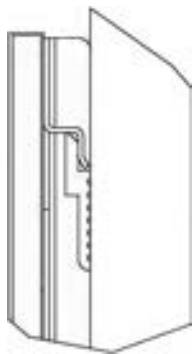

WORKWALL SPECIFYING/DESIGN GUIDE

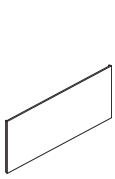

Fabric Tile

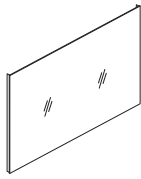

Glass Markerboard Tile

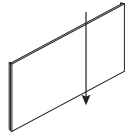

Laminate Tile

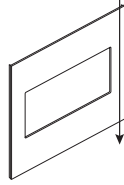

Laminate Media Tile

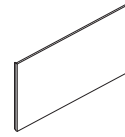

Painted Metal Tile

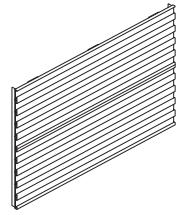

Slotted Tool Tile

Fabric Tiles

| | 18"W | 24"W | 30"W | 36"W | 42"W | 48"W | 54"W | 60"W |
|----------|------|------|------|------|------|------|------|------|
| 7 1/2"H | | | | | | | | |
| 15"H | | | | | | | | |
| 22 1/2"H | | | | | | | | |
| 30"H | | | | | | | | |
| 37 1/2"H | | | | | | | | |
| 45"H | | | | | | | | |

Glass Markerboard Tiles

| | 30"W | 36"W | 42"W | 48"W | 54"W | 60"W |
|----------|------|------|------|------|------|------|
| 15"H | | | | | | |
| 22 1/2"H | | | | | | |
| 30"H | | | | | | |
| 37 1/2"H | | | | | | |
| 45"H | | | | | | |

WORKWALL SPECIFYING/DESIGN GUIDE

Laminate Tiles

| | | | | |
|----------|------|------|------|------|
| 7 1/2"H | 18"W | 24"W | 30"W | 36"W |
| 15"H | | | | |
| 22 1/2"H | | | | |
| 30"H | | | | |
| 37 1/2"H | | | | |
| 45"H | | | | |

Laminate Media Tiles

| | | | | |
|----------|------|------|------|------|
| | 36"W | 42"W | 48"W | 54"W |
| 30"H | | | | |
| 37 1/2"H | | | | |
| 45"H | | | | |

Painted Metal Tiles

| | | | | |
|----------|------|------|------|------|
| 7 1/2"H | 18"W | 24"W | 30"W | 36"W |
| 15"H | | | | |
| 22 1/2"H | | | | |
| 30"H | | | | |

Slotted Tool Tiles

| | | | | | | | |
|---------|------|------|------|------|------|------|------|
| 7 1/2"H | 24"W | 30"W | 36"W | 42"W | 48"W | 54"W | 60"W |
| 15"H | | | | | | | |

WORKWALL Typicals

| QTY | DESCRIPTION | MODEL | LIST PRICE | PRICE EXTENSION |
|---------------|---|--------------|------------|-----------------|
| 1 | Lateral File Pedestal 36"W x 20"D x 28"H | H10503 | \$1,105 | \$1,105 |
| 1 | Credenza Shell 72"W x 24"D x 29½"H | H10541 | \$738 | \$738 |
| 1 | Square End Cap Bookshelf Left 24"W x 24"D x 29"H | H105526L | \$634 | \$634 |
| 1 | Square End Cap Bookshelf Right 24"W x 24"D x 66"H | H105527R | \$1,017 | \$1,017 |
| 1 | H-Leg Support 30"W x 28¾"H | H105HLEG3028 | \$374 | \$374 |
| 1 | Rectangular Worksurface 66"W x 30"D | H105R3066 | \$397 | \$397 |
| 1 | External Stiffener 60"W | HLSLZ5SC72 | \$119 | \$119 |
| 1 | Fabric Tile 22½"H x 60"W | HWWT2260F | \$534 | \$534 |
| 1 | Slotted Tool Tile 15"H x 60"W | HWWT1560T | \$677 | \$677 |
| 1 | Glass Markerboard Tile 37½"H x 36"W | HWWT3736M | \$1,166 | \$1,166 |
| TOTAL: | | | | \$6,761 |

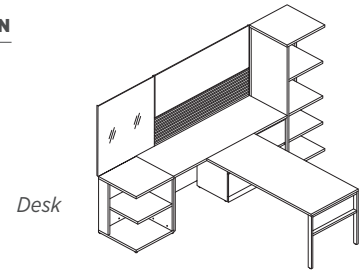

Desk

**10500 SERIES™
PRIVATE OFFICE**
118"W x 66½"H x 90"D

Workwall

| QTY | DESCRIPTION | MODEL | LIST PRICE | PRICE EXTENSION |
|---------------|---|-----------------|------------|-----------------|
| 1 | HAT Modular Credenza Top, Left 72"W x 24"D | H105CTHAT7224L | \$851 | \$851 |
| 1 | HAT Modular Credenza Top, Right 72"W x 24"D | H105CTHAT7224R | \$851 | \$851 |
| 2 | 2-Drawer Credenza, No Top 36"W x 24"D x 21½"H | H105LC3624BF | \$557 | \$1,114 |
| 2 | HAT Open Storage Cabinet Back 36"W x 21½"H | H105LCHAT3620B | \$234 | \$468 |
| 1 | HAT Open Credenza, No Top 36"W x 24"D x 21½"H | H105LCHAT3624S | \$255 | \$255 |
| 1 | Open Wardrobe Tower, B/F Left 18"W x 24"D x 50"H | H105LT182450BFL | \$2,014 | \$2,014 |
| 1 | Open Wardrobe Tower, B/F Right 18"W x 24"D x 50"H | H105LT182450BFR | \$2,014 | \$2,014 |
| 2 | Rectangular Worksurface 72"W x 30"D | H105R3072 | \$427 | \$854 |
| 2 | Shroud for Height Adjustable Base 5⅞"W x 26"D x 26¼"H | HLAMSHB30 | \$899 | \$1,798 |
| 2 | Height Adjustable Base 3 Stage, 2-Leg, Rectangle T Foot | HREC3S2LTF | \$1,210 | \$2,420 |
| 2 | External Stiffener 66"W | HLSLZ5SC78 | \$119 | \$238 |
| 2 | Fabric Tile 45"H x 36"W | HWWT4536F | \$518 | \$1,036 |
| 2 | Laminate Tile 37½"H x 35"W | HWWT3736L | \$459 | \$918 |
| 1 | Laminate Tile 15"H x 36"W | HWWT1536L | \$324 | \$324 |
| 2 | Slotted Tool Tile 7½"H x 36"W | HWWT736T | \$430 | \$860 |
| 2 | Floating Shelf 36"W | HWWASHELF36 | \$273 | \$546 |
| TOTAL: | | | | \$16,561 |

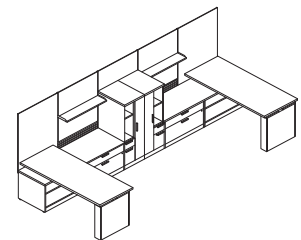

Desk

**10500 SERIES™
TEAMING STATION**
180"W x 64"H x 73"D

Workwall

NOTES: To enhance Workwall, use accessories, single tool rail, or floating shelf. See pages 263-264.

WORKWALL Typicals

| QTY | DESCRIPTION | MODEL | LIST PRICE | PRICE EXTENSION |
|---------------|--|-----------|-----------------|-----------------|
| 3 | Lateral File Pedestal 36"W x 20"D x 28"H | H10503 | \$1,105 | \$3,315 |
| 2 | Storage Cabinet/Lateral File 36"W x 20"D x 66 ⁵ / ₈ "H | H105293 | \$2,415 | \$4,830 |
| 1 | Rectangle Worksurface 36"W x 24"D | H105R2436 | \$220 | \$220 |
| 1 | Rectangle Worksurface 72"W x 24"D | H105R2472 | \$363 | \$363 |
| 10 | Field Installed Pull Kit Linear Matte Chrome, 2-Pack | HLINEARC2 | \$61 | \$610 |
| 2 | Fabric Tile 7 ¹ / ₂ "H x 36"W | HWWT736F | \$333 | \$666 |
| 2 | Slotted Tool Tile 15"H x 36"W | HWWT1536T | \$477 | \$954 |
| 2 | Fabric Tile 15"H x 36"W | HWWT1536F | \$351 | \$702 |
| 1 | Glass Markerboard Tile 37 ¹ / ₂ "H x 36"W | HWWT3736M | \$1,166 | \$1,166 |
| TOTAL: | | | \$12,826 | |

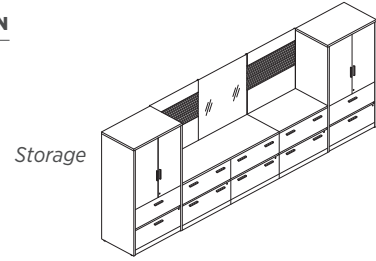

Storage

**10500 SERIES™
STORAGE WALL**
180"W x 66"H x 24"D

Workwall

| QTY | DESCRIPTION | MODEL | LIST PRICE | PRICE EXTENSION |
|---------------|---|--------------|----------------|-----------------|
| 1 | 2-Drawer Lateral File 36"W x 24"D | HNL2436LD2 | \$1,278 | \$1,278 |
| 1 | Pedestal Credenza, Right 72"W x 24"D | HNL2472RP | \$1,586 | \$1,586 |
| 1 | Bridge with Full Modesty 48"W x 24"D | HNL2448BF | \$491 | \$491 |
| 1 | Breakfront Rectangle Desk w/Frosted Modesty 72"W x 36"D | HNL3672LPRBF | \$2,608 | \$2,608 |
| 1 | Laminate Tile 45"H x 36"W | HWWT4536L | \$508 | \$508 |
| 1 | Glass Markerboard Tile 45"H x 48"W | HWWT4548M | \$1,474 | \$1,474 |
| 1 | Fabric Tile 45"H x 24"W | HWWT4524F | \$441 | \$441 |
| 2 | Floating Shelf 36"W | HWWASHELF36 | \$273 | \$546 |
| TOTAL: | | | \$8,932 | |

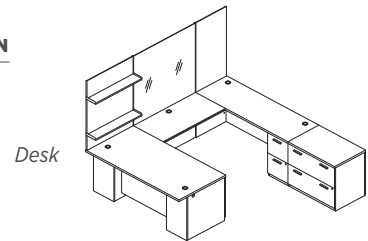

Desk

**CONCINNITY™
PRIVATE OFFICE**
108"W x 74"H x 108"D

Workwall

| QTY | DESCRIPTION | MODEL | LIST PRICE | PRICE EXTENSION |
|---------------|--|--------------|----------------|-----------------|
| 1 | O-Leg Support 30"D x 28"H | HLSL3028O | \$395 | \$395 |
| 1 | Bookcase End Support 12"W x 30"D x 28 ¹ / ₂ "H | HNL123028BKE | \$556 | \$556 |
| 2 | Low Credenza, 2 Box/2 File 60"W x 20"D x 21 ¹ / ₂ "H | HNL206021D4 | \$1,660 | \$3,320 |
| 1 | Storage Cabinet/Lateral File 36"W x 24"D x 64 ³ / ₄ "H | HNL243665SLL | \$2,553 | \$2,553 |
| 1 | Rectangle Worksurface 72"W x 30"D | HNLRC3072 | \$470 | \$470 |
| 2 | Fabric Tile 37 ¹ / ₂ "H x 60"W | HWWT3760F | \$662 | \$1,324 |
| 1 | Laminate Tile 37 ¹ / ₂ "H x 30"W | HWWT3730L | \$432 | \$432 |
| 2 | Floating Shelf 30"W | HWWASHELF30 | \$260 | \$520 |
| TOTAL: | | | \$9,570 | |

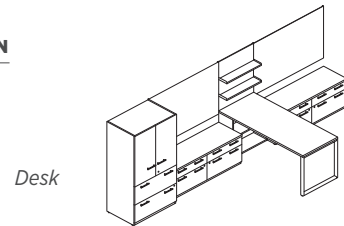

Desk

**CONCINNITY™ LARGE
PRIVATE OFFICE**
186"W x 64"H x 73"D

Workwall

NOTES: To enhance Workwall, use accessories, single tool rail, or floating shelf. See pages 263-264.

WORKWALL Typicals

| QTY | DESCRIPTION | MODEL | LIST PRICE | PRICE EXTENSION |
|---------------|---|-------------|-----------------|-----------------|
| 1 | Low Credenza, 2 File Drawers and Open Top 72"W x 20"D x 21½"H | HLSL2072LD2 | \$1,688 | \$1,688 |
| 2 | Support Pedestal 41"H | HLSL2441S | \$1,657 | \$3,314 |
| 2 | Angled Steel Leg 2-Pack | HLSL28AM2 | \$356 | \$712 |
| 1 | Rectangle Worksurface 72"W x 24"D | HLSLR2472 | \$443 | \$443 |
| 1 | Rectangle Worksurface 72"W x 30"D | HLSLR3072 | \$527 | \$527 |
| 1 | External Stiffener 60"W | HLSLZ55C72 | \$119 | \$119 |
| 1 | Low Credenza, 4 Storage Doors 72"W x 20"D x 21½"H | HLSL2072S4 | \$1,792 | \$1,792 |
| 2 | Laminate Tile 45"H x 36"W | HWWT4536L | \$508 | \$1,016 |
| 2 | Painted Metal Tile 22½"H x 36"W | HWWT2236P | \$293 | \$586 |
| 1 | Fabric Tile 45"H x 36"W | HWWT4536F | \$518 | \$518 |
| 1 | Glass Markerboard Tile 45"H x 36"W | HWWT4536M | \$1,276 | \$1,276 |
| TOTAL: | | | \$11,991 | |

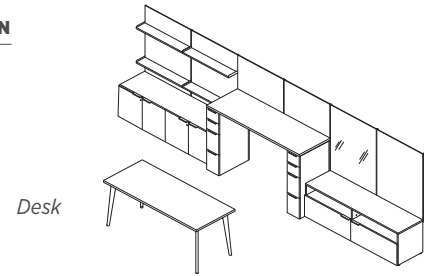

**VOI®
PRIVATE OFFICE**
216"W x 64"H x 107"D*

*Depth is dependent on how far the table desk is away from Workwall.

| QTY | DESCRIPTION | MODEL | LIST PRICE | PRICE EXTENSION |
|---------------|--|-------------|----------------|-----------------|
| 1 | Seated Height Mobile Collaborative Table 72"W x 42"D | HTMC304272 | \$2,050 | \$2,050 |
| 1 | Fabric Tile 45"H x 24"W | HWWT4524F | \$441 | \$441 |
| 1 | Laminate Tile 45"H x 24"W | HWWT4524L | \$448 | \$448 |
| 1 | Glass Markerboard Tile 45"H x 60"W | HWWT4560M | \$1,826 | \$1,826 |
| 1 | Floating Shelf 24"W | HWWASHELF24 | \$247 | \$247 |
| TOTAL: | | | \$5,012 | |

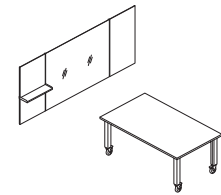

**OPEN COLLABORATIVE
WALL SPACE**
108"W x 45"H

| QTY | DESCRIPTION | MODEL | LIST PRICE | PRICE EXTENSION |
|---------------|--|--------------|----------------|-----------------|
| 4 | Lateral File Pedestal 30"W x 23⅞"D x 28½"H | HNL233028PLF | \$1,054 | \$4,216 |
| 2 | Modesty Back Panel, Full Length 60"W x 27⅞"H | HNLMP6028 | \$267 | \$534 |
| 2 | Rectangle Worksurface 60"W x 24"D | HNLRC2460 | \$358 | \$716 |
| 1 | Rectangle Table Top 96"W x 48"D | HTLC4896 | \$914 | \$914 |
| 1 | Angled Metal Legs for 96"W Tops 29½"H | HT29AL96 | \$1,609 | \$1,609 |
| 2 | Laminate Tile 37½"H x 36"W | HWWT3736L | \$459 | \$918 |
| 1 | Laminate Media Tile 37½"H x 48"W | HWWT3748V | \$569 | \$569 |
| 1 | Floating Shelf 36"W | HWWASHELF36 | \$273 | \$273 |
| 1 | Single Tool Rail 36"W | HWWARAIL36 | \$219 | \$219 |
| TOTAL: | | | \$9,968 | |

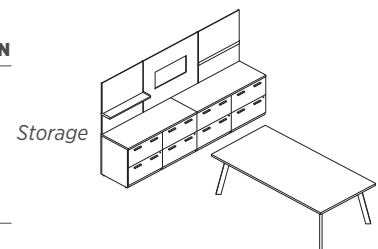

**STORAGE WALL IN
OPEN COLLABORATIVE SPACE**
120"W x 66"H x 30"D

NOTES: To enhance Workwall, use accessories, single tool rail, or floating shelf. See pages 263-264.

WORKWALL

Fabric Tiles

OPEN MARKET

Icon Legend on page 19

| DESCRIPTION | MODEL | SHIP WEIGHT | CUBE | LIST PRICE BY FABRIC GRADE | | | | | | | | |
|---------------------------|-----------|-------------|------|----------------------------|-------|-------|-------|-------|-------|-------|-------|--|
| | | | | AA | A | B | C | D | E | F | G | |
| 7½"H Fabric Tiles | | | | | | | | | | | | |
| 7½"H x 18"W | HWWT718F | 4 | 0.7 | \$286 | \$290 | \$293 | \$295 | \$301 | \$306 | \$311 | \$314 | |
| 7½"H x 24"W | HWWT724F | 4 | 0.8 | \$302 | \$306 | \$309 | \$311 | \$317 | \$322 | \$327 | \$330 | |
| 7½"H x 30"W | HWWT730F | 4 | 1.0 | \$320 | \$324 | \$327 | \$331 | \$337 | \$344 | \$347 | \$350 | |
| 7½"H x 36"W | HWWT736F | 4 | 1.3 | \$333 | \$337 | \$340 | \$344 | \$350 | \$357 | \$360 | \$363 | |
| 7½"H x 42"W | HWWT742F | 4 | 1.5 | \$419 | \$424 | \$428 | \$432 | \$442 | \$445 | \$449 | \$453 | |
| 7½"H x 48"W | HWWT748F | 4 | 1.5 | \$444 | \$449 | \$453 | \$457 | \$467 | \$470 | \$474 | \$478 | |
| 7½"H x 54"W | HWWT754F | 5 | 1.7 | \$450 | \$470 | \$474 | \$479 | \$491 | \$495 | \$498 | \$501 | |
| 7½"H x 60"W | HWWT760F | 5 | 1.8 | \$464 | \$484 | \$488 | \$493 | \$505 | \$509 | \$512 | \$515 | |
| 15"H Fabric Tiles | | | | | | | | | | | | |
| 15"H x 18"W | HWWT1518F | 4 | 1.0 | \$300 | \$309 | \$317 | \$325 | \$341 | \$359 | \$375 | \$383 | |
| 15"H x 24"W | HWWT1524F | 4 | 1.0 | \$319 | \$328 | \$336 | \$344 | \$360 | \$378 | \$394 | \$402 | |
| 15"H x 30"W | HWWT1530F | 4 | 1.2 | \$336 | \$347 | \$357 | \$367 | \$389 | \$410 | \$421 | \$431 | |
| 15"H x 36"W | HWWT1536F | 4 | 1.4 | \$351 | \$362 | \$372 | \$382 | \$404 | \$425 | \$436 | \$446 | |
| 15"H x 42"W | HWWT1542F | 4 | 1.6 | \$441 | \$454 | \$466 | \$481 | \$514 | \$525 | \$535 | \$546 | |
| 15"H x 48"W | HWWT1548F | 4 | 1.7 | \$463 | \$476 | \$488 | \$503 | \$536 | \$547 | \$557 | \$568 | |
| 15"H x 54"W | HWWT1554F | 5 | 2.1 | \$477 | \$490 | \$502 | \$517 | \$550 | \$561 | \$571 | \$582 | |
| 15"H x 60"W | HWWT1560F | 5 | 2.1 | \$490 | \$503 | \$515 | \$530 | \$563 | \$574 | \$584 | \$595 | |
| 22½"H Fabric Tiles | | | | | | | | | | | | |
| 22½"H x 18"W | HWWT2218F | 5 | 1.0 | \$318 | \$328 | \$337 | \$347 | \$366 | \$388 | \$402 | \$411 | |
| 22½"H x 24"W | HWWT2224F | 5 | 1.3 | \$337 | \$347 | \$356 | \$366 | \$385 | \$407 | \$421 | \$430 | |
| 22½"H x 30"W | HWWT2230F | 5 | 1.3 | \$356 | \$368 | \$379 | \$392 | \$415 | \$443 | \$470 | \$480 | |
| 22½"H x 36"W | HWWT2236F | 5 | 1.7 | \$379 | \$394 | \$407 | \$418 | \$455 | \$485 | \$496 | \$506 | |
| 22½"H x 42"W | HWWT2242F | 5 | 1.7 | \$473 | \$488 | \$501 | \$515 | \$558 | \$582 | \$593 | \$604 | |
| 22½"H x 48"W | HWWT2248F | 5 | 2.1 | \$494 | \$509 | \$522 | \$536 | \$579 | \$603 | \$614 | \$625 | |
| 22½"H x 54"W | HWWT2254F | 6 | 2.1 | \$523 | \$538 | \$551 | \$565 | \$608 | \$632 | \$643 | \$654 | |
| 22½"H x 60"W | HWWT2260F | 6 | 2.3 | \$534 | \$549 | \$562 | \$576 | \$619 | \$643 | \$654 | \$665 | |



NOTES:

- Accepts single tool rail, accessories, and floating shelf on select sizes (see pages 263-264 for accessory sizes).
- Fabric tiles are tackable.

ⓘ Tiles with accessories or shelves could conflict with the movement of height adjustable table.

HOW TO SPECIFY

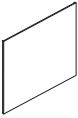
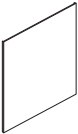
| | | |
|--|--|---|
| Select Model Number HWWT 2 2 3 6 F | Select Fabric Color See pages 25-26 A P N 1 5 | Select Mounting Hardware Paint P Black PJW Designer White S Charcoal P |
|--|--|---|

| | DESCRIPTION | MODEL | SHIP WEIGHT | CUBE | LIST PRICE BY FABRIC GRADE | | | | | | | | |
|---|------------------------------|------------------|-------------|------|----------------------------|-------|-------|-------|-------|--------|--------|--------|--|
| | | | | | AA | A | B | C | D | E | F | G | |
|  | 30"H Fabric Tiles | | | | | | | | | | | | |
| | 30"H x 18"W | HWWT3018F | 5 | 1.2 | \$334 | \$345 | \$355 | \$366 | \$388 | \$415 | \$426 | \$436 | |
| | 30"H x 24"W | HWWT3024F | 5 | 1.7 | \$358 | \$369 | \$379 | \$390 | \$412 | \$439 | \$450 | \$460 | |
| | 30"H x 30"W | HWWT3030F | 5 | 2.1 | \$386 | \$399 | \$411 | \$426 | \$451 | \$485 | \$529 | \$539 | |
| | 30"H x 36"W | HWWT3036F | 5 | 2.5 | \$410 | \$428 | \$444 | \$456 | \$509 | \$547 | \$558 | \$568 | |
| | 30"H x 42"W | HWWT3042F | 6 | 2.9 | \$516 | \$532 | \$547 | \$559 | \$613 | \$650 | \$662 | \$672 | |
| | 30"H x 48"W | HWWT3048F | 6 | 3.3 | \$535 | \$551 | \$566 | \$578 | \$632 | \$669 | \$681 | \$691 | |
| | 30"H x 54"W | HWWT3054F | 7 | 4.1 | \$559 | \$575 | \$590 | \$602 | \$656 | \$693 | \$705 | \$715 | |
| | 30"H x 60"W | HWWT3060F | 7 | 4.1 | \$581 | \$597 | \$612 | \$624 | \$678 | \$715 | \$727 | \$737 | |
|  | 37 1/2"H Fabric Tiles | | | | | | | | | | | | |
| | 37 1/2"H x 18"W | HWWT3718F | 6 | 1.6 | \$361 | \$377 | \$392 | \$410 | \$463 | \$495 | \$507 | \$517 | |
| | 37 1/2"H x 24"W | HWWT3724F | 6 | 2.1 | \$400 | \$416 | \$431 | \$449 | \$502 | \$534 | \$546 | \$556 | |
| | 37 1/2"H x 30"W | HWWT3730F | 7 | 2.6 | \$427 | \$443 | \$458 | \$476 | \$529 | \$561 | \$573 | \$583 | |
| | 37 1/2"H x 36"W | HWWT3736F | 8 | 2.5 | \$454 | \$473 | \$492 | \$513 | \$577 | \$624 | \$635 | \$646 | |
| | 37 1/2"H x 42"W | HWWT3742F | 8 | 3.6 | \$571 | \$592 | \$612 | \$636 | \$717 | \$765 | \$775 | \$786 | |
| | 37 1/2"H x 48"W | HWWT3748F | 9 | 4.1 | \$602 | \$623 | \$645 | \$668 | \$751 | \$800 | \$812 | \$823 | |
| | 37 1/2"H x 54"W | HWWT3754F | 10 | 3.2 | \$627 | \$653 | \$679 | \$710 | \$792 | \$852 | \$863 | \$875 | |
| | 37 1/2"H x 60"W | HWWT3760F | 11 | 5.2 | \$662 | \$688 | \$714 | \$745 | \$827 | \$887 | \$898 | \$910 | |
|  | 45"H Fabric Tiles | | | | | | | | | | | | |
| | 45"H x 18"W | HWWT4518F | 6 | 1.8 | \$401 | \$420 | \$440 | \$461 | \$527 | \$575 | \$586 | \$598 | |
| | 45"H x 24"W | HWWT4524F | 6 | 2.5 | \$441 | \$460 | \$480 | \$501 | \$567 | \$615 | \$626 | \$638 | |
| | 45"H x 30"W | HWWT4530F | 7 | 3.1 | \$482 | \$503 | \$523 | \$548 | \$631 | \$679 | \$691 | \$703 | |
| | 45"H x 36"W | HWWT4536F | 8 | 3.7 | \$518 | \$539 | \$561 | \$584 | \$667 | \$716 | \$728 | \$739 | |
| | 45"H x 42"W | HWWT4542F | 8 | 4.3 | \$644 | \$665 | \$685 | \$710 | \$792 | \$841 | \$853 | \$865 | |
| | 45"H x 48"W | HWWT4548F | 9 | 5.0 | \$685 | \$706 | \$734 | \$751 | \$834 | \$883 | \$895 | \$906 | |
| | 45"H x 54"W | HWWT4554F | 10 | 6.2 | \$725 | \$751 | \$778 | \$809 | \$890 | \$950 | \$962 | \$974 | |
| | 45"H x 60"W | HWWT4560F | 11 | 6.2 | \$775 | \$801 | \$828 | \$859 | \$940 | \$1000 | \$1012 | \$1024 | |

NOTES:

- Accepts single tool rail, accessories, and floating shelf on select sizes (see pages 263-264 for accessory sizes).
- Fabric tiles are tackable.

! Tiles with accessories or shelves could conflict with the movement of height adjustable table.

HOW TO SPECIFY

| | | |
|--|---|--|
| <p>Select Model Number</p> <p>HWWT3036F</p> | <p>Select Fabric Color</p> <p>See pages 25-26</p> <p>APN15</p> | <p>Select Mounting Hardware Paint</p> <p>P Black PJV Designer White S Charcoal</p> <p>P</p> |
|--|---|--|

WORKWALL

Glass Markerboard Tiles

OPEN MARKET

Icon Legend on page 19

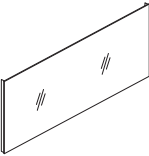
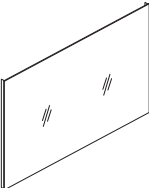
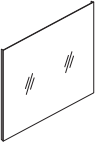
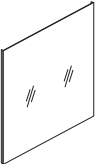
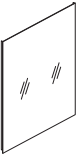
| | DESCRIPTION | MODEL | SHIP WEIGHT | CUBE | LIST PRICE |
|--|--------------------------------------|--------------------------------------|-------------|------------|-------------------------------|
|  | 15"H Glass Markerboard Tiles | | | | |
| | 15"H x 30"W 15"H x 36"W | HWWT1530M HWWT1536M | 16 18 | 2.2 2.6 | \$594 \$660 |
|  | 22½"H Glass Markerboard Tiles | | | | |
| | 22½"H x 30"W 22½"H x 36"W | HWWT2230M HWWT2236M | 21 24 | 3.1 3.6 | \$792 \$880 |
|  | 30"H Glass Markerboard Tiles | | | | |
| | 30"H x 30"W 30"H x 36"W | HWWT3030M HWWT3036M | 25 29 | 4.0 4.7 | \$968 \$1034 |
|  | 37½"H Glass Markerboard Tiles | | | | |
| | 37½"H x 30"W | HWWT3730M | 30 | 4.8 | \$1100 |
| | 37½"H x 36"W | HWWT3736M | 35 | 5.7 | \$1166 |
| | 37½"H x 42"W | HWWT3742M | 40 | 6.5 | \$1232 |
| | 37½"H x 48"W | HWWT3748M | 44 | 7.4 | \$1342 |
| | 37½"H x 54"W | HWWT3754M | 48 | 8.3 | \$1452 |
|  | 45"H Glass Markerboard Tiles | | | | |
| | 45"H x 30"W | HWWT4530M | 35 | 5.8 | \$1188 |
| | 45"H x 36"W | HWWT4536M | 41 | 6.8 | \$1276 |
| | 45"H x 42"W | HWWT4542M | 46 | 7.8 | \$1364 |
| | 45"H x 48"W | HWWT4548M | 52 | 8.8 | \$1474 |
| | 45"H x 54"W | HWWT4554M | 58 | 9.9 | \$1694 |
| | 45"H x 60"W | HWWT4560M | 63 | 10.9 | \$1826 |

NOTES:

- Markerboard is magnetic. Recommend using rare earth magnets for best results.
- Material is back-painted glass with square edges, low iron clear (glossy) completely opaque finish and is tempered glass.

HOW TO SPECIFY

| | | |
|---|---|---|
| Select Model Number <div style="border: 1px solid black; padding: 2px; display: flex; gap: 5px;"> HWWT3036M </div> | Select Glass GBG2 Beige GCH2 Charcoal GCR2 Cream GWH2 Ice White GPB2 Pebble | Select Mounting Hardware Paint P Black PJW Designer White S Charcoal |
| | <div style="border: 1px solid black; padding: 2px; display: flex; gap: 5px;"> GCH2 </div> | <div style="border: 1px solid black; padding: 2px; display: flex; gap: 5px;"> P </div> |

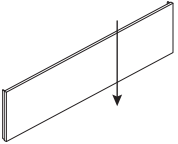
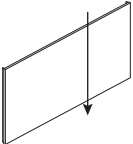
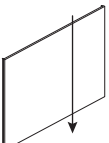
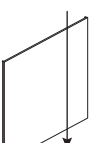
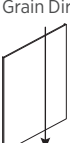
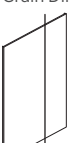
| | DESCRIPTION | MODEL | SHIP WEIGHT | CUBE | LIST PRICE BY LAMINATE GRADE | |
|--|-----------------------------|------------------|-------------|------|------------------------------|--------------|
| | | | | | L1 | L2 |
| Grain Direction  | 7½”H Laminate Tiles | | | | | |
| | 7½”H x 18”W | HWWT718L | 5 | 0.7 | \$279 | \$284 |
| | 7½”H x 24”W | HWWT724L | 5 | 0.8 | \$285 | \$295 |
| | 7½”H x 30”W | HWWT730L | 6 | 1.0 | \$291 | \$301 |
| | 7½”H x 36”W | HWWT736L | 6 | 1.2 | \$296 | \$306 |
| Grain Direction  | 15”H Laminate Tiles | | | | | |
| | 15”H x 18”W | HWWT1518L | 6 | 1.0 | \$297 | \$302 |
| | 15”H x 24”W | HWWT1524L | 7 | 1.0 | \$305 | \$315 |
| | 15”H x 30”W | HWWT1530L | 8 | 1.2 | \$315 | \$325 |
| | 15”H x 36”W | HWWT1536L | 9 | 1.4 | \$324 | \$334 |
| Grain Direction  | 22½”H Laminate Tiles | | | | | |
| | 22½”H x 18”W | HWWT2218L | 10 | 1.0 | \$319 | \$329 |
| | 22½”H x 24”W | HWWT2224L | 11 | 2.6 | \$332 | \$347 |
| | 22½”H x 30”W | HWWT2230L | 13 | 2.6 | \$346 | \$361 |
| | 22½”H x 36”W | HWWT2236L | 14 | 4.2 | \$360 | \$375 |
| Grain Direction  | 30”H Laminate Tiles | | | | | |
| | 30”H x 18”W | HWWT3018L | 11 | 1.2 | \$338 | \$348 |
| | 30”H x 24”W | HWWT3024L | 13 | 1.5 | \$358 | \$373 |
| | 30”H x 30”W | HWWT3030L | 15 | 1.8 | \$376 | \$391 |
| | 30”H x 36”W | HWWT3036L | 17 | 2.1 | \$392 | \$407 |
| Grain Direction  | 37½”H Laminate Tiles | | | | | |
| | 37½”H x 18”W | HWWT3718L | 15 | 1.5 | \$378 | \$393 |
| | 37½”H x 24”W | HWWT3724L | 17 | 1.8 | \$405 | \$425 |
| | 37½”H x 30”W | HWWT3730L | 19 | 2.2 | \$432 | \$452 |
| | 37½”H x 36”W | HWWT3736L | 22 | 2.5 | \$459 | \$479 |
| Grain Direction  | 45”H Laminate Tiles | | | | | |
| | 45”H x 18”W | HWWT4518L | 16 | 1.7 | \$418 | \$433 |
| | 45”H x 24”W | HWWT4524L | 19 | 2.1 | \$448 | \$468 |
| | 45”H x 30”W | HWWT4530L | 22 | 2.5 | \$478 | \$498 |
| | 45”H x 36”W | HWWT4536L | 25 | 3.0 | \$508 | \$528 |

NOTES:

• Accepts single tool rail, accessories, and floating shelf on select sizes (see pages 263-264 for accessory sizes).

ⓘ Tiles with accessories or shelves could conflict with the movement of height adjustable table.

HOW TO SPECIFY

| | | |
|--|--|--|
| <p>Select Model Number</p> <p>HWWT3036L</p> | <p>Select Laminate and Edge</p> <p>See page 246</p> <p>LSA1SA</p> | <p>Select Mounting Hardware Paint</p> <p>P Black PJW Designer White S Charcoal</p> <p>P</p> |
|--|--|--|

WORKWALL Laminate Media Tiles

OPEN MARKET

Icon Legend on page 19

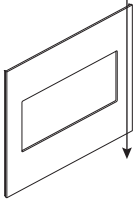
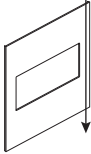
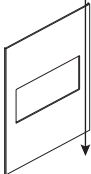
| | DESCRIPTION | MODEL | SHIP WEIGHT | CUBE | LIST PRICE BY LAMINATE GRADE | |
|---|---------------------------------------|------------------|-------------|------|------------------------------|--------------|
| | | | | | L1 | L2 |
| Grain Direction  | 30" H Laminate Media Tiles | | | | | |
| | 30" H x 36" W | HWWT3036V | 9 | 2.1 | \$442 | \$457 |
| | 30" H x 42" W | HWWT3042V | 11 | 2.4 | \$472 | \$487 |
| | 30" H x 48" W | HWWT3048V | 14 | 2.7 | \$502 | \$522 |
| Grain Direction  | 37 1/2" H Laminate Media Tiles | | | | | |
| | 37 1/2" H x 36" W | HWWT3736V | 14 | 2.5 | \$509 | \$529 |
| | 37 1/2" H x 42" W | HWWT3742V | 16 | 2.9 | \$539 | \$559 |
| | 37 1/2" H x 48" W | HWWT3748V | 19 | 3.2 | \$569 | \$594 |
| | 37 1/2" H x 54" W | HWWT3754V | 21 | 3.6 | \$599 | \$624 |
| Grain Direction  | 45" H Laminate Media Tiles | | | | | |
| | 45" H x 36" W | HWWT4536V | 17 | 3.0 | \$558 | \$578 |
| | 45" H x 42" W | HWWT4542V | 20 | 3.4 | \$588 | \$613 |
| | 45" H x 48" W | HWWT4548V | 23 | 3.8 | \$618 | \$643 |
| | 45" H x 54" W | HWWT4554V | 26 | 4.2 | \$648 | \$678 |

NOTES:

- Media tile does not include wire management. Intended for power to be behind TV. Cords do not route behind tile.
- Tiles with accessories or shelves could conflict with the movement of height adjustable table.
- Wire management or television mounting brackets not included with tiles.

| TV SCREEN DIMENSIONS | | | Workwall Tile | APPROXIMATE DIMENSIONS AROUND TV | |
|----------------------|---------------|--------------|---------------|----------------------------------|---------------------|
| TV Size | Screen Height | Screen Width | | Top & Bottom Border | Left & Right Border |
| 32 | 15.7 | 27.9 | HWWT3036M | 7" | 4" |
| | | | HWWT3736M | 10.5" | |
| | | | HWWT4536M | 14.5" | |
| 40 | 19.6 | 34.9 | HWWT3042M | 5" | 3.5" |
| | | | HWWT3742M | 8.5" | |
| | | | HWWT4542V | 12.5" | |
| 43 | 21.1 | 37.5 | HWWT3048V | 4" | 5" |
| | | | HWWT3748V | 8" | |
| | | | HWWT4548V | 11.5" | |
| 50 | 24.5 | 43.6 | HWWT3748V | 6" | 2" |
| | | | HWWT4548V | 10" | |
| | | | HWWT3754V | 6" | 5" |
| | | | HWWT4554V | 10" | |

NOTES:

- TV true size height and width are for screen only, it does not take TV/monitor bevel into account. Please note chart is directional for TV sizes and actual dimensions should be confirmed with TV manufacturer.
- Borders show dimensions of visual laminate tile around the outside of the TV.
- TV Mount Opening is 12"H x 27"W and is centered on all Media Tiles.

HOW TO SPECIFY

| | | |
|--|--|--|
| <p>Select Model Number</p> <p>HWWT3036V</p> | <p>Select Laminate and Edge</p> <p>See page 246</p> <p>LSA1SA</p> | <p>Select Mounting Hardware Paint</p> <p>P Black PJW Designer White S Charcoal</p> <p>P</p> |
|--|--|--|

WORKWALL

Painted Metal Tiles

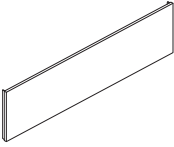
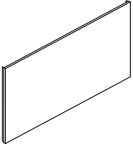
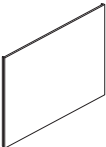
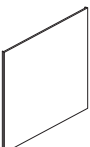
| | DESCRIPTION | MODEL | SHIP WEIGHT | CUBE | LIST PRICE BY PAINT GRADE | | |
|--|----------------------------------|-----------|-------------|------|---------------------------|-------|-------|
| | | | | | P1 | P2 | P3 |
|  | 7½"H Painted Metal Tiles | | | | | | |
| | 7½"H x 18"W | HWWT718P | 4 | 0.7 | \$213 | \$228 | \$242 |
| | 7½"H x 24"W | HWWT724P | 4 | 0.8 | \$233 | \$248 | \$264 |
| | 7½"H x 30"W | HWWT730P | 6 | 1.0 | \$253 | \$268 | \$286 |
| | 7½"H x 36"W | HWWT736P | 6 | 1.2 | \$273 | \$288 | \$310 |
|  | 15"H Painted Metal Tiles | | | | | | |
| | 15"H x 18"W | HWWT1518P | 6 | 1.0 | \$223 | \$244 | \$259 |
| | 15"H x 24"W | HWWT1524P | 6 | 1.0 | \$243 | \$264 | \$281 |
| | 15"H x 30"W | HWWT1530P | 7 | 1.2 | \$263 | \$284 | \$303 |
| | 15"H x 36"W | HWWT1536P | 7 | 1.4 | \$283 | \$304 | \$327 |
|  | 22½"H Painted Metal Tiles | | | | | | |
| | 22½"H x 18"W | HWWT2218P | 8 | 1.0 | \$233 | \$260 | \$276 |
| | 22½"H x 24"W | HWWT2224P | 8 | 1.3 | \$253 | \$280 | \$298 |
| | 22½"H x 30"W | HWWT2230P | 9 | 1.3 | \$273 | \$300 | \$320 |
| | 22½"H x 36"W | HWWT2236P | 9 | 1.7 | \$293 | \$320 | \$344 |
|  | 30"H Painted Metal Tiles | | | | | | |
| | 30"H x 18"W | HWWT3018P | 9 | 1.2 | \$243 | \$276 | \$293 |
| | 30"H x 24"W | HWWT3024P | 9 | 1.7 | \$263 | \$296 | \$318 |
| | 30"H x 30"W | HWWT3030P | 10 | 2.1 | \$283 | \$316 | \$343 |
| | 30"H x 36"W | HWWT3036P | 11 | 2.5 | \$303 | \$336 | \$371 |

NOTES:

- Accepts single tool rail, accessories, and floating shelf on select sizes (see pages 263-264 for accessory sizes).
- Metal tiles are magnetic.

! Tiles with accessories or shelves could conflict with the movement of height adjustable table.

HOW TO SPECIFY

| | | |
|---|---|---|
| Select Model Number HWWT3036P | Select Tile Paint Color See page 246 PJW | Select Mounting Hardware Paint P Black PJW Designer White S Charcoal P |
|---|---|---|

WORKWALL

Slotted Tool Tiles

OPEN MARKET

Icon Legend on page 19

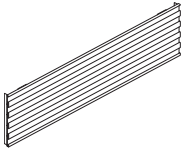
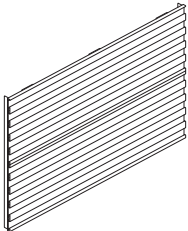
| | DESCRIPTION | MODEL | SHIP WEIGHT | CUBE | LIST PRICE BY PAINT GRADE | | |
|--|------------------------------------|-----------|-------------|------|---------------------------|-------|-------|
| | | | | | P1 | P2 | P3 |
|  | 7 1/2" H Slotted Tool Tiles | | | | | | |
| | 7 1/2" H x 24" W | HWWT724T | 6 | 0.8 | \$343 | \$358 | \$381 |
| | 7 1/2" H x 30" W | HWWT730T | 7 | 1.0 | \$388 | \$403 | \$430 |
| | 7 1/2" H x 36" W | HWWT736T | 8 | 1.2 | \$430 | \$445 | \$476 |
| | 7 1/2" H x 42" W | HWWT742T | 9 | 1.3 | \$475 | \$490 | \$525 |
| | 7 1/2" H x 48" W | HWWT748T | 11 | 1.5 | \$520 | \$535 | \$573 |
| | 7 1/2" H x 54" W | HWWT754T | 12 | 1.7 | \$575 | \$590 | \$630 |
| | 7 1/2" H x 60" W | HWWT760T | 13 | 1.8 | \$630 | \$645 | \$687 |
|  | 15" H Slotted Tool Tiles | | | | | | |
| | 15" H x 24" W | HWWT1524T | 11 | 1.0 | \$390 | \$419 | \$442 |
| | 15" H x 30" W | HWWT1530T | 13 | 1.2 | \$434 | \$463 | \$490 |
| | 15" H x 36" W | HWWT1536T | 15 | 1.4 | \$477 | \$506 | \$537 |
| | 15" H x 42" W | HWWT1542T | 17 | 1.6 | \$522 | \$551 | \$586 |
| | 15" H x 48" W | HWWT1548T | 20 | 1.7 | \$567 | \$596 | \$634 |
| | 15" H x 54" W | HWWT1554T | 22 | 2.1 | \$622 | \$651 | \$691 |
| | 15" H x 60" W | HWWT1560T | 24 | 2.1 | \$677 | \$706 | \$748 |

NOTES:

- Abound® accessories can be used on Slotted Tool Tiles. See page 466.
- ! Slotted Tool Tile tested to 80 lbs. per tile (including accessories and what is stored in them) and must not exceed.
- ! Tiles with accessories or shelves could conflict with the movement of height adjustable table.

HOW TO SPECIFY

Select
Model Number

H W W T 1 5 3 6 T .

Select
Tile Paint Color

See page 246

P J W .

Select
Mounting Hardware Paint

P Black
P J W Designer White
S Charcoal

P

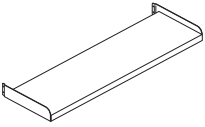
| | DESCRIPTION | MODEL | SHIP WEIGHT | CUBE | LIST PRICE | UPCHARGE BY LAMINATE/PAINT GRADE | | |
|---|-------------------------|--------------------|-------------|------|--------------|----------------------------------|------------|-------------|
| | | | | | | L2 | P2 | P3 |
|  | Floating Shelves | | | | | | | |
| | 18"W | HWWASHELF18 | 9 | 0.4 | \$234 | \$5 | \$6 | \$11 |
| | 24"W | HWWASHELF24 | 10 | 0.5 | \$247 | \$10 | \$6 | \$11 |
| | 30"W | HWWASHELF30 | 11 | 0.6 | \$260 | \$10 | \$6 | \$11 |
| | 36"W | HWWASHELF36 | 12 | 0.7 | \$273 | \$10 | \$6 | \$11 |

NOTES:

- Shelves can be mounted on laminate, fabric, and metal tiles.
 - Can be mounted up to 2 on a single tile.
 - Shelves tested to 50 lbs. per floating shelf.
 - Shelves can be mounted at predetermined locations, pilot holes included.
- ⚠ Tiles with accessories or shelves could conflict with the movement of height adjustable table.

HOW TO SPECIFY

| | | |
|--|--|--|
| <p>Select Model Number</p> <p>HWWASHELF36</p> | <p>Select Laminate and Edge</p> <p>See page 246</p> <p>LSA1SA</p> | <p>Select Floating Shelf Bracket Paint</p> <p>See page 246</p> <p>P</p> |
|--|--|--|

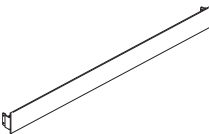
| | DESCRIPTION | MODEL | SHIP WEIGHT | CUBE | LIST PRICE BY PAINT GRADE | | |
|---|-----------------------------------|-------------------|-------------|------|---------------------------|--------------|--------------|
| | | | | | P1 | P2 | P3 |
|  | Single Tool Rail Accessory | | | | | | |
| | 18"W | HWWARAIL18 | 2 | 0.4 | \$192 | \$198 | \$203 |
| | 24"W | HWWARAIL24 | 2 | 0.4 | \$199 | \$205 | \$210 |
| | 30"W | HWWARAIL30 | 2 | 0.5 | \$212 | \$218 | \$223 |
| | 36"W | HWWARAIL36 | 3 | 0.6 | \$219 | \$225 | \$230 |
| | 42"W | HWWARAIL42 | 3 | 0.6 | \$231 | \$237 | \$242 |
| | 48"W | HWWARAIL48 | 4 | 0.7 | \$240 | \$246 | \$251 |
| | 54"W | HWWARAIL54 | 4 | 0.7 | \$259 | \$265 | \$270 |
| | 60"W | HWWARAIL60 | 4 | 0.8 | \$273 | \$279 | \$284 |

NOTES:

- Accessory rails can be mounted on laminate, laminate media, fabric, and metal tiles.
 - Can be mounted up to 2 on a single tile.
 - Accessory rails can be mounted at predetermined locations, pilot holes included.
 - Brackets match paint selected for single tool rail.
- ⚠ 18-36"W Single Tool Rails are tested to a distributed 20 lbs. per single tool rail (including accessories and what is stored in them) and must not exceed.
- ⚠ 42-60"W Single Tool Rails are tested to a distributed 10 lbs. per single tool rail (including accessories and what is stored in them) and must not exceed.
- ⚠ Abound® accessories cannot be used on single rail but can be used on Slotted Tool Tiles.
- ⚠ Tiles with accessories or shelves could conflict with the movement of height adjustable table.

HOW TO SPECIFY

| | |
|---|--|
| <p>Select Model Number</p> <p>HWWARAIL36</p> | <p>Select Single Tool Rail and Bracket Paint</p> <p>See page 246</p> <p>P</p> |
|---|--|

WORKWALL

Accessories

OPEN MARKET

Icon Legend on page 19

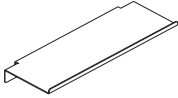
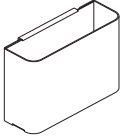
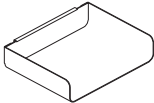
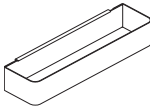
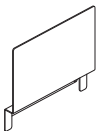
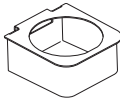
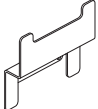
| | DESCRIPTION | MODEL | SHIP WEIGHT | CUBE | LIST PRICE BY PAINT GRADE | | |
|--|---|---------------|-------------|------|---------------------------|-------|-------|
| | | | | | P1 | P2 | P3 |
|  | Small Shelf 1"H x 10"W x 3/4"D | HWWATS | 2 | 0.1 | \$117 | \$123 | \$128 |
|  | Small Bin 4"H x 6"W x 2 1/4"D | HWWASB | 3 | 0.1 | \$117 | \$123 | \$128 |
|  | Small Tray 2"H x 9"W x 7/4"D | HWWAST | 2 | 0.1 | \$131 | \$137 | \$142 |
|  | Hanging File Folder 2"H x 12 1/4"W x 3 1/4"D | HWWAP | 1 | 0.1 | \$131 | \$137 | \$142 |
|  | Magnetic Picture Holder 5 1/4"H x 6"W x 3/4"D | HWWAPH | 2 | 0.5 | \$107 | \$113 | \$118 |
|  | Cup 2"H x 4 1/4"W x 4 1/2"D | HWWAC | 1 | 0.1 | \$107 | \$113 | \$118 |
|  | Hook 2 3/4"H x 3"W x 3/4"D | HWWAH | 1 | 0.1 | \$107 | \$113 | \$118 |

NOTES:

- Accessories work on single tool rail and Slotted Tool Tiles.

HOW TO SPECIFY

Select
Model Number

H W W A S T .

Select
Paint Color

See page 246

P

10500 SERIES™

Want to see more? Scan here
to check out hon.com.



10500 Series™ Workstation
shown with Ignition® Seating.

10500 SERIES™

Endlessly adaptable and unexpectedly affordable, our 10500 Series offers truly lasting value. The versatile design and options give you an even wider range of layout possibilities and the flexibility to maximize footprints — even smaller ones. And with more ways to customize your personal storage, the 10500 Series simply gives you more for less.



FEATURES

- The 10500 Series' fresh aesthetic includes airy H- or O-legs and frosted modesty panels.
- Available in 25 durable mix-and-match laminates, including new textured styles.
- With so many convenient and compact storage options, even the smallest footprints feel big.
- The versatile 10500 Series™ offers a variety of components to accommodate any size workspace.
- Support today's healthy work styles by offering the choice of sitting or standing while working, with storage options that fit your needs.

10500 SERIES™ ORDERING INFORMATION

LAMINATE TOP, CHASSIS, AND WORKSURFACES

L1 LAMINATES CODES

Woodgrain

| | |
|--------------------------|------|
| ◆ Bourbon Cherry | H |
| ◆ Cognac | COGN |
| ◆ Florence Walnut | LFW1 |
| ◆ Harvest | C |
| ◆ Kingswood Walnut | LK11 |
| ◆ Mahogany | N |
| ◆ Mocha | MOCH |
| ◆ Natural Maple | D |
| ◆ Pinnacle | PINC |
| ◆ Shaker Cherry | F |
| ◆ Sterling Ash | LSA1 |

Solid

| | |
|------------------------|------|
| ◆ Black | P |
| ◆ Charcoal | S |
| ◆ Designer White | LDW1 |
| ◆ Loft | LOFT |

Patterned Top

| | |
|---------------------------|-------|
| ◆ Grey Tigris * | L6(*) |
| ◆ Handspun Chestnut | LAHC |
| ◆ Handspun Dove | LAHD |
| ◆ Handspun Pearl | LAHP |
| ◆ Handspun Slate | LAHS |
| ◆ Sheer Mesh * | A5(*) |
| ◆ Silver Mesh | B9(*) |
| ◆ Canyon Zephyr * | K9(*) |
| ◆ Desert Zephyr * | K8(*) |

L2 LAMINATES CODES

Woodgrain

| | |
|------------------------|------|
| ◆ Lowell Ash | LLA1 |
| ◆ Natural Recon | LNRI |
| ◆ Phantom Ecrú | LPE1 |
| ◆ Portico Teak | LPT1 |
| ◆ Skyline Walnut | LSW1 |

EDGE BAND

EDGE BAND COLORS CODES

Woodgrain

| | |
|--------------------------|------|
| ◆ Bourbon Cherry | H |
| ◆ Cognac | COGN |
| ◆ Florence Walnut | FW |
| ◆ Harvest | C |
| ◆ Kingswood Walnut | KI |
| ◆ Lowell Ash | DL |
| ◆ Mahogany | N |
| ◆ Mocha | MOCH |
| ◆ Natural Maple | D |
| ◆ Natural Recon | NR |
| ◆ Phantom Ecrú | PE |
| ◆ Pinnacle | PINC |
| ◆ Portico Teak | DP |
| ◆ Shaker Cherry | F |
| ◆ Skyline Walnut | SW |
| ◆ Sterling Ash | SA |

Solid

| | |
|------------------------|------|
| ◆ Black | P |
| ◆ Brownstone | EY |
| ◆ Charcoal | S |
| ◆ Designer White | DW |
| ◆ Fossil | EH |
| ◆ Loft | LOFT |

10500 SERIES™ MOBILE TABLES

PAINTS CODES

P1

| | |
|------------------------|------|
| ◆ Black | P |
| ◆ Brownstone | P7D |
| ◆ Charcoal | S |
| ◆ Designer White | PJW |
| ◆ Fossil | P28 |
| ◆ Greige | T5 |
| ◆ Loft | LOFT |
| ◆ Muslin | T3 |
| ◆ Titanium | P8T |

P2

| | |
|----------------------------|-----|
| ◆ Champagne Metallic | T4 |
| ◆ Platinum Metallic | T1 |
| ◆ Silver | PR6 |

H-LEGS, O-LEGS, POST LEGS, STORAGE CUBE

PAINTS CODES

P1

| | |
|------------------------|------|
| ◆ Black | P |
| ◆ Brownstone | P7D |
| ◆ Charcoal | S |
| ◆ Designer White | PJW |
| ◆ Fossil | P28 |
| ◆ Greige | T5 |
| ◆ Loft | LOFT |
| ◆ Muslin | T3 |
| ◆ Shadow * | SHDW |
| ◆ Titanium | P8T |

P2

| | |
|----------------------------|-----|
| ◆ Champagne Metallic | T4 |
| ◆ Platinum Metallic | T1 |
| ◆ Silver | PR6 |
| ◆ Solar Black | P8X |

P3

| | |
|---------------------|------|
| ◆ Amethyst | P091 |
| ◆ Atom | P8S |
| ◆ Blossom | P8K |
| ◆ Bullseye | PJF |
| ◆ Cabernet * | P7T |
| ◆ Cobalt Mica | P090 |
| ◆ Conifer * | P8H |
| ◆ Ember | P8P |
| ◆ Ion | P8N |
| ◆ Iris | P8J |
| ◆ Krypton | P8F |
| ◆ Ochre | P093 |
| ◆ Regatta | P8M |
| ◆ Sienna | P092 |
| ◆ Succulent | P8A |

◆◆◆ For lead time information see page 19.

* De-emphasized

Patterned Top

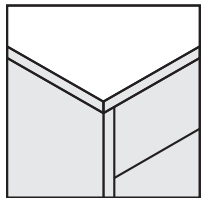

Edgeband Around Top / Laminate Chassis

- Edgebanding on patterned laminates matches the laminate chassis selected.
- Patterned top laminates are available with the following edgeband laminate selection: C, COGN, D, F, FW, H, KI, DW, MOCH, N, P, PINC, SA, and S.
- For 10500 Series™ worksurface models, the finish specification options include matching the top and edgeband colors or choosing a two-tone combination.

LAMINATE DESKS

SPECIFY: Model Number.
Laminate

EXAMPLE: H105413.NN

WORKSURFACES

SPECIFY: Model Number.
Top Laminate
Edgeband

- All specifications in this publication are based on the latest product information available at the time of print.

! Tops with a patterned color are not available with a matching edgeband.

10500 SERIES™ ORDERING INFORMATION

TWO-TONE LAMINATE TOP / CHASSIS

| L1 LAMINATES | CODES |
|-----------------------------------|----------|
| Two-Tone Top/Chassis | |
| ◆ Black/Charcoal | PS |
| ◆ Black/Designer White | PLDW1 |
| ◆ Black/Loft | PLOFT |
| ◆ Bourbon Cherry/Black | HP |
| ◆ Bourbon Cherry/Charcoal | HS |
| ◆ Bourbon Cherry/Designer White | HLDW1 |
| ◆ Bourbon Cherry/Loft | HLOFT |
| ◆ Charcoal/Black | SP |
| ◆ Charcoal/Designer White | SLDW1 |
| ◆ Charcoal/Loft | SOFT |
| ◆ Cognac/Black | COGNP |
| ◆ Cognac/Charcoal | COGNS |
| ◆ Cognac/Designer White | COGNLDW1 |
| ◆ Cognac/Loft | COGNLOFT |
| ◆ Designer White/Black | LDW1P |
| ◆ Designer White/Bourbon Cherry | LDW1H |
| ◆ Designer White/Charcoal | LDW1S |
| ◆ Designer White/Cognac | LDW1COGN |
| ◆ Designer White/Florence Walnut | LDW1LFW1 |
| ◆ Designer White/Harvest | LDW1C |
| ◆ Designer White/Kingswood Walnut | LDW1LKI1 |
| ◆ Designer White/Loft | LDW1LOFT |
| ◆ Designer White/Mahogany | LDW1N |
| ◆ Designer White/Mocha | LDW1MOCH |
| ◆ Designer White/Natural Maple | LDW1D |
| ◆ Designer White/Pinnacle | LDW1PINC |

TWO-TONE LAMINATE TOP / CHASSIS *continued*

| L1 LAMINATES | CODES |
|-----------------------------------|----------|
| Two-Tone Top/Chassis | |
| ◆ Designer White/Shaker Cherry | LDW1F |
| ◆ Designer White/Sterling Ash | LDW1LSA1 |
| ◆ Florence Walnut/Black | LFW1P |
| ◆ Florence Walnut/Charcoal | LFW1S |
| ◆ Florence Walnut/Designer White | LFW1LDW1 |
| ◆ Florence Walnut/Loft | LFW1LOFT |
| ◆ Harvest/Black | CP |
| ◆ Harvest/Charcoal | CS |
| ◆ Harvest/Designer White | CLDW1 |
| ◆ Harvest/Loft | CLOFT |
| ◆ Kingswood Walnut/Black | LKI1P |
| ◆ Kingswood Walnut/Charcoal | LKI1S |
| ◆ Kingswood Walnut/Designer White | LKI1LDW1 |
| ◆ Kingswood Walnut/Loft | LKI1LOFT |
| ◆ Loft/Black | LOFTP |
| ◆ Loft/Charcoal | LOFTS |
| ◆ Loft/Designer White | LOFTLDW1 |
| ◆ Mahogany/Black | NP |
| ◆ Mahogany/Charcoal | NS |
| ◆ Mahogany/Designer White | NLDW1 |
| ◆ Mahogany/Loft | NLOFT |
| ◆ Mocha/Black | MOCHP |
| ◆ Mocha/Charcoal | MOCHS |
| ◆ Mocha/Designer White | MOCHLDW1 |
| ◆ Mocha/Loft | MOCHLOFT |

TWO-TONE LAMINATE TOP / CHASSIS *continued*

| L1 LAMINATES | CODES |
|--------------------------------|----------|
| Two-Tone Top/Chassis | |
| ◆ Natural Maple/Black | DP |
| ◆ Natural Maple/Charcoal | DS |
| ◆ Natural Maple/Designer White | DLDW1 |
| ◆ Natural Maple/Loft | DLOFT |
| ◆ Pinnacle/Black | PINCP |
| ◆ Pinnacle/Charcoal | PINCS |
| ◆ Pinnacle/Designer White | PINCLDW1 |
| ◆ Pinnacle/Loft | PINCLOFT |
| ◆ Shaker Cherry/Black | FP |
| ◆ Shaker Cherry/Charcoal | FS |
| ◆ Shaker Cherry/Designer White | FLDW1 |
| ◆ Shaker Cherry/Loft | FLOFT |
| ◆ Sterling Ash/Black | LSA1P |
| ◆ Sterling Ash/Charcoal | LSA1S |
| ◆ Sterling Ash/Designer White | LSA1LDW1 |
| ◆ Sterling Ash/Loft | LSA1LOFT |

| L2 LAMINATES | CODES |
|---------------------------------|----------|
| Two-Tone Top/Chassis | |
| ◆ Designer White/Lowell Ash | LDWILLA1 |
| ◆ Designer White/Natural Recon | LDWILNR1 |
| ◆ Designer White/Phantom Ecru | LDW1PE1 |
| ◆ Designer White/Portico Teak | LDW1LPT1 |
| ◆ Designer White/Skyline Walnut | LDW1LSW1 |
| ◆ Lowell Ash/Black | LLA1P |
| ◆ Lowell Ash/Charcoal | LLA1S |
| ◆ Lowell Ash/Designer White | LLA1LDW1 |
| ◆ Lowell Ash/Loft | LLA1LOFT |
| ◆ Natural Recon/Black | LNR1P |
| ◆ Natural Recon/Charcoal | LNR1S |
| ◆ Natural Recon/Designer White | LNR1LDW1 |
| ◆ Natural Recon/Loft | LNR1LOFT |

TWO-TONE LAMINATE TOP / CHASSIS *continued*

| L2 LAMINATES | CODES |
|---------------------------------|----------|
| Two-Tone Top/Chassis | |
| ◆ Phantom Ecru/Black | LPE1P |
| ◆ Phantom Ecru/Charcoal | LPE1S |
| ◆ Phantom Ecru/Designer White | LPE1LDW1 |
| ◆ Phantom Ecru/Loft | LPE1LOFT |
| ◆ Portico Teak/Black | LPT1P |
| ◆ Portico Teak/Charcoal | LPT1S |
| ◆ Portico Teak/Designer White | LPT1LDW1 |
| ◆ Portico Teak/Loft | LPT1LOFT |
| ◆ Skyline Walnut/Black | LSW1P |
| ◆ Skyline Walnut/Charcoal | LSW1S |
| ◆ Skyline Walnut/Designer White | LSW1LDW1 |
| ◆ Skyline Walnut/Loft | LSW1LOFT |

HLAM3772RD, HLAM3348RR

EDGEBAND COLORS CODES

| Woodgrain | CODES |
|--------------------|-------|
| ◆ Bourbon Cherry | H |
| ◆ Cognac | COGN |
| ◆ Florence Walnut | FW |
| ◆ Harvest | C |
| ◆ Kingswood Walnut | KI |
| ◆ Lowell Ash | DL |
| ◆ Mahogany | N |
| ◆ Mocha | MOCH |
| ◆ Natural Maple | D |
| ◆ Natural Recon | NR |
| ◆ Phantom Ecru | PE |
| ◆ Pinnacle | PINC |
| ◆ Portico Teak | DP |
| ◆ Shaker Cherry | F |
| ◆ Skyline Walnut | SW |
| ◆ Sterling Ash | SA |

| Solid | CODES |
|------------------|-------|
| ◆ Black | P |
| ◆ Charcoal | S |
| ◆ Designer White | DW |
| ◆ Loft | LOFT |

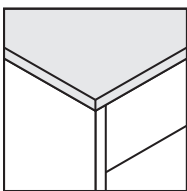

Laminate Chassis

Two-tone laminates: Top and edgebanding are the same, chassis is different laminate color.

The following 10500 Series™ products are not available as two-tone. They are one color and require only one color code:

- Modular pedestals — box/file, box/box/file, file/file, lateral file, multi file, and cabinet (also applies to Valido/11500 Series).
- Access strip and end panel kits
- Back enclosures
- Wall mounted open shelf
- Reception stations for return
- T-shaped end panels
- L-shaped end panels

Storage chassis that are specified in L2 laminates and are longer than 60" W will ship with back panels that are horizontal grain.

- Edgebanding on two-tone laminates matches top, chassis is a different laminate color.
- A complete selection of Conference Room and Occasional Tables is shown in the Tables section of the 2021 Shared Spaces Pricer.

LAMINATE DESKS

SPECIFY: Model Number.

Laminate

EXAMPLE: H10596.HP

- All specifications in this publication are based on the latest product information available at the time of print.

◆◆◆ For lead time information see page 19.

10500 SERIES™

Typicals



Icon Legend on page 19

Components used are listed on pages 274-325. Order components individually. Other configurations are possible, including various sizes of some components.

| QTY | DESCRIPTION | MODEL | LIST PRICE | PRICE EXTENSION |
|---------------|--|-----------|----------------|-----------------|
| 1 | Rectangle Worksurface 78"W x 30"D | H105R3078 | \$455 | \$455 |
| 1 | O-Leg 30"D x 28½"H | HLSL30280 | \$395 | \$395 |
| 1 | Low Credenza 72"W x 20"D x 21½"H, Drawers Right, Bookcase Left | H105975R | \$1,404 | \$1,404 |
| 1 | O-Leg Support over Low Credenza 30"D x 7"H | HLSL3070 | \$305 | \$305 |
| 1 | Multi-Use Stack-On Storage 36"W x 18"D x 45⅝"H | H105310 | \$1,123 | \$1,123 |
| TOTAL: | | | \$3,682 | |

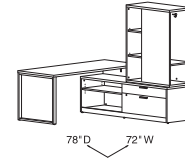

DESK L-WORKSTATION
72\"/>

| QTY | DESCRIPTION | MODEL | LIST PRICE | PRICE EXTENSION |
|---------------|--|------------|----------------|-----------------|
| 1 | Rectangle Worksurface 72"W x 30"D | H105R3072 | \$427 | \$427 |
| 1 | Modesty/Back Panels - Full Length 72"W x 27⅞"H | HNLMP7228 | \$314 | \$314 |
| 1 | Coordinate™ Height Adjustable Base | HHATB2S2LT | \$950 | \$950 |
| 2 | Shroud for Height Adjustable Base | HLAMSHB30 | \$899 | \$1,798 |
| 1 | Credenza with Doors 72"W x 24"D x 29½"H | H105909 | \$1,933 | \$1,933 |
| 1 | Stack-On Storage 72"W x 14⅝"D x 37⅞"H, 4 Doors | H10534 | \$1,072 | \$1,072 |
| 1 | External Stiffener 60"W for 72"W Worksurfaces | HLSLZ55C72 | \$119 | \$119 |
| TOTAL: | | | \$6,613 | |

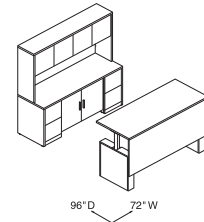

HEIGHT ADJUSTABLE TABLE
WORKSTATION WITH STACK-ON
STORAGE
72\"/>

| QTY | DESCRIPTION | MODEL | LIST PRICE | PRICE EXTENSION |
|---------------|--|---------|----------------|-----------------|
| 1 | Single Pedestal Desk, Left - B/F 66"W x 30"D x 29½"H | H10584L | \$1,102 | \$1,102 |
| 1 | Return, Right - B/F 42"W x 24"D x 29½"H | H10511R | \$869 | \$869 |
| 1 | Stack-on Storage 72"W x 14⅝"D x 37⅞"H | H10534 | \$1,072 | \$1,072 |
| TOTAL: | | | \$3,043 | |

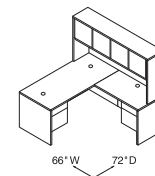

DESK "L" WORKSTATION - RIGHT
66\"/>

| QTY | DESCRIPTION | MODEL | LIST PRICE | PRICE EXTENSION |
|---------------|--|---------|----------------|-----------------|
| 1 | Double Full Pedestal Desk - 3/2 72"W x 36"D x 29½"H | H105890 | \$1,805 | \$1,805 |
| 1 | Credenza with Kneespace - 2/0/2 72"W x 24"D x 29½"H | H105900 | \$1,583 | \$1,583 |
| 1 | Stack-on Storage, Frosted Doors with Silver Frame 72"W x 14⅝"D x 37⅞"H | H10534G | \$1,759 | \$1,759 |
| TOTAL: | | | \$5,147 | |

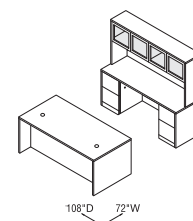

DESK/CREDENZA/STACK-ON STORAGE
WITH FROSTED DOORS
72\"/>



Icon Legend on page 19

10500 SERIES™ Typicals

DESKS

Components used are listed on pages 274-325. Order components individually. Other configurations are possible, including various sizes of some components.

| QTY | DESCRIPTION | MODEL | LIST PRICE | PRICE EXTENSION |
|---------------|---|----------------|----------------|-----------------|
| 1 | Storage/File Cabinet 18"W x 24"D x 66 $\frac{5}{8}$ "H, Hinged Right | H105297R | \$1,794 | \$1,794 |
| 1 | Open Credenza 36"W x 24"D x 21 $\frac{1}{2}$ "H | H105LCHAT3024S | \$234 | \$234 |
| 1 | Open/Lateral Credenza 30"W x 24"D x 21 $\frac{1}{2}$ "H | H105LC3024SF | \$520 | \$520 |
| 1 | Modular Credenza Top 60"W x 24"D | H105CTHAT6024L | \$724 | \$724 |
| 1 | Wall Mounted Open Hutch, Cubby w/Glass Doors 60"W x 14 $\frac{5}{8}$ "D x 20"H | H105WMH60PCG | \$1,761 | \$1,761 |
| 1 | Height Adjustable Base | HHATB3S2LT | \$1,047 | \$1,047 |
| 1 | External Stiffener 60"W for 72" Worksurface | HLSLZ5SC66 | \$110 | \$110 |
| 1 | Shroud for Height Adjustable Base 5 $\frac{1}{8}$ "W x 26"D x 26 $\frac{1}{4}$ "H | HLAMSHB30 | \$899 | \$899 |
| 1 | Rectangle Worksurface 66"W x 30"D | H105R3066 | \$397 | \$397 |
| 1 | Mixed Material Floating Modesty Panel 36"W x 14"H | HLSL3614MM | \$810 | \$810 |
| TOTAL: | | | \$8,296 | |

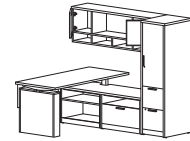

**HEIGHT ADJUSTABLE
"L" WORKSTATION**
66"W x 78"D

| QTY | DESCRIPTION | MODEL | LIST PRICE | PRICE EXTENSION |
|---------------|--|--------------|----------------|-----------------|
| 1 | H-Leg Support 30"W x 28 $\frac{3}{8}$ "H | H105HLEG3028 | \$374 | \$374 |
| 1 | Rectangle Worksurface 66"W x 30"D | H105R3066 | \$397 | \$397 |
| 1 | External Channel 54"W | HLSLZ5SC66 | \$110 | \$110 |
| 1 | Flat Bracket 24"D | HHN831124 | \$72 | \$72 |
| 1 | Return Shell w/Full Modesty Panel 72"W x 24"D x 29 $\frac{1}{2}$ "H | H105686 | \$738 | \$738 |
| 1 | Multi File Pedestal, Floor-Standing 36"W x 20"D x 28"H | H10505 | \$1,324 | \$1,324 |
| 1 | Personal Storage Tower, Hinged Right 24"W x 24"D x 66 $\frac{5}{8}$ "H | H105301R | \$2,268 | \$2,268 |
| 1 | Wall Mounted Open Hutch 72"W x 14 $\frac{5}{8}$ "D x 15"H | H105WMH72P | \$1,484 | \$1,484 |
| 1 | Laminate Floating Modesty Panel 54"W x 14"H | HLSL5414L | \$258 | \$258 |
| TOTAL: | | | \$7,025 | |

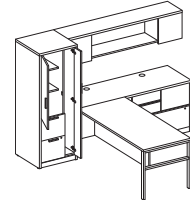

**EXTENDED STORAGE
"L" WORKSTATION**
66"W x 96"D

| QTY | DESCRIPTION | MODEL | LIST PRICE | PRICE EXTENSION |
|---------------|---|----------|----------------|-----------------|
| 1 | Single Full Pedestal Desk, Right - B/B/F 72"W x 36"D x 29 $\frac{1}{2}$ "H | H105895R | \$1,443 | \$1,443 |
| 1 | Bridge 47"W x 24"D x 29 $\frac{1}{2}$ "H | H10570 | \$386 | \$386 |
| 1 | Single Full Pedestal Credenza, Left - F/F 72"W x 24"D x 29 $\frac{1}{2}$ "H | H105904L | \$1,283 | \$1,283 |
| 1 | Stack-on Storage 72"W x 14 $\frac{5}{8}$ "D x 37 $\frac{1}{8}$ "H | H10534 | \$1,072 | \$1,072 |
| TOTAL: | | | \$4,184 | |

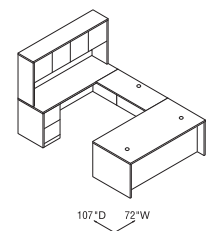

**"U" WORKSTATION
WITH FULL PEDESTALS**
72"W x 107"D

10500 SERIES™

Typicals



Icon Legend on page 19

Components used are listed on pages 274-325. Order components individually. Other configurations are possible, including various sizes of some components.

| QTY | DESCRIPTION | MODEL | LIST PRICE | PRICE EXTENSION |
|---------------|---|----------|----------------|-----------------|
| 1 | Rudder Peninsula with End Panel, Right 72"W x 30/38"D x 29½"H | H105205R | \$1,180 | \$1,180 |
| 1 | Return, Left - F/F 42"W x 24"D x 29½"H | H105908L | \$998 | \$998 |
| 1 | Stack-on Storage 72"W x 14⅝"D x 37⅞"H | H10534 | \$1,072 | \$1,072 |
| TOTAL: | | | \$3,250 | |

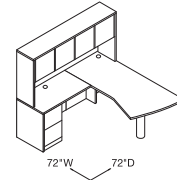

PENINSULA "L" WORKSTATION

72" W x 72" D

| QTY | DESCRIPTION | MODEL | LIST PRICE | PRICE EXTENSION |
|---------------|--|----------|----------------|-----------------|
| 1 | Peninsula with End Panel 72"W x 36"D x 29½"H | H10521 | \$930 | \$930 |
| 1 | Bridge 42"W x 24"D x 29½"H | H10560 | \$371 | \$371 |
| 1 | Extended Corner Unit, Left 72"W x 24"-36"D x 29½"H | H105816L | \$1,139 | \$1,139 |
| 1 | Mobile Pedestal - B/B/F 15¾"W x 22¾"D x 28"H | H105102 | \$906 | \$906 |
| 1 | Stack-on Storage 72"W x 14⅝"D x 37⅞"H | H10534 | \$1,072 | \$1,072 |
| 1 | Storage Cabinet/Lateral File 36"W x 24"D x 66⅝"H | H105293 | \$2,415 | \$2,415 |
| TOTAL: | | | \$6,833 | |

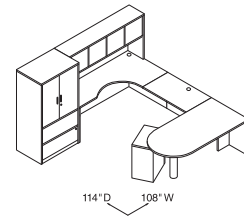

PENINSULA "U" WORKSTATION - LEFT

108" W x 114" D

| QTY | DESCRIPTION | MODEL | LIST PRICE | PRICE EXTENSION |
|---------------|---|----------------|----------------|-----------------|
| 1 | Slide Out Tower, Left Hinged 12"W x 24"D x 50"H | H105ST122450L | \$2,868 | \$2,868 |
| 1 | Open Credenza 30"W x 24"D x 21½"H | H105LCHAT3024S | \$234 | \$234 |
| 1 | Open/Lateral Credenza 30"W x 24"D x 21½"H | H105LC3024SF | \$520 | \$520 |
| 1 | Modular Credenza Top 60"W x 24"D | H105CTHAT6024R | \$724 | \$724 |
| 1 | Height Adjustable Base | HHATB3S2LT | \$1,047 | \$1,047 |
| 1 | External Stiffener 60"W for 72" Worksurface | HL5LZ5SC66 | \$110 | \$110 |
| 1 | Shroud for Height Adjustable Base 5⅞"W x 26"D x 26¼"H | HLAMSHB30 | \$899 | \$899 |
| 1 | Rectangle Worksurface 66"W x 30"D | H105R3066 | \$397 | \$397 |
| 1 | Laminate Floating Modesty Panel 30"W x 14"H | HL5L3014L | \$191 | \$191 |
| 1 | 2-Drawer Credenza 30"W x 24"D x 21½"H | H105LC3024BF | \$590 | \$590 |
| 1 | Modular Credenza Top 30"W x 24"D | H105CT3024 | \$419 | \$419 |
| 1 | Fabric Credenza Top 30"W x 24"D | HLAMSEAT3024 | \$430 | \$430 |
| TOTAL: | | | \$8,429 | |

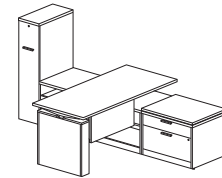

**HEIGHT ADJUSTABLE "L" WORKSTATION
WITH SLIDE OUT STORAGE**

66" W x 102" D



Icon Legend on page 19

10500 SERIES™ Bundles Typicals

Mahogany
H105LL7284N

Harvest
H105LL7284C

| QTY | DESCRIPTION | MODEL | LIST PRICE | PRICE EXTENSION |
|---------------|--------------------|---------|----------------|-----------------|
| 1 | Left Pedestal Desk | H10586L | \$1,253 | \$1,253 |
| 1 | Right Return | H10515R | \$888 | \$888 |
| TOTAL: | | | \$2,141 | |

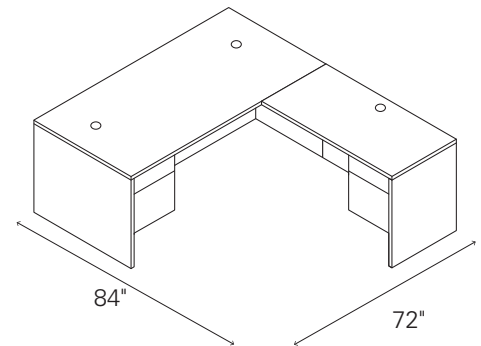

L-STATION (LEFT DESK/RIGHT RETURN)

Mahogany
H105LR7284N

Harvest
H105LR7284C

| QTY | DESCRIPTION | MODEL | LIST PRICE | PRICE EXTENSION |
|---------------|---------------------|---------|----------------|-----------------|
| 1 | Right Pedestal Desk | H10585R | \$1,253 | \$1,253 |
| 1 | Left Return | H10516L | \$888 | \$888 |
| TOTAL: | | | \$2,141 | |

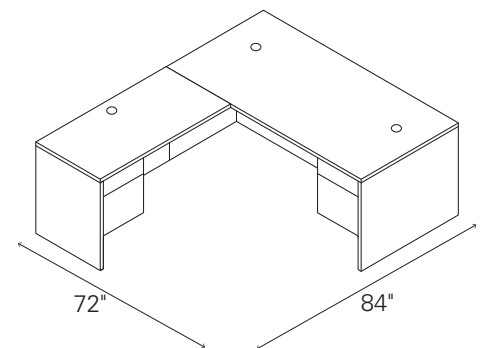

L-STATION (RIGHT DESK/LEFT RETURN)

Mahogany
H105LLH7284N

Harvest
H105LLH7284C

| QTY | DESCRIPTION | MODEL | LIST PRICE | PRICE EXTENSION |
|---------------|--------------------|---------|----------------|-----------------|
| 1 | Left Pedestal Desk | H10586L | \$1,253 | \$1,253 |
| 1 | Right Return | H10515R | \$888 | \$888 |
| 1 | Stack-on Storage | H105323 | \$901 | \$901 |
| TOTAL: | | | \$3,042 | |

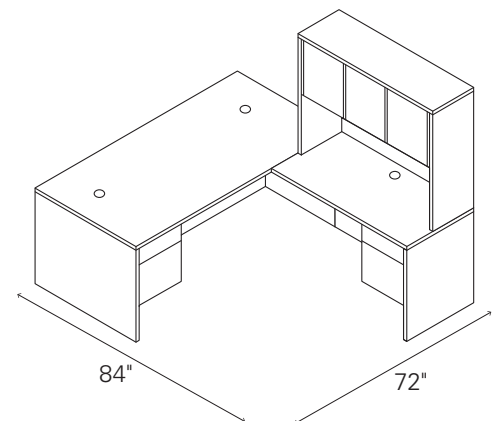

**L-STATION WITH STACK-ON STORAGE
(LEFT DESK/RIGHT RETURN)**

10500 SERIES™

Bundles Typicals



Icon Legend on page 19

Mahogany
H105LRH7284N

Harvest
H105LRH7284C

| QTY | DESCRIPTION | MODEL | LIST PRICE | PRICE EXTENSION |
|---------------|---------------------|---------|----------------|-----------------|
| 1 | Right Pedestal Desk | H10585R | \$1,253 | \$1,253 |
| 1 | Left Return | H10516L | \$888 | \$888 |
| 1 | Stack-on Storage | H105323 | \$901 | \$901 |
| TOTAL: | | | \$3,042 | |

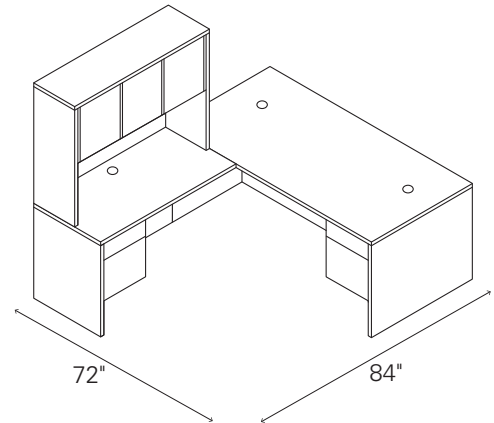

**L-STATION WITH STACK-ON STORAGE
(RIGHT DESK/LEFT RETURN)**

Mahogany
H105ULH72108N

Harvest
H105ULH72108C

| QTY | DESCRIPTION | MODEL | LIST PRICE | PRICE EXTENSION |
|---------------|-------------------------|---------|----------------|-----------------|
| 1 | Left Pedestal Desk | H10586L | \$1,253 | \$1,253 |
| 1 | Right Pedestal Credenza | H10545R | \$1,085 | \$1,085 |
| 1 | Bridge | H10570 | \$386 | \$386 |
| 1 | Stack-on Storage | H10534 | \$1,072 | \$1,072 |
| TOTAL: | | | \$3,796 | |

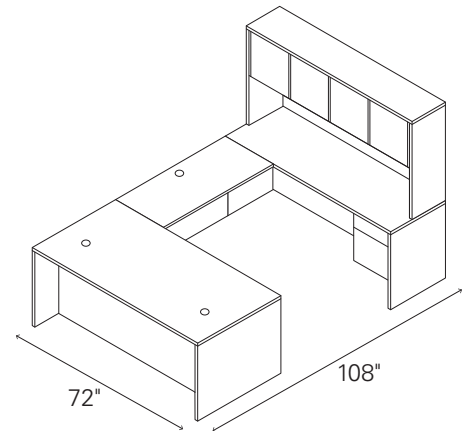

**U-STATION WITH STACK-ON STORAGE
(LEFT DESK/RIGHT CREDENZA)**

Mahogany
H105URH72108N

Harvest
H105URH72108C

| QTY | DESCRIPTION | MODEL | LIST PRICE | PRICE EXTENSION |
|---------------|------------------------|---------|----------------|-----------------|
| 1 | Right Pedestal Desk | H10585R | \$1,253 | \$1,253 |
| 1 | Left Pedestal Credenza | H10546L | \$1,085 | \$1,085 |
| 1 | Bridge | H10570 | \$386 | \$386 |
| 1 | Stack-on Storage | H10534 | \$1,072 | \$1,072 |
| TOTAL: | | | \$3,796 | |

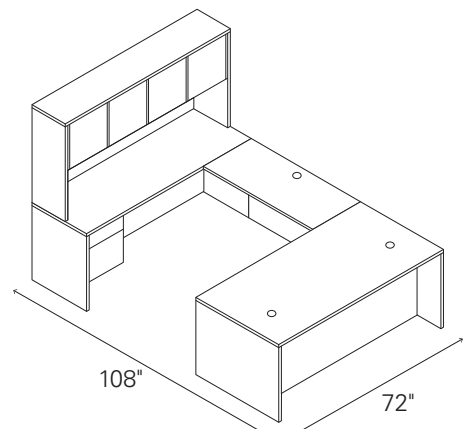

**U-STATION WITH STACK-ON STORAGE
(RIGHT DESK/LEFT CREDENZA)**



Icon Legend on page 19

10500 SERIES™ Bundles Typicals

DESKS

Mahogany
H105DLH7298N

Harvest
H105DLH7298C

| QTY | DESCRIPTION | MODEL | LIST PRICE | PRICE EXTENSION |
|---------------|----------------------------|---------|----------------|-----------------|
| 1 | Double Pedestal Desk | H10593 | \$1,475 | \$1,475 |
| 2 | Bookcase Hutch | H105292 | \$605 | \$1,210 |
| 1 | 2-Drawer Lateral File | H10563 | \$1,032 | \$1,032 |
| 1 | Storage Cabinet with Doors | H105291 | \$828 | \$828 |
| TOTAL: | | | \$4,545 | |

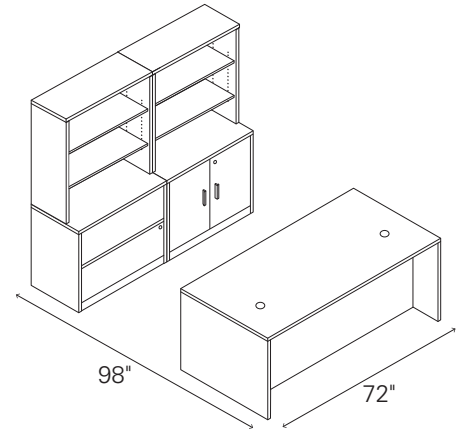

STORAGE WORKSTATION

Mahogany
H105DCH6098N

Harvest
H105DCH6098C

| QTY | DESCRIPTION | MODEL | LIST PRICE | PRICE EXTENSION |
|---------------|--------------------------|---------|----------------|-----------------|
| 1 | Double Pedestal Desk | H10573 | \$1,243 | \$1,243 |
| 1 | Double Pedestal Credenza | H10565 | \$1,243 | \$1,243 |
| 1 | Stack-on Storage | H105324 | \$1,000 | \$1,000 |
| TOTAL: | | | \$3,486 | |

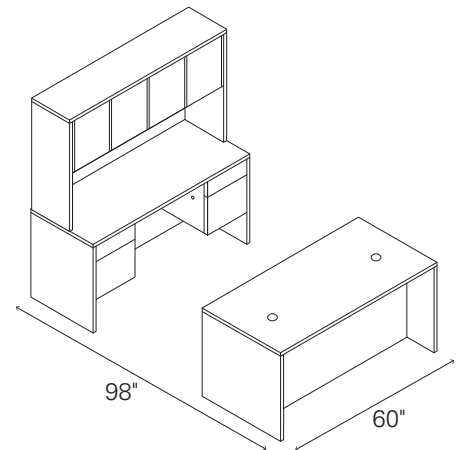

DESK CREDENZA STACK-ON #1

Mahogany
H105DCH7298N

Harvest
H105DCH7298C

| QTY | DESCRIPTION | MODEL | LIST PRICE | PRICE EXTENSION |
|---------------|--------------------------|--------|----------------|-----------------|
| 1 | Double Pedestal Desk | H10593 | \$1,475 | \$1,475 |
| 1 | Double Pedestal Credenza | H10543 | \$1,315 | \$1,315 |
| 1 | Stack-on Storage | H10534 | \$1,072 | \$1,072 |
| TOTAL: | | | \$3,862 | |

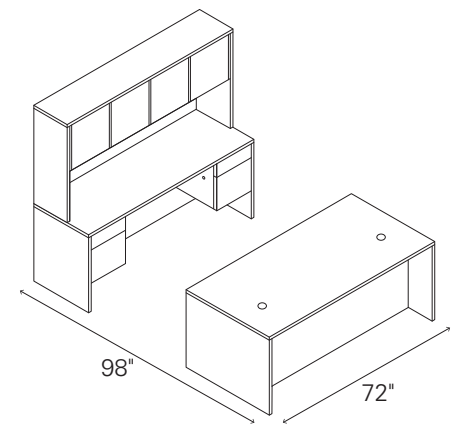

DESK CREDENZA STACK-ON #2

10500 SERIES™ Laminate Modular Components

GSA SIN 33721



Icon Legend on page 19

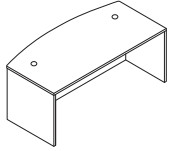

Model H10596 shown

| DESCRIPTION | INSIDE DIMENSIONS | FULL WIDTH OVERHANG | MODEL | SHIP WEIGHT | CUBE | LIST PRICE BY LAMINATE GRADE | |
|--|-------------------|---------------------|---------|-------------|------|------------------------------|-------|
| | | | | | | L1 | L2 |
| Desk Shell (with full modesty panel and 2 grommets) | | | | | | | |
| 72"W x 36"D x 29½"H, Bow Top (end panels 30"D) | 69½"W x 24⅝"D | 10½" | H10596 | 192 | 6.9 | \$948 | \$998 |
| 72"W x 36"D x 29½"H, Rectangle Top | 69½"W x 24⅝"D | 10½" | H10594 | 209 | 6.9 | \$856 | \$906 |
| 72"W x 30"D x 29½"H, Rectangle Top | 69½"W x 24⅝"D | 4½" | H10592 | 182 | 5.8 | \$811 | \$851 |
| 66"W x 30"D x 29½"H, Rectangle Top | 63½"W x 24⅝"D | 4½" | H10579 | 172 | 5.4 | \$769 | \$809 |
| 60"W x 30"D x 29½"H, Rectangle Top | 57½"W x 24⅝"D | 4½" | H10578 | 161 | 5.0 | \$715 | \$755 |
| 48"W x 30"D x 29½"H, Rectangle Top (1 grommet) | 45½"W x 24⅝"D | 4½" | H10598 | 141 | 5.0 | \$664 | \$694 |
| NOTES: See page 325 for optional center drawers. | | | | | | | |
| Desk Shell (with 10"H modesty panel and 2 grommets) | | | | | | | |
| 72"W x 36"D x 29½"H, Bow Top (end panels 30"D) | 69½"W x 24⅝"D | 10½" | H10596X | 155 | 6.1 | \$948 | \$998 |
| 72"W x 36"D x 29½"H, Rectangle Top | 69½"W x 24⅝"D | 10½" | H10594X | 153 | 6.1 | \$856 | \$906 |
| 72"W x 30"D x 29½"H, Rectangle Top | 69½"W x 24⅝"D | 4½" | H10592X | 143 | 5.1 | \$811 | \$851 |
| 66"W x 30"D x 29½"H, Rectangle Top | 63½"W x 24⅝"D | 4½" | H10579X | 134 | 4.7 | \$769 | \$809 |
| 60"W x 30"D x 29½"H, Rectangle Top | 57½"W x 24⅝"D | 4½" | H10578X | 125 | 4.4 | \$715 | \$755 |
| 48"W x 30"D x 29½"H, Rectangle Top (1 grommet) | 45½"W x 24⅝"D | 4½" | H10598X | 115 | 4.4 | \$664 | \$694 |
| NOTES: Makes reaching wall electrical outlets quick and easy. Provides more than 18" of clearance. See pages 302-303 for optional stack-on storage and page 325 for optional center drawers. | | | | | | | |

NOTES:

- Non-handed desk, credenza, and return shells, combined with a variety of under-the-worksurface storage solutions, maximize office layout flexibility. Products can be reconfigured quickly and easily when user preferences or space needs change.
- For under-surface storage options, see pages 289-291.
- For additional components see pages 298-325.
- Tops and end panels are abrasion- and stain-resistant laminate over durable 1⅞" solid core high-performance particleboard; resists warping.
- Cord management grommets, for routing and hiding wires and cables, are located in the tops of desks and return shells.
- 3" round worksurface grommet can be replaced with optional Power Hub (model HGRMTAC) or Power/USB Hub (model HGRMTUSB2) to bring the ease of plug-and-play to the desktop. See page 324.
- Adjustable hex leveling glides allow floor-standing furniture to be easily leveled without lifting the unit; glides have ¾" adjustable range.
- For standing, 42"H shells, see page 277.

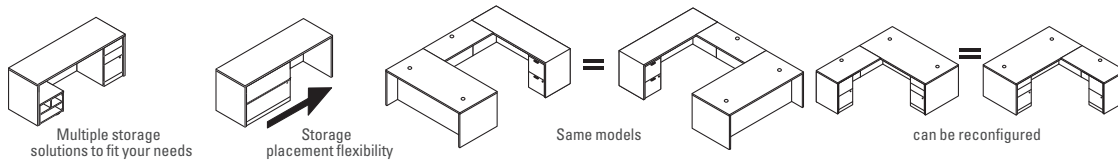

HOW TO SPECIFY

| | |
|--|---|
| <p>Select Model Number</p> <p>H 1 0 5 9 6 .</p> | <p>Select Laminate Top and Chassis Color</p> <p>See pages 266-267</p> <p>N N</p> |
|--|---|



Icon Legend on page 19

10500 SERIES™

Laminate Modular Components

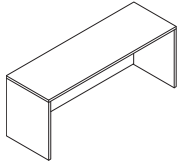

| DESCRIPTION | INSIDE DIMENSIONS | MODEL | SHIP WEIGHT | CUBE | LIST PRICE BY LAMINATE GRADE | |
|---|-------------------|----------------|-------------|------|------------------------------|--------------|
| | | | | | L1 | L2 |
| Credenza Shell (with full modesty panel) | | | | | | |
| 72"W x 24"D x 29½"H | 69½"W x 22¾"D | H10541 | 153 | 5.6 | \$738 | \$778 |
| 66"W x 24"D x 29½"H | 63½"W x 22¾"D | H10542 | 144 | 5.1 | \$722 | \$762 |
| 60"W x 24"D x 29½"H | 57½"W x 22¾"D | H10564 | 135 | 4.7 | \$676 | \$711 |
| 48"W x 24"D x 29½"H | 45½"W x 22¾"D | H105692 | 124 | 3.9 | \$647 | \$677 |
| 42¼"W x 24"D x 29½"H | 39¾"W x 22¾"D | H105691 | 110 | 3.8 | \$626 | \$656 |
| | | | | | | |
| 72"W x 20"D x 29½"H | 69½"W x 18¾"D | H105581 | 138 | 5.6 | \$697 | \$732 |
| 66"W x 20"D x 29½"H | 63½"W x 18¾"D | H105582 | 130 | 5.1 | \$680 | \$715 |
| 60"W x 20"D x 29½"H | 57½"W x 18¾"D | H105583 | 122 | 4.7 | \$645 | \$675 |

NOTES: Cord pass-through in top center of modesty panel. See pages 302-303 for optional stack-on storage.

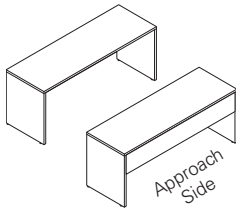

| DESCRIPTION | INSIDE DIMENSIONS | MODEL | SHIP WEIGHT | CUBE | LIST PRICE BY LAMINATE GRADE | |
|--|-------------------|-----------------|-------------|------|------------------------------|--------------|
| | | | | | L1 | L2 |
| Credenza Shell (with 10" H modesty panel) | | | | | | |
| 72"W x 24"D x 29½"H | 69½"W x 22¾"D | H10541X | 114 | 4.8 | \$738 | \$778 |
| 66"W x 24"D x 29½"H | 63½"W x 22¾"D | H10542X | 107 | 4.4 | \$722 | \$762 |
| 60"W x 24"D x 29½"H | 57½"W x 22¾"D | H10564X | 105 | 4.0 | \$676 | \$711 |
| 48"W x 24"D x 29½"H | 45½"W x 22¾"D | H105692X | 95 | 3.8 | \$647 | \$677 |
| 42¼"W x 24"D x 29½"H | 39¾"W x 22¾"D | H105691X | 87 | 3.8 | \$626 | \$656 |
| | | | | | | |
| 72"W x 20"D x 29½"H | 69½"W x 18¾"D | H105581X | 107 | 4.8 | \$697 | \$732 |
| 66"W x 20"D x 29½"H | 63½"W x 18¾"D | H105582X | 101 | 4.4 | \$680 | \$715 |
| 60"W x 20"D x 29½"H | 57½"W x 18¾"D | H105583X | 96 | 4.0 | \$645 | \$675 |

NOTES: Makes reaching wall electrical outlets quick and easy. Provides more than 18" of clearance. See pages 302-303 for optional stack-on storage.



Not available in two-tone laminate

| DESCRIPTION | MODEL | SHIP WEIGHT | CUBE | L1 | L2 |
|---|----------------|-------------|------|--------------|--------------|
| | | | | LIST PRICE | LIST PRICE |
| Kneespace Clearance End Panel Kits (field installable) | | | | | |
| 1½"W x 11¼"D x 28½"H | H105098 | 13 | 0.9 | \$223 | \$233 |
| For use at either end of 10500, 10700 or Valido Series® 24"D Credenza Shells (with full or 10" modesty panel) or non-pedestal end of single pedestal credenzas or credenzas with lateral files. | | | | | |
| 1½"W x 17¼"D x 28½"H | H105099 | 11 | 0.8 | \$234 | \$244 |
| For use at either end of 10500, 10700 or Valido Series® 30"D Desk Shells or non-pedestal end of 30"D single pedestal desks. | | | | | |
| Kits include: (1) support panel; European fastening hardware; flat connector bracket; joint connector bolts with sleeve nuts (for ganging credenza to adjacent worksurface); and adjustable leveling glides. Allows conversion of units currently in the field. | | | | | |
| NOTES: Can be used to connect up to three 24"D credenzas or 30"D desks in line (requires 4 kits). | | | | | |
| ⚠ Not designed to be used freestanding. Not designed to be used with returns, 36"D desks or desk shells. | | | | | |
| SPECIFYING EXAMPLE: H105098.N | | | | | |

NOTES:

- Non-handed desk, credenza, and return shells, combined with a variety of under-the-worksurface storage solutions, maximize office layout flexibility. Products can be reconfigured quickly and easily when user preferences or space needs change.
- For 78", 84", 90", and 96"W credenza shells, see page 276.
- For under-surface storage options, see pages 289-291.
- Tops and end panels are abrasion- and stain-resistant laminate over durable 1/8" solid core high-performance particleboard; resists warping.
- For additional components see pages 298-325.
- For work-in-process paper management tools, see pages 319-320.
- Cord management grommets, for routing and hiding wires and cables, are located in the tops of desks and return shells.
- Credenza shells have a cord pass-through grommet in the top center of the modesty panel.
- Kneespace Clearance End Panel Kit model H105098, can be used to create "L" configurations with leg clearance, by connecting credenzas to single pedestal desks or credenzas, desk or credenza shells, corners, extended corners or peninsulas.
- Adjustable hex leveling glides allow floor-standing furniture to be easily leveled without lifting the unit; glides have 3/4" adjustable range.

HOW TO SPECIFY

| | |
|---|--|
| Select Model Number <input type="text" value="H10541"/> | Select Laminate Top and Chassis Color See pages 266-267 <input type="text" value="NN"/> |
|---|--|

10500 SERIES™

Laminate Modular Components

GSA SIN 33721



Icon Legend on page 19

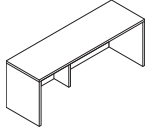

| DESCRIPTION | INSIDE DIMENSIONS | MODEL | SHIP WEIGHT | CUBE | LIST PRICE BY LAMINATE GRADE | |
|---|-------------------|----------------|-------------|------|------------------------------|---------------|
| | | | | | L1 | L2 |
| Credenza Shell (with full modesty panel) | | | | | | |
| 96"W x 24"D x 29½"H | 93½"W x 22¾"D | H105413 | 215 | 7.0 | \$1051 | \$1106 |
| 90"W x 24"D x 29½"H | 87½"W x 22¾"D | H105412 | 202 | 6.6 | \$1022 | \$1072 |
| 84"W x 24"D x 29½"H | 81½"W x 22¾"D | H105411 | 189 | 6.2 | \$907 | \$957 |
| 78"W x 24"D x 29½"H | 75½"W x 22¾"D | H105410 | 176 | 5.8 | \$882 | \$927 |

NOTES: Larger sizes can be used in conjunction with a 10500 Series rectangle- or bullet-shaped worksurface, supported by an end panel, column or leg, to achieve a space efficient work wall configuration. Shells wider than 72" include an internal, 10½"D vertical support leg. The internal leg can be removed if it is replaced with a 10500 Series 28"H modular pedestal that is adjusted to support the credenza shell top. Cord pass-through in top center of modesty panel. See pages 302-303 for optional stack-on storage and the stack-on storage end panel kit (model H105349).

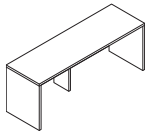

| | | | | | | |
|---|---------------|-----------------|-----|-----|---------------|---------------|
| Credenza Shell (with 10"H modesty panel) | | | | | | |
| 96"W x 24"D x 29½"H | 93½"W x 22¾"D | H105413X | 163 | 6.1 | \$1051 | \$1106 |
| 90"W x 24"D x 29½"H | 87½"W x 22¾"D | H105412X | 152 | 5.7 | \$1022 | \$1072 |
| 84"W x 24"D x 29½"H | 81½"W x 22¾"D | H105411X | 141 | 5.4 | \$907 | \$957 |
| 78"W x 24"D x 29½"H | 75½"W x 22¾"D | H105410X | 130 | 5.0 | \$882 | \$927 |

NOTES: Makes reaching wall electrical outlets quick and easy. Provides more than 18" of clearance. Larger sizes can be used in conjunction with a 10500 Series rectangle- or bullet-shaped worksurface, supported by an end panel, column or leg, to achieve a space efficient work wall configuration. Shells wider than 72" include an internal, 10½"D vertical support leg. The internal leg can be removed if it is replaced with a 10500 Series 28"H modular pedestal that is adjusted to support the credenza shell top. See pages 302-303 for optional stack-on storage and the stack-on storage end panel kit (model H105349).

NOTES:

- Non-handed desk, credenza, and return shells, combined with a variety of under-the-worksurface storage solutions, maximize office layout flexibility. Products can be reconfigured quickly and easily when user preferences or space needs change.
- For under-surface storage options, see pages 289-291.
- For additional components see pages 298-325.
- Tops and end panels are abrasion- and stain-resistant laminate over durable 1½" solid core high-performance particleboard; resists warping.
- Credenza shells have a cord pass-through grommet in the top center of the modesty panel.
- Kneespace Clearance End Panel Kit model H105098, can be used to create "L" configurations with leg clearance, by connecting credenzas to single pedestal desks or credenzas, desk or credenza shells, corners, extended corners or peninsulas.
- Adjustable hex leveling glides allow floor-standing furniture to be easily leveled without lifting the unit; glides have ¾" adjustable range.

HOW TO SPECIFY

Select
Model Number

H 1 0 5 4 1 3 .

Select
Laminate Top and Chassis Color

See pages 266-267

N N



10500 SERIES™

Laminate Modular Components

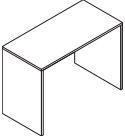
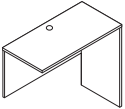
| | DESCRIPTION | INSIDE DIMENSIONS | MODEL | SHIP WEIGHT | CUBE | LIST PRICE BY LAMINATE GRADE | |
|---|---|-----------------------|----------------|-------------|------|------------------------------|--------------|
| | | | | | | L1 | L2 |
|  | Standing-Height Desk Shell | | | | | | |
| | 60"W x 30"D x 42"H | 57½"W x 24½"D x 41⅝"H | H105397 | 185 | 6.2 | \$888 | \$928 |
| | 60"W x 24"D x 42"H | 57½"W x 22¾"D x 41⅝"H | H105393 | 154 | 5.1 | \$819 | \$859 |
| | 48"W x 24"D x 42"H | 45⅞"W x 22¾"D x 41⅝"H | H105392 | 143 | 4.2 | \$766 | \$801 |
| | NOTES: Fixed height surface is 42"H. When combined with a stool-height task chair, provides users the benefit of alternating their work between a seated or standing position without the additional cost of an adjustable-height mechanism. Short, 22⅝" modesty panel provides over 18" of wall access; makes reaching wall electrical outlets quick and easy. Box/File Pedestal (H10501) attaches to the underside of the worksurface top to position supplies and files within easy reach. | | | | | | |
|  | Standing-Height Return Shell | | | | | | |
| | 48"W x 24"D x 42"H | 47"W x 22¾"D x 41⅝"H | H105663 | 96 | 3.1 | \$643 | \$678 |
| | NOTES: Non-handed design. Attaches to sit/stand desk shells to form an L-shaped workstation. Short, 22⅝" modesty panel makes reaching wall electrical outlets quick and easy. One cord management grommet in top for routing and hiding wires and cables. Grommet can be replaced with optional Power Hub (model HGRMTAC). Box/File Pedestal (H10501) attaches to the underside of the worksurface top to position supplies and files within easy reach. | | | | | | |

NOTES:

- 42"H shells help support a healthy work style by allowing users to switch between sitting and standing.
- Non-handed desk and return shells maximize office layout flexibility. Products can be reconfigured quickly and easily when user preferences or space needs change.
- Tops and end panels are abrasion- and stain-resistant laminate over durable 1⅝" solid core high-performance particleboard; resists warping.
- For additional components see pages 298-325.
- Mobile pedestals, shown on page 311, work well in a variety of applications and configurations.
- Adjustable hex leveling glides allow floor-standing furniture to be easily leveled without lifting the unit; glides have ¾" adjustable range.

HOW TO SPECIFY

| | |
|---|--|
| Select Model Number H 1 0 5 3 9 7 | Select Laminate Top and Chassis Color See pages 266-267 N N |
|---|--|

10500 SERIES™ Laminate Modular Components

GSA SIN 33721



Icon Legend on page 19

Model H105686 shown

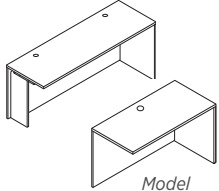

Model H105686 shown

| DESCRIPTION | INSIDE DIMENSIONS | MODEL | SHIP WEIGHT | CUBE | LIST PRICE BY LAMINATE GRADE | |
|---|-------------------|----------------|-------------|------|------------------------------|--------------|
| | | | | | L1 | L2 |
| Return Shell (with full modesty panel) | | | | | | |
| 72"W x 24"D x 29½"H, (w/support; 2 grommets) | 67"W x 22¾"D | H105686 | 145 | 5.4 | \$738 | \$778 |
| 60"W x 24"D x 29½"H, (w/support; 2 grommets) | 55"W x 22¾"D | H105684 | 129 | 4.4 | \$676 | \$711 |
| 48"W x 24"D x 29½"H, (1 grommet) | 47"W x 22¾"D | H10561 | 86 | 3.7 | \$556 | \$586 |
| 42"W x 24"D x 29½"H, (1 grommet) | 41"W x 22¾"D | H105681 | 89 | 2.5 | \$522 | \$552 |
| 36"W x 24"D x 29½"H, (1 grommet) | 34⅞"W x 22¾"D | H105680 | 83 | 3.2 | \$522 | \$547 |
| 30"W x 24"D x 29½"H, (1 grommet) | 28⅞"W x 22¾"D | H10568 | 69 | 2.6 | \$499 | \$524 |

NOTES: Shells are non-handed. No pre-drilled grommet in modesty panel (field installable grommet included). Woodgrain direction on modesty/back panel runs vertical on 30"W-60"W sizes and horizontal on 72"W unit. 36"W return shell can be used to achieve a 6' x 6' L-shaped footprint when connected to either a 72"W x 36"D single pedestal desk, desk shell, or peninsula, or when two are connected to 36"W corner unit model H105811. 30"W return shell can be used to accomplish a 5' x 5' L-shaped footprint when connected to a 60"W x 30"D desk shell or peninsula. See pages 302-303 for optional stack-on storage.

⚠ Not designed to attach to corner units manufactured prior to 5/24/99.

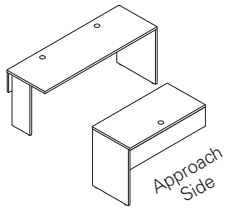

| | | | | | | |
|---|---------------|-----------------|-----|-----|--------------|--------------|
| Return Shell (with 10"H modesty panel) | | | | | | |
| 72"W x 24"D x 29½"H, (w/support; 2 grommets) | 67"W x 22¾"D | H105686X | 106 | 4.6 | \$738 | \$778 |
| 60"W x 24"D x 29½"H, (w/support; 2 grommets) | 55"W x 22¾"D | H105684X | 93 | 3.9 | \$676 | \$711 |
| 48"W x 24"D x 29½"H, (1 grommet) | 47"W x 22¾"D | H10561X | 78 | 3.1 | \$556 | \$586 |
| 42"W x 24"D x 29½"H, (1 grommet) | 41"W x 22¾"D | H105681X | 69 | 3.8 | \$522 | \$552 |
| 36"W x 24"D x 29½"H, (1 grommet) | 34⅞"W x 22¾"D | H105680X | 67 | 3.8 | \$522 | \$547 |
| 30"W x 24"D x 29½"H, (1 grommet) | 28⅞"W x 22¾"D | H10568X | 56 | 2.6 | \$499 | \$524 |

NOTES: Makes reaching wall electrical outlets quick and easy. Provides more than 18" of clearance. See pages 302-303 for optional stack-on storage.

NOTES:

- Non-handed desk, credenza, and return shells, combined with a variety of under-the-worksurface storage solutions, maximize office layout flexibility. Products can be reconfigured quickly and easily when user preferences or space needs change.
- For additional components see pages 298-325.
- Tops and end panels are abrasion- and stain-resistant laminate over durable 1⅞" solid core high-performance particleboard; resists warping.
- Cord management grommets, for routing and hiding wires and cables, are located in the tops of desks and return shells.
- Adjustable hex leveling glides allow floor-standing furniture to be easily leveled without lifting the unit; glides have ¾" adjustable range.
- 36"W and 30"W return shells enable L-shaped layouts for smaller spaces.
- One cord management grommet in tops of Return Shell models, H10568 and H10568X, is used for routing and hiding wires and cables. The 3" round grommet can be replaced with optional Power Hub or Power/USB Hub — see page 324.

HOW TO SPECIFY

| | |
|---|--|
| <p>Select Model Number</p> <p>H 1 0 5 6 8 6 .</p> | <p>Select Laminate Top and Chassis Color</p> <p>See pages 266-267</p> <p>N N</p> |
|---|--|



Icon Legend on page 19

10500 SERIES™ Worksurfaces

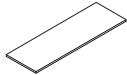
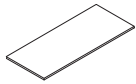

DESCRIPTION

Rectangle Worksurface

84"W x 30"D
78"W x 30"D
72"W x 30"D
66"W x 30"D
60"W x 30"D
48"W x 30"D

84"W x 24"D
78"W x 24"D
72"W x 24"D
66"W x 24"D
60"W x 24"D
48"W x 24"D
42"W x 24"D
36"W x 24"D
30"W x 24"D

| MODEL | SHIP WEIGHT | CUBE | LIST PRICE BY LAMINATE GRADE | |
|------------------|-------------|------|------------------------------|--------------|
| | | | L1 | L2 |
| H105R3084 | 88 | 6.5 | \$504 | \$529 |
| H105R3078 | 81 | 6.1 | \$455 | \$480 |
| H105R3072 | 83 | 6.1 | \$427 | \$447 |
| H105R3066 | 76 | 6.1 | \$397 | \$417 |
| H105R3060 | 69 | 5.2 | \$370 | \$390 |
| H105R3048 | 55 | 4.1 | \$304 | \$319 |
| H105R2484 | 70 | 5.3 | \$464 | \$489 |
| H105R2478 | 65 | 4.9 | \$413 | \$433 |
| H105R2472 | 66 | 4.9 | \$363 | \$383 |
| H105R2466 | 61 | 4.9 | \$351 | \$371 |
| H105R2460 | 55 | 4.2 | \$330 | \$350 |
| H105R2448 | 44 | 3.4 | \$280 | \$295 |
| H105R2442 | 39 | 3.0 | \$254 | \$269 |
| H105R2436 | 30 | 2.4 | \$220 | \$235 |
| H105R2430 | 25 | 2.0 | \$220 | \$235 |

NOTES: Underside of rectangle worksurfaces includes pilot mounting holes for end panels, support columns, post legs, H-legs, and O-legs, and height adjustable base. Applications for 24"D worksurfaces include desks, credenzas, returns, and bridges. For Above Privacy Screen sizes, see page 212.



Bullet Worksurface

72"W x 30"D
66"W x 30"D
60"W x 30"D

60"W x 24"D

| | | | | |
|------------------|----|-----|--------------|--------------|
| H105B3072 | 79 | 6.1 | \$443 | \$463 |
| H105B3066 | 73 | 6.1 | \$418 | \$438 |
| H105B3060 | 66 | 5.2 | \$399 | \$419 |
| H105B2460 | 45 | 4.2 | \$342 | \$357 |

NOTES: Applications include use as a peninsula in a U- or L-shaped workstation or as an island extension. One flat bracket (mounting plate) ships with each worksurface for applications requiring connection to an adjoining worksurface. Underside includes pilot mounting holes for T- and L-shaped end panels, H-leg, O-leg, support column, post leg, or flat bracket. Grain direction runs horizontal.

ⓘ When specifying 60"W Floating Modesty Panel, it is not necessary to specify an external channel.

DESCRIPTION

External Support Channel

42"W for a 54" Worksurface
48"W for a 60" Worksurface
54"W for a 66" Worksurface
60"W for a 72" Worksurface
72"W for an 84" Worksurface

ⓘ Available in Graphite paint only.

ⓘ When specifying panel-hung worksurfaces, specify external channel as if supported by two H-legs or O-legs via selection chart.

ⓘ When specifying a 54"W or 60"W Floating Modesty Panel, it is not necessary to specify an external channel.

MODEL

SHIP WEIGHT

CUBE

LIST PRICE

| | | | |
|---------------------|----|-----|--------------|
| HLSLZ5SC54 ⓘ | 5 | 0.5 | \$101 |
| HLSLZ5SC60 | 6 | 0.5 | \$106 |
| HLSLZ5SC66 | 7 | 0.5 | \$110 |
| HLSLZ5SC72 | 7 | 0.5 | \$119 |
| HLSLZ5SC84 | 12 | 0.7 | \$119 |

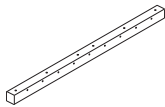

NOTES:

- Easy-care, scratch-, spill- and stain-resistant laminate over 1/8" solid core high-performance particleboard.
- Grain direction on all worksurfaces runs horizontal.
- One flat bracket (mounting plate) ships with each worksurface for applications requiring connection to an adjoining worksurface.
- For standing-height requirements, use worksurface with 41"H laminate L-shaped end panel or metal O-leg.
- For 30", 36", 42" and 48"W x 24"D mobile desks and tables, use post leg with casters model HMBPOST.C.
- For end panels, legs, columns and bases, see the Worksurface Supports listing on pages 280-281.
- When using a floating modesty panel or an external channel under the worksurface, the depth clearance for keyboard trays and center drawers decreases by 8". See accessory matrix in accessory section of the pricer.

ⓘ 84"W worksurfaces are for 29 1/2"H applications only (not 42"H) and require a T-support brace or other weight-bearing floor support to be positioned between the O-legs or L-shaped end panels.

ⓘ Worksurfaces are subject to slight bowing. The magnitude of the deflection is dependent upon the weight, placement, and duration of the load.

ⓘ When using a worksurface as a bridge, no additional supports are needed. One support is required for returns, two supports are required for desks and credenzas.

ⓘ External channel support is recommended for extended unsupported spans or heavily loaded worksurfaces. See above for details.

| EXTERNAL SUPPORT CHANNEL (Model HLSLZ5SCxx) — RECOMMENDED USE | | | | | | | |
|---|---------------------|----------------------------|-----------------------------|-----|-----|-----|-----|
| | Support Combination | | Rectangle Worksurface Width | | | | |
| | Support 1 | Support 2 | 60" | 66" | 72" | 78" | 84" |
| O-Leg | O-Leg | O-Leg | 66 | 72 | 78 | 84 | NA |
| | O-Leg | 4 1/2" Dia. Support Column | NR | 60 | 66 | 72 | 78 |
| | O-Leg | 2" Square Post Leg | NR | 60 | 66 | 72 | 78 |
| L-Shaped End Panel | L End Panel | L End Panel | NR | 60 | 66 | 72 | 78 |
| | L End Panel | O-Leg | 60 | 66 | 72 | 78 | 84 |
| | L End Panel | 4 1/2" Dia. Support Column | NR | 60 | 66 | 72 | 78 |
| | L End Panel | 2" Square Post Leg | NR | 60 | 66 | 72 | 78 |
| T-Shaped End Panel | T End Panel | O-Leg | 60 | 66 | 72 | 78 | 84 |
| | T End Panel | 4 1/2" Dia. Support Column | NR | 60 | 66 | 72 | 78 |
| | T End Panel | 2" Square Post Leg | NR | 60 | 66 | 72 | 78 |
| Return Config End Panel | None | O-Leg | 66 | 72 | 78 | 84 | NA |
| | None | L End Panel | 60 | 66 | 72 | 78 | 84 |

HOW TO SPECIFY

| | |
|--|--|
| <p>Select Model Number</p> <p>H 1 0 5 R 3 0 7 2</p> | <p>Select Worksurface Laminate and Edge Color</p> <p>See pages 266-267</p> <p>N N</p> |
|--|--|

10500 SERIES™ Worksurface Supports

GSA SIN 33721



Icon Legend on page 19

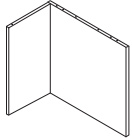

Not available in two-tone laminate

| DESCRIPTION | MODEL | SHIP WEIGHT | CUBE | LIST PRICE BY LAMINATE GRADE | |
|---------------------------|--------------------|-------------|------|------------------------------|--------------|
| | | | | L1 | L2 |
| L-shaped End Panel | | | | | |
| 15¾"W x 29⅞"D x 28½"H | H10530LEP | 49 | 4.1 | \$306 | \$318 |
| 15¾"W x 23⅞"D x 28½"H | H10524LEP | 43 | 3.7 | \$287 | \$299 |
| 15¾"W x 29⅞"D x 41"H | H1053041LEP | 68 | 4.2 | \$386 | \$406 |
| 15¾"W x 23⅞"D x 41"H | H1052441LEP | 60 | 3.4 | \$349 | \$369 |

NOTES: Non-handed. 29⅞"D for use with 48"-78"W x 30"D worksurfaces; 23⅞"D for use with 30"-78"W x 24"D worksurfaces. Not for use with 84"W unless additional floor supports are placed between the end panels. Design facilitates easy, open access to wall electrical outlets. Adjustable hex glides allow floor-standing units to be easily leveled without lifting to compensate for uneven floors. Glides have ¾" adjustable range. Two pieces; 1⅞" end panel and ¾" back panel. 10500 Series™ modular and mobile pedestals fit flush to the end panel. Simple assembly.

⚠ Not designed to be used freestanding.

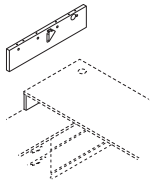

HNLEP307L shown

| Laminate End Panel — 7"H Support for Worksurfaces | | | | | |
|---|------------------|---|-----|--------------|-------------|
| 1⅞"W x 30"D x 7"H, Right | HNLEP307R | 7 | 0.7 | \$147 | \$10 |
| 1⅞"W x 30"D x 7"H, Left | HNLEP307L | 7 | 0.7 | \$147 | \$10 |
| 1⅞"W x 24"D x 7"H, Right | HNLEP247R | 6 | 0.7 | \$147 | \$10 |
| 1⅞"W x 24"D x 7"H, Left | HNLEP247L | 6 | 0.7 | \$147 | \$10 |

NOTES: Specifically for layered surface applications; used to support a 29½"H component worksurface over a 21½"H low credenza unit. 1⅞" thick. Handed design (left and right models). Includes cord routing notch. Bottom of end panel is edgedbanded for added strength and to seal out moisture. Attaches to underside of worksurface via cam fasteners and L-bracket; attaches to top of low credenza with double-sided tape. Can be specified in a woodgrain or solid laminate color only. For 7"H metal O-leg support see page 92.

SPECIFYING EXAMPLE: HNLEP307R.H

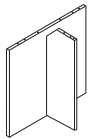

Not available in two-tone laminate

| | | | | | |
|---------------------------|------------------|----|-----|--------------|--------------|
| T-shaped End Panel | | | | | |
| 11⅝"W x 29⅞"D x 28½"H | H10530TEP | 45 | 3.7 | \$281 | \$293 |
| 11⅝"W x 23⅞"D x 28½"H | H10524TEP | 38 | 3.2 | \$263 | \$275 |

NOTES: Non-handed. For use with 30"D and 24"D 10500 Series worksurfaces. Two 1⅞" thick pieces; one end and one brace panel. Cord routing notch in brace panel. Simple assembly.

⚠ Not designed to be used freestanding.

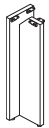

Not available in two-tone laminate

| | | | | | |
|------------------------|--------------------|----|-----|--------------|--------------|
| T-Support Brace | | | | | |
| 8"W x 8"D x 28½"H | H10524TSUPP | 14 | 0.8 | \$238 | \$253 |

NOTES: Intermediate support option for 29½"H workstations. Designed for 24"D and 30"D worksurfaces without a modesty or back panel, with an unsupported span greater than 48"W. Can be used to support the junction of two 24"D adjoining linear worksurfaces. Adjustable hex glides allow floor-standing units to be easily leveled without lifting to compensate for uneven floors; glides have ¾" adjustable range. Simple assembly.

NOTES:

- Adjustable hex leveling glides allow floor-standing furniture to be easily leveled without lifting the unit; glides have ¾" adjustable range.
- ⚠ Laminate L- and T-shaped end panels can be specified as one color only; not available in two-tone laminate combination or in a pattern laminate.

HOW TO SPECIFY

| | |
|----------------------------|------------------------|
| Select Model Number | Select Laminate |
| H 1 0 5 3 0 T E P . | See pages 266-267 |
| N | |



10500 SERIES™ Worksurface Supports

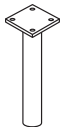

DESCRIPTION

Support Column for 10500 Series Rectangle and Bullet Worksurfaces

3" Diameter
For **Black**, specify HPC190X.P.
For **Silver**, specify HPC191X.X.

MODEL SHIP WEIGHT CUBE LIST PRICE

| | | | |
|----------------|-------------|-----|--------------|
| HPC190X | 12 Ⓞ | 1.0 | \$173 |
| HPC191X | 12 Ⓞ | 1.0 | \$173 |

NOTES: Can only be used as the outbound support in a peninsula or island extension worksurface application. Glides have 3/4" adjustable range.

! Support column must be specified for worksurfaces used as peninsulas or as an island extension.

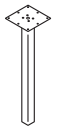

DESCRIPTION

Post Leg Base
28 1/2" H x 2" square

MODEL SHIP WEIGHT CUBE LIST PRICE BY PAINT GRADE
P1 P2 P3

| | | | | | |
|----------------|----|-----|--------------|--------------|--------------|
| HLSL28P | 15 | 1.0 | \$321 | \$325 | \$341 |
|----------------|----|-----|--------------|--------------|--------------|

NOTES: Can only be used as the outbound support in a peninsula or island extension worksurface application. Glides have 2" of adjustability. Ship 1/pack.

! Post leg can only be used to support peninsula, not as primary supports for a top.

SPECIFYING EXAMPLE: HLSL28P.T1

| 24" D Rectangle Worksurface Support Options | | | | |
|---|-----------------------------------|----------------------------|---|---|
| Product Application | Support Combination | | Support Model Numbers for 72" W, 66" W, or 60" W Worksurfaces | Support Model Numbers for 48" W or 42" W Worksurfaces |
| | Support 1 | Support 2 | | |
| Desk or Credenza | O-Leg | O-Leg | HLSL24280 (2) | HLSL24280 (2) |
| | O-Leg | L-Shaped End Panel | HLSL24280 / H10524LEP | HLSL24280 / H10524LEP |
| | L-Shaped End Panel | L-Shaped End Panel | H10524LEP (2) | H10524LEP (2) |
| | T-Shaped End Panel | O-Leg | H10524TEP / HLSL24280 | H10524TEP / HLSL24280 |
| | T-Shaped End Panel | L-Shaped End Panel | H10524TEP / H10524LEP | H10524TEP / H10524LEP |
| Peninsula for U- or L-Configuration; Not Freestanding | O-Leg | 3" Diameter Support Column | HLSL24280 / HPC190X-191X | NA |
| | O-Leg | 2" Square Post Leg | HLSL24280 / HLSL28P | NA |
| | L-Shaped End Panel | 3" Diameter Support Column | H10524LEP / HPC190X-191X | NA |
| | L-Shaped End Panel | 2" Square Post Leg | H10524LEP / HLSL28P | NA |
| | T-Shaped End Panel | 3" Diameter Support Column | H10524TEP / HPC190X-191X | NA |
| Desk, Credenza, or Freestanding Return or Bridge | Adjustable Height Base - Electric | | HHATB3S2LT/C | HHATB3S2LT/C (48" W min.) |
| Return (requires one support) | O-Leg | — | HLSL24280 | HLSL24280 |
| | L-Shaped End Panel | — | H10524LEP | H10524LEP |
| | T-Shaped End Panel | — | H10524TEP | H10524TEP |
| | 3" Diameter Support Column | — | HPC190X or HPC191X | HPC190X or HPC191X |
| | 2" Square Post Leg | — | HLSL28P | HLSL28P |
| Island Extension (requires one support) | O-Leg | — | HLSL24280 | HLSL24280 |
| | 3" Diameter Support Column | — | HPC190X or HPC191X | HPC190X or HPC191X |
| | 2" Square Post Leg | — | HLSL28P | HLSL28P |

| 72" W, 66" W, or 60" W x 30" D Bullet Worksurface Support Options | | | |
|---|----------------------------|----------------------------|--------------------------------|
| Product Application | Support Combination | | Support Model Numbers |
| | Support 1 | Support 2 | |
| Peninsula for U- or L-Configuration; Not Freestanding | O-Leg | 3" Diameter Support Column | HLSL30280 / HPC190X or HPC191X |
| | O-Leg | 2" Square Post Leg | HLSL30280 / HLSL28P |
| | L-Shaped End Panel | 3" Diameter Support Column | H10530LEP / HPC190X or HPC191X |
| | L-Shaped End Panel | 2" Square Post Leg | H10530LEP / HLSL28P |
| | T-Shaped End Panel | 3" Diameter Support Column | H10530TEP / HPC190X or HPC191X |
| | T-Shaped End Panel | 2" Square Post Leg | H10530TEP / HLSL28P |
| Island Extension | 3" Diameter Support Column | — | HPC190X or HPC191X |
| | 2" Square Post Leg | — | HLSL28P |

HOW TO SPECIFY

Select Model Number

H P C 1 9 0 X .

Select Paint Color

See page 183

T 1

10500 SERIES™ Worksurface Supports

OPEN MARKET



Icon Legend on page 19

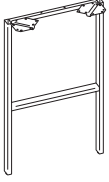

| DESCRIPTION | MODEL | SHIP WEIGHT | CUBE | LIST PRICE BY PAINT GRADE | | |
|---|---------------------|-------------|------|---------------------------|--------------|--------------|
| | | | | P1 | P2 | P3 |
| H-Leg Support for Worksurfaces 30"W x 28 ³ / ₈ "H 24"W x 28 ³ / ₈ "H | H105HLEG3028 | 13.6 | 5.1 | \$374 | \$378 | \$394 |
| | H105HLEG2428 | 12.5 | 3.7 | \$335 | \$339 | \$355 |
| Standing-Height H-Leg Support for Worksurfaces 30"W x 41"H 24"W x 41"H | H105HLEG3041 | 16.5 | 6.5 | \$503 | \$511 | \$523 |
| | H105HLEG2441 | 15.4 | 5.3 | \$450 | \$458 | \$470 |

NOTES:

- Legs ship fully assembled with mounting hardware, 1 per pack. Non-handed. H-leg glides have 2" adjustability. Will have 6" overhang when using 30"D H-legs with a 36"D worksurface.

! The H-leg attachment bracket interferes with placement of 10500 Series™ modular pedestals and 28³/₈"H mobile pedestals, preventing them from being positioned directly next to (flush with) the H-leg. Box/File mobile pedestal model H105106 and mobile printer/fax cart model H105679 can be positioned along side the H-leg.

! O- and H-legs may only be attached to worksurfaces, not storage units.

HOW TO SPECIFYSelect
Model Number









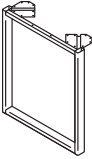

H 1 0 5 H L E G 2 4 4 1 .

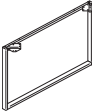
Select
Paint Color

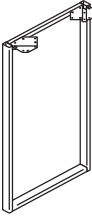
See page 183

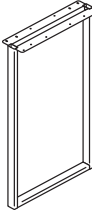
T 1

10500 SERIES™ Worksurface Supports

| | DESCRIPTION | MODEL | SHIP WEIGHT | CUBE | LIST PRICE BY PAINT GRADE | | |
|--|---|--|--------------|------------|------------------------------|------------------------------|------------------------------|
| | | | | | P1 | P2 | P3 |
|    | O-Leg 30"D x 28½"H 24"D x 28½"H | HLSL30280 ☉ HLSL24280 | 19.0 17.0 | 5.4 3.7 | \$395 \$357 | \$399 \$361 | \$415 \$377 |
| | <p>NOTES: Ship fully assembled with mounting hardware, 1/pack. Non-handed. O-leg glides have 2" adjustability. Shared O-legs create a cleaner aesthetic in all applications where two legs are used side-by-side. Will have 6" overhang when using 30"D O-legs with a 36"D worksurface.</p> <p>IMPORTANT: The O-leg attachment bracket interferes with placement of 10500 Series modular pedestals and 28¾"H mobile pedestals, preventing them from being positioned directly next to (flush with) the O-leg. Box/file mobile pedestal (model H105106) and mobile printer/fax cart model (H105679) can be positioned along side the O-leg.</p> <p>! O-legs may only be attached to worksurfaces, not storage units. SPECIFYING EXAMPLE: HLSL24280.T1</p> | | | | | | |
|    | Double-Depth O-Leg Support for Worksurfaces 60"D x 28½"H 48"D x 28½"H | HLSL60280 HLSL48280 | 19.0 18.0 | 8.7 7.0 | \$746 \$670 | \$754 \$678 | \$766 \$690 |
| | <p>NOTES: Ship fully assembled with mounting hardware, 1/package. Non-handed. 48"D and 60"D sizes span back-to-back 24"D and 30"D worksurfaces, respectively. O-leg glides have 2" adjustability. Shared O-legs create a cleaner aesthetic in all applications where two legs are used side-by-side. Will have 6" overhang when using 30"D O-legs with a 36"D worksurface.</p> <p>! O-legs may only be attached to worksurfaces, not storage units.</p> | | | | | | |
|    | Standing-Height O-Leg Support for Worksurfaces 30"D x 41"H 24"D x 41"H | HLSL30410 HLSL24410 | 17.0 16.0 | 6.5 5.3 | \$533 \$476 | \$539 \$482 | \$553 \$496 |
| | <p>NOTES: Ship fully assembled with mounting hardware, 1/package. Non-handed. O-leg glides have 2" adjustability. O-leg installation requires 6" of clearance from the worksurface end. Shared O-legs create a cleaner aesthetic in all applications where two legs are used side-by-side. Will have 6" overhang when using 30"D O-legs with a 36"D worksurface.</p> <p>Coordinate™ Power Modules will work with standing-height applications for 10500™ and Voi® desks.</p> <p>! O-legs may only be attached to worksurfaces, not storage units.</p> | | | | | | |
|    | Standing-Height O-Leg Shared Support for Worksurfaces 30"D x 41"H 24"D x 41"H | HLSL3041SL HLSL2441SL | 17.0 16.0 | 6.5 5.3 | \$593 \$537 | \$599 \$543 | \$613 \$557 |
| | <p>NOTES: Ship fully assembled with mounting hardware, 1/package. Non-handed. For use with two 24"D or 30"D worksurfaces positioned side-by-side along the depth dimension. O-leg glides have 2" adjustability. O-leg installation requires 6" of clearance from the worksurface end. Shared O-legs create a cleaner aesthetic in all applications where two legs are used side-by-side. Will have 6" overhang when using 30"D O-legs with a 36"D worksurface.</p> <p>Coordinate™ Power Modules will work with standing-height applications for 10500™ and Voi® desks. Please see Coordinate™ Accessories Stand-Alone Pricer pages for more information.</p> <p>! O-legs may only be attached to worksurfaces, not storage units.</p> | | | | | | |
|  OPEN MARKET | O-Leg Cord Clips Clips for 28½" Worksurface O-Legs — 8-Pack | HWMCLIPLG | 0.8 ☉ | 0.1 | \$110 | N/A | N/A |
| | <p>NOTES: Wire clips work with 7" Low Credenza O-leg and 29"H Support O-leg. Wire clips also work with the 50" and 65" Hutch O-legs. For additional information see the Workplace Tools section in the 2021 Shared Spaces Pricer.</p> <p>! Available in frosted plastic material only.</p> | | | | | | |

NOTES:

! For shared components such as modesty panels and Privacy Screens see pages 210-212.

HOW TO SPECIFY

| | |
|----------------------------|---------------------------|
| Select Model Number | Select Paint Color |
| See page 183 | See page 183 |
| H L S L 3 0 2 8 0 | T 1 |

10500 SERIES™ Worksurface Supports

GSA SIN 33721 EXCEPT AS NOTED



Icon Legend on page 19

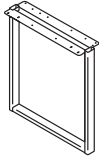

DESCRIPTION

O-Leg Shared Support for Worksurfaces

30"D x 28½"H
24"D x 28½"H

MODEL

HLSL3028SL ⓘ
HLSL2428SL

SHIP WEIGHT

19
17

CUBE

5.4
3.7

LIST PRICE BY PAINT GRADE

P1 P2 P3

\$491 \$495 \$511
\$443 \$447 \$463

NOTES: Ship fully assembled, 1/pack. Non-handed.

ⓘ Specify paint only.

SPECIFYING EXAMPLE: HLSL2028SL.T1

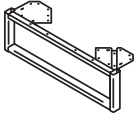

O-Leg Support for Low Credenzas

30"D x 7"H
24"D x 7"H

HLSL3070 ⓘ
HLSL2470

7
6

1.0
1.0

\$305 \$309 \$325
\$240 \$244 \$260

NOTES: Ship fully assembled, 1/pack. Non-handed. For 7"H laminate support see page 90.

ⓘ Specify paint only.

SPECIFYING EXAMPLE: HLSL2070.T1

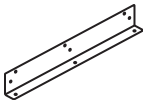

HVPWLBK24 shown

DESCRIPTION

Worksurface Wall Mount Bracket

For 30"
For 24"

MODEL

HVPWLBK30
HVPWLBK24

SHIP WEIGHT

2
2

CUBE

0.3
0.3

LIST PRICE

\$99
\$90

NOTES: Can be used in place of an end panel or O-leg to support a worksurface. Cannot be used as a support when placing a stack-on storage unit on worksurface over bracket; must have two full-sized floor supports when using stack-on storage. Finish option not required.

SPECIFYING EXAMPLE: HVPWLBK30

OPEN MARKET



DESCRIPTION

Worksurface to Tower Bracket Kit

18½" long bracket for attaching 24"D worksurface directly to storage tower, wardrobe/bookcase, wardrobe/storage cabinet, storage cabinet/lateral file, storage cabinet, or lateral file.

MODEL

HSTB2W1

SHIP WEIGHT

4

CUBE

0.6

LIST PRICE BY PAINT GRADE

P1 P2 P3

\$88 \$101 \$103

NOTES: Can be used in place of end panel or O-leg to support worksurfaces.

ⓘ Bracket not designed for use as a support if placing Stack-on Storage on worksurface over/above bracket. Two full-sized supports required when using Stack-on Storage.

NOTES:

- O-leg glides have 2" adjustability.
- For shared components such as modesty panels and Privacy Screens see pages 210-212.
- O-leg ships fully assembled with mounting hardware.
- For standing-height O-leg sizes, see page 283.
- Shared O-legs create a cleaner aesthetic in all applications where two legs are used side-by-side.
- Will have 6" overhang when using 30"D O-legs with a 36"D worksurface.

ⓘ O-legs may only be attached to worksurfaces, not storage units.

ⓘ O-leg installation requires 6" of clearance from the worksurface end.

HOW TO SPECIFY

| | |
|----------------------------|---------------------------|
| Select Model Number | Select Paint Color |
| | See page 183 |
| HVPWLBK30 | T1 |

10500 SERIES™

Components — Supports

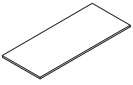
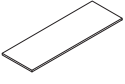
| | DESCRIPTION | MODEL | SHIP WEIGHT | CUBE | LIST PRICE BY LAMINATE GRADE | |
|---|------------------------------|------------------|-------------|------|------------------------------|--------------|
| | | | | | L1 | L2 |
|  | Rectangle Worksurface | | | | | |
| | 72"W x 30"D | H105R3072 | 83 | 6.1 | \$427 | \$447 |
| | 66"W x 30"D | H105R3066 | 76 | 6.1 | \$397 | \$417 |
| | 60"W x 30"D | H105R3060 | 69 | 5.2 | \$370 | \$390 |
| | 48"W x 30"D | H105R3048 | 55 | 4.1 | \$304 | \$319 |
|  | 72"W x 24"D | H105R2472 | 66 | 4.9 | \$363 | \$383 |
| | 66"W x 24"D | H105R2466 | 61 | 4.9 | \$351 | \$371 |
| | 60"W x 24"D | H105R2460 | 55 | 4.2 | \$330 | \$350 |
| | 48"W x 24"D | H105R2448 | 44 | 3.4 | \$280 | \$295 |
| | 42"W x 24"D | H105R2442 | 39 | 3.0 | \$254 | \$269 |

NOTES: Underside of rectangle worksurfaces includes pilot mounting holes for end panels, support columns, post and O-legs, and height adjustable base. Applications for 24"D worksurfaces include desks, credenzas, returns, and bridges. The 42"W x 24"D size is not compatible with Height Adjustable Base model HHATB3S2LT/C; it can however, be used in combination with the 72"W x 30"D worksurface on 3-Leg Height Adjustable Base model HHATB3S3LT. For Above Privacy Screen sizes, see page 212.

NOTES:

- Height Adjustable Base is a 3-stage column design.
 - Frame rises from 21⁵/₈" to 47³/₄" for a sit-to-stand desk option.
 - Height Adjustable Bases shipped complete with a pre-assembled motor.
 - Base telescopes to accommodate any worksurface between 48"W and 72"W.
 - Height Adjustable Base accommodates rectangular worksurfaces between 24"D x 48"W and 30"D x 72"W. Systems, Voi®, 10500, and Preside® all have worksurfaces within this range.
 - Comes standard with one-touch, four memory controller with digital display; no specification needed, available in black finish only.
 - Standard height adjustable control ships with base.
 - Dynamic load capacity when worksurface is moving is 250 lbs.
- ⓘ If using worksurfaces with Coordinate™ Height Adjustable Bases, an External Stiffener must be specified separately.
- ⓘ Worksurfaces used with Coordinate™ Height Adjustable Bases should have 1" perimeter gap on each side to provide clearance between other furniture. Failure to do so risks injury or product damage (not covered by warranty).

HOW TO SPECIFY

| | |
|----------------------------|------------------------|
| Select Model Number | Select Laminate |
| | See pages 266-267 |
| H 1 0 5 R 3 0 7 2 | N N |

10500 SERIES™

Height Adjustable Bases

GSA SIN AS NOTED



Icon Legend on page 19

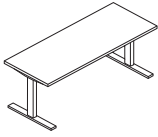

Base shown with worksurface attached.

OPEN MARKET

DESCRIPTION

Coordinate™ Height Adjustable Base – 2 Stage
2-Leg Rectangle T Foot

MODEL

HHATB2S2LT

SHIP WEIGHT

66.0

CUBE

2.4

LIST PRICE

\$950

NOTES:

- Dual motor two-leg design. Legs raise from 25 $\frac{5}{8}$ " to 45 $\frac{1}{4}$ ".
- Base accommodates any rectangular worksurface between 23"D x 40"W and 30"D x 72"W.
- Weight capacity of 250 lbs. (including the weight of the worksurface) distributed evenly.
- Control Box: 120V, 4A, 60Hz, 400W.
- 9' grounded power cord.
- 1 $\frac{1}{2}$ " /second travel speed.
- <50 dB noise rating.
- **HON 10-Year Warranty.**

ⓘ Requires the use of an external stiffener (purchased separately) for worksurfaces over 58"W or wider when not used with a Coordinate™ worksurface.

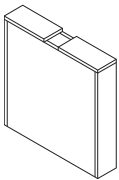

Not available in two-tone laminate.

SIN 33721

Shroud for Height Adjustable Base

5 $\frac{1}{8}$ "W x 26"D x 24 $\frac{1}{4}$ "H for Base with 30"D Top

HLAMSHB30

39.0

3.7

\$899

NOTES: Decorative laminate enclosure covers the Coordinate™ metal leg and foot. For use with standard 10500 Series™, Concinnity™, and Voi® rectangle worksurfaces, 48-72"W x 30"D, supported by Height Adjustable Base model HHATB2S2LT. For height adjustable desks requiring a modesty panel, options include: 14"H laminate (HLSLXX14L) or mixed material (HLSLXX14MM) floating modesty panels, laminate full length (HNLMPXX28) or short (HNLMPXX10) modesty/back panel plus external support channel (HLSLZ5SCXX). External support channel attachment screws and modesty/back panel cover caps are included in the shroud hardware pack. External support channel size recommendation, specific to worksurface attached to Height Adjustable Base with optional laminate full-length or short modesty back/panel (HNLMPXX28/10) see below. Ships one per carton. To conceal both metal legs on the Height Adjustable Base order two. When using a modesty panel set height adjustable table at 29"H to ensure table stops before hitting shroud. Specify: Model.Laminate; see pages 266-267.

SPECIFYING EXAMPLE: HLAMSHB30.N

- ⓘ Lowest base adjustment position when the shroud is installed is 29 $\frac{1}{2}$ "H; memory controller must be set at that height to avoid interference.
- ⓘ The Height Adjustable Base must be reset at the time of installation, after every loss of power, if the unit is not functioning properly, or if the legs are uneven. To reset the base requires removing the laminate shroud(s), as well as the full-length modesty panel if one is being used, then adjusting the base to its lowest position. Disassembly of the shroud is quick and easy.
- ⓘ \$25 upcharge for L2 laminates.

| Worksurface Width | Modesty/Back Panel Width | External Support Channel |
|-------------------|--------------------------|--------------------------|
| 72"W | 72"W | HLSLZ5SC78 |
| 66"W | 66"W | HLSLZ5SC72 |
| 60"W | 60"W | HLSLZ5SC66 |
| 54"W | 54"W | HLSLZ5SC60 |
| 48"W | 48"W | HLSLZ5SC54 |



SIN 33721

Under Worksurface Power Module – 4 Outlets, 10' Cord

HPWRMOD2

1.5

0.2

\$441

- Includes 10' cord with three-prong plug.
- Fits in cable management troughs. See page 242.
- 4 outlets on side create easy access.

NOTES: Power Modules will also work with standing-height applications for 10500 Series™ and Voi® desks. For additional information see the Workplace Tools section in the 2021 Shared Spaces Pricer.

- ⓘ Available in black finish only, no specification needed.

NOTES:

- ⓘ Coordinate™ Height Adjustable Bases not compatible with 36"D rectangular worksurfaces.

HOW TO SPECIFY

| | | | |
|--|--|---|---|
| Select Model Number HHATB2S2LT | Select Paint Color See page 116 P71 | Select Foot X Standard Foot S Slide Glide X | Select Keypad UD Basic Up/Down MEM Memory Preset PDL Paddle RTG Rotating (+ \$50) FPD Foot Pedal (+ \$175) MEM |
|--|--|---|---|



10500 SERIES™ Shared Components

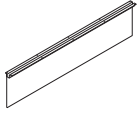

| DESCRIPTION | MODEL | SHIP WEIGHT | CUBE | LIST PRICE BY LAMINATE GRADE | |
|--|------------------|-------------|------|------------------------------|--------------|
| | | | | L1 | L2 |
| Laminate Floating Modesty Panel | | | | | |
| 60"W x 14"H | HLSL6014L | 20 | 1.1 | \$277 | \$289 |
| 54"W x 14"H | HLSL5414L | 18 | 1.1 | \$258 | \$270 |
| 48"W x 14"H | HLSL4814L | 16 | 1.1 | \$236 | \$248 |
| 42"W x 14"H | HLSL4214L | 14 | 0.8 | \$214 | \$224 |
| 36"W x 14"H | HLSL3614L | 12 | 0.8 | \$202 | \$212 |
| 30"W x 14"H | HLSL3014L | 10 | 0.8 | \$191 | \$201 |

NOTES: The attachment bracket and modesty panel are packaged separately.

Specify: Model.Laminate.Paint

SPECIFYING EXAMPLE: HLSL3014L.N.P (Black is the only paint option for this model)

ⓘ When specifying the 54"W or 60"W Laminate Floating Modesty Panel, it is not necessary to specify an external channel.

ⓘ 30"W and 36"W screens attach with L-brackets, not the external channel.

NOTES:

- Laminate or mixed material floating modesty panels options are available for attachment under 10500 Series worksurfaces. The modesty panel and attachment bracket are packaged separately.
- If using a 54"W or 60"W floating modesty panel, it is not necessary to specify an external support channel under the worksurface.
- When using a floating modesty panel under the worksurface, the depth clearance for center drawers and keyboard platforms decreases by 8".

| FLOATING MODESTY PANELS - MODEL SELECTION GUIDE | | | | | | |
|---|-----------------------------|-----------------------------|----------|----------|----------|----------|
| Support Combination | | Rectangle Worksurface Width | | | | |
| Support 1 | Support 2 | 72 in | 66 in | 60 in | 48 in | 42 in |
| O-Leg | O-Leg | HLSL6014 | HLSL5414 | HLSL4814 | HLSL3614 | HLSL3014 |
| O-Leg | L-Shaped End Panel | HLSL4814 | HLSL4214 | HLSL3614 | NA | NA |
| O-Leg | 4½" Diameter Support Column | HLSL4814 | HLSL4814 | HLSL4814 | HLSL3614 | HLSL3014 |
| O-Leg | 2" Square Post Leg | HLSL4814 | HLSL4814 | HLSL4814 | HLSL3614 | HLSL3014 |
| L-Shaped End Panel | L-Shaped End Panel | HLSL3614 | HLSL3014 | NA | NA | NA |
| L-Shaped End Panel | 4½" Diameter Support Column | HLSL3614 | HLSL3614 | HLSL3614 | NA | NA |
| L-Shaped End Panel | 2" Square Post Leg | HLSL3614 | HLSL3614 | HLSL3614 | NA | NA |
| T-Shaped End Panel | O-Leg | HLSL5414 | HLSL4814 | HLSL4214 | HLSL3014 | NA |
| T-Shaped End Panel | L-Shaped End Panel | HLSL3614 | HLSL3014 | NA | NA | NA |
| T-Shaped End Panel | 4½" Diameter Support Column | HLSL3614 | HLSL3014 | NA | NA | NA |
| T-Shaped End Panel | 2" Square Post Leg | HLSL3614 | HLSL3014 | NA | NA | NA |

| Support Combination | | Bullet Worksurface Width | | |
|---------------------|-----------------------------|--------------------------|----------|----------|
| Support 1 | Support 2 | 72 in | 66 in | 60 in |
| O-Leg | 4½" Diameter Support Column | HLSL4814 | HLSL4814 | HLSL4814 |
| O-Leg | 2" Square Post Leg | HLSL4814 | HLSL4814 | HLSL4814 |
| L-Shaped End Panel | 4½" Diameter Support Column | HLSL3614 | HLSL3614 | HLSL3614 |
| L-Shaped End Panel | 2" Square Post Leg | HLSL3614 | HLSL3614 | HLSL3614 |
| T-Shaped End Panel | 4½" Diameter Support Column | HLSL3614 | HLSL3614 | HLSL3614 |
| T-Shaped End Panel | 2" Square Post Leg | HLSL3614 | HLSL3614 | HLSL3614 |

HOW TO SPECIFY

Select
Model Number

H L S L 3 0 1 4 L .

Select
Laminate

See pages 266-267

N

10500 SERIES™

Shared Components

GSA SIN 33721

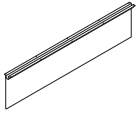

Icon Legend on page 19

**DESCRIPTION****Mixed Material Floating Modesty Panel**

60"W x 14"H
54"W x 14"H
48"W x 14"H
42"W x 14"H
36"W x 14"H
30"W x 14"H

MODEL

HLSL6014MM ☉
HLSL5414MM ☉
HLSL4814MM ☉
HLSL4214MM ☉
HLSL3614MM
HLSL3014MM

SHIP WEIGHT

13
13
11
9
8
8

CUBE

3.3
3.3
2.6
2.3
2.0
2.0

LIST PRICE

\$1243
\$1089
\$1002
\$906
\$810
\$755

NOTES: The attachment bracket and modesty panel are packaged separately. Laminate or mixed material floating modesty panels options are available for attachment under 10500 Series worksurfaces. The modesty panel and attachment bracket are packaged separately. If using a 54"W or 60"W floating modesty panel, it is not necessary to specify an external support channel under the worksurface. When using a floating modesty panel under the worksurface, the depth clearance for center drawers and keyboard platforms decreases by 8". See charts on previous page.

Specify: Model.Mixed Material.Paint

SPECIFYING EXAMPLE: HLSL3014MM.FT01.P (Frosted Translucent mixed material and Black paint are the only options for this model)

⚠ When specifying the 54"W or 60"W Mixed Material Floating Modesty Panel, it is not necessary to specify an external channel.

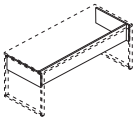

Not available in
two-tone laminate

Modesty Panels for Desks with O-Legs

68³/₈"W x 3¹/₄"D x 10"H — For 72" x 30" Desks
56³/₈"W x 3¹/₄"D x 10"H — For 60" x 30" Desks

HLAMMP7230
HLAMMP6030

26
23

2.1
1.8

\$307
\$280

NOTES: For use with 60"W or 72"W worksurfaces supported by O-legs. Comprised of three panels: one approach side and one for each end. Length below bottom of worksurface is 10". Steel external support channel (ordered separately) is recommended for unsupported spans greater than 54"W (i.e.: a distance in which there is not a vertical support between the underside of the worksurface and floor). Grain direction is vertical on approach and side panels for 56³/₈"W (all laminate colors) and 68³/₈"W (L1 laminate except Florence Walnut and Kingswood Walnut). Vertical on 27⁵/₈" end panels (all laminate colors). Horizontal on all panels for L2 laminates as well as Florence Walnut and Kingswood Walnut.

Specify: Model.Laminate

SPECIFYING EXAMPLE: HLAMMP7230.N

⚠ \$15 upcharge for L2 laminates. See pages 266-267 for laminate options.

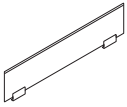
**Above Privacy Screen**

60"W x 13"H
54"W x 13"H
48"W x 13"H
42"W x 13"H
36"W x 13"H
30"W x 13"H

HLSL1260
HLSL1254
HLSL1248
HLSL1242
HLSL1236
HLSL1230

24
22
20
18
15
13

2.9
2.9
2.3
2.3
1.8
1.5

\$508
\$473
\$443
\$387
\$345
\$313

NOTES: Ships complete with attachment bracket. Bracket is Platinum only, no need to specify. Attaches to top of rectangle worksurfaces; requires a minimum overhang of 1¹/₂".

⚠ Available in Frosted Glass ONLY HLSL1230.G.

⚠ Above only Privacy Screen clamps onto worksurface and cannot be installed where support storage will be attached.

HOW TO SPECIFY

Select
Model Number

H L S L 3 0 1 4 M M .

Select
Mixed Material

FT01 Frosted Translucent

F T 0 1

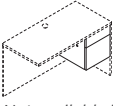
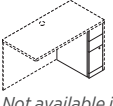
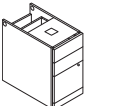
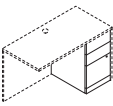
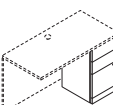

10500 SERIES™ Laminate Modular Components

| | DESCRIPTION | MODEL | SHIP WEIGHT | CUBE | LIST PRICE BY LAMINATE GRADE | |
|---|--|----------------|-------------|------|------------------------------|--------------|
| | | | | | L1 | L2 |
|  Not available in two-tone laminate | Box/File Pedestal (with core removable lock) 15 $\frac{5}{8}$ "W x 22 $\frac{3}{4}$ "D x 17 $\frac{3}{4}$ "H — for use under 24"D, 30"D and 36"D desk, credenza and return shells NOTES: Attaches to underside of worksurface top. Lock can be positioned on either the right or left side. File drawer includes integrated hangrails for letter- or legal-sized folders. Not for use under 20"D shells. ⓘ Not designed to be used freestanding. Unfinished top and back. | H10501 | 57 | 5.5 | \$555 | \$575 |
|  Not available in two-tone laminate | Narrow Box/Box/File Pedestal (with core removable lock) — floor-standing 9 $\frac{1}{2}$ "W x 22 $\frac{3}{4}$ "D x 28"H — for use under 24"D, 30"D and 36"D desk, credenza and return shells NOTES: Space-saving design supports smaller footprints. Middle box drawer and file drawer lock; top box drawer does not lock. File drawer includes integrated hangrails for side-to-side letter or legal filing. Not for use under 20"D shells. ⓘ Not designed to be used freestanding. Unfinished top and back. | H105093 | 61 | 5.6 | \$717 | \$742 |
|  Not available in two-tone laminate | Box/Box/File Pedestal — floor-standing 15 $\frac{5}{8}$ "W x 28 $\frac{3}{4}$ "D x 28"H — for use under 10500 Series 30"D worksurfaces supported by 29 $\frac{7}{8}$ "D L-shaped end panel model H10530LEP NOTES: Top box drawer does not lock. File drawer includes integrated hangrails for letter- or legal-sized folders. Not for use under shells, per "Inside Dimensions" listings. ⓘ Not designed to be used freestanding. Unfinished top and back. | H105062 | 105 | 10.5 | \$788 | \$818 |
|  Not available in two-tone laminate | Box/Box/File Pedestal (with core removable lock) — floor-standing 15 $\frac{5}{8}$ "W x 22 $\frac{3}{4}$ "D x 28"H — for use under 24"D, 30"D and 36"D desk, credenza and return shells or worksurface supported by 23 $\frac{7}{8}$ "D L-shaped end panel(s) NOTES: Top box drawer does not lock. File drawer includes integrated hangrails for letter- or legal-sized folders. Not for use under 20"D shells. ⓘ Not designed to be used freestanding. Unfinished top and back. | H10502 | 90 | 8.4 | \$728 | \$753 |
|  Not available in two-tone laminate | Box/Box/File Pedestal (with core removable lock) — floor-standing 15 $\frac{5}{8}$ "W x 18 $\frac{3}{4}$ "D x 28"H — for use under 20"D, 24"D, 30"D and 36"D desk, credenza and return shells NOTES: Top box drawer does not lock. File drawer includes integrated hangrails for letter- or legal-sized hanging folders. ⓘ Not designed to be used freestanding. Unfinished top and back. | H105012 | 73 | 7.3 | \$686 | \$706 |

NOTES:

- Pedestals can be reconfigured quickly and easily when user preferences or space needs change.
- Locking units equipped with interchangeable core removable locks.
- Pedestal models ship assembled unless designated ☞.
- Mobile pedestals shown on page 311, work well in a variety of configurations.
- Narrow Pedestal features a compact design that is ideal for use in U- and L-shaped layouts for smaller spaces such as a 5' x 8' U-shaped workstation or a 5' x 5' L-shaped workstation.
- 10500 Series™ modular pedestals are for use with desk, credenza and return shells (see pages 274-278), as well as L-shaped end panels (page 280).
- ⓘ Keyed alike cores must be ordered separately — see model HF23B on page 773 — makes re-keying quick and easy.
- ⓘ Access strip (filler) required when box/box file, file/file, and or narrow box/box/file pedestals are configured side-by-side to allow access for opening the drawers.
- ⓘ Modular pedestals can be specified as one color only; not available in two-tone laminate combination or in a pattern laminate.

HOW TO SPECIFY



| | |
|---|--|
| Select Model Number H 1 0 5 0 9 3 | Select Laminate Chassis Color See pages 266-267 N |
|---|--|

10500 SERIES™ Laminate Modular Components

GSA SIN 33721

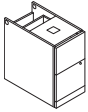
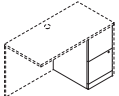
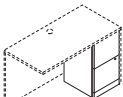

Icon Legend on page 19

| | DESCRIPTION | MODEL | SHIP WEIGHT | CUBE | LIST PRICE BY LAMINATE GRADE | |
|--|---|----------------|-------------|------|------------------------------|--------------|
| | | | | | L1 | L2 |
|  Not available in two-tone laminate | File/File Pedestal — floor-standing 15 ⁵ / ₈ "W x 28 ³ / ₄ "D x 28"H — for use under 10500 Series 30"D worksurfaces supported by 29 ⁷ / ₈ "D L-shaped end panel model H10530LEP NOTES: File drawer includes integrated hangrails for letter- or legal-sized folders. Not for use under shells, per "Inside Dimensions" listings. ⓘ Not designed to be used freestanding. Unfinished top and back. | H105064 | 104 | 10.5 | \$788 | \$818 |
|  Not available in two-tone laminate | File/File Pedestal (with core removable lock) — floor-standing 15 ⁵ / ₈ "W x 22 ³ / ₄ "D x 28"H — for use under 24"D, 30"D and 36"D desk, credenza and return shells or worksurface supported by 23 ⁷ / ₈ "D L-shaped end panel(s) NOTES: File drawers include integrated hangrails for letter- or legal-sized folders. Not for use under 20"D shells. ⓘ Not designed to be used freestanding. Unfinished top and back. | H10504 | 85 | 8.2 | \$728 | \$753 |
|  Not available in two-tone laminate | File/File Pedestal (with core removable lock) — floor-standing 15 ⁵ / ₈ "W x 18 ³ / ₄ "D x 28"H — for use under 20"D, 24"D, 30"D and 36"D desk, credenza and return shells NOTES: File drawers include integrated hangrails for letter- or legal-sized folders. ⓘ Not designed to be used freestanding. Unfinished top and back. | H105014 | 72 | 7.3 | \$686 | \$706 |
|  Not available in two-tone laminate | Access Strip (Filler) 1 ¹ / ₈ "W x 20 ¹ / ₂ "D x 28"H NOTES: For use under 24"D, 30"D and 36"D desk, credenza or return shells when B/B/F, F/F, and or narrow B/B/F pedestals are configured side-by-side. Not required when pedestals are used in conjunction with lateral file pedestals, multi file pedestals or cabinet pedestal. Not sized for use with 20"D modular shells. NOTE: See pages 274-278 for desk, credenza and return shells. | H10524 | 21 | 0.9 | \$187 | \$197 |

NOTES:

- Pedestals can be reconfigured quickly and easily when user preferences or space needs change.
- Locking units equipped with interchangeable core removable locks.
- Pedestal models ship assembled unless designated ⓘ.
- Mobile pedestals shown on page 311, work well in a variety of configurations.
- Narrow Pedestal features a compact design that is ideal for use in U- and L-shaped layouts for smaller spaces such as a 5' x 8' U-shaped workstation or a 5' x 5' L-shaped workstation.
- 10500 Series™ modular pedestals are for use with desk, credenza and return shells (see pages 274-278), as well as L-shaped end panels (page 280).
- ⓘ Keyed alike cores must be ordered separately — see model HF23B on page 773 — makes re-keying quick and easy.
- ⓘ Access strip (filler) required when box/box file, file/file, and or narrow box/box/file pedestals are configured side-by-side to allow access for opening the drawers.
- ⓘ Modular pedestals can be specified as one color only; not available in two-tone laminate combination or in a pattern laminate.

HOW TO SPECIFY

| | |
|--|---|
| <p>Select Model Number</p> <p>H 1 0 5 0 4 . N</p> | <p>Select Laminate Chassis Color</p> <p>See pages 266-267</p> <p>N</p> |
|--|---|

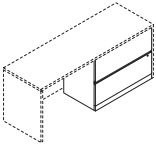
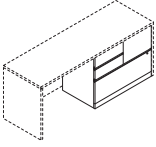
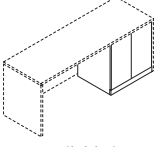
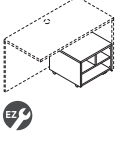
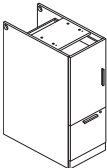

10500 SERIES™ Laminate Modular Components

| | DESCRIPTION | MODEL | SHIP WEIGHT | CUBE | LIST PRICE BY LAMINATE GRADE | |
|---|--|----------------------------------|-------------|--------------|--------------------------------|--------------------------------|
| | | | | | L1 | L2 |
|  Not available in two-tone laminate | Lateral File Pedestal (with core removable lock) — Floor-standing 36"W x 20"D x 28"H — For use under 24"D, 30"D and 36"D desk, credenza and return shells NOTES: Drawers include integrated hangrails for letter- or legal-sized folders. Mechanical interlock inhibits extension of more than one drawer at a time. Not for use under 20"D shells. ! Not designed to be used freestanding. Unfinished top and back. | H10503 | 127 | 15.6 | \$1105 | \$1145 |
|  Not available in two-tone laminate | Multi File Pedestal (with core removable lock) — Floor-standing 36"W x 20"D x 28"H — For use under 24"D, 30"D and 36"D desk, credenza and return shells NOTES: Versatile four drawer unit features a lateral file, vertical file, and two box drawers. Box drawers do not lock. File drawers include integrated hangrails for letter- or legal-sized folders. Mechanical interlock in lateral drawer inhibits extension of more than one drawer at a time. Not for use under 20"D shells. ! Not designed to be used freestanding. Unfinished top and back. | H10505 | 155 | 15.6 | \$1324 | \$1364 |
|  Not available in two-tone laminate | Cabinet Pedestal — Floor-standing 26"W x 21¼"D x 28"H — For use under 24"D, 30"D and 36"D desk, credenza and return shells NOTES: One adjustable shelf at 2½" increments. Doors are non-locking. Not for use under 20"D shells. ! Not designed to be used freestanding. Unfinished top and back. | H10508 | 78 | 12.2 | \$824 | \$864 |
|  EZ | Mobile Printer/Fax Cart 20"W x 19¼"D x 14½"H — For use under 24"D, 30"D and 36"D desk, credenza and return shells NOTES: Holds laser printers, inkjet printers or fax machines. Ideal for limited space. Low profile cart stores conveniently and easily under desks and workstations. Interior compartment shelving is Black. Four casters. Specify laminate top and chassis color. Not for use under 20"D shells. SPECIFYING EXAMPLE: H105679.NN | H105679 | 52 | 2.9 | \$451 | \$471 |
|  Not available in two-tone laminate | Box/Shelf/File Pedestal 15½"W x 28¾"D x 41"H — For 30"D worksurfaces 15½"W x 22¾"D x 41"H — For 24"D or 30"D worksurfaces NOTES: For 42"H standing-height desks. Designed to be used under a component worksurface supported on the pedestal end(s) by 41"H L-shaped end panel(s). For single pedestal workstations, the non-pedestal end can be supported by a 41"H L-shaped end panel, H-leg, or O-leg. Adjustable hex glides allow floor-standing units to be easily leveled without lifting to compensate for uneven floors; glides have ¾" adjustable range. Cabinet includes one box (supply) drawer and two shelves (one fixed, one adjustable); shelf adjusts in ¼" increments with a range of 5". Not to be used freestanding, top and back are not enclosed. Pedestal depth is less than the depth of the respective component top to accommodate L-shaped end panel. File drawer includes integrated hangrails. Standard with linear handles in black finish. | H105077 H105076 | 104 89 | 14.7 11.9 | \$1521 \$1468 | \$1576 \$1518 |

NOTES:

- Pedestals can be reconfigured quickly and easily when user preferences or space needs change.
- File drawers accept hanging folders in letter or legal size.
- Mobile pedestals shown on page 311, work well in a variety of configurations.
- Locking units equipped with interchangeable core removable locks.
- Pedestal models ship assembled unless designated .
- See pages 274-278 for desk, credenza and return shells.

 Keyed alike cores must be ordered separately — see model HF23B on page 773 — makes re-keying quick and easy.

 Access strip (filler) required when box/box file, file/file, and or narrow box/box/file pedestals are configured side-by-side to allow access for opening the drawers.

HOW TO SPECIFY

| | |
|---|---|
| Select Model Number H 1 0 5 0 3 . N | Select Laminate Chassis Color See pages 266-267 |
|---|---|

10500 SERIES™

Laminate Wood Desks — Full Pedestals

GSA SIN 33721



Icon Legend on page 19

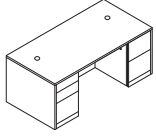

| DESCRIPTION | FULL WIDTH OVERHANG | MODEL | SHIP WEIGHT | CUBE | LIST PRICE BY LAMINATE GRADE | |
|---|---------------------|----------------|-------------|------|------------------------------|---------------|
| | | | | | L1 | L2 |
| Double Pedestal Desk | | | | | | |
| 72"W x 36"D x 29½"H, Bow Top, 3/2 | 10½" | H105899 | 315 | 50.9 | \$1980 | \$2060 |
| 72"W x 36"D x 29½"H, Rectangle Top, 3/2 | 10½" | H105890 | 340 | 50.9 | \$1805 | \$1880 |
| 66"W x 30"D x 29½"H, Rectangle Top, 3/2 | 4½" | H105891 | 290 | 39.4 | \$1682 | \$1747 |
| 60"W x 30"D x 29½"H, Rectangle Top, 3/2 | 4½" | H105892 | 278 | 35.9 | \$1581 | \$1641 |

NOTES: All drawers lock. Two cord grommets in top for routing and hiding wires and cables. Bow top models measure 36"D at crest and 30"D along the end panels. See page 319 for optional center drawers.

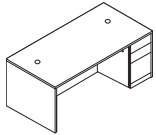

| | | | | | | |
|---|------|-------------------|-----|------|---------------|---------------|
| Single Pedestal Desk | | | | | | |
| 72"W x 36"D x 29½"H, Bow Top, Right | 10½" | H105893R | 292 | 50.9 | \$1622 | \$1692 |
| 72"W x 36"D x 29½"H, Rectangle Top, Right | 10½" | H105895R Ⓢ | 278 | 50.9 | \$1443 | \$1513 |
| 66"W x 30"D x 29½"H, Rectangle Top, Right | 4½" | H105897R | 226 | 39.4 | \$1303 | \$1358 |
| 72"W x 36"D x 29½"H, Bow Top, Left | 10½" | H105894L | 292 | 50.9 | \$1622 | \$1692 |
| 72"W x 36"D x 29½"H, Rectangle Top, Left | 10½" | H105896L Ⓢ | 278 | 50.9 | \$1443 | \$1513 |
| 66"W x 30"D x 29½"H, Rectangle Top, Left | 4½" | H105898L | 226 | 39.4 | \$1303 | \$1358 |

NOTES: Box/box/file drawers. Drawers lock. Two cord grommets in top for routing and hiding wires and cables. Bow top models measure 36"D at crest and 30"D along the end panels. See page 319 for optional center drawers.

NOTES:

- Factory-configured desks, credenzas and returns ship fully assembled for ease and speed of installation.
- Full-to-floor pedestals maximize storage space.
- Smooth, flat edges provide a clean look.
- Tops are easy-care, scratch-, spill- and stain-resistant laminate over 1/8" solid core high-performance particleboard.
- 3" round cord management grommets, for routing and hiding wires and cables, are located in the tops of desks, returns, bridges, and corner units. Grommet cutout accepts optional Power Hub (model HGRMTAC) or Power/USB Hub (model HGRMTUSB2) — see page 324.
- For work-in-process paper management tools, see pages 319-320.
- Drawers operate on full extension, ball-bearing suspensions to ensure smooth, quiet, long-lasting operation.
- File drawer design includes integrated hangrails for side-to-side letter or legal filing; and front-to-back for letter filing.
- For field installable decorative handle options, see page 322.
- All drawers are five-sided construction for added strength and easy alignment or replacement of drawer fronts.
- Center drawers conveniently store writing instruments, paper and other miscellaneous items. Includes pencil tray. See page 325.

HOW TO SPECIFY

Select Model Number

H 1 0 5 8 9 9 .

Select Laminate Top and Chassis Color

See pages 266-267

N N

10500 SERIES™

Laminate Wood Desks — Full Pedestals

| | DESCRIPTION | FULL WIDTH OVERHANG | MODEL | SHIP WEIGHT | CUBE | LIST PRICE BY LAMINATE GRADE | |
|--|---|---------------------|-----------------|-------------|------|------------------------------|---------------|
| | | | | | | L1 | L2 |
| | Return, file/file | | | | | | |
| | 48"W x 24"D x 29½"H, Right | | H105905R | 167 | 24.2 | \$1020 | \$1060 |
| | 42"W x 24"D x 29½"H, Right | | H105907R | 147 | 21.4 | \$998 | \$1038 |
| | 48"W x 24"D x 29½"H, Left | | H105906L | 167 | 24.2 | \$1020 | \$1060 |
| | 42"W x 24"D x 29½"H, Left | | H105908L | 147 | 21.4 | \$998 | \$1038 |
| NOTES: Return is for use with single pedestal desks, desk shells, peninsulas or corner units. One worksurface grommet and one cord pass-through grommet in top center of modesty panel to reach wall electrical outlets. Drawers lock. Not to be used freestanding. Will not attach to Corner Units manufactured prior to 5/24/99. See pages 302-303 for optional Stack-on Storage. | | | | | | | |
| | Credenza with Doors | | | | | | |
| | 72"W x 24"D x 29½"H | 3½" | H105909 | 323 | 34.8 | \$1868 | \$1933 |
| NOTES: All drawers lock. Doors are non-locking. Includes a fixed shelf located at the bottom of the center storage area. No intermittent shelf. See pages 302-303 for optional Stack-on Storage. | | | | | | | |
| | Credenza with Kneespace, file/file | | | | | | |
| | 72"W x 24"D x 29½"H | 3½" | H105900 | 274 | 34.8 | \$1583 | \$1643 |
| | 66"W x 24"D x 29½"H | 3½" | H105901 | 262 | 32.0 | \$1567 | \$1627 |
| | 60"W x 24"D x 29½"H | 3½" | H105902 | 248 | 29.2 | \$1509 | \$1564 |
| NOTES: All drawers lock. One cord pass-through grommet in top center of modesty panel to reach wall electrical outlets. Not designed for use with 22¾"D modular or mobile pedestals. Modesty/back panel is inset 3½". See pages 302-303 for optional Stack-on Storage. | | | | | | | |
| | Single Pedestal Credenza, file/file | | | | | | |
| | 72"W x 24"D x 29½"H, Right (shown) | 3½" | H105903R | 226 | 34.8 | \$1283 | \$1338 |
| | 72"W x 24"D x 29½"H, Left | 3½" | H105904L | 226 | 34.8 | \$1283 | \$1338 |
| NOTES: Drawers lock. One cord pass-through grommet in top center of modesty panel to reach wall electrical outlets. Not designed for use with 22¾"D modular or mobile pedestals. Modesty/back panel is inset 3½". See pages 302-303 for optional Stack-on Storage. | | | | | | | |
| | Low Credenza | | | | | | |
| | 72"W x 20"D x 21½"H, Drawers Right, Bookcase Left | | H105975R | 219 | 23.5 | \$1404 | \$1464 |
| | 72"W x 20"D x 21½"H, Drawers Left, Bookcase Right | | H105976L | 219 | 23.5 | \$1404 | \$1464 |
| | 60"W x 20"D x 21½"H, Drawers Right, Bookcase Left | | H105973R | 187 | 19.7 | \$1293 | \$1348 |
| | 60"W x 20"D x 21½"H, Drawers Left, Bookcase Right | | H105974L | 187 | 19.7 | \$1293 | \$1348 |
| NOTES: Combines with overlapping, 29½"H worksurfaces to create a multi-level workstation for a modern aesthetic. For use in open plan spaces or private offices. Two locking drawers (1 box and 1 file) and open shelving. File drawers include integrated handrails for letter- or legal-sized folders. Bookcase has one adjustable shelf; adjusts in 1¼" increments with a range of 6". Overlapping surfaces can be supported by a 28½"H H-leg or O-leg, or 7"H O-leg, or by 7"H laminate end panel. On 60"W models, grain on back panel runs vertical for all woodgrain laminates. On 72", grain on back panel runs vertical for L1 woodgrains except for Florence and Kingswood Walnuts and horizontal on L2 laminates and Florence and Kingswood Walnuts. Optional seat cushions HSL2036CH2 for 72"W and HSL2030CH2 for 60"W. | | | | | | | |

NOTES:

- Factory-configured desks, credenzas and returns ship fully assembled for ease and speed of installation.
 - Formal, full-length modesty panels.
 - Tops are easy-care, scratch-, spill- and stain-resistant laminate over 1/8" solid core high-performance particleboard.
 - 3" round cord management grommets, for routing and hiding wires and cables, are located in the tops of desks, returns, bridges, and corner units. Grommet cutout accepts optional Power Hub (model HGRMTAC) or Power/USB Hub (model HGRMTUSB2) — see page 324.
 - Drawers operate on full extension, ball-bearing suspensions to ensure smooth, quiet, long-lasting operation.
 - All drawers are five-sided construction for added strength and easy alignment or replacement of drawer fronts.
 - File drawer design includes integrated handrails for side-to-side letter or legal filing; and front-to-back for letter filing.
 - For field installable decorative handle options, see page 322.
 - 10500 Series™ 18¾"D modular and mobile pedestals can be positioned under credenza with kneespace and single pedestal credenza models.
- Keyed alike cores must be ordered separately — see model HF23B on page 773 — makes re-keying quick and easy.

HOW TO SPECIFY

| | |
|--|--|
| Select Model Number | Select Laminate Top and Chassis Color See pages 266-267 Kickplates will match chassis color |
| <input type="text" value="H105905R."/> | <input type="text" value="NN"/> |

10500 SERIES™

Laminate Wood Desks — Full Pedestals

OPEN MARKET

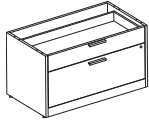

Icon Legend on page 19

**DESCRIPTION****2-Drawer Credenza, No Top**

36"W x 24"D x 19⁷/₈"H
 36"W x 20"D x 19⁷/₈"H
 30"W x 24"D x 19⁷/₈"H
 30"W x 20"D x 19⁷/₈"H

MODEL

H105LC3624BF
H105LC3620BF
H105LC3024BF
H105LC3020BF

SHIP WEIGHT**CUBE****L1 LIST****L2 UPCHARGES**
CHASSIS **FRONTS**

| | | | | |
|-------|------|-------|------|------|
| 105.5 | 13.9 | \$557 | \$35 | \$20 |
| 97.9 | 11.7 | \$557 | \$30 | \$20 |
| 92.3 | 11.7 | \$590 | \$30 | \$15 |
| 85.4 | 9.9 | \$536 | \$25 | \$15 |

NOTES: Use in conjunction with Modular Credenza tops on page 295.

① Keyed alike cores must be ordered separately — see model HF23B on page 773 — makes re-keying quick and easy.

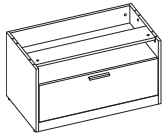
**Open/Lateral Credenza, No Top**

36"W x 24"D x 19⁷/₈"H
 36"W x 20"D x 19⁷/₈"H
 30"W x 24"D x 19⁷/₈"H
 30"W x 20"D x 19⁷/₈"H

H105LC3624SF
H105LC3620SF
H105LC3024SF
H105LC3020SF

| | | | | |
|-------|------|-------|------|------|
| 117.2 | 13.9 | \$536 | \$35 | \$20 |
| 106.1 | 11.7 | \$536 | \$30 | \$20 |
| 101.7 | 11.7 | \$520 | \$30 | \$15 |
| 91.8 | 9.9 | \$520 | \$25 | \$15 |

NOTES: Use in conjunction with Modular Credenza tops on page 295. Drawer is non-locking.

**DESCRIPTION****Open HAT Credenza, No Top**

36"W x 24"D x 19⁷/₈"H
 36"W x 20"D x 19⁷/₈"H
 30"W x 24"D x 19⁷/₈"H
 30"W x 20"D x 19⁷/₈"H

MODEL

H105LCHAT3624S
H105LCHAT3620S
H105LCHAT3024S
H105LCHAT3020S

SHIP WEIGHT**CUBE****LIST PRICE BY LAMINATE GRADE**
L1 **L2**

| | | | |
|------|------|-------|-------|
| 82.3 | 13.9 | \$255 | \$290 |
| 71.2 | 11.7 | \$255 | \$285 |
| 72.2 | 11.7 | \$234 | \$264 |
| 62.3 | 9.9 | \$234 | \$259 |

NOTES: False back allows HAT base leg to be concealed. Use in conjunction with Modular Credenza tops with HAT cutout on page 295.

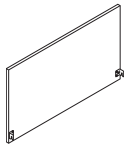
**Back for Open Storage Cabinet**

36"W x 19⁷/₈"H
 30"W x 19⁷/₈"H

H105LCHAT3620B
H105LCHAT3020B

25.0 2.1
 25.0 1.8

\$234 **\$249**
\$212 **\$227**

NOTES: Optional model to conceal HAT base leg when used in open office settings. Use with Open HAT Credenzas, No Top when the back of the unit will be visible in an open plan office.

NOTES:

- Units can be combined to create 60"W, 66"W, and 72"W low credenzas utilizing Modular Credenzas.
- Units have unfinished tops.
- File drawers include integrated hangrails for letter- or legal-sized folders.
- Open Credenzas have one adjustable shelf; adjusts 1¹/₄" increments with a range of 6".
- Overlapping surfaces can be supported by a 28¹/₂"H or 7"H O-leg or by 7"H laminate end panel.

HOW TO SPECIFY**Select Model Number**

H105LC3620BF

Select Chassis Laminate

See page 266
 Kickplates will match chassis color

LFW1

Select Door Front Laminate

See page 266

LFW1

Select Pull and Color

L Linear
 P Black

LP

Select Lock Option

Only available on
 2-Drawer Credenzas

L

Select Model Number

H105LCHAT3620B

Select Chassis Laminate

See page 266
 Kickplates will match chassis color

LFW1



10500 SERIES™ Laminate Wood Desks — Full Pedestals

| | DESCRIPTION | MODEL | SHIP WEIGHT | CUBE | LIST PRICE BY LAMINATE GRADE | | |
|-------------------|--|------------------------------|-----------------------|------|------------------------------|-------|-------|
| | | | | | L1 | L2 | |
| | Modular Credenza Tops, Height Adjustable Base | | | | | | |
| | 30"W x 24"D, Non-handed | H105CTHAT3024 | 23.5 | 2.3 | \$419 | \$434 | |
| | 30"W x 20"D, Non-handed | H105CTHAT3020 | 19.6 | 1.9 | \$419 | \$434 | |
| | 72"W x 24"D, Right | H105CTHAT7224R | 72.3 | 5.0 | \$851 | \$871 | |
| | 72"W x 20"D, Right | H105CTHAT7220R | 72.3 | 4.2 | \$851 | \$871 | |
| | 66"W x 24"D, Right | H105CTHAT6624R | 66.3 | 4.6 | \$789 | \$809 | |
| | 66"W x 20"D, Right | H105CTHAT6620R | 60.3 | 3.9 | \$789 | \$809 | |
| | 60"W x 24"D, Right | H105CTHAT6024R | 60.3 | 4.2 | \$724 | \$744 | |
| | 60"W x 20"D, Right | H105CTHAT6020R | 66.3 | 3.6 | \$724 | \$744 | |
| | 36"W x 24"D, Right | H105CTHAT3624R | 36.1 | 2.6 | \$525 | \$540 | |
| | 36"W x 20"D, Right | H105CTHAT3620R | 36.1 | 2.3 | \$525 | \$540 | |
| | | 72"W x 24"D, Left | H105CTHAT7224L | 72.3 | 5.0 | \$851 | \$871 |
| | | 72"W x 20"D, Left | H105CTHAT7220L | 72.3 | 4.2 | \$851 | \$871 |
| 66"W x 24"D, Left | | H105CTHAT6624L | 66.3 | 4.6 | \$789 | \$809 | |
| 66"W x 20"D, Left | | H105CTHAT6620L | 66.3 | 3.9 | \$789 | \$809 | |
| 60"W x 24"D, Left | | H105CTHAT6024L | 60.3 | 4.2 | \$724 | \$744 | |
| 60"W x 20"D, Left | | H105CTHAT6020L | 60.3 | 3.6 | \$724 | \$744 | |
| 36"W x 24"D, Left | | H105CTHAT3624L | 36.1 | 2.6 | \$525 | \$540 | |
| 36"W x 20"D, Left | | H105CTHAT3620L | 36.1 | 2.3 | \$525 | \$540 | |
| | | Modular Credenza Tops | | | | | |
| | | 30"W x 20"D | H105CT3020 | 19.6 | 1.9 | \$419 | \$434 |
| | 36"W x 20"D | H105CT3620 | 36.1 | 2.3 | \$525 | \$540 | |
| | 30"W x 24"D | H105CT3024 | 23.5 | 2.3 | \$419 | \$434 | |
| | 36"W x 24"D | H105CT3624 | 36.1 | 2.6 | \$525 | \$540 | |

NOTES:

- Easy care, scratch-, spill- and stain-resistant laminate over 1/8" solid core high-performance particleboard.
- Grain direction on all worksurfaces runs horizontal.
- Tops are intended to be used with modular low credenzas on page 294.
- Tops come with hardware to attach to low credenzas.
- Tops have a right or left notch to accommodate HON's Height Adjustable Base legs.

| | DESCRIPTION | MODEL | SHIP WEIGHT | CUBE | LIST PRICE BY FABRIC GRADE | | | | | |
|--|---|---------------------|-------------|------|----------------------------|-------|-------|-------|-------|-------|
| | | | | | 1 | 2 | 3 | 4 | 5 | 6 |
| | Fabric Credenza Tops | | | | | | | | | |
| | 36"W x 24"D x 1"H for 36"W Credenzas | HLAMSEAT3624 | 12 | 2.6 | \$462 | \$500 | \$538 | \$576 | \$614 | \$652 |
| | 30"W x 24"D x 1"H for 36"W Credenzas | HLAMSEAT3024 | 10 | 2.3 | \$430 | \$466 | \$502 | \$538 | \$574 | \$610 |
| | 36"W x 20"D x 1"H for 72"W Credenzas | HLSL2036CH2 | 11 | 2.2 | \$451 | \$489 | \$527 | \$566 | \$615 | \$665 |
| | 36"W x 20"D x 1"H for 60"W Credenzas | HLSL2030CH2 | 9 | 1.9 | \$418 | \$454 | \$490 | \$526 | \$572 | \$619 |
| | NOTES: See pages 22-24 for available fabrics. | | | | | | | | | |
| | COM: .75 | | | | | | | | | |
| | SPECIFYING EXAMPLE: HLAMSEAT3624.APN23 | | | | | | | | | |

HOW TO SPECIFY

| | |
|---|--|
| <p>Select Model Number</p> <p>H 1 0 5 C T H A T 3 6 2 0 .</p> | <p>Select Laminate and Edge Color</p> <p>See page 266</p> <p>L F W 1 F W</p> |
|---|--|

10500 SERIES™

Laminate Wood Desks — 3/4 Pedestals

GSA SIN 33721



Icon Legend on page 19

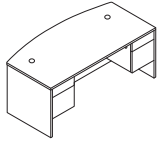

| DESCRIPTION | FULL WIDTH OVERHANG | MODEL | SHIP WEIGHT | CUBE | LIST PRICE BY LAMINATE GRADE | |
|---|---------------------|-----------------|-------------|------|------------------------------|---------------|
| | | | | | L1 | L2 |
| Double Pedestal Desk | | | | | | |
| 72"W x 36"D x 29½"H, Bow Top, 2-2 | 10½" | H10595 | 300 | 52.9 | \$1654 | \$1734 |
| 72"W x 36"D x 29½"H, Rectangle Top, 2-2 | 10½" | H10593 Ⓞ | 320 | 52.9 | \$1475 | \$1550 |
| 66"W x 30"D x 29½"H, Rectangle Top, 2-2 | 4½" | H10571 | 286 | 40.9 | \$1350 | \$1415 |
| 60"W x 30"D x 29½"H, Rectangle Top, 2-2 | 4½" | H10573 Ⓞ | 271 | 37.4 | \$1243 | \$1303 |

NOTES: All drawers lock. Two cord grommets in top for routing and hiding wires and cables. Bow top models measure 36"D at crest and 30"D along the end panels. See page 325 for optional center drawers.

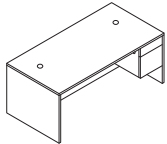

| | | | | | | |
|---|------|------------------|-----|------|---------------|---------------|
| Single Pedestal Desk | | | | | | |
| 72"W x 36"D x 29½"H, Bow Top, Right | 10½" | H10587R | 238 | 52.9 | \$1428 | \$1498 |
| 72"W x 36"D x 29½"H, Rectangle Top, Right | 10½" | H10585R | 279 | 52.9 | \$1253 | \$1318 |
| 66"W x 30"D x 29½"H, Rectangle Top, Right | 4½" | H10583R Ⓞ | 229 | 41.0 | \$1102 | \$1157 |
| 72"W x 36"D x 29½"H, Bow Top, Left | 10½" | H10588L | 238 | 52.9 | \$1428 | \$1498 |
| 72"W x 36"D x 29½"H, Rectangle Top, Left | 10½" | H10586L | 279 | 52.9 | \$1253 | \$1318 |
| 66"W x 30"D x 29½"H, Rectangle Top, Left | 4½" | H10584L Ⓞ | 229 | 41.0 | \$1102 | \$1157 |

NOTES: Box/file drawers. Drawers lock. Two cord grommets in top for routing and hiding wires and cables. Bow top models measure 36"D at crest and 30"D along the end panels. See page 325 for optional center drawers.

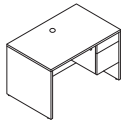

| | | | | | | |
|---|-----|-----------------|-----|------|--------------|---------------|
| Small Office Desk | | | | | | |
| 48"W x 30"D x 29½"H, 3/4 Pedestal, Right box/file | 4½" | H105885R | 168 | 30.5 | \$979 | \$1019 |

NOTES: Small footprint makes this desk ideal for limited space. Drawers lock. One cord grommet in top for routing and hiding wires and cables. 3/4 height modesty panel facilitates reaching wall electrical outlets. Optional stack-on storage model H105323 maximizes storage space; see page 302.

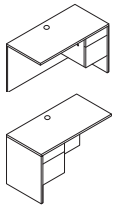

| | | | | | | |
|----------------------------|--|------------------|-----|------|--------------|--------------|
| Return, box/file | | | | | | |
| 48"W x 24"D x 29½"H, Right | | H10515R Ⓞ | 147 | 25.6 | \$888 | \$928 |
| 42"W x 24"D x 29½"H, Right | | H10511R | 138 | 20.5 | \$869 | \$909 |
| 48"W x 24"D x 29½"H, Left | | H10516L Ⓞ | 147 | 25.6 | \$888 | \$928 |
| 42"W x 24"D x 29½"H, Left | | H10512L | 138 | 20.5 | \$869 | \$909 |

NOTES: Return is for use with single pedestal desks, desk shells, peninsulas or corner units. One worksurface grommet and one cord pass-through grommet in top center of modesty panel to reach wall electrical outlets. Drawers lock. See pages 302-303 for optional stack-on storage.

ⓘ Not designed to be used freestanding. Will not attach to Corner Units manufactured prior to 5/24/99.

NOTES:

- For components that can be shared with 10500 Series™, see pages 298-325.
- Tops and end panels are abrasion- and stain-resistant laminate over durable 1½" solid core high-performance particleboard; resists warping.
- Formal, full height modesty panels.
- 3/4 pedestal design increases budget flexibility.
- 3" round cord management grommets, for routing and hiding wires and cables, are located in the tops of desks, returns, bridges, and corner units. Grommet cutout accepts optional Power Hub (model HGRMTAC) or Power/USB Hub (model HGRMTUSB2) — see page 324.
- All drawers are 5-sided construction, which allows easy drawer alignment or replacement of drawer fronts.
- Drawers operate on full extension, ball-bearing suspensions to ensure smooth, quiet, long-lasting operation.
- File drawer design includes integrated hangrails for side-to-side letter or legal filing; and front-to-back for letter filing.
- For field installable decorative handle options, see page 322.
- Desk, credenza, and return models ship assembled.
- See stack-on storage and stack-on PC organizer options on pages 301-303.
- Use with Above Worksurface Privacy Screens. See page 288.

HOW TO SPECIFY

Select Model Number

H 1 0 5 9 5 .

Select Laminate Top and Chassis Color

See pages 266-267

N N



10500 SERIES™

Laminate Wood Desks — 3/4 Pedestals

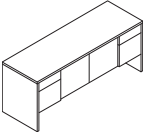
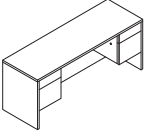
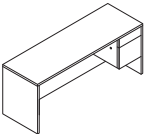
| | DESCRIPTION | FULL WIDTH OVERHANG | MODEL | SHIP WEIGHT | CUBE | LIST PRICE BY LAMINATE GRADE | |
|---|--|---------------------|---|-------------------|----------------------|---|---|
| | | | | | | L1 | L2 |
|  | Credenza with Doors 72"W x 24"D x 29½"H | 3½" | H10544 | 278 | 36.0 | \$1603 | \$1668 |
| NOTES: All drawers lock. Doors are non-locking. Includes a fixed shelf located at the bottom of the center storage area. No intermittent shelf. See pages 302-303 for optional stack-on storage. | | | | | | | |
|  | Credenza with Kneespace — box/file 72"W x 24"D x 29½"H 66"W x 24"D x 29½"H 60"W x 24"D x 29½"H | 3½" 3½" 3½" | H10543 ⓘ H10566 H10565 ⓘ | 243 234 229 | 36.3 33.4 28.8 | \$1315 \$1302 \$1243 | \$1375 \$1362 \$1298 |
| NOTES: All drawers lock. One cord pass-through grommet in top center of modesty panel to reach wall electrical outlets. ⓘ Not designed to be used with 22¾"D modular or mobile pedestals. Modesty/back panel is inset 3½". | | | | | | | |
|  | Single Pedestal Credenza — box/file 72"W x 24"D x 29½"H, Right (shown) 72"W x 24"D x 29½"H, Left | 3½" 3½" | H10545R H10546L | 212 212 | 36.0 36.0 | \$1085 \$1085 | \$1140 \$1140 |
| NOTES: Drawers lock. One cord pass-through grommet in top center of modesty panel to reach wall electrical outlets. See page 302 for optional stack-on storage. ⓘ Not designed to be used with 22¾"D modular or mobile pedestals. Modesty/back panel is inset 3½". | | | | | | | |

NOTES:

- For components that can be shared with 10500 Series™, see pages 298-325.
- Tops and end panels are abrasion- and stain-resistant laminate over durable 1½" solid core high-performance particleboard; resists warping.
- Formal, full height modesty panels.
- 3/4 pedestal design increases budget flexibility.
- 3" round cord management grommets, for routing and hiding wires and cables, are located in the tops of desks, returns, bridges, and corner units. Accepts optional Power Hub Grommet model HGRMTAC — page 324.
- All drawers are 5-sided construction, which allows easy drawer alignment or replacement of drawer fronts.
- Drawers operate on full extension, ball-bearing suspensions to ensure smooth, quiet, long-lasting operation.
- File drawer design includes integrated hangrails for side-to-side letter or legal filing; and front-to-back for letter filing.
- For field installable decorative handle options, see page 322.
- Desk, credenza, and return models ship assembled.
- See stack-on storage and stack-on PC organizer options on pages 301-303.
- Use with Above Worksurface Privacy Screens. See page 288.

HOW TO SPECIFY

| | |
|----------------------------|---|
| Select Model Number | Select Laminate Top and Chassis Color See pages 266-267 |
| H 1 0 5 4 4 . | N N |

10500 SERIES™

Shared Components & Accessories

GSA SIN 33721

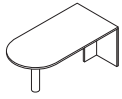

Icon Legend on page 19

**DESCRIPTION****Peninsula w/End Panel**

72"W x 36"D x 29½"H
72"W x 30"D x 29½"H
66"W x 30"D x 29½"H
60"W x 30"D x 29½"H

MODEL

H10521E
H105209E
H10522E
H10523E

SHIP WEIGHT

146
126
121
96

CUBE

8.1
7.0
6.6
6.6

LIST PRICE BY LAMINATE GRADE**L1**

\$930
\$869
\$857
\$803

L2

\$975
\$914
\$902
\$848

NOTES: Use for "U" or "L" configuration. 60"W size ideal for smaller spaces. Cord routing notch in brace panel. Accepts field installable modesty panel model H10528. Accepts center drawer model H1526 and H1522. Model H1522 can be used in conjunction with the laminate modesty panel model H10528. Round support column is black.

⚠ Not designed to be used freestanding.

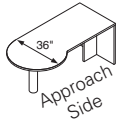

72"W x 30/36"D x 29½"H, P-shaped Right
72"W x 36/30"D x 29½"H, P-shaped Left

H10525RE
H10526LE

138
138

8.1
8.1

\$1088
\$1088

\$1133
\$1133

NOTES: Use for "U" or "L" configuration. Cord routing notch in brace panel. Accept field installable modesty panel model H10528 (see page 299). See page 325 for optional center drawers. Round support column is black.

⚠ Not designed to be used freestanding.

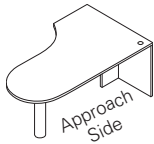

Right-hand model
H105201RE shown

Jetty Peninsula w/End Panel

72"W x 30/42"D x 29½"H, Right
72"W x 42/30"D x 29½"H, Left

H105201RE
H105202LE

152
152

9.4
9.4

\$1207
\$1207

\$1262
\$1262

NOTES: For use in "U" or "L" configuration. Designed and sized to efficiently serve as both a computing and conferencing space. One cord management grommet in the top; cord routing notch in brace panel. Round support column is black.

⚠ Not designed to be used freestanding. Jetty units manufactured on or after 10/24/2005 accept field installable modesty panel H10528 (see page 299).

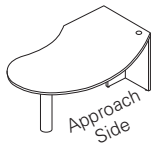
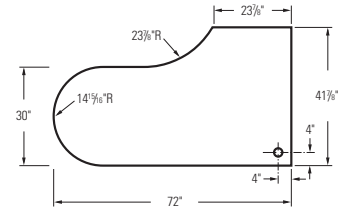

Right-hand model
H105203RE shown

Boomerang Peninsula w/End Panel

72"W x 30/42"D x 29½"H, Right
72"W x 42/30"D x 29½"H, Left

H105203RE
H105204LE

150
150

7.0
7.0

\$1207
\$1207

\$1262
\$1262

NOTES: For use in "U" or "L" configuration. Designed and sized to efficiently serve as both a computing and conferencing space. One cord management grommet in the top; cord routing notch in brace panel. Round support column is black.

⚠ Not designed to be used freestanding. Accept field installable modesty panel H10528 (see page 299).

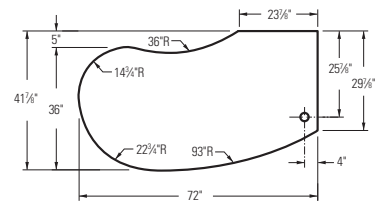
**NOTES:**

- Shared components shown on this page can be used with modular components shown on pages 274-291, full pedestal models shown on pages 292-293 and 3/4 pedestal models shown on pages 296-297.
- Jetty, boomerang, and rudder peninsulas are designed and sized to efficiently serve as both a computing and conferencing space.
- Peninsulas ship complete with end panel and black 3" diameter support column. For a silver support column option, please see model HPC191X on page 281 (ordered separately).
- Mobile pedestals shown on page 311 work well in a variety of configurations.
- Adjustable hex leveling glides allow floor-standing furniture to be easily leveled without lifting the unit; glides have 3/4" adjustable range.
- See pages 298-325 for shared components.

HOW TO SPECIFY**Select Model Number**

H 1 0 5 2 1 E .

Select Laminate Top and Chassis Color

See pages 266-267

N N .

Select Paint Color

Specify for new peninsula models only

P Black

P



10500 SERIES™

Shared Components & Accessories

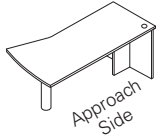

Model H105205RE shown

**DESCRIPTION****Rudder Peninsula with End Panel**

72"W x 30/38"D x 29½"H, Right
72"W x 30/38"D x 29½"H, Left

MODEL

H105205RE
H105206LE

SHIP WEIGHT

140
140

CUBE

8.1
8.1

LIST PRICE BY LAMINATE GRADE

L1 **L2**

\$1180 **\$1225**
\$1180 **\$1225**

NOTES: Use for "U" or "L" configuration. One cord management grommet in top; cord routing notch in brace panel. 30"D along end panel. Round support column is black.

ⓘ Not designed to be used freestanding.

**Field Installable Laminate Modesty Panel for Peninsulas**

50¼"W x ¾"Thick x 18"H

H10528

25

1.3

\$203

\$213

NOTES: Center drawer model H1522 can be used in conjunction with the laminate modesty panel. Laminate modesty panel has a cord pass-through notch in top corner.

ⓘ Not compatible with Peninsula models H10525R, H10526L, H10621 manufactured prior to 12/1/2001 or jetty models H105201R and H105202L manufactured prior to 10/24/2005.

SPECIFYING EXAMPLE: H10528.N

DESCRIPTION**Field Installable Modesty Panel, Frosted with Silver Frame**

50¼"W x ¾"Thick x 18"H — for use on 72"W peninsulas

MODEL

HPC180G

SHIP WEIGHT

33 Ⓞ

CUBE

1.5

LIST PRICE

\$745

ⓘ Center drawers not designed to be used with the frosted/silver modesty panel. Cord pass-through notch is not available on the Frosted/Silver model HPC180G. Notch is on laminate model H10528 only.

NOTES:**Panels**

- Shared components shown on this page can be used with modular components shown on pages 274-291, full pedestal models shown on pages 292-293 and 3/4 pedestal models shown on pages 296-297.
- Jetty, boomerang and rudder peninsulas are designed and sized to efficiently serve as both a computing and conferencing space.
- Peninsulas ship complete with end panel and black 3" diameter support column. For a silver support column option, please see model HPC191X on page 281 (ordered separately).
- Mobile pedestals shown on page 311 work well in a variety of configurations.
- Adjustable hex leveling glides allow floor-standing furniture to be easily leveled without lifting the unit; glides have ¾" adjustable range.
- See pages 298-325 for shared components.

HOW TO SPECIFY**Select Model Number**

H 1 0 5 2 0 5 R E

Select Laminate Top and Chassis Color

See pages 266-267

N N

Select Paint Color

Specify for new peninsula models only

P Black

P

10500 SERIES™

Shared Components & Accessories

GSA SIN 33721



Icon Legend on page 19



| DESCRIPTION | MODEL | SHIP WEIGHT | CUBE | LIST PRICE BY LAMINATE GRADE | |
|---|----------------|-------------|------|------------------------------|--------------|
| | | | | L1 | L2 |
| Bridge (Single Ped. Desk, Desk Shell, or Peninsula, to Corner Unit, Single Ped. Credenza or Credenza Shell) | | | | | |
| 47"W x 24"D x 29½"H (Clear inside depth = 21⅞"D) | H10570 | 76 | 2.8 | \$386 | \$416 |
| 42"W x 24"D x 29½"H (Clear inside depth = 21⅞"D) | H10560 | 72 | 2.6 | \$371 | \$401 |
| Bridge (for use with Corner or Extended Corner Units or Jetty or Boomerang Peninsulas) | | | | | |
| 36"W x 24"D x 29½"H (Clear inside depth = 21⅞"D) | H105599 | 61 | 2.6 | \$371 | \$401 |
| Bridge (for use with Corner or Extended Corner Units) | | | | | |
| 30"W x 24"D x 29½"H (Clear inside depth = 21⅞"D) | H105598 | 50 | 1.9 | \$371 | \$401 |
| NOTES: One cord grommet in top; one pass-through grommet in top center of modesty panel. Grommet can be replaced with optional Power Hub or Power/USB Hub for easy plug-and-play (see page 324). Kneespace of desk limited to 24¾"W if bridge is used with 66"W single pedestal desk. | | | | | |
| ⓘ Not designed to attach to corner units manufactured prior to 5/24/99. | | | | | |
| Bridge (Single Ped. Desk, Desk Shell, or Peninsula to Single Ped. Credenza or Credenza Shell) | | | | | |
| 47"W x 20"D x 29½"H (Clear inside depth = 17⅞"D) | H105699 | 61 | 2.8 | \$371 | \$401 |
| 42"W x 20"D x 29½"H (Clear inside depth = 17⅞"D) | H105698 | 54 | 2.6 | \$345 | \$375 |
| NOTES: One cord grommet in top; one pass-through grommet in top center of modesty panel. | | | | | |
| ⓘ Models H105699 and H105698 cannot be connected to corner or extended corner units or to the jetty or boomerang peninsulas, due to the 20"D "hook-up". | | | | | |

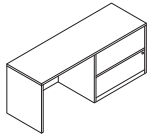

| | | | | | |
|---|----------------|-----|------|---------------|---------------|
| Credenza with 36" Lateral (with core removable lock) | | | | | |
| 72"W x 24"D x 29½"H, Right (shown) | H10547R | 248 | 35.6 | \$1484 | \$1544 |
| 72"W x 24"D x 29½"H, Left | H10548L | 248 | 35.6 | \$1484 | \$1544 |
| NOTES: One cord pass-through grommet in top center of modesty panel. Includes hangrails. Mechanical interlock inhibits the extension of more than one drawer at a time. Accepts optional stack-on storage model H10534 (page 302) or PC Organizer model H105388 (page 301). | | | | | |
| ⓘ Not designed to be used with 10500 Series™ 22¾"D modular or mobile pedestals. Modesty/back panel is inset 3½". | | | | | |

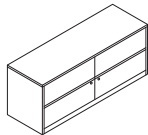

| | | | | | |
|--|----------------|-----|------|---------------|---------------|
| Credenza with two Lateral Files (4 locking drawers. Each core removable lock secures 2 drawers) | | | | | |
| 72"W x 24"D x 29½"H | H105491 | 314 | 34.7 | \$2143 | \$2218 |
| NOTES: Includes hangrails; mechanical interlock inhibits the extension of more than one drawer at a time. If side-by-side drawers are opened or closed simultaneously, one drawer may interfere with the other. Two locks (keyed alike). Accepts optional stack-on storage model H10534 (page 302) or PC Organizer model H105388 (page 301). | | | | | |

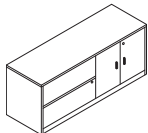

| | | | | | |
|--|----------------|-----|------|---------------|---------------|
| Credenza with Lateral File, left and Storage Cabinet, right (with core removable locks) | | | | | |
| 72"W x 24"D x 29½"H | H105492 | 307 | 34.7 | \$1875 | \$1950 |
| NOTES: Includes hangrails; mechanical interlock inhibits the extension of more than one drawer at a time. Storage cabinet locks and includes one adjustable interior shelf. Shelf adjusts in ¼" increments with a total range of 5"H. Two locks (keyed alike). Accepts optional stack-on storage model H10534 (page 302) or PC Organizer model H105388 (page 301). | | | | | |

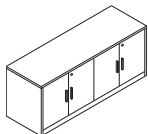

| | | | | | |
|--|----------------|-----|------|---------------|---------------|
| Credenza with Two Storage Cabinets (with core removable locks) | | | | | |
| 72"W x 24"D x 29½"H | H105493 | 302 | 34.8 | \$1747 | \$1822 |
| NOTES: Each storage cabinet has one interior shelf which adjusts in ¼" increments over a total range of 5". Each cabinet locks independently; locks are keyed alike. Accepts optional stack-on storage model H10534 (page 302) or PC Organizer model H105388 (page 301). | | | | | |

NOTES:

- Shared components shown on this page can be used with modular components shown on pages 274-291, full pedestal models shown on pages 292-293, and 3/4 pedestal models shown on pages 296-297.
- Locking units equipped with interchangeable core removable locks.
- File drawers accept hanging folders in letter or legal size.
- Mobile pedestals shown on page 311 work well in a variety of configurations.
- Work Organizer models accept 3-ring binders and organizer model HTC052. See page 317.
- See stack-on storage and organizer options for desks, credenzas and returns, pages 301-303.
- See pages 298-325 for shared components.

ⓘ Keyed alike cores must be ordered separately — see model HF23B on page 773.

HOW TO SPECIFY

Select
Model Number

H 1 0 5 7 0 .

Select
Laminate Top and Chassis Color

See pages 266-267

N N



Icon Legend on page 19

10500 SERIES™

Shared Components & Accessories

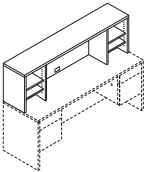
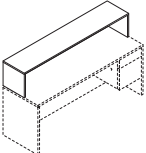
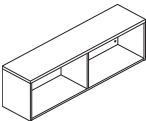
| | DESCRIPTION | MODEL | SHIP | | LIST PRICE BY LAMINATE GRADE | |
|---|--|----------------|--------|------|------------------------------|--------------|
| | | | WEIGHT | CUBE | L1 | L2 |
|  | Stack-on PC Organizer | | | | | |
| | 72"W x 14 ⁵ / ₈ "D x 22"H (for 72"W desks, credenzas and shells) | H105388 | 124 | 5.0 | \$863 | \$898 |
| | 60"W x 14 ⁵ / ₈ "D x 22"H (for 60"W desks, credenzas and shells) | H105386 | 111 | 4.3 | \$801 | \$836 |
| | NOTES: Features two adjustable paper management shelves both left and right; shelves are adjustable in 1/4" increments. Shelves keep papers, files, and books within easy reach from a seated position. One cord management grommet located in the bottom center of the back panel. Design allows 20 ³ / ₄ " of vertical clearance for computer equipment. | | | | | |
|  | Work Organizer (shell only) | | | | | |
| | 72"W x 14 ⁵ / ₈ "D x 14 ¹ / ₈ "H (for 72"W unit) | H10537 | 73 | 2.9 | \$447 | \$477 |
| | 66"W x 14 ⁵ / ₈ "D x 14 ¹ / ₈ "H (for 66"W unit) | H10536 | 68 | 2.7 | \$424 | \$454 |
| | NOTES: Space below counter accepts 3-ring binders and organizer model HTC0L52. See page 317. | | | | | |
|  | Open Shared Storage | | | | | |
| | 60"W x 14 ⁵ / ₈ "D x 16 ⁷ / ₈ "H | H105368 | 81 | 14.2 | \$816 | \$846 |
| | 48"W x 14 ⁵ / ₈ "D x 16 ⁷ / ₈ "H | H105367 | 68 | 11.5 | \$794 | \$819 |
| | NOTES: Attaches to laminate end panels with horizontally mounted interlocking brackets. Mounting applications include: 60"W — two 30"D desks/desk shells, 60"W — two 48"W (minimum) x 30"D rectangle worksurfaces supported by 28 ¹ / ₂ "H L-shaped end panels, 48"W — two 24"D credenzas/credenza shells, 48"W — two 24"D returns/return shells, 48"W — two 60"W (minimum) x 24"D rectangle worksurfaces supported by 28 ¹ / ₂ "H L-shaped end panels. Can also be positioned on the worksurface; double-sided tape included. Grain direction is vertical on top, back, end panels, and shelf. Ships fully assembled. Not designed for attachment to a worksurface supported by H-legs or O-legs. Inside dimensions for 60"W: each compartment 28 ³ / ₄ "W x 13 ¹ / ₂ "D x 15 ¹ / ₂ "H. Inside dimensions for 48"W: each compartment 22 ³ / ₄ "W x 13 ¹ / ₂ "D x 15 ¹ / ₂ "H. | | | | | |

NOTES:

- Shared components shown on this page can be used with modular components shown on pages 274-291, full pedestal models shown on pages 292-293, and 3/4 pedestal models shown on pages 296-297.
 - Mobile pedestals shown on page 311 work well in a variety of configurations.
 - See stack-on storage and organizer options for desks, credenzas and returns, pages 301-303.
 - See pages 298-325 for shared components.
 - Locking units equipped with interchangeable core removable locks.
- ① Keyed alike cores must be ordered separately — see model HF23B on page 773.

HOW TO SPECIFY

| | |
|---|--|
| Select Model Number H 1 0 5 3 8 8 | Select Laminate Top and Chassis Color See pages 266-267 N N |
|---|--|

10500 SERIES™

Shared Components & Accessories

GSA SIN 33721



Icon Legend on page 19

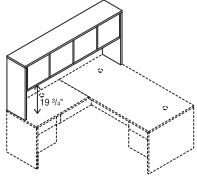

| DESCRIPTION | MODEL | SHIP | | LIST PRICE BY LAMINATE GRADE | |
|--|-----------------|--------|------|------------------------------|---------------|
| | | WEIGHT | CUBE | L1 | L2 |
| Stack-on Storage for an "L" Workstation 78"W x 14 ⁵ / ₈ "D x 37 ¹ / ₈ "H | H105327 | 198 | 17.6 | \$1213 | \$1278 |
| Stack-on Storage for an "L" Workstation, Locking | H105327K | 198 | 17.6 | \$1302 | \$1367 |

NOTES: Spans the total depth dimension of configurations comprised of: 48"W return or return shell attached to a 30"D single pedestal desk, desk shell or peninsula (78"D); 42"W return or return shell attached to a 36"D single pedestal desk or desk shell with a rectangle top, or to a peninsula (78"D). 42"W return or return shell attached to a 36" corner unit (78"D); or 42"W curved return attached to 36" curved corner unit (78"D). Use back enclosure model H105857 and tackboard model H90057. Use task light models HH870960 or HH870960CH (see page 595). For vertical paper manager model HLVPM1, see page 319.

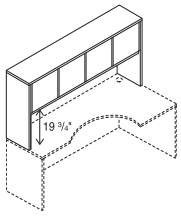

| | | | | | |
|---|-----------------|-----|------|---------------|---------------|
| Stack-on Storage 72"W x 14 ⁵ / ₈ "D x 37 ¹ / ₈ "H, 4 doors (Use Task Light HH870960, see page 309) | H10534 | 185 | 17.1 | \$1072 | \$1112 |
| 66"W x 14 ⁵ / ₈ "D x 37 ¹ / ₈ "H, 4 doors (Use Task Light HH870960, see page 309) | H10533 | 175 | 15.3 | \$1042 | \$1097 |
| 60"W x 14 ⁵ / ₈ "D x 37 ¹ / ₈ "H, 4 doors (Use Task Light HH870960, see page 309) | H105324 | 164 | 14.0 | \$1000 | \$1055 |
| 48"W x 14 ⁵ / ₈ "D x 37 ¹ / ₈ "H, 3 doors (Use Task Light HH870942, see page 309) | H105323 | 141 | 11.3 | \$901 | \$946 |
| 42"W x 14 ⁵ / ₈ "D x 37 ¹ / ₈ "H, 2 doors (Use Task Light HH870942, see page 309) | H105322 | 135 | 4.0 | \$738 | \$783 |
| 36"W x 14 ⁵ / ₈ "D x 37 ¹ / ₈ "H, 2 doors (Use Task Light HH870930, see page 309) | H105321 | 102 | 3.5 | \$697 | \$727 |
| Stack-on Storage, Locking | | | | | |
| 72"W x 14 ⁵ / ₈ "D x 37 ¹ / ₈ "H, 4 doors (Use Task Light HH870960, see page 309) | H10534K | 185 | 17.1 | \$1161 | \$1216 |
| 66"W x 14 ⁵ / ₈ "D x 37 ¹ / ₈ "H, 4 doors (Use Task Light HH870960, see page 309) | H10533K | 175 | 15.3 | \$1132 | \$1187 |
| 60"W x 14 ⁵ / ₈ "D x 37 ¹ / ₈ "H, 4 doors (Use Task Light HH870960, see page 309) | H105324K | 164 | 14.0 | \$1089 | \$1144 |
| 48"W x 14 ⁵ / ₈ "D x 37 ¹ / ₈ "H, 3 doors (Use Task Light HH870942, see page 309) | H105323K | 141 | 11.3 | \$968 | \$1013 |
| 42"W x 14 ⁵ / ₈ "D x 37 ¹ / ₈ "H, 2 doors (Use Task Light HH870942, see page 309) | H105322K | 135 | 4.0 | \$783 | \$828 |
| 36"W x 14 ⁵ / ₈ "D x 37 ¹ / ₈ "H, 2 doors (Use Task Light HH870930, see page 309) | H105321K | 102 | 3.5 | \$741 | \$781 |

NOTES: For use on respective desk, credenza or return widths. Model H10534 can be used for "L" configuration comprised of 30"D desk, desk shell or peninsula and 42"W return or return shell; or a 36"D desk, desk shell, peninsula, or corner unit and 36"W return shell. Model H105323K has one lock which secures two of the three doors. See vertical paper manager model HLVPM1 on page 319.

NOTES:

- Shared components shown on this page can be used with modular components shown on pages 274-291, full pedestal models shown on pages 292-293, and 3/4 pedestal models shown on pages 296-297.
- Rich woodgrain laminate and frosted doors with silver frames adds a contemporary mixed materials option to the 10500 Series™.
- Stack-on storage models are equipped with self-closing, adjustable hinged doors and valance to hide task light.
- See page 305 for stack-on storage back enclosures and tackboards, and page 309 for task lights.
- For work-in-process paper management tools, see pages 319-320.
- See pages 298-325 for shared components.
- **Removable lock core kit for locking stack-on storage is model HF27B. See page 773.**

HOW TO SPECIFYSelect
Model Number

H 1 0 5 3 2 7

Select
Laminate Top and Chassis Color

See pages 266-267

N N



10500 SERIES™

Shared Components & Accessories

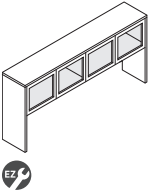
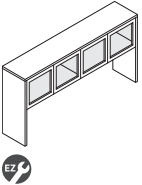
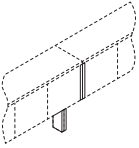
| | DESCRIPTION | MODEL | SHIP WEIGHT | CUBE | LIST PRICE BY LAMINATE GRADE | |
|--|--|-----------------|-------------|------|------------------------------|---------------|
| | | | | | L1 | L2 |
|  | Stack-on Storage for an "L" Workstation, Frosted Doors with Silver Frame 78"W x 14 ⁵ / ₈ "D x 37 ¹ / ₈ "H NOTES: Spans the total depth dimension of configurations comprised of: 48"W return or return shell attached to a 30"D single pedestal desk, desk shell or peninsula (78"D); 42"W return or return shell attached to a 36"D single pedestal desk or desk shell with a rectangle top, or to a peninsula (78"D); 42"W return or return shell attached to a 36" corner unit (78"D); 42"W curved return attached to 36" curved corner unit (78"D); or 36"W return shell attached to a jetty peninsula (78"D). Use back enclosure model H105857 and tackboard model H90057. Use task light models HH870960 or HH870960CH. For vertical paper manager model HLVP1, see page 319. | H105327G | 198 | 17.3 | \$1904 | \$1954 |
|  | Stack-on Storage, Frosted Doors with Silver Frame 72"W x 14 ⁵ / ₈ "D x 37 ¹ / ₈ "H, 4 doors (Use Task Light HH870960, see page 309) 66"W x 14 ⁵ / ₈ "D x 37 ¹ / ₈ "H, 4 doors (Use Task Light HH870960, see page 309) 60"W x 14 ⁵ / ₈ "D x 37 ¹ / ₈ "H, 4 doors (Use Task Light HH870960, see page 309) 48"W x 14 ⁵ / ₈ "D x 37 ¹ / ₈ "H, 3 doors (Use Task Light HH870942, see page 309) 42"W x 14 ⁵ / ₈ "D x 37 ¹ / ₈ "H, 2 doors (Use Task Light HH870942, see page 309) 36"W x 14 ⁵ / ₈ "D x 37 ¹ / ₈ "H, 2 doors (Use Task Light HH870930, see page 309) NOTES: For respective desk, credenza or return widths. Model 10534 can be used for "L" configuration comprised of a 42"W return or return shell attached to a 30"D single pedestal desk, desk shell or peninsula (72"); 36"W return shell attached to a 36"D single pedestal desk, desk shell or peninsula (72"); or 30"W return shell attached to a jetty peninsula (72"). Back enclosures, tackboards for use with back enclosures and task lights are available as options. See vertical paper manager model HLVP1 on page 319. | H10534G | 185 | 15.9 | \$1759 | \$1799 |
| | | H10533G | 175 | 14.6 | \$1728 | \$1768 |
| | | H105324G | 164 | 13.3 | \$1685 | \$1725 |
| | | H105323G | 141 | 10.8 | \$1419 | \$1449 |
| | | H105322G | 135 | 3.6 | \$1088 | \$1118 |
| | | H105321G | 102 | 3.1 | \$1045 | \$1070 |
|  | Stack-on Storage Clearance End Panel Kit 1 ¹ / ₈ "W x 4 ⁵ / ₈ -14 ⁵ / ₈ "D x 36"H Two field installable end panels (1-right; 1-left) for use in ganging two 10500 or Valido® Series stack-on storage units. Narrow design replaces the full 14 ⁵ / ₈ "D end panels to expand worksurface space. The narrow right end panel replaces the standard 14 ⁵ / ₈ "D right end panel on one stack-on storage unit, the narrow left end panel replaces the standard 14 ⁵ / ₈ "D left end panel on a separate, adjacent stack-on storage unit that is in linear alignment with the first unit. Kit includes: (2) narrow end panel supports; European-style fasteners; dowels; joint connector bolts with sleeve nuts (for ganging stack-on storage units). NOTES: Can be used to connect up to two stack-on storage units in a line (requires 1 kit). Not available in two-tone laminate. | H105349 | 29 | 3.4 | \$382 | \$397 |

NOTES:

- Shared components shown on this page can be used with modular components shown on pages 274-291, full pedestal models shown on pages 292-293, and 3/4 pedestal models shown on pages 296-297.
- Rich woodgrain laminate and frosted doors with silver frames adds a contemporary mixed materials option to the 10500 Series™.
- Stack-on storage models are equipped with self-closing, adjustable hinged doors and valance to hide task light.
- See page 305 for stack-on storage back enclosures and tackboards, and page 309 for task lights.
- For work-in-process paper management tools, see pages 319-320.
- See pages 298-325 for shared components.
- Removable lock core kit for locking stack-on storage is model HF27B. See page 773.**

HOW TO SPECIFY

| | |
|---|--|
| Select Model Number H 1 0 5 3 2 7 G . | Select Laminate Top and Chassis Color See pages 266-267 N N |
|---|--|

10500 SERIES™

Shared Components & Accessories

GSA SIN 33721



Icon Legend on page 19

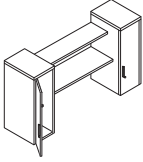

| DESCRIPTION | MODEL | SHIP WEIGHT | CUBE | L1 LIST | L2 UPCHARGES | |
|--|----------------|-------------|------|---------------|--------------|-------------|
| | | | | | CHASSIS | SHELF |
| Stack-on Cabinets with Open Shelves, Center Overall measures: 72"W x 20"D x 37 ¹ / ₈ "H Cabinet measures: 13 ¹ / ₂ "W x 19 ⁷ / ₈ "D x 37 ¹ / ₈ "H NOTES: Contemporary, light scale design blends open and closed storage. Features two locking cabinets bridged by two open shelves. The clearance between the worksurface and underside of the lower shelf is 18 ³ / ₈ ". Top shelf is 45"W x 11"D, bottom shelf is 45"W x 14"D; space between the shelves is 12 ¹ / ₄ ". Some assembly required; cabinets are fully assembled; simple shelf attachment. For two-tone color combinations, the first color designator defines the top of the storage cabinet(s), the second designator defines the color of the cabinet vertical panels and the open (exterior) shelves. | H105319 | 218 | 20.3 | \$1866 | \$60 | \$20 |

NOTES:

- Stack-on Cabinets with Open Shelves, Center is sized to fit on 72" desk, credenza, return, or desk with return worksurfaces.
- Easy-care, scratch-, spill- and stain-resistant laminate over 1/8" solid core high-performance particleboard.
- Cabinets have three shelves, two are adjustable.
- Removable lock core kit for the cabinet models above is HF23B. See page 773.
- Back of cabinet door has a convenient double coat hook; the lower peg is for jackets and lighter items, the upper peg for heavier coats and bags.
- Open shelves display books, photos, and mementos, shelves are fixed height; top shelf is 3/4" thick, lower shelf is 1/8".
- Task light can be attached to underside of the bottom shelf.

HOW TO SPECIFY

Select
Model Number

H 1 0 5 3 1 9 .

Select
Cabinet Top and Chassis Color

See pages 266-267

H H .

Select
Open Shelf Laminate

See pages 266-267

H



10500 SERIES™

Shared Components & Accessories

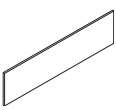
| | DESCRIPTION | MODEL | SHIP WEIGHT | CUBE | LIST PRICE BY LAMINATE GRADE | |
|--|--|------------------|-------------|--------------|------------------------------|--------------|
| | | | | | L1 | L2 |
|  <p>18 5/8" H</p> <p>Not available in two-tone laminate</p> | Back Enclosure for Stack-on Storage | | | | | |
| | 75 3/4" W - for 78" W model #H105327/H105327K/H105327G | H105857 | 39 | 1.4 | \$275 | \$285 |
| | 69 3/4" W - for 72" W model #H10534/H10534K/H10534G | H105856 ⓘ | 33 | 1.3 | \$252 | \$262 |
| | 63 3/4" W - for 66" W model #H10533/H10533K/H10533G | H105855 | 31 | 1.3 | \$235 | \$245 |
| | 57 3/4" W - for 60" W model #H105324/H105324K/H105324G | H105854 | 29 | 1.3 | \$224 | \$234 |
| | 45 3/4" W - for 48" W model #H105323/H105323K/H105323G | H105853 | 23 | 0.9 | \$224 | \$234 |
| | 39 3/4" W - for 42" W model #H105322/H105322K/H105322G | H105852 | 21 | 0.9 | \$214 | \$224 |
| 33 3/4" W - for 36" W model #H105321/H105321K/H105321G | H105851 | 18 | 0.9 | \$202 | \$212 | |

NOTES: Non-tackable.

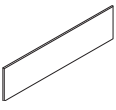
| | DESCRIPTION | MODEL | COM | SHIP WEIGHT | CUBE | LIST PRICE |
|--|---|---------------|-----|-------------|--------------|--------------|
| | | | | | | |
|  <p>18" H</p> | Tackboards for use with Stack-on Back Enclosures (Back Enclosures must be ordered separately.) | | | | | |
| | 75" W - for 78" W model #H105327 Hutch with #H105857 Enclosure | H90057 | 3.0 | 13 | 3.2 | \$337 |
| | 68 3/4" W - for 72" W model #H10534 Hutch with #H105856 Enclosure | H90056 | 2.0 | 12 | 2.7 | \$320 |
| | 62 3/4" W - for 66" W model #H10533 Hutch with #H105855 Enclosure | H90055 | 2.0 | 11 | 2.5 | \$304 |
| | 56 3/4" W - for 60" W model #H105324 Hutch with #H105854 Enclosure | H90054 | 2.0 | 10 | 2.2 | \$268 |
| | 44 3/4" W - for 48" W model #H105323 Hutch with #H105853 Enclosure | H90053 | 2.0 | 8 | 1.8 | \$257 |
| | 39" W - for 42" W model #H105322 Hutch with #H105852 Enclosure | H90052 | 2.0 | 7 | 1.6 | \$237 |
| | 33" W - for 36" W model #H105321 Hutch with #H105851 Enclosure | H90051 | 1.0 | 6 | 1.4 | \$208 |
| 26 3/4" W | H90050 | 1.0 | 5 | 1.2 | \$208 | |

NOTES: Specify fabric, see pages 25-26. Upcharges may apply to premium fabric grades.

ⓘ Disperse (DISP) fabric not available on sizes wider than 60". Analog (ANLG) and Exchange (EXG) not available on sizes wider than 72".

SPECIFYING EXAMPLE: H90057.APN15**NOTES:**

- When connected to the stack-on storage unit, back enclosure features full-width 1 1/8" slot at the bottom to facilitate routing cords and reaching wall electrical outlets.
- Tackboard is sized 3/4" narrower than stack-on storage back enclosure, allowing 3/8" on each side to route task light cord.
- Tackboard includes adhesive tape to secure to back enclosure and hardware for wall attachment.
- See pages 298-325 for shared components.

HOW TO SPECIFY

| | |
|---|--|
| Select Model Number <div style="border: 1px solid black; padding: 2px; display: flex; gap: 5px;"> H105857 </div> | Select Laminate See pages 266-267 <div style="border: 1px solid black; padding: 2px; display: flex; gap: 5px;"> N </div> |
|---|--|

10500 SERIES™

Shared Components & Accessories

GSA SIN 33721



Icon Legend on page 19

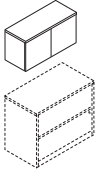

| DESCRIPTION | MODEL | SHIP | | LIST PRICE BY LAMINATE GRADE | |
|--|-----------------|--------|------|------------------------------|---------------|
| | | WEIGHT | CUBE | L1 | L2 |
| Wall Mounted Storage Cabinet 48"W x 14 ⁵ / ₈ "D x 17 ¹ / ₂ "H, 3 doors (Use task light model HH870942, see page 309) | H105383 | 114 | 13.2 | \$931 | \$966 |
| 42"W x 14 ⁵ / ₈ "D x 17 ¹ / ₂ "H, 2 doors (Use task light model HH870942, see page 309) | H105382 | 97 | 11.7 | \$871 | \$906 |
| 36"W x 14 ⁵ / ₈ "D x 17 ¹ / ₂ "H, 2 doors (Use task light model HH870930, see page 309) | H105381 | 87 | 10.2 | \$793 | \$828 |
| 30"W x 14 ⁵ / ₈ "D x 17 ¹ / ₂ "H, 2 doors (Use task light model HH870930, see page 309) | H105380 | 73 | 8.7 | \$739 | \$774 |
| Wall Mounted Storage Cabinet, Locking 48"W x 14 ⁵ / ₈ "D x 17 ¹ / ₂ "H, 3 doors (Use task light model HH870942, see page 309) | H105383K | 114 | 13.2 | \$998 | \$1033 |
| 42"W x 14 ⁵ / ₈ "D x 17 ¹ / ₂ "H, 2 doors (Use task light model HH870942, see page 309) | H105382K | 97 | 11.7 | \$915 | \$950 |
| 36"W x 14 ⁵ / ₈ "D x 17 ¹ / ₂ "H, 2 doors (Use task light model HH870930, see page 309) | H105381K | 87 | 10.2 | \$838 | \$873 |
| 30"W x 14 ⁵ / ₈ "D x 17 ¹ / ₂ "H, 2 doors (Use task light model HH870930, see page 309) | H105380K | 73 | 8.7 | \$784 | \$819 |

NOTES: Horizontal interlocking rails are included; due to varying types of walls, installers are responsible for selecting and supplying the appropriate fasteners. Tackboard widths differ slightly from wall mounted storage cabinet widths. For applications where multiple wall mounted storage cabinets are placed side-by-side, the preferred tackboard solution may be to utilize a larger tackboard size. For wall mounted storage cabinets with frosted doors, see page 309.

SPECIFYING EXAMPLE: H105380.NN
If Specifying with Lock Option: H105380K.NN

NOTES:

- Tackboard is sized ³/₄" narrower than stack-on storage back enclosure, allowing ³/₈" on each side to route task light cord.
- Wall attachment methodology: horizontally mounted, interlocking brackets.
- Wall mounted storage cabinet door design overlaps end panels so that when multiple units are placed side-by-side they appear as one continuous unit.
- Wall mounted storage cabinets available with laminate doors, locking laminate doors or frosted doors.
- Removable lock core kit for locking stack-on and wall mounted storage is model HF27B. See page 773.
- See pages 298-325 for shared components.

- ! Wall mounted storage cabinet attachment requires individual cabinets be secured by a minimum of two wall mounting locations/studs.
- ! Wall mounted storage cabinets are designed for interior and perimeter walls that are constructed with wood or metal studs.
- ! The HON Company is not responsible for any liabilities resulting from wall mounted storage cabinets that are not properly installed.

HOW TO SPECIFY

| | |
|----------------------------|--|
| Select Model Number | Select Laminate Top and Chassis Color |
| | See pages 266-267 |
| H 1 0 5 3 8 0 K . | N N |



Icon Legend on page 29

10500 SERIES™ Shared Components & Accessories

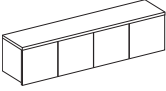
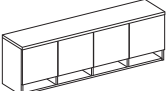
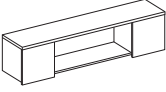
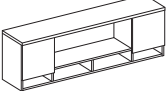
| | DESCRIPTION | MODEL | SHIP WEIGHT | CUBE | L1 LIST | L2 UPCHARGES | |
|---|--|--------------------|-------------|------|---------------|--------------|-------------|
| | | | | | | CHASSIS | FRONTS |
|  | Wall Mounted Hutch | | | | | | |
| | 66"W x 14 ⁵ / ₈ "D x 15"H, 4 doors | H105WMH66 | 120 | 16.1 | \$1359 | \$30 | \$30 |
| | 48"W x 14 ⁵ / ₈ "D x 15"H, 3 doors | H105WMH48 | 97 | 12.6 | \$974 | \$25 | \$30 |
| | 42"W x 14 ⁵ / ₈ "D x 15"H, 2 doors | H105WMH42 | 77 | 10.7 | \$913 | \$25 | \$20 |
| | 36"W x 14 ⁵ / ₈ "D x 15"H, 2 doors | H105WMH36 | 67 | 9.8 | \$836 | \$25 | \$20 |
| | 30"W x 14 ⁵ / ₈ "D x 15"H, 2 doors | H105WMH30 | 57 | 8.3 | \$782 | \$25 | \$20 |
|  | Wall Mounted Cubby Hutch | | | | | | |
| | 66"W x 14 ⁵ / ₈ "D x 20"H, 4 doors | H105WMH66C | 155 | 19.6 | \$1359 | \$30 | \$30 |
| | 48"W x 14 ⁵ / ₈ "D x 20"H, 3 doors | H105WMH48C | 128 | 15.2 | \$974 | \$25 | \$30 |
| | 42"W x 14 ⁵ / ₈ "D x 20"H, 2 doors | H105WMH42C | 114 | 13.0 | \$913 | \$25 | \$20 |
| | 36"W x 14 ⁵ / ₈ "D x 20"H, 2 doors | H105WMH36C | 89 | 11.8 | \$836 | \$25 | \$20 |
| | 30"W x 14 ⁵ / ₈ "D x 20"H, 2 doors | H105WMH30C | 76 | 10.0 | \$782 | \$25 | \$20 |
|  | Wall Mounted Open Hutch | | | | | | |
| | 72"W x 14 ⁵ / ₈ "D x 15"H, 2 Doors | H105WMH72P | 119 | 17.5 | \$1484 | \$35 | \$35 |
| | 66"W x 14 ⁵ / ₈ "D x 15"H, 2 Doors | H105WMH66P | 111 | 16.1 | \$1359 | \$30 | \$30 |
| | 60"W x 14 ⁵ / ₈ "D x 15"H, 2 Doors | H105WMH60P | 104 | 14.7 | \$1231 | \$30 | \$30 |
| | 48"W x 14 ⁵ / ₈ "D x 15"H, 2 Doors | H105WMH48P | 89 | 12.6 | \$1103 | \$25 | \$30 |
|  | Wall Mounted Open Hutch with Cubby | | | | | | |
| | 72"W x 14 ⁵ / ₈ "D x 20"H, 2 Doors | H105WMH72PC | 162 | 21.3 | \$1484 | \$35 | \$35 |
| | 66"W x 14 ⁵ / ₈ "D x 20"H, 2 Doors | H105WMH66PC | 151 | 19.6 | \$1359 | \$30 | \$30 |
| | 60"W x 14 ⁵ / ₈ "D x 20"H, 2 Doors | H105WMH60PC | 140 | 14.7 | \$1231 | \$30 | \$30 |
| | 48"W x 14 ⁵ / ₈ "D x 20"H, 2 Doors | H105WMH48PC | 117 | 12.6 | \$1103 | \$25 | \$30 |

NOTES:

- Wall attachment methodology: horizontally mounted, interlocking brackets.
- Wall mounted storage cabinet door design overlaps end panels so that when multiple units are placed side-by-side they appear as one continuous unit.
- Laminate doors are non-locking.
- Horizontal interlocking rails are included; due to varying types of walls, installers are responsible for selecting and supplying the appropriate fasteners. Tackboard widths differ slightly from wall mounted storage cabinet widths. For applications where multiple wall mounted storage cabinets are placed side-by-side, the preferred tackboard solution may be to utilize a larger tackboard size.
- ! Wall mounted storage cabinet attachment requires individual cabinets be secured by a minimum of two wall mounting locations/studs.
- ! Wall mounted storage cabinets are designed for interior and perimeter walls that are constructed with wood or metal studs.
- ! The HON Company is not responsible for any liabilities resulting from wall mounted storage cabinets that are not properly installed.

HOW TO SPECIFY

| | | |
|---|---|--|
| <p>Select Model Number</p> <p>H 1 0 5 W M H 4 8</p> | <p>Select Laminate Top and Chassis Color</p> <p>See page 266</p> <p>N N</p> | <p>Select Door Front Laminate</p> <p>See page 266</p> <p>N</p> |
|---|---|--|

10500 SERIES™

Shared Components & Accessories

OPEN MARKET

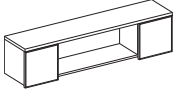
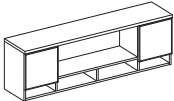

Icon Legend on page 19

| | DESCRIPTION | MODEL | SHIP | | LIST PRICE BY LAMINATE GRADE | |
|--|--|---------------------|--------|------|------------------------------|---------------|
| | | | WEIGHT | CUBE | L1 | L2 |
|  | Wall Mounted Open Hutch, Glass Doors | | | | | |
| | 72"W x 14 ⁵ / ₈ "D x 15"H, 2 Doors | H105WMH72PG | 162 | 17.5 | \$2014 | \$2049 |
| | 66"W x 14 ⁵ / ₈ "D x 15"H, 2 Doors | H105WMH66PG | 115 | 16.1 | \$1889 | \$1919 |
| | 60"W x 14 ⁵ / ₈ "D x 15"H, 2 Doors | H105WMH60PG | 108 | 14.7 | \$1761 | \$1791 |
| | 48"W x 14 ⁵ / ₈ "D x 15"H, 2 Doors | H105WMH48PG | 93 | 12.6 | \$1633 | \$1663 |
|  | Wall Mounted Open Hutch with Cubby, Glass Doors | | | | | |
| | 72"W x 14 ⁵ / ₈ "D x 20"H, 2 Doors | H105WMH72PCG | 166 | 21.3 | \$2014 | \$2049 |
| | 66"W x 14 ⁵ / ₈ "D x 20"H, 2 Doors | H105WMH66PCG | 155 | 19.6 | \$1889 | \$1919 |
| | 60"W x 14 ⁵ / ₈ "D x 20"H, 2 Doors | H105WMH60PCG | 144 | 17.9 | \$1761 | \$1791 |
| | 48"W x 14 ⁵ / ₈ "D x 20"H, 2 Doors | H105WMH48PCG | 121 | 15.2 | \$1633 | \$1663 |

NOTES:

- Wall attachment methodology: horizontally mounted, interlocking brackets.
 - Wall mounted storage cabinet door design overlaps end panels so that when multiple units are placed side-by-side they appear as one continuous unit.
 - Rich woodgrain laminate and frosted doors with silver frames adds a contemporary mixed materials option to the 10500 Series™.
 - Horizontal interlocking rails are included; due to varying types of walls, installers are responsible for selecting and supplying the appropriate fasteners. Tackboard widths differ slightly from wall mounted storage cabinet widths. For applications where multiple wall mounted storage cabinets are placed side-by-side, the preferred tackboard solution may be to utilize a larger tackboard size.
- ⚠ Wall mounted storage cabinet attachment requires individual cabinets be secured by a minimum of two wall mounting locations/studs.
 - ⚠ Wall mounted storage cabinets are designed for interior and perimeter walls that are constructed with wood or metal studs.
 - ⚠ The HON Company is not responsible for any liabilities resulting from wall mounted storage cabinets that are not properly installed.

HOW TO SPECIFY

Select
Model Number

H 1 0 5 W M H 6 6 P G .

Select
Laminate Top and Chassis Color

See page 266

N N



Icon Legend on page 19

10500 SERIES™ Storage

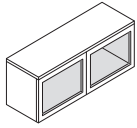

| DESCRIPTION | MODEL | SHIP WEIGHT | CUBE | LIST PRICE BY LAMINATE GRADE | |
|--|-----------------|-------------|------|------------------------------|---------------|
| | | | | L1 | L2 |
| Wall Mounted Storage Cabinet, Frosted Doors with Silver Frame | | | | | |
| 48"W x 14 5/8"D x 17 1/2"H | H105383G | 114.0 | 13.9 | \$1451 | \$1476 |
| 42"W x 14 5/8"D x 17 1/2"H | H105382G | 97.0 | 12.3 | \$1224 | \$1249 |
| 36"W x 14 5/8"D x 17 1/2"H | H105381G | 87.0 | 10.7 | \$1144 | \$1169 |
| 30"W x 14 5/8"D x 17 1/2"H | H105380G | 73.0 | 9.1 | \$1089 | \$1114 |

NOTES: Door design overlaps end panels so that when multiple units are placed side-by-side they appear as one continuous unit. Product placement can be aligned to match the height of storage cabinets, wardrobes and towers. Equipped with self-closing, adjustable side-hinged doors. The 30", 36", and 42"W units have two doors; the 48"W has three doors. Frosted door units do not have a lock option. Wall attachment methodology: horizontally mounted, interlocking brackets.

Tackboard widths differ slightly from wall mounted storage cabinet widths. For applications where multiple wall mounted storage cabinets are placed side-by-side, the preferred tackboard width may be to utilize a larger tackboard size.

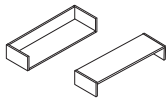

Not available in two-tone laminate



| DESCRIPTION | MODEL | SHIP WEIGHT | CUBE | LIST PRICE BY LAMINATE GRADE | |
|--------------------------------|----------------|-------------|------|------------------------------|--------------|
| | | | | L1 | L2 |
| Wall Mounted Open Shelf | | | | | |
| 48"W x 9 7/8"D x 4 3/4"H | H105363 | 18.0 | 1.2 | \$328 | \$348 |
| 42"W x 9 7/8"D x 4 3/4"H | H105362 | 16.0 | 0.8 | \$297 | \$317 |
| 36"W x 9 7/8"D x 4 3/4"H | H105361 | 14.0 | 0.8 | \$270 | \$285 |
| 30"W x 9 7/8"D x 4 3/4"H | H105360 | 12.0 | 0.8 | \$256 | \$271 |

NOTES: Ideal for books, photographs, and mementos up to 9"D. Two attachment orientation options, open ended shelf or shelf with book ends. Available in woodgrain or solid color laminates only. No patterns. No two-tone combinations. Simple assembly.

SPECIFYING EXAMPLE: H105363.N

NOTES:

- Easy-care, scratch-, spill- and stain-resistant laminate over solid core high-performance particleboard.
- Stacked paper management (model HLVPM2), which is 32 1/2"W, is compatible with the 30"W and 36"W wall mounted storage cabinets.
- ! Wall mounted storage cabinet attachment requires individual cabinets be secured by a minimum of two wall mounting locations/studs.
- ! Wall mounted storage cabinets are designed for interior and perimeter walls that are constructed with wood or metal studs.
- ! The HON Company is not responsible for any liabilities resulting from wall mounted storage cabinets that are not properly installed.



OPEN MARKET

| DESCRIPTION | MODEL | SHIP WEIGHT | CUBE | LIST PRICE |
|---|--------------------|-------------|------|--------------|
| LED Task Lights | | | | |
| 31" LED Light with Power Supply (Single) | HLED31AS ☺ | 1.5 ☺ | 0.09 | \$603 |
| 17" LED Light with Power Supply (Single) | HLED17AS ☺ | 1.2 ☺ | 0.05 | \$450 |
| 31" LED Light with Power Supply for Daisy-chain (Starter) | HLED31A | 1.4 ☺ | 0.09 | \$662 |
| 17" LED Light with Power Supply for Daisy-chain (Starter) | HLED17A | 1.0 ☺ | 0.05 | \$493 |
| 31" LED Light with 8" Jumper Cord for Daisy-chain (Follower) | HLED31AUO ☺ | 1.0 ☺ | 0.05 | \$539 |
| 17" LED Light with 8" Jumper Cord for Daisy-chain (Follower) | HLED17AUO ☺ | 1.0 ☺ | 0.03 | \$404 |
| Undercabinet Occupancy Sensor with 1" End to End Connector | HLEDOSA ☺ | 0.2 ☺ | 0.01 | \$97 |

NOTES: To use the daisy chain application, must start with model HLED17A or HLED31A. No finish specification required. Attaches magnetically to underside of overhead storage, or attaches with provided screws or double-sided tape. Occupancy sensor attaches to a single or starter LED light and will automatically turn the light off after no motion is detected for 30 minutes. Just like all the LED light models, the occupancy sensor features a soft-touch on/off switch. LED task lights have a lifetime of 50,000 hours and have a dimmer feature that allows the user to adjust the amount of light output.

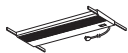

Refer to the Workplace Tools section in the 2021 Shared Spaces Pricer

OPEN MARKET

| | | | | |
|---|-----------------|--------|-----|--------------|
| Recessed Task Light , 46 1/2"W x 3 1/8"D, for Models H105327, H10534, H10533 and H105324 | HH870960 | 12.0 ☺ | 1.1 | \$290 |
| Recessed Task Light , 34 5/8"W x 3 1/8"D, for Models H105323, H105322, H105382 and H105383 | HH870942 | 10.0 ☺ | 0.9 | \$267 |
| Recessed Task Light , 22 7/8"W x 3 1/8"D, for Models H105321, H105380 and H105381 | HH870930 | 7.0 ☺ | 0.6 | \$247 |

NOTES: For additional information see the Workplace Tools section in the 2021 Shared Spaces Pricer.

HOW TO SPECIFY

| | |
|---|--|
| <p>Select Model Number</p> <p>H 1 0 5 3 8 3 G .</p> | <p>Select Laminate Top and Chassis Color</p> <p>See pages 266-267</p> <p>H H</p> |
|---|--|

10500 SERIES™ Shared Components & Accessories

GSA SIN 33721



Icon Legend on page 19

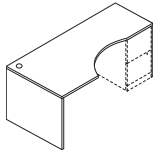

Right-hand model
H105815R shown



DESCRIPTION

Extended Corner Unit

24"W x 36"D x 72"W x 24"D x 29½"H, Right (shown)
24"D x 72"W x 36"D x 24"W x 29½"H, Left

MODEL

H105815R
H105816L

SHIP WEIGHT **CUBE**

184 7.0
184 7.0

LIST PRICE BY LAMINATE GRADE
L1 **L2**

\$1139 **\$1184**
\$1139 **\$1184**

NOTES: Intended for use with returns or bridges. Can be used freestanding. The 17" user side dimension is designed to accommodate 10500 Series™ modular or mobile pedestals up to 15¾"W. One grommet in top and one cord pass-through grommet in modesty panel. See pages 301-305 for optional stack-ons and tackboards. Extended corner units (H105815R and H105816L) can be used with 36"W return shell (H105680) to achieve a 6' x 6' layout.

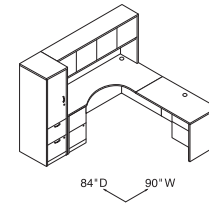
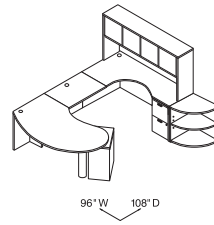
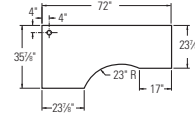

H105204L
H105102
H105598
H105815R
H105104
H10534
H105520

H105298L
H105816L
H10504
H10534
H10515R

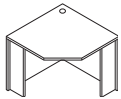

Corner Unit

24" x 36" x 36" x 24" x 29½"H

H105811

130 3.1

\$820 **\$855**

NOTES: Intended for use with 24"D x 29½"H returns or bridges. Can be used freestanding. 36" corner unit (H105811) can be used with two 36"W return shells (H105680) to achieve a 6' x 6' layout.

⚠ Not designed to attach to returns or bridges manufactured prior to 5/24/99.

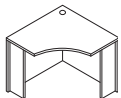
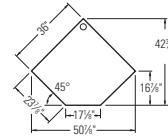

Curved Corner Unit

18" x 36" x 36" x 18" x 29½"H

H105810

128 5.4

\$820 **\$855**

NOTES: Can be used freestanding.

⚠ Designed to be used with curved returns only.

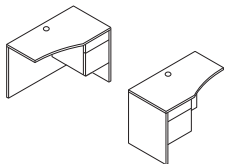

Curved Return — box/file

42"W x 18-24"D x 29½"H, Right
42"W x 24-18"D x 29½"H, Left

H105817R
H105818L

134 20.5
134 20.5

\$888 **\$928**
\$888 **\$928**

NOTES: Pedestal locks. One cord grommet in top; one pass-through grommet in top center of modesty panel. H105327 stack-on storage (78"W) can be used to span corner unit and return. H105322 stack-on storage (42"W) can be used on return. See page 302.

⚠ Designed to be used with curved corner unit only.

⚠ Not designed to be used freestanding.

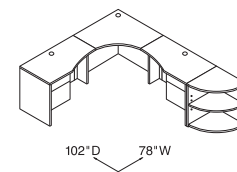
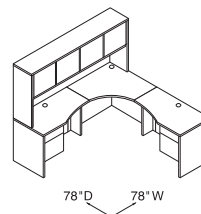

H105818L
H105810
H105327
H105817R

H105818
H105810
H105817R
H105520

NOTES:

- Shared components shown on this page can be used with modular components shown on pages 274-291, full pedestal models shown on pages 292-293, and 3/4 pedestal models shown on pages 296-297.
- Mobile pedestals, shown on page 311, work well in a variety of configurations.
- End cap bookshelf units are ideal for books and personal items — see page 316.
- For work-in-process paper management tools, see pages 319-320.
- For 10500 Series™ matching occasional tables, use the H80191, H80192, and H80193 on page 321.
- For conference table options, see the Preside® table tops and bases in the Tables section in the 2021 Shared Spaces Pricer.
- See pages 298-325 for shared components.

HOW TO SPECIFY

| | |
|----------------------------|--|
| Select Model Number | Select Laminate Top and Chassis Color |
| | See pages 266-267 |
| H 1 0 5 8 1 5 R . | N N |



10500 SERIES™

Shared Components & Accessories

| | DESCRIPTION | MODEL | SHIP WEIGHT | CUBE | LIST PRICE BY LAMINATE GRADE | |
|--|--|---|------------------------------|--|--|--------------|
| | | | | | L1 | L2 |
| | Box/Box/File Mobile Pedestal (with core removable lock) 15 ³ / ₄ "W x 22 ³ / ₄ "D x 28 ³ / ₈ "H — use freestanding or under 24"D, 30"D and 36"D modular shells NOTES: Top box drawer does not lock. File drawer includes hangrails. | H105102 | 121 | 8.5 | \$906 | \$946 |
| | File/File Mobile Pedestal (with core removable lock) 15 ³ / ₄ "W x 22 ³ / ₄ "D x 28 ³ / ₈ "H — use freestanding or under 24"D, 30"D and 36"D modular shells NOTES: File drawers include hangrails. | H105104 | 121 | 8.4 | \$906 | \$946 |
| | Box/File Mobile Pedestal (with core removable lock) 15 ³ / ₄ "W x 18 ⁷ / ₈ "D x 21 ⁷ / ₈ "H — use freestanding or under 20"D, 24"D, 30"D and 36"D modular shells | H105106 | 65 | 5.8 | \$757 | \$787 |
| | Shelf/Box/File Mobile Pedestal (with core removable lock) 15 ³ / ₄ "W x 18 ⁷ / ₈ "D x 28 ³ / ₈ "H — use freestanding or under 20"D, 24"D, 30"D and 36"D modular shells NOTES: Interior dimensions of the open storage area of the Shelf/Box/File model are 14 ¹ / ₈ "W x 16 ³ / ₄ "D x 6 ⁵ / ₈ "H. | H105109 | 73 | 7.3 | \$834 | \$874 |
| | Lateral File (with core removable lock) 36"W x 20"D x 59 ¹ / ₈ "H — four drawer 36"W x 20"D x 45 ¹ / ₂ "H — three drawer 36"W x 24"D x 29 ¹ / ₂ "H — two drawer 36"W x 20"D x 29 ¹ / ₂ "H — two drawer NOTES: Includes hangrails, mechanical interlock and in H10563 and H105690, a counterweight. Stack-on storage (H105321) and bookcase hutch (H105292) can be used with H10563 and H105690. Interlock inhibits the extension of more than one drawer from opening at a time. Model H105690 aligns with 24"D credenzas and returns. | H10516 ☉ 305 H10517 240 H105690 191 H10563 ☉ 170 | 31.0 23.2 17.6 15.6 | \$2232 \$1694 \$1085 \$1032 | \$2302 \$1759 \$1140 \$1082 | |

NOTES:

- For additional components that can be shared with 10500 Series™, see pages 298-325.
- Mobile pedestals feature clean styling with hidden casters. Versatile designs roll easily and work well in a variety of configurations. Can be used freestanding, under modular shells, or with 10500 Series™ component worksurfaces and supports.
- 24"D lateral file, storage cabinet, and bookcase models align evenly with credenzas and returns to provide linear layout continuity.
- At 45¹/₂"H, the three-drawer lateral file can be used as a standing-height worksurface or to support office equipment.
- Drawers operate on full extension, ball-bearing suspensions to ensure smooth, quiet, long-lasting operation.
- File drawer design includes integrated hangrails for side-to-side letter or legal filing; and front-to-back for letter filing.
- Mobile printer/fax cart shown on page 291 is ideal for limited space.

HOW TO SPECIFY

| | |
|---|--|
| Select Model Number H 1 0 5 1 0 2 | Select Laminate Top and Chassis Color See pages 266-267 N N |
|---|--|



10500 SERIES™

Shared Components & Accessories

GSA SIN 33721 EXCEPT AS NOTED

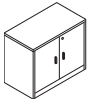
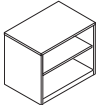
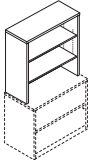

Icon Legend on page 19

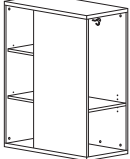
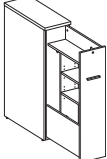
| | DESCRIPTION | MODEL | SHIP WEIGHT | CUBE | LIST PRICE BY LAMINATE GRADE | |
|--|---|----------------------------------|-------------|--------------|------------------------------|-------------------------------|
| | | | | | L1 | L2 |
|  | Storage Cabinet with Doors (with core removable lock) | | | | | |
| | 36"W x 24"D x 29½"H 36"W x 20"D x 29½"H | H105290 H105291 | 168 147 | 17.6 15.0 | \$983 \$828 | \$1038 \$878 |
| | NOTES: Includes one adjustable shelf. Shelf adjusts in ¼" increments with a total range of 5"H. Stack-on storage (H105321), and bookcase hutch (H105292) can be used with H105291 or H105290. Model H105290 aligns with 24"D credenzas and returns. | | | | | |
|  | Bookcase | | | | | |
| | 36"W x 24"D x 29½"H, 2-Shelf, 1-Adjustable | H105531 | 102 | 18.4 | \$803 | \$818 |
| | NOTES: Adjustable shelf is 22"D and adjusts in ¼" increments, with a total range of 5". 24" depth aligns evenly with 24"D credenzas, credenza shells, returns, return shells, and wardrobe/storage cabinets to provide linear layout continuity. Adjustable leveling glides. Accommodates the 36"W stack-on storage or bookcase hutch. Ships fully assembled. | | | | | |
|  | Bookcase Hutch (for use with lateral file models H10563/H105690, storage cabinet models H105291/H105290, and bookcase model H105531) | | | | | |
| | 36"W x 14⅝"D x 37⅞"H | H105292 | 103 | 3.6 | \$605 | \$620 |
| | NOTES: Cord pass-through gap behind shelves and a 1⅝"H full-width cord management slot at the bottom of the back panel. Two shelves are adjustable in ¼" increments with a total range of 17½"H. | | | | | |
|   | Multi-Use Stack-On Storage | | | | | |
|  | 36"W x 18"D x 45⅝"H | H105310 | 142 | 21.9 | \$1123 | \$1158 |
| | NOTES: Non-handed. Design features user's side bookcase and end access mixed storage compartment. Three fixed bookcase compartments, each 12"W x 13¾"H. Versatile mixed storage area includes two coat hooks and two shelves; one adjustable in ¼"H increments with a total range of 5" (shelf count includes bottom of the unit). For use on worksurfaces 36" or wider and 18" or deeper. Total height, in combination with low credenza, is 66⅝". Accepts markerboard models HLSL1536SOMB or HLSL1530SOMB (sold separately). Ships fully assembled. | | | | | |
| | Slide Out Tower | | | | | |
|  | 12"W x 30"D x 50"H, Right | H105ST123050R | 215 | 13.8 | \$3180 | \$60 \$20 |
| | 12"W x 30"D x 50"H, Left | H105ST123050L | 215 | 13.8 | \$3180 | \$60 \$20 |
| | 12"W x 24"D x 50"H, Right | H105ST122450R | 182 | 11.4 | \$2868 | \$50 \$20 |
| | 12"W x 24"D x 50"H, Left | H105ST122450L | 182 | 11.4 | \$2868 | \$50 \$20 |
| | NOTES: Wardrobe space contains one coat hook. Storage space includes three shelves; two are adjustable in 2½" increments. Door access left or right models available. Equipped with HON "One Key" interchangeable core removable locks. Standard with Black linear pull. | | | | | |

OPEN MARKET**NOTES:**

- For additional components that can be shared with 10500 Series™, see pages 298-325.
- Versatile mobile pedestals roll easily and work well in a variety of configurations. Can be used freestanding, under modular shells, or with 10500 Series™ component worksurfaces and supports.
- 24"D lateral file, storage cabinet, and bookcase models align evenly with credenzas and returns to provide linear layout continuity.
- Mobile printer/fax cart shown on page 291 is ideal for limited space.

HOW TO SPECIFY

| | | | | |
|---|--|--|--|---|
| Select Model Number H 1 0 5 2 9 1 . | Select Laminate Top and Chassis Color See pages 266-267 N N | | | |
| Select Model Number H 1 0 5 S T 1 2 3 0 5 0 R . | Select Laminate Top and Chassis Color See page 266 N N . | Select Door Front Laminate See page 266 N . | Select Pull and Color L Linear P Black L P . | Select Lock Option Not available on Open Credenzas L Lock L |



Icon Legend on page 19

10500 SERIES™ Shared Components & Accessories

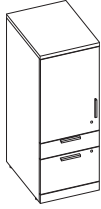

DESCRIPTION

Storage Wardrobe

- 24"W x 24"D x 50"H, Right
- 24"W x 24"D x 50"H, Left
- 24"W x 20"D x 50"H, Right
- 24"W x 20"D x 50"H, Left
- 18"W x 24"D x 50"H, Right
- 18"W x 24"D x 50"H, Left
- 18"W x 20"D x 50"H, Right
- 18"W x 20"D x 50"H, Left

MODEL

- H105LT242450CBFR**
- H105LT242450CBFL**
- H105LT242050CBFR**
- H105LT242050CBFL**
- H105LT182450CBFR**
- H105LT182450CBFL**
- H105LT182050CBFR**
- H105LT182050CBFL**

SHIP WEIGHT

- 202
- 202
- 178
- 178
- 168
- 168
- 147
- 147

CUBE

- 21.3
- 21.3
- 17.9
- 17.9
- 16.2
- 16.2
- 13.7
- 13.7

L1 LIST

- \$2173**
- \$2173**
- \$2120**
- \$2120**
- \$2067**
- \$2067**
- \$1832**
- \$1832**

L2 UPCHARGES
CHASSIS FRONTS

- \$60 \$35**
- \$60 \$35**
- \$50 \$35**
- \$50 \$35**
- \$50 \$30**
- \$50 \$30**
- \$45 \$30**
- \$45 \$30**

NOTES: Spacious design includes a wardrobe closet, storage cabinet, one box drawer, and one file drawer in one compact unit. Wardrobe closet contains a coat rod. Storage cabinet includes two shelves, one is adjustable in 2½" increments. Door hinged left or right models available. Box and file drawers operate on ball-bearing suspensions with full extension. File drawers have high sides to accept hanging folders in letter or legal size. Drawers standard with hangrails. Equipped with HON "One Key" interchangeable core removable locks. Upper lock secures storage cabinet and wardrobe closet doors; lower lock secures file drawers.

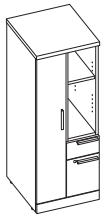

Open Wardrobe

- 24"W x 24"D x 50"H, Right
- 24"W x 24"D x 50"H, Left
- 24"W x 20"D x 50"H, Right
- 24"W x 20"D x 50"H, Left
- 18"W x 24"D x 50"H, Right
- 18"W x 24"D x 50"H, Left
- 18"W x 20"D x 50"H, Right
- 18"W x 20"D x 50"H, Left

- H105LT242450BFR**
- H105LT242450BFL**
- H105LT242050BFR**
- H105LT242050BFL**
- H105LT182450BFR**
- H105LT182450BFL**
- H105LT182050BFR**
- H105LT182050BFL**

- 190
- 190
- 167
- 167
- 161
- 161
- 141
- 141

- 21.3
- 21.3
- 17.9
- 17.9
- 16.2
- 16.2
- 13.7
- 13.7

- \$2120**
- \$2120**
- \$1908**
- \$1908**
- \$2014**
- \$2014**
- \$1779**
- \$1779**

- \$60 \$35**
- \$60 \$35**
- \$50 \$35**
- \$50 \$35**
- \$50 \$30**
- \$50 \$30**
- \$45 \$30**
- \$45 \$30**

NOTES: Spacious design includes a wardrobe closet, open storage, one box drawer, and one file drawer in one compact unit. Wardrobe closet contains a coat rod. Storage cabinet includes two shelves, one is adjustable in 2½" increments. Door hinged left or right models available. Box and file drawers operate on ball-bearing suspensions with full extension. File drawers have high sides to accept hanging folders in letter or legal size. Drawers standard with hangrails. Equipped with HON "One Key" interchangeable core removable locks. Lock secures box and file drawers; wardrobe is non-locking.



Side Access Wardrobe

- 24"W x 24"D x 50"H, Right
- 24"W x 24"D x 50"H, Left
- 24"W x 20"D x 50"H, Right
- 24"W x 20"D x 50"H, Left
- 18"W x 24"D x 50"H, Right
- 18"W x 24"D x 50"H, Left
- 18"W x 20"D x 50"H, Right
- 18"W x 20"D x 50"H, Left

- H105LT242450SBFR**
- H105LT242450SBFL**
- H105LT242050SBFR**
- H105LT242050SBFL**
- H105LT182450SBFR**
- H105LT182450SBFL**
- H105LT182050SBFR**
- H105LT182050SBFL**

- 187
- 187
- 166
- 166
- 153
- 153
- 135
- 135

- 21.3
- 21.3
- 17.9
- 17.9
- 16.2
- 16.2
- 13.7
- 13.7

- \$2203**
- \$2203**
- \$2014**
- \$2014**
- \$2084**
- \$2084**
- \$1832**
- \$1832**

- \$60 \$35**
- \$60 \$35**
- \$50 \$35**
- \$50 \$35**
- \$50 \$30**
- \$50 \$30**
- \$45 \$30**
- \$45 \$30**

NOTES: Spacious design includes a wardrobe closet, open side access storage, one box drawer, and one file drawer in one compact unit. Wardrobe closet contains a coat rod. Storage cabinet includes two shelves, one is adjustable in 2½" increments. Door hinged left or right models available. Box and file drawers operate on ball-bearing suspensions with full extension. File drawers have high sides to accept hanging folders in letter or legal size. Drawers standard with hangrails. Equipped with HON "One Key" interchangeable core removable locks. Lock secures box and file drawers; wardrobe is non-locking.

NOTES:

- Broad family of storage components beyond the confines of a desk drawer.
- Locking units equipped with interchangeable core removable locks.
- Adjustable hex leveling glides allow floor-standing furniture to be easily leveled without lifting the unit; glides have ¾" adjustable range.

HOW TO SPECIFY

| | | | | |
|--|--|---|--|---|
| <p>Select Model Number</p> <p>H 1 0 5 L T 1 8 2 4 5 0 B F R .</p> | <p>Select Laminate Top and Chassis Color</p> <p>See page 266 Kickplates will match chassis color</p> <p>N N .</p> | <p>Select Door Front Laminate</p> <p>See page 266</p> <p>N .</p> | <p>Select Pull and Color</p> <p>L Linear P Black</p> <p>L P .</p> | <p>Select Lock Option</p> <p>L Lock</p> <p>L</p> |
|--|--|---|--|---|

10500 SERIES™

Shared Components & Accessories

OPEN MARKET



Icon Legend on page 19

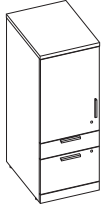

| DESCRIPTION | MODEL | SHIP WEIGHT | CUBE | L1 LIST | L2 UPCHARGES | |
|---|--------------------------|-------------|------|---------------|--------------|-------------|
| | | | | | CHASSIS | FRONTS |
| Storage Cabinet 18"W x 24"D x 50"H, Right | H105LT182450SCBFR | 158 | 16.2 | \$1670 | \$50 | \$30 |
| 18"W x 24"D x 50"H, Left | H105LT182450SCBFL | 158 | 16.2 | \$1670 | \$50 | \$30 |

NOTES:

- Versatile unit features a storage cabinet, one box drawer, and one file drawer.
- Storage cabinet includes two shelves, one is adjustable in 2½" increments.
- Door hinged left or right models available.
- File drawers operate on ball-bearing suspensions with full extension.
- File drawers have high sides to accept hanging folders in letter or legal size.
- Drawers standard with hangrails.
- Both the storage cabinet and the file drawers are equipped with a HON "One Key" interchangeable core removable lock.
- Upper lock secures storage cabinet; lower lock secures box and file drawers.
- Broad family of storage components beyond the confines of a desk drawer.
- Locking units equipped with interchangeable core removable locks.
- Adjustable hex leveling glides allow floor-standing furniture to be easily leveled without lifting the unit; glides have ¾" adjustable range.



HOW TO SPECIFY

| | | | | |
|--|---|---|---|--|
| Select Model Number H 1 0 5 L T 1 8 2 4 5 0 S C B F R . | Select Laminate Top and Chassis Color See page 266 Kickplates will match chassis color N N . | Select Door Front Laminate See page 266 N . | Select Pull and Color L Linear P Black L P . | Select Lock Option L Lock L |
|--|---|---|---|--|

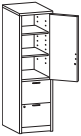

10500 SERIES™

Shared Components & Accessories

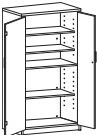
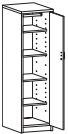
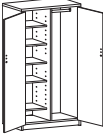
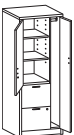
| | DESCRIPTION | MODEL | SHIP WEIGHT | CUBE | LIST PRICE BY LAMINATE GRADE | |
|--|--|-----------------|-------------|------|------------------------------|---------------|
| | | | | | L1 | L2 |
|  Right-hand model H105297R shown | Storage/File Cabinet (with core removable locks) | | | | | |
| | 18"W x 24"D x 66 $\frac{5}{8}$ "H, Hinged Right (shown) | H105297R | 258 | 22.7 | \$1794 | \$1869 |
| | 18"W x 24"D x 66 $\frac{5}{8}$ "H, Hinged Left | H105298L | 258 | 22.7 | \$1794 | \$1869 |
| | NOTES: Versatile unit features a storage cabinet and two file drawers. Storage cabinet includes three shelves, two are adjustable in 2 $\frac{1}{2}$ " increments. Door hinged left or right models available. File drawers operate on ball-bearing suspensions with full extension. File drawers have high sides to accept hanging folders in letter or legal size. Drawers standard with hangrails. Both the storage cabinet and the file drawers are equipped with a HON "One Key" interchangeable core removable lock. Unit height is designed to match credenza or return plus stack-on storage height. | | | | | |
|  Doors open 110 degrees from closed position. | Storage Cabinet/Lateral File (with core removable lock) | | | | | |
| | 36"W x 24"D x 66 $\frac{5}{8}$ "H | H105293 | 365 | 41.0 | \$2415 | \$2515 |
| | NOTES: Storage cabinet is standard with one fixed and two full-width adjustable shelves in top compartment; adjustable shelves can be removed. Overall storage compartment measures 31 $\frac{1}{4}$ "W x 22"D x 36 $\frac{1}{8}$ "H and will accommodate supplies, books and binders, as well as business machines and electronic equipment. Cord pass-through gap behind shelves and grommet in back of the cabinet to facilitate routing cords and reaching wall electrical outlets. Two drawer lateral file on bottom. Lateral file comes with mechanical interlock and hangrails. Cabinet and lateral file lock independently. Unit height is designed to match credenza or return plus stack-on storage height. | | | | | |
|  Doors open 110 degrees from closed position. | Storage Cabinet with Full-width Shelves (with core removable lock) | | | | | |
| | 36"W x 24"D x 66 $\frac{5}{8}$ "H | H105299 | 341 | 39.6 | \$2254 | \$2354 |
| | NOTES: Large storage area includes five, full-width (side-to-side) shelves; three are adjustable in 2 $\frac{1}{2}$ " increments. Unit height matches credenza or return plus stack-on storage height. | | | | | |
|  Right-hand model H105295R shown | Personal Wardrobe/Storage Cabinet (with core removable lock) | | | | | |
| | 18"W x 24"D x 66 $\frac{5}{8}$ "H, Hinged Right (shown) | H105295R | 223 | 22.9 | \$1625 | \$1700 |
| | 18"W x 24"D x 66 $\frac{5}{8}$ "H, Hinged Left | H105296L | 223 | 22.9 | \$1625 | \$1700 |
| | NOTES: Unit is standard with four adjustable shelves, coat rod, and core removable lock. Shelves adjust in 2 $\frac{1}{2}$ " increments. Cabinet can be used as a wardrobe by removing four adjustable shelves. Coat rod can be removed from cabinet for storage only applications. Unit height is designed to match credenza or return plus stack-on storage height. | | | | | |
|  Doors open 110 degrees from closed position. | Personal Wardrobe/Storage Cabinet (with core removable lock) | | | | | |
| | 36"W x 24"D x 66 $\frac{5}{8}$ "H | H10530 | 341 | 41.0 | \$2415 | \$2427 |
| | NOTES: Spacious design is standard with four adjustable shelves (one shelf is fixed), coat rod and core removable lock which locks both doors. Shelves adjust in 2 $\frac{1}{2}$ " increments. Unit height is designed to match credenza or return plus stack-on storage height. | | | | | |
|  Right-hand model H105301R shown | Personal Storage Tower (with core removable locks) | | | | | |
| | 24"W x 24"D x 66 $\frac{5}{8}$ "H, wardrobe Hinged Right, storage cabinet Hinged Left (shown) | H105301R | 299 | 27.9 | \$2268 | \$2363 |
| | 24"W x 24"D x 66 $\frac{5}{8}$ "H, wardrobe Hinged Left, storage cabinet Hinged Right | H105302L | 299 | 27.9 | \$2268 | \$2363 |
| | NOTES: Spacious design includes a wardrobe closet, storage cabinet, and two file drawers in one compact unit. Wardrobe closet contains a coat rod. Storage cabinet includes three shelves, two are adjustable in 2 $\frac{1}{2}$ " increments. Door hinged left or right models available. File drawers operate on ball-bearing suspensions with full extension. File drawers have high sides to accept hanging folders in letter or legal size. Drawers standard with hangrails. Equipped with HON "One Key" interchangeable core removable locks. Upper lock secures storage cabinet and wardrobe closet doors; lower lock secures file drawers. Unit height is designed to match credenza or return plus stack-on storage height. | | | | | |

NOTES:

- Broad family of storage components takes organization way beyond the confines of a desk drawer.
- Locking units equipped with interchangeable core removable locks.
- Adjustable hex leveling glides allow floor-standing furniture to be easily leveled without lifting the unit; glides have $\frac{3}{4}$ " adjustable range.
- See pages 298-325 for shared components.

🔑 Keyed alike cores must be ordered separately — see model HF23B on page 773 — makes re-keying quick and easy.

HOW TO SPECIFY

| | |
|----------------------------|--|
| Select Model Number | Select Laminate Top and Chassis Color |
| See pages 266-267 | See pages 266-267 |
| H 1 0 5 2 9 7 R . | N N |

10500 SERIES™

Shared Components & Accessories

GSA SIN 33721



Icon Legend on page 19



H105532 shown



| DESCRIPTION | MODEL | SHIP WEIGHT | CUBE | LIST PRICE BY LAMINATE GRADE | |
|---|----------------|-------------|------|------------------------------|--------------|
| | | | | L1 | L2 |
| Bookcase | | | | | |
| 5 Shelf, 36"W x 13 ¹ / ₈ "D x 71"H | H105535 | 187 | 25.1 | \$875 | \$905 |
| 4 Shelf, 36"W x 13 ¹ / ₈ "D x 57 ¹ / ₈ "H | H105534 | 156 | 20.2 | \$753 | \$778 |
| 3 Shelf, 36"W x 13 ¹ / ₈ "D x 43 ³ / ₈ "H | H105533 | 122 | 15.6 | \$639 | \$659 |
| 2 Shelf, 36"W x 13 ¹ / ₈ "D x 29 ⁵ / ₈ "H | H105532 | 90 | 11.0 | \$503 | \$518 |

NOTES: Fixed shelves. Inside shelf dimensions on all units is 33³/₄"W x 12"D x 13"H. No assembly required.

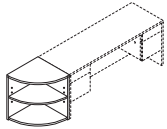

| | | | | | |
|---|----------------|----|-----|--------------|--------------|
| End Cap Bookshelf (2 shelves, 1 fixed, 1 adjustable. Adjusts in 2¹/₂" increments with a total range of 10"H) | | | | | |
| 24"W x 24"D x 29 ¹ / ₂ "H | H105520 | 84 | 2.6 | \$640 | \$655 |

NOTES: Unit is freestanding. Designed to be positioned at the end of 24"D credenzas and returns. Ideal for books, photos, plants and mementos.

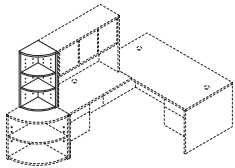

| | | | | | |
|---|----------------|----|-----|--------------|--------------|
| End Cap Bookshelf (3 shelves, 1 fixed, 2 adjustable. Adjusts in 2¹/₂" increments with a total range of 25"H) | | | | | |
| 15"W x 15"D x 37 ¹ / ₈ "H | H105523 | 53 | 2.2 | \$551 | \$566 |

NOTES: Unit is designed to be positioned at the end of stack-on storage and on top of model H105520. Combined height of models H105520 and H105523 matches credenza or return plus stack-on storage height. Can be used freestanding.

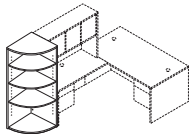

| | | | | | |
|---|----------------|-----|-----|---------------|---------------|
| End Cap Bookshelf | | | | | |
| 24"W x 24"D x 66 ⁵ / ₈ "H | H105524 | 164 | 4.8 | \$1066 | \$1091 |

NOTES: Designed to be positioned at the end of 24"D credenzas with stack-on storage, 24"D returns with stack-on storage, 24"D storage/file cabinet, 24"D storage cabinet/lateral file, 24"D wardrobe/storage cabinets, or the 24"D personal storage tower. Unit has four shelves, three are adjustable in 2¹/₂" increments, with a total range of 45"H; bottom shelf is fixed.



Model H105525R Model H105526L

| | | | | | |
|--|-----------------|----|-----|--------------|--------------|
| Square End Cap Bookshelf — 2-Fixed Shelves | | | | | |
| 24"W x 24"D x 29 ¹ / ₂ "H, Right | H105525R | 92 | 3.6 | \$634 | \$649 |
| 24"W x 24"D x 29 ¹ / ₂ "H, Left | H105526L | 92 | 3.6 | \$634 | \$649 |

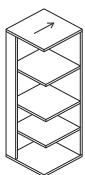
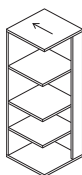

Model H105527R Model H105528L

| | | | | | |
|--|-----------------|-----|-----|---------------|---------------|
| Square End Cap Bookshelf — 4-Fixed Shelves | | | | | |
| 24"W x 24"D x 66 ⁵ / ₈ "H, Right | H105527R | 172 | 5.9 | \$1017 | \$1042 |
| 24"W x 24"D x 66 ⁵ / ₈ "H, Left | H105528L | 172 | 5.9 | \$1017 | \$1042 |

NOTES: Units are freestanding. Designed to be positioned next to 24"D models or as a corner bookcase.

End cap, left: grain direction on top aligns with grain direction on tops of left pedestal returns and left credenza models or when positioned to the left side of credenzas with doors or kneespace models.

End cap, right: grain direction on top aligns with grain direction on tops of right pedestal returns and right credenza models or when positioned to the right side of credenzas with doors or kneespace models.



NOTES:

- For 36"W x 24"D x 29¹/₂"H two-shelf bookcase, to align evenly with credenzas and returns, see page 312.

HOW TO SPECIFY

Select
Model Number

H 1 0 5 5 3 2 .

Select
Laminate Top and Chassis Color

See pages 266-267

N N

10500 SERIES™

Shared Components & Accessories

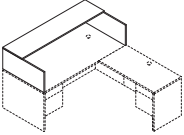
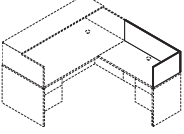
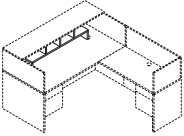
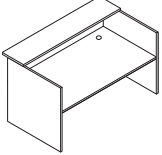
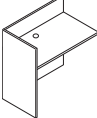
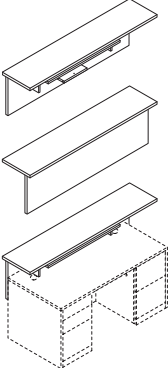
| | DESCRIPTION | MODEL | SHIP WEIGHT | CUBE | LIST PRICE BY LAMINATE GRADE | |
|---|---|----------------|-------------|------|------------------------------|---------------|
| | | | | | L1 | L2 |
|  | Reception Station with Transaction Counter, for 72"W x 36"D Desk, or Desk Shell, with rectangle top 72"W x 36"D x 14¼"H | H105720 | 92 | 3.0 | \$535 | \$570 |
| | NOTES: For desk tops without grommets, see field installable grommet kit, model HFLDGRMT on page 324. Transaction counter organizer (HTCOL52) fits under/inside of transaction counter (see below). | | | | | |
|  | Reception Station for 42"W x 24"D Return or Return Shell 42"W x 24"D x 13"H | H105722 | 2 | 1.0 | \$269 | \$289 |
| | Reception Station for 48"W x 24"D Return or Return Shell 48"W x 24"D x 13"H | H105721 | 25 | 3.6 | \$306 | \$326 |
| | NOTES: For return tops without grommets, see field installable grommet kit, model HFLDGRMT on page 324. Not available in two-tone laminate. Designed specifically for use with Reception Station with Transaction Counter, model H105720. | | | | | |
| | SPECIFYING EXAMPLE: H105722.N | | | | | |
| | DESCRIPTION | MODEL | SHIP WEIGHT | CUBE | LIST PRICE | |
|  | Transaction Counter Organizer 48¾"W x 11⅞"D x 13"H | HTCOL52 | 24 | 1.1 | \$300 | |
| | NOTES: Fits under reception station with transaction counter model H105720 reception desk shell (H105724), and work organizer models H10537 and H10536. | | | | | |
| | Black only. | | | | | |
| | SPECIFYING EXAMPLE: HTCOL52.P | | | | | |
| | DESCRIPTION | MODEL | SHIP WEIGHT | CUBE | LIST PRICE BY LAMINATE GRADE | |
|  | Reception Desk Shell, with rectangle top 72"W x 39⅞"D x 44⅞"H | H105724 | 294 | 17.0 | \$1142 | \$1197 |
| | NOTES: Non-handed design. Integrated 18⅝"D transaction counter with a 4" full-width overhang. Two cord management grommets in top for routing and hiding wires and cables. Transaction counter organizer model TCOL52 fits under/inside transaction counter. When a two-tone color combination is specified, the first designator defines the transaction countertop and the desk worksurface. | | | | | |
|  | Reception Station Return Shell 42"W x 24⅜"D x 42⅝"H | H105726 | 131 | 17.0 | \$795 | \$830 |
| | NOTES: Non-handed design for use with reception desk shell. One cord management grommet in top for routing and hiding wires and cables. Woodgrain on approach side is vertical to match grain direction on end panels of reception station desk. Designed specifically for use with Reception Desk Shell, model H105724. | | | | | |
|  | Transaction Counter for Reception Desk 66"W x 14⅝"D x 14¼"H | H105729 | 100 | 4.2 | \$664 | \$689 |
| | NOTES: Off-the-worksurface solution designed for use with 72"W or 66"W desks or desk shells with a 1⅞" thick rectangle top and a full-width conference (approach-side) overhang of 4½"D minimum. Choose from two height options at time of installation; 13⅞"H (upper position) or 5½"H (lower position) above the desktop. Attaches easily and securely without any drilling or double-sided tape on the worksurface. Grain direction: side-to-side on countertop; horizontal on approach and users side vertical panel. | | | | | |

NOTES:

- Three welcoming reception station designs to choose from — stack-on enclosure, full-to-floor shell, or front-suspended counter.
- For 10500 Series™ matching reception area furniture, see Occasional Tables on page 321.
- See pages 298-325 for shared components.

HOW TO SPECIFY

| | |
|----------------------------|--|
| Select Model Number | Select Laminate Top and Chassis Color |
| | See pages 266-267 |
| H 1 0 5 7 2 0 . | N N |

10500 SERIES™

Shared Components & Accessories

GSA SIN 33721



Icon Legend on page 19

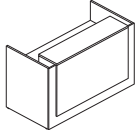

| DESCRIPTION | MODEL | SHIP WEIGHT | CUBE | L1 LIST | L2 UPCHARGES | | ACCENT PANEL |
|-------------|-------|-------------|------|---------|--------------|---------|--------------|
| | | | | | WORKSURFACE | CHASSIS | |

Reception Desk with Transaction Counter72"W x 36³/₄"D x 44"H**HLAM3772RD**

324

13.5

\$1563**\$35****\$70****\$25**

NOTES: Non-handed. Counter measures 60"W x 15¹/₄"D. Flat edge (G) matches 10500 Series™. For beaded (B) and tri-oval (V) edge shapes, the transaction counter is profiled on the approach and user sides, and the desk worksurface is profiled on the user's side. Beaded (B) and tri-oval (V) edges are available in L1 woodgrains colors only. Smooth and flat (G) edge available in all woodgrains and solid colors. Vertical grain on approach side and front accent panel for L1 laminates except Kingswood Walnut and Florence Walnut. Horizontal grain on L2 laminates and Kingswood and Florence Walnut. Vertical grain on end panels and horizontal grain on worksurface and transaction counter. Two worksurface cord management grommets for routing and hiding wires and cables; can be specified in Black (P) or Platinum (TI) finish.

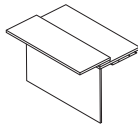
**Reception Return with 32'H Transaction Counter**48¹/₄"W x 32⁷/₈"D x 32"H**HLAM3348RR**

145

3.7

\$879**\$35****\$35****N/A**

NOTES: Non-handed. For use with HLAM3772RD and Reception Desk Shell (H105724). Counter facilitates accessibility; measures 48"W x 12"D x 32"H. Flat edge (G) matches 10500 Series™. For beaded (B) and tri-oval (V) edge shapes, the transaction counter is profiled on the approach side, and the return worksurface is profiled on the user's side. All other edges are flat banded. Beaded (B) and tri-oval (V) available in L1 woodgrain colors only. Flat edge (G) available in all woodgrains and solid colors. Pattern laminates do not have matching edge color; patterns can be specified with woodgrain or solid edge. Vertical grain on approach side, end panel, worksurface, and transaction counter. Assembly required. Cam covers used to allow for non-handed design.

Specify: Model.Edge Profile & EdgeColor.Worksurface & Counter Color.Chassis Color

SPECIFYING EXAMPLE: HLAM3348RR.GN.N.N**HOW TO SPECIFY**

| | | | | | |
|---|--|--|---|---|--|
| Select Model Number H L A M 3 7 7 2 R D . | Select Edge Profile and Edge Color See page 267 G N . | Select Grommet Color P Black TI Platinum Not specified for model HLAM3348RR P . | Select Worksurface Laminate See page 266 N . | Select Chassis Laminate See page 266 N . | Select Accent Panel Laminate See page 266 Not specified for model HLAM3348RR L D W 1 |
|---|--|--|---|---|--|

10500 SERIES™

Shared Components & Accessories

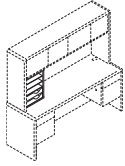

Not available in two-tone laminate



| DESCRIPTION | MODEL | SHIP WEIGHT | CUBE | LIST PRICE BY LAMINATE GRADE | |
|-------------|-------|-------------|------|------------------------------|----|
| | | | | L1 | L2 |

Vertical Paper Manager
14⁷/₈"W x 10⁷/₈"D x 19³/₈"H

| | | | | |
|---------------|----|-----|--------------|--------------|
| HLVPM1 | 27 | 2.8 | \$351 | \$361 |
|---------------|----|-----|--------------|--------------|

NOTES: Keeps papers, files, and books neatly organized and within easy reach from a seated position. Designed for desk, credenza, and return tops. Fits under stack-on storage models. Two pullout drawers and three fixed shelves. Unit can also be used with 10700 Series™, Valido®, and 94000 Series™. When used in conjunction with wall mounted storage cabinets, the top of the wall mounted storage cabinets must be positioned a minimum of 68" above the floor. For additional information see the Workplace Tools section in the 2021 Shared Spaces Pricer.

SPECIFYING EXAMPLE: HLVPM1.N

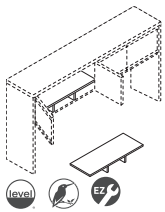

| DESCRIPTION | MODEL | SHIP WEIGHT | CUBE | LIST PRICE |
|-------------|-------|-------------|------|------------|
|-------------|-------|-------------|------|------------|

Stacked Paper Management
32¹/₂"W x 12⁵/₈"D x 4¹/₄"H

| | | | |
|---------------|----|------|--------------|
| HLVPM2 | 22 | 1.25 | \$175 |
|---------------|----|------|--------------|

NOTES: Segments and organizes stack-on and wall mount storage compartments, as well as bookcase shelves. In some cases, installation may require removing the stack-on or wall mount storage doors. For additional information see the Workplace Tools section in the 2021 Shared Spaces Pricer.

! Black only.

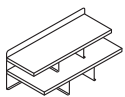

Not available in two-tone laminate



| DESCRIPTION | MODEL | SHIP WEIGHT | CUBE | LIST PRICE BY LAMINATE GRADE | |
|-------------|-------|-------------|------|------------------------------|----|
| | | | | L1 | L2 |

Desktop Storage Terrace
26¹/₂"W x 12¹/₂"D x 10¹/₂"H

| | | | | |
|---------------|----|-----|--------------|--------------|
| HLDST1 | 24 | 1.1 | \$329 | \$339 |
|---------------|----|-----|--------------|--------------|

NOTES: Keeps work-in-process, priority files, loose pages, and mail neatly organized and in view. Mixed material design comprised of sturdy laminate shelves with metal back and support panels. Not available in two-tone laminate combination or pattern laminate colors. Choose from Platinum Metallic (T1), Black (P), and Charcoal (S) for the metal components.

Sized to fit in stack-on and wall mounted storage cabinets in 10500, 10700, Valido, 94000, and 38000 Series. Fits in Voi stack-on and overhead cabinets except for 48"W or smaller sliding door models. For additional information see the Workplace Tools section in the 2021 Shared Spaces Pricer.

Specify: Model.Laminate.Paint

SPECIFYING EXAMPLE: HLDST1.N.T1



Refer to page 104 for Center Drawer compatibility information

| DESCRIPTION | MODEL | SHIP WEIGHT | CUBE | L1 | L2 |
|-------------|-------|-------------|------|------------|------------|
| | | | | LIST PRICE | LIST PRICE |

Angled Wood Center Drawer
26" x 15³/₈"
22" x 15³/₈"

| | | | | |
|--------------|------|-----|--------------|--------------|
| H1526 | 12 Ⓞ | 1.2 | \$214 | \$229 |
| H1522 | 11 Ⓞ | 1.1 | \$199 | \$214 |

NOTES: Specify laminate for drawer. Model H1522 can be used on peninsulas with modesty panel, model H10528. For additional information see the Workplace Tools section in the 2021 Shared Spaces Pricer.

NOTES:

- For 10500 Series™ matching Occasional Tables, see page 321.
- Vertical paper manager designed for desk, credenza, and return tops. Fits under stack-on storage.
- Stacked paper management segments and organizes stack-on and wall mount storage compartments, as well as bookcase shelves. Unit can be used in models H105327, H10534, H105322, H105321, H105382 and H105381.
- Desktop Storage Terrace is for use on the tops of 29¹/₂"H desks, credenzas, and returns.
- Desktop Storage Terrace features six storage sections plus top display shelf.
- Desktop Storage Terrace includes protective, non-slip pads on the base.
- See pages 298-325 for shared components.

! In some cases, installation of Stacked Paper Management may require removing the stack-on or wall mount storage doors.

HOW TO SPECIFY

| | |
|---|---|
| Select Model Number H L V P M 1 . N | Select Laminate See pages 266-267 |
|---|---|

10500 SERIES™

Shared Components & Accessories

GSA SIN 33721

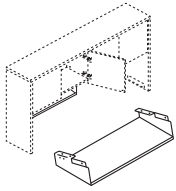

Icon Legend on page 19

**DESCRIPTION****Hanging Paper Shelf**28¹/₁₆"W x 11⁷/₁₆"D x 4³/₁₆"H**MODEL****HHPS1****SHIP WEIGHT**

7

CUBE

2.9

LIST PRICE**\$214**

NOTES: Maximizes worksurface space; de-clutters desktop while placing priority communications and active project folders within easy reach. Angled design allows contents to be distinguished at a glance. Mixed material styling features strong painted metal frame with a frosted shelf.

Attaches quickly and easily to stack-on and wall mount storage models in the following series: 10500, 10700, Valido, 94000, and Voi (except the 36"W overhead hutch with O-legs or panel mount brackets). Not for use with 38000 Series.

For additional information see the Workplace Tools section in the 2021 Shared Spaces Pricer.

Specify: Model.Paint

SPECIFYING EXAMPLE: HHPS1.T1

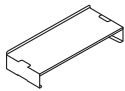
**Desktop Paper Shelf**28¹/₁₆"W x 11⁵/₁₆"D x 5"H**HDPS1**

7

2.9

\$214

NOTES: Organizer shelf provides a place and space for work-in-process and piling to keep worksurfaces neat and tidy. Convenient, scalable design with interlocking side supports allow two units to be stacked and integrated. Durable painted metal frame with a frosted shelf; mixed material styling matches hanging paper shelf.

Can also be used inside select overhead storage, including the following stack-on with hinged door models: 10500 and Valido 36", 42", 66", 72", 78"W and 10700 68⁵/₁₆"W.

For additional information see the Workplace Tools section in the 2021 Shared Spaces Pricer.

Specify: Model.Paint

SPECIFYING EXAMPLE: HDPS1.T1

**Storage Cube**

12"W x 12"D

HL1212

1

0.3

\$316

SPECIFYING EXAMPLE: HL1212.P8S

**NOTES:**

- For 10500 Series™ matching Occasional Tables, see page 321.
- Desktop Paper Shelf includes protective, non-slip pads on the base.
- Paper Shelf can stack two-high.
- Hanging Paper Shelf attaches quickly and easily (screws included).
- See pages 298-325 for shared components.
- For additional information see the Workplace Tools section in the 2021 Shared Spaces Pricer.

HOW TO SPECIFY

Select
Model Number

HHPS1.

Select
Paint Color

See page 183

T1



10500 Series™ Laminate Occasional Tables

| | DESCRIPTION | MODEL | SHIP WEIGHT | CUBE | LIST PRICE |
|---|---|---------------|-------------|------|--------------|
|  | Coffee Table 48"W x 20"D x 16"H | H80191 | 48 | 3.4 | \$541 |
|  | Corner Table 24"W x 24"D x 20"H | H80192 | 35 | 2.1 | \$466 |
|  | End Table 24"W x 20"D x 20"H | H80193 | 29 | 1.8 | \$445 |

Laminate Occasional Tables (H80191, H80192 and H80193)

| Woodgrain | Solid | Patterned | Two-Tone | |
|--|---|---|---|---|
| Bourbon Cherry (HH) Cognac (COGNCOGN) Florence Walnut (LFWILFW1) Harvest (CC) Kingswood Walnut (LKIILK1I) Mahogany (NN) Mocha (MOCHMOCH) Natural Maple (DD) Pinnacle (PINCPINC) Shaker Cherry (FF) Sterling Ash (LSA1LSA1) | Black (PP) Charcoal (SS) Designer White (LDWILDW1) Loft (LOFTLOFT) | Canyon Zephyr (K9) Desert Zephyr (K8) Grey Tigris (L6*) Sheer Mesh (A5) Silver Mesh (B9) *Select edge/apron/leg color Black (P) Bourbon Cherry (H) Charcoal (S) Cognac (COGN) Designer White (LDW1) Florence Walnut (LFW1) Harvest (C) Kingswood Walnut (LK1I) Mahogany (N) Mocha (MOCH) Natural Maple (D) Pinnacle (PINC) Shaker Cherry (F) Sterling Ash (LSA1) | Black/Charcoal (PS) Black/Designer White (PLDW1) Bourbon Cherry/Black (HP) Bourbon Cherry/Charcoal (HS) Bourbon Cherry/Designer White (HLDW1) Charcoal/Black (SP) Charcoal/Designer White (SLDW1) Cognac/Black (COGNP) Cognac/Charcoal (COGNS) Cognac/Designer White (COGNLDW1) Designer White/Black (LDW1P) Designer White/Bourbon Cherry (LDWIH) Designer White/Charcoal (LDW1S) Designer White/Cognac (LDWICOGN) Designer White/Florence Walnut (LDWILFW1) Designer White/Harvest (LDW1C) Designer White/Kingswood Walnut (LDWILK1I) Designer White/Mahogany (LDWIN) Designer White/Mocha (LDW1MOCH) Designer White/Natural Maple (LDW1D) Designer White/Pinnacle (LDW1PINC) Designer White/Sterling Ash (LDW1LSA1) | Designer White/Shaker Cherry (LDW1F) Florence Walnut/Black (LFW1P) Florence Walnut/Charcoal (LFW1S) Florence Walnut/Designer White (LFWILDW1) Florence Walnut/Loft (LFW1LOFT) Harvest/Black (CP) Harvest/Charcoal (CS) Harvest/Designer White (CLDW1) Kingswood Walnut/Black (LK1IP) Kingswood Walnut/Charcoal (LK1IS) Kingswood Walnut/Designer White (LK1ILDW1) Kingswood Walnut/Loft (LK1ILOFT) Mahogany/Black (NP) Mahogany/Charcoal (NS) Mahogany/Designer White (NLDW1) Mocha/Black (MOCHP) Mocha/Charcoal (MOCHS) Mocha/Designer White (MOCHLDW1) Natural Maple/Black (DP) Natural Maple/Charcoal (DS) Natural Maple/Designer White (DLDW1) Pinnacle/Black (PINCP) Pinnacle/Charcoal (PINCS) Pinnacle/Designer White (PINCLDW1) Shaker Cherry/Black (FP) Shaker Cherry/Charcoal (FS) Shaker Cherry/Designer White (FLDW1) Sterling Ash/Black (LSA1P) Sterling Ash/Charcoal (LSA1S) Sterling Ash/Designer White (LSA1LDW1) |

NOTES:

- Durable material and construction make laminate occasional tables ideal for high traffic areas such as lobbies, reception rooms and lounges. Versatile design is also well suited to private offices.
- Tables accommodate lamps, magazines, telephones, plants, laptops and more.
- Coffee, Corner and End Tables feature top-over-apron styling with square corner detail, which complements many interiors and furniture designs.
- Tops are abrasion- and stain-resistant laminate over 1/8" thick solid core high-performance particleboard.
- See pages 298-325 for shared components.

HOW TO SPECIFY

| | |
|---|---|
| <p>Select Model Number</p> <p>H 8 0 1 9 1 .</p> <p>H 8 0 1 9 1 .</p> | <p>Select Laminate</p> <p>See above</p> <p>NN</p> <p>L 6 N</p> |
|---|---|

10500 Series™ Shared Components & Accessories

GSA SIN 33721

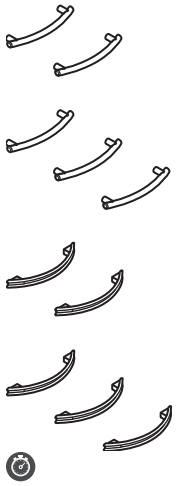

Icon Legend on page 19

**DESCRIPTION****Field Installable Drawer/Door Handle Kits**

Sweep Black, 2-pack
Sweep Satin Nickel, 2-pack

MODEL

HSWEEPA2
HSWEEPC2

SHIP WEIGHT

0.4
0.4

CUBE

0.3
0.3

LIST PRICE

\$47
\$47

Sweep Black, 3-pack
Sweep Satin Nickel, 3-pack

HSWEEPA3
HSWEEPC3

0.5
0.5

0.3
0.3

\$61
\$61

Crescent Black, 2-pack
Crescent Satin Nickel, 2-pack

HCRESCENTA2
HCRESCENTC2

0.4
0.4

0.3
0.3

\$47
\$47

Crescent Black, 3-pack
Crescent Satin Nickel, 3-pack

HCRESCENTA3
HCRESCENTC3

0.5
0.5

0.3
0.3

\$61
\$61

NOTES: Handles are for purchase and field installation on 10500 or 10700 Series™ desks, credenzas, returns, and lateral files, as well as for the modular pedestals used with 10700 and 10500.

Applications include:

- box/file and file/file pedestals = one 2-pack per pedestal
- box/box/file and pencil/media/file pedestals = one 3-pack per pedestal
- two drawer lateral file = two 2-packs per unit
- four drawer lateral file = four 2-packs per unit

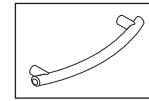
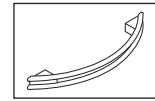
**Sweep Handle****Crescent Handle**

The hole spacing for the Sweep and Crescent handles is 96mm (approx. 3¾"). Important note: effective January 1, 2007, the holes used for the black drawer/door handle that comes standard on several HON 10500 and 10700 Series™ products, including mobile pedestals, storage cabinet with doors, storage/file cabinet, storage cabinet/lateral file, personal wardrobe/storage cabinets, and personal storage towers, will accept the Sweep and Crescent handles. Units manufactured prior to January 1, 2007, have 64mm (approx. 2½") hole spacing and will not accept the Sweep and Crescent handles. Instructions include mounting hardware and paper template.

! Must be ordered with a configurable end product. If ordered separately, not on GSA contract.

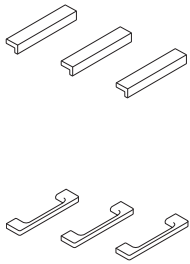
**Field Installable Drawer/Door Handle Kits**

Linear, Black, 2-pack
Linear, Matte Chrome, 2-pack

HLINEARA2
HLINEARC2

0.4
0.4

0.3
0.3

\$61
\$61

Linear, Black, 3-pack
Linear, Matte Chrome, 3-pack

HLINEARA3
HLINEARC3

0.5
0.5

0.3
0.3

\$69
\$69

Specify Linear handles in black to coordinate with 10500 Series™ models that ship standard with a decorative handle, such as mobile pedestals, storage cabinets and wardrobes.

Arch, Black, 2-pack
Arch, Matte Chrome, 2-pack

HARCHA2
HARCHC2

0.4
0.4

0.3
0.3

\$61
\$61

Arch, Black, 3-pack
Arch, Matte Chrome, 3-pack

HARCHA3
HARCHC3

0.5
0.5

0.3
0.3

\$69
\$69

NOTES: Handles are for purchase and field installation on 10500 or 10700 Series™ desks, credenzas, returns, lateral files and modular pedestals. Instructions include mounting hardware and paper template for drilling holes.

Applications include:

- box/file and file/file pedestals = one 2-pack per pedestal
- box/box/file and pencil/media/file pedestals = one 3-pack per pedestal
- two drawer lateral file = two 2-packs per unit
- four drawer lateral file = four 2-packs per unit

The Linear and Arch handles can be attached using 96mm (approx. 3¾") or 128mm (approx. 5") hole spacing. Important note: effective January 1, 2007, the holes used for the black drawer/door handle that comes standard on several HON 10500 and 10700 Series™ products, including mobile pedestals, storage cabinet with doors, storage/file cabinet, storage cabinet/lateral file, personal wardrobe/storage cabinets, and personal storage towers, will accept the Linear and Arch handles. Units manufactured prior to January 1, 2007, have 64mm (approx. 2½") hole spacing and will not accept the Linear and Arch handles.

! Must be ordered with a configurable end product. If ordered separately, not on GSA contract.

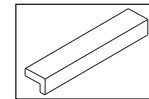
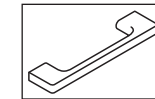
**Linear Handle****Arch Handle****NOTES:**

- Field Installable Drawer/Door Handle Kits for use on 10500 Series™ desks, credenzas, returns and lateral files.
- A metal template is available to facilitate field installation of the Linear, Arch, Sweep and Crescent decorative handles on 10500 and 10700 Series™ drawer fronts; order model SPLH-SYST-DRKNB.M263164.
- See pages 298-325 for shared components.

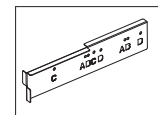
**Metal Template****HOW TO SPECIFY**







Select
Model Number

H S W E E P A 2

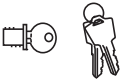

Icon Legend on page 19

10500 SERIES™ Shared Components & Accessories

| | DESCRIPTION | MODEL | SHIP WEIGHT | CUBE | LIST PRICE |
|--|--|--------------|---|------|-------------|
|  SIN 33721  | Black Removable Lock Core Kit | HF23B | 0.1  | 0.1 | \$35 |
| | Satin Removable Lock Core Kit | HF23S | 0.1  | 0.1 | \$47 |
| | <ul style="list-style-type: none"> Specify quantity of each key number from 101E-225E. Includes: 1-core, 2-keys, 1-core removal tool, and instructions. <p>NOTES: Lock with a removable cylinder that can be interchanged as needed; allows users to access all furniture pieces in an office with a single key for convenience and security. Makes re-keying quick and easy. For use in all 10500 Series™ product lock cores, except the stack-on and wall mounted storage “K” models. For the latter use model HF27B or HF27S, listed below.</p> | | | | |
|   | Removable Lock Core Kit | | | | |
| | Black HF27B 0.2 0.02 \$35 Satin HF27S 0.2 0.02 \$35 | | | | |
| | <ul style="list-style-type: none"> For stack-on and wall mounted storage laminate models (with locks) in 10500, 10700, Valido, Voi, Concinnity, and 94000 Series. Specify quantity of each key number from 101E to 225E. Includes: 1-core, 2-keys, 1-core removal tool, and instructions. <p>NOTES: If key number isn't specified, number will be at random.</p> | | | | |

NOTES:

- See pages 298-325 for shared components.
- For master key, see model HF22 on page 773.

HOW TO ORDER CORE REMOVABLE LOCK KITS:





Specify: Model Number.X
Key Number

Examples: HF23S.X121E
HF23S.X (Key number not specified)

NOTES: Key orders without numbers specified will be keyed at random.
Numbers 101E-225E are available.

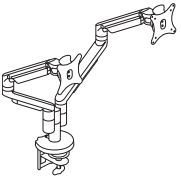
SAMPLE ORDER:

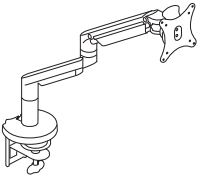
| Quantity | Model | Key Code |
|----------|--------|----------|
| 4 | HF23B. | X121E |

| | DESCRIPTION | MODEL | SHIP WEIGHT | CUBE | LIST PRICE |
|---|--|---------------|--|------|--------------|
|  | Dual Dynamic Monitor Arm | HMASD | 17.0  | 1.1 | \$962 |
| | <ul style="list-style-type: none"> 150° of rotation at base with optional 360° rotation. Arms extend 22" and retract up to 3". Monitor mount rotates 180° and tilts +/-30°. Monitor can be rotated from landscape to portrait position. <p> Arms hold monitors from 6.2-18 lbs. Optional counterweight HPACW available to support monitors as low as 5 lbs. (see the Workplace Tools section in the 2021 Shared Spaces Pricer).</p> | | | | |
|  | Single Dynamic Monitor Arm | HMASTS | 11.5  | 0.8 | \$501 |
| | <ul style="list-style-type: none"> 180° of rotation at base with optional 360° rotation. Arms extend 22" and retract up to 3". Monitor mount rotates 180° and tilts +/-30°. Monitor can be rotated from landscape to portrait position. <p> Arms hold monitors from 6.2-18 lbs. Optional counterweight HPACW available to support monitors as low as 5 lbs. (see the Workplace Tools section in the 2021 Shared Spaces Pricer).</p> | | | | |

HOW TO SPECIFY

| | |
|-----------------------------------|--|
| <p>Select Model Number</p> | <p>Select Finish</p> <p><i>Specify for models HMASD and HMASTS only</i></p> <p>SVR Silver BLK Black</p> |
| <p>HMASD.</p> | <p>SVR</p> |

10500 Series™ Shared Components & Accessories

GSA SIN 33721T EXCEPT AS NOTED

ABI

Icon Legend on page 19



SIN 33721

DESCRIPTION**Field Installable Grommet**

- Intended for use in tops and end panels to route/hide cords and in modesty panels to facilitate reaching wall electrical outlets.
- Grommet is field installable.
- Grommet shape is round.
- Includes grommet cap and sleeve.
- Grommet cap measures 3" diameter and includes a 3/4" diameter cord access hole.
- Grommet sleeve measures 2 1/2" O.D. x 3/4" thick.
- Includes instructions to locate grommet position for desks, credenzas, returns and bridges.

NOTES: For additional information see the Workplace Tools section in the 2021 Shared Spaces Pricer.

! Black Finish

! Requires a 2 1/2" diameter hole saw and drill for installation (not included).

MODEL**HFLDGRMT****SHIP WEIGHT**

0.1 Ⓢ

CUBE

0.01

LIST PRICE**\$35**

SIN 33721

Field Installable Grommet

- Intended for use in tops and end panels to route/hide cords and in modesty panels to facilitate reaching wall electrical outlets.
- Grommet is field installable.
- Grommet shape is round.
- Includes grommet cap and sleeve.
- Grommet outside dimensions measure 3 1/2" diameter and includes two cord access holes.
- Grommet sleeve measures 3" O.D. x 1" thick.
- Includes instructions to locate grommet position for desks, credenzas, returns and bridges.

NOTES: For additional information see the Workplace Tools section in the 2021 Shared Spaces Pricer.

! Black Finish

! Requires a 3" diameter hole saw and drill for installation (not included).

HFLDGRMT3

0.1 Ⓢ

0.3

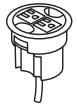
\$35**Power Hub, 3" Grommet Mount, 6' Cord**

- Brings the ease of plug-and-play to the desktop.
- Fits in 3" round grommet holes in 10500 Series™ desks, credenzas and returns; not compatible with 10500 Series™ 2 1/2" round grommets.
- Two grounded AC power outlets.
- Two cord pass-through holes in cap.
- Includes 6' cord with three-prong plug.
- For field installation.
- UL Listed.

NOTES: For additional information see the Workplace Tools section in the 2021 Shared Spaces Pricer.

! Available in Black only (no color designation - Specify: HGRMTAC.X).

HGRMTAC

1.3

0.2

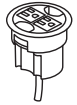
\$126**3" Round Power Grommet - 2 Outlets, 10' Cord**

- Includes 10' cord with three-prong plug.
- Fits in 3" round grommet holes on the following product lines: Coordinate, Huddle, Motivate, all laminate casegoods series, and Systems Worksurfaces.
- Two grounded AC power outlets.
- Field installed with Plug-and-play ease.

NOTES: Power Modules will also work with standing-height applications for 10500 Series™ and Voi® desks. Optional Memory Control allows preset worksurface heights for consistency. Ships separately. Dynamic load capacity when worksurface is moving is 300 lbs.

! Available in black finish only, no specification needed.

HGRMTAC2

1.5

0.2

\$159**Power/USB Hub, 3" Grommet Mount**

- Brings the ease of plug-and-play to the desktop.
- Fits in 3" round grommet holes in 10500 Series™ desks, credenzas and returns; not compatible with 10500 Series™ 2 1/2" round grommets.
- One grounded AC power outlet with 2 USB ports.
- Two cord pass-through holes in cap.
- Includes 6' cord with three-prong plug.
- For field installation.
- UL Listed.

NOTES: For additional information see the Workplace Tools section in the 2021 Shared Spaces Pricer.

! Available in black only (no color designation so use .X - Specify: HGRMTUSB2.X).

HGRMTUSB2

1.3 Ⓢ

0.02

\$250**NOTES:**

- See pages 298-325 for shared components.

HOW TO SPECIFYSelect
Model Number

H F L D G R M T



Icon Legend on page 19

10500 SERIES™ Shared Components & Accessories



SIN 33721

DESCRIPTION

Articulating Desk Lamp
Articulating Desk Lamp w/ Occupancy Sensor

MODEL **SHIP WEIGHT** **CUBE** **LIST PRICE**

HLED1 1.2 Ⓢ 6.5 **\$430**
HLED10C 1.2 Ⓢ 6.5 **\$524**

NOTES: For additional information see the Workplace Tools section in the 2021 Shared Spaces Pricer.

! Silver finish only, no specification needed.



SIN 33721

Task Desk Lamp

HLED2 0.7 Ⓢ 3.0 **\$373**

NOTES: For additional information see the Workplace Tools section in the 2021 Shared Spaces Pricer.

! Brushed nickel finish only, no specification needed.

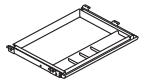

OPEN MARKET

Polymer Center Drawer

HCD1 7.0 0.5 **\$126**

- Color: Black.
- Material: ABS.
- Minimum clearance for mounting: 23"W x 16¼"D x 2"H.
- Retracts on 16" ball-bearing slides.
- Can be used on worksurfaces with Coordinate™ Height Adjustable Bases as long as it is attached with spacer model HKBS.
- Can store up to 25 lbs.

! Black finish only, no specification needed.

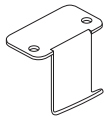

OPEN MARKET

Back Pack Hook (10 per carton)

12"W x 14½"D x 1½"H

HCLA65 10.0 Ⓢ 0.1 **\$101**

NOTES: Assembly: attaches to bottom of desk with (2) screws, included.

! Available in Platinum Metallic finish only, no specification needed.



DESCRIPTION

MODEL

SHIP WEIGHT **CUBE**

LIST PRICE BY PAINT GRADE
P1 **P2**

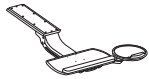

Slide-Away Keyboard Platform (Specify: Laminate) **H4022**

10 Ⓢ 0.6 **\$228**

Extended Tray Slide-Away Keyboard Platform **HE4022**

12 Ⓢ 0.7 **\$323**

(Specify: Laminate)

Metal Keyboard and Mouse Tray (Specify paint) **H4028 OPEN MARKET**

11 Ⓢ 1.5 **\$164** **\$174**

Metal Keyboard Tray (Specify paint) **H4029 OPEN MARKET**

11 Ⓢ 1.5 **\$148** **\$158**

NOTES: For additional information see the Workplace Tools section in the 2021 Shared Spaces Pricer.

Refer to the Workplace Tools section in the 2021 Shared Spaces Pricer for additional product information

SIN 33721



NOTES:

- See pages 298-325 for shared components.

HOW TO SPECIFY

Select Model Number

H L E D 1

10500 SERIES™

Accessories

OPEN MARKET

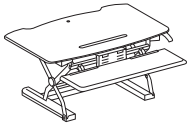

Icon Legend on page 19

**DESCRIPTION**

Coordinate™ Portable Desktop Riser
31"D x 5"-16½"H x 35"W

MODEL**HBXRISER****SHIP WEIGHT**

54.0

CUBE

4.1

LIST PRICE**\$657**

NOTES: Available in Black (BLK) or White (WHT) finish. Desktop riser dimensions (without keyboard tray): 22"D x 5"-16½"H x 35"W. Keyboard tray dimensions: 9"D x 30"W. Max loading capacity is 33 lbs for the desktop riser surface and 4 lbs for the keyboard tray. Easily transition from seated to standing positions throughout the workday. Sits atop an existing desk to create sit-to-stand functionality by raising the computer. Includes keyboard tray and surface for computer monitors. **HON 5-Year Limited Warranty.**

⚠ Not intended for use on mobile workstations.

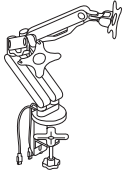
**Dual Monitor Arm with 2 USB Ports****HBDMAUSB**

41.9

2.6

\$410

NOTES: Easy adjustment. Height adjusts to 17" tall. Monitor tilt and swivel capability. Enclosed cable management. Grommet or desktop mounting. Clean appearance. In some applications the Monitor Arms may extend 12 or more inches into the worksurface. For additional information see the Workplace Tools section in the 2021 Shared Spaces Pricer. **HON 5-Year Limited Warranty.**

⚠ No specification needed.

HOW TO SPECIFY

Select
Model Number

Select
Finish

BLK Black
WHT White

HBXRISER.

BLK



Icon Legend on page 19

10500 SERIES™ Accessories

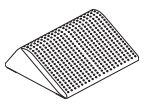
| | DESCRIPTION | MODEL | SHIP WEIGHT | CUBE | LIST PRICE |
|---|---|----------------------|-------------|------------|--------------------|
|  | <p>Footrest — Anti-Slip Cover 13¾"D x 5½"H x 16"W</p> <p>ⓘ Available in Black (T) finish ONLY. Recommended weight capacity not to exceed 250 pounds. HON 5-Year Limited Warranty. SPECIFYING EXAMPLE: HVL991.T</p> | <p>HVL991</p> | <p>7 ⓘ</p> | <p>0.9</p> | <p>\$89</p> |

HOW TO SPECIFY

| | |
|--|---|
| <p>Select Model Number</p> <p>H V L 9 9 1 .</p> | <p>Select Finish</p> <p>T Black</p> <p>T</p> |
|--|---|

10700 SERIES™

Want to see more? Scan here
to check out hon.com.



10700 Series™ Teaming Workstations
shown with Ignition® and Flock® Seating.

10700 SERIES™

Talk about a high achiever! The versatile 10700 Series offers a wide selection of layout configurations — making it easy to get the clean, cohesive look your office needs. Designed to withstand frequent moving and reconfiguration, the 10700 Series boasts contract grade high-pressure laminate and a durable inner-frame construction. Whatever the look you go for, this all-around performer is a smart choice.



FEATURES

- Contoured, solid wood accents and waterfall-shaped edges combine form and function for lasting comfort.
- Make the most of both large and small spaces with flexible storage options that work well together.
- With a variety of mixed materials to choose from, you can customize your look to perfectly match your aesthetic.
- Available in eight woodgrain patterns, our laminate desks are the definition of scratch-, spill- and stain-resistant durability.

10700 SERIES™ ORDERING INFORMATION

LAMINATE FINISHES AVAILABILITY

L1 LAMINATES CODES

Woodgrain

- ◆ Bourbon Cherry **HH**
- ◆ Cognac **COGNCOGN**
- ◆ Harvest **CC**
- ◆ Mahogany **NN**
- ◆ Mocha **MOCHMOCH**
- ◆ Natural Maple **DD**
- ◆ Pinnacle **PINCPINC**
- ◆ Shaker Cherry **FF**

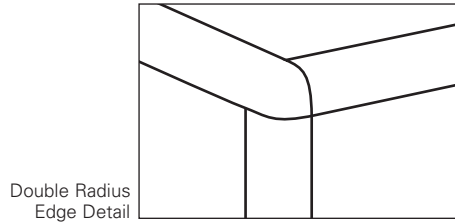

◆◆◆ For lead time information see page 19.

10700 SERIES™

Typicals



Icon Legend on page 19

Components used are listed on pages 336-357. Order components individually. Other configurations are possible, including various sizes of some components.

| QTY | DESCRIPTION | MODEL | LIST PRICE | PRICE EXTENSION |
|---------------|---|--------|----------------|-----------------|
| 1 | Double Pedestal Desk – 2/2 60"W x 30"D x 29½"H | H10771 | \$1,576 | \$1,576 |
| 1 | Credenza with Kneespace – 2/0/2 60"W x 24"D x 29½"H | H10765 | \$1,503 | \$1,503 |
| TOTAL: | | | \$3,079 | |

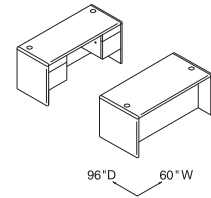

DESK WORKSTATION
60"W x 96"D

| QTY | DESCRIPTION | MODEL | LIST PRICE | PRICE EXTENSION |
|---------------|---|---------|----------------|-----------------|
| 1 | Corner Unit 24" x 36" x 36" x 24" x 29½"H | H107811 | \$1,381 | \$1,381 |
| 1 | Return, Right – B/F 48"W x 24"D x 29½"H | H10715R | \$1,044 | \$1,044 |
| 1 | Return, Left – B/F 48"W x 24"D x 29½"H | H10716L | \$1,044 | \$1,044 |
| 1 | Stack-on Storage 44½"W x 14½"D x 37½"H | H107313 | \$1,231 | \$1,231 |
| TOTAL: | | | \$4,700 | |

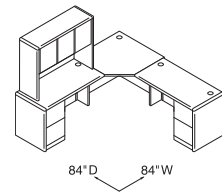

CORNER "L" WORKSTATION
84"W x 84"D

| QTY | DESCRIPTION | MODEL | LIST PRICE | PRICE EXTENSION |
|---------------|--|---------|----------------|-----------------|
| 1 | Single Pedestal Desk, Left – B/F 72"W x 36"D x 29½"H | H10786L | \$1,552 | \$1,552 |
| 1 | Bridge 47"W x 24"D x 29½"H | H10770 | \$472 | \$472 |
| 1 | Credenza with Lateral, Right 72"W x 24"D x 29½"H | H10747R | \$1,874 | \$1,874 |
| 1 | Stack-on Storage 68½"W x 14½"D x 37½"H | H10734 | \$1,396 | \$1,396 |
| TOTAL: | | | \$5,294 | |

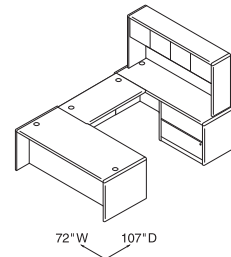

DESK "U" WORKSTATION – RIGHT
72"W x 107"D

| QTY | DESCRIPTION | MODEL | LIST PRICE | PRICE EXTENSION |
|---------------|--|--------|----------------|-----------------|
| 1 | Double Pedestal Desk – 3/2 72"W x 36"D x 29½"H | H10799 | \$2,398 | \$2,398 |
| 1 | Credenza with Storage 72"W x 24"D x 29½"H | H10742 | \$2,398 | \$2,398 |
| TOTAL: | | | \$4,796 | |

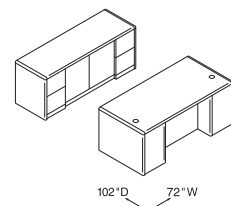

**DESK WORKSTATION WITH
STORAGE CRENDENZA**
72"W x 102"D



Icon Legend on page 19

10700 SERIES™ Typicals

Components used are listed on pages 336-357. Order components individually. Other configurations are possible, including various sizes of some components.

| QTY | DESCRIPTION | MODEL | LIST PRICE | PRICE EXTENSION |
|---------------|---|----------|----------------|-----------------|
| 1 | Double Pedestal Desk – 3/2 72"W x 36"D x 29½"H | H10799 | \$2,398 | \$2,398 |
| 1 | Credenza with Kneespace – 2/0/2 72"W x 24"D x 29½"H | H10741 | \$2,071 | \$2,071 |
| 1 | Stack-on Storage 68⅝"W x 14⅝"D x 37⅞"H | H10734 | \$1,396 | \$1,396 |
| 1 | Wardrobe/Storage Cabinet, Right 18"W x 24"D x 66⅝"H | H107295R | \$2,121 | \$2,121 |
| TOTAL: | | | \$7,986 | |

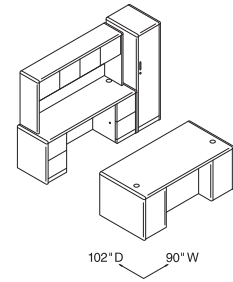

DESK WORKSTATION
90"W x 102"D

| QTY | DESCRIPTION | MODEL | LIST PRICE | PRICE EXTENSION |
|---------------|--|----------|----------------|-----------------|
| 1 | Peninsula 72"W x 36"D x 29½"H | H10721E | \$1,529 | \$1,529 |
| 1 | Return, Left – F/F 42"W x 24"D x 29½"H | H107192L | \$1,259 | \$1,259 |
| 1 | Stack-on Storage 74⅝"W x 14⅝"D x 37⅞"H | H107318 | \$1,533 | \$1,533 |
| TOTAL: | | | \$4,321 | |

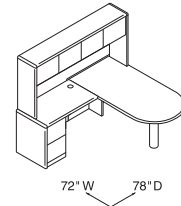

PENINSULA "L" WORKSTATION – LEFT
72"W x 78"D

| QTY | DESCRIPTION | MODEL | LIST PRICE | PRICE EXTENSION |
|---------------|---|---------|----------------|-----------------|
| 1 | Single Pedestal Desk, Right – B/B/F 66"W x 30"D x 29½"H | H10701R | \$1,904 | \$1,904 |
| 1 | Return, Left – F/F 48"W x 24"D x 29½"H | H10712L | \$1,274 | \$1,274 |
| 1 | Stack-on Storage 74⅝"W x 14⅝"D x 37⅞"H | H107318 | \$1,533 | \$1,533 |
| 1 | 2-Drawer Lateral File 36"W x 24"D x 29½"H | H107690 | \$1,390 | \$1,390 |
| TOTAL: | | | \$6,101 | |

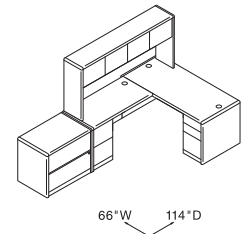

DESK "L" WORKSTATION – LEFT
66"W x 114"D

| QTY | DESCRIPTION | MODEL | LIST PRICE | PRICE EXTENSION |
|---------------|--|---------|----------------|-----------------|
| 1 | Peninsula 72"W x 36"D x 29½"H | H10721E | \$1,529 | \$1,529 |
| 1 | Bridge 47"W x 24"D x 29½"H | H10770 | \$472 | \$472 |
| 1 | Credenza Shell with Full Modesty Panel 72"W x 24"D x 29½"H | H107817 | \$1,043 | \$1,043 |
| 1 | Multi File Pedestal 36"W x 20"D x 28"H | H10505 | \$1,324 | \$1,324 |
| 1 | Stack-on Storage 68⅝"W x 14⅝"D x 37⅞"H | H10734 | \$1,396 | \$1,396 |
| TOTAL: | | | \$5,764 | |

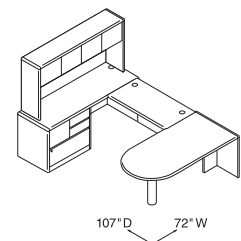

PENINSULA "U" WORKSTATION – LEFT
72"W x 107"D

10700 SERIES™

Typicals



Icon Legend on page 19

Components used are listed on pages 336-357. Order components individually. Other configurations are possible, including various sizes of some components.

| QTY | DESCRIPTION | MODEL | LIST PRICE | PRICE EXTENSION |
|---------------|---|----------|----------------|-----------------|
| 1 | Single Pedestal Desk, Left - B/B/F 72"W x 36"D x 29½"H | H10788L | \$2,071 | \$2,071 |
| 1 | Bridge 47"W x 24"D x 29½"H | H10770 | \$472 | \$472 |
| 1 | Single Pedestal Credenza, Right - F/F 72"W x 24"D x 29½"H | H10707R | \$1,695 | \$1,695 |
| 1 | Stack-on Storage 68⅝"W x 14⅝"D x 37⅞"H | H10734 | \$1,396 | \$1,396 |
| 1 | Wardrobe/Storage Cabinet, Right 18"W x 24"D x 66⅝"H | H107295R | \$2,121 | \$2,121 |
| TOTAL: | | | \$7,755 | |

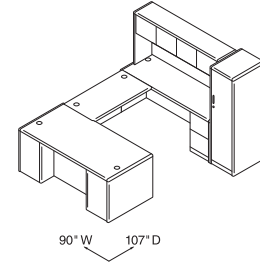

DESK "U" WORKSTATION - RIGHT

90"W x 107"D

| QTY | DESCRIPTION | MODEL | LIST PRICE | PRICE EXTENSION |
|---------------|--|----------|----------------|-----------------|
| 1 | Return Shell, Left 36"W x 24"D x 29½"H | H107802L | \$702 | \$702 |
| 1 | Corner Unit 24" x 36" x 36" x 24" x 29½"H | H107811 | \$1,381 | \$1,381 |
| 1 | Return Shell, Right 36"W x 24"D x 29½"H | H107801R | \$702 | \$702 |
| 1 | Stack-on Storage 68⅝"W x 14⅝"D x 37⅞"H | H10734 | \$1,396 | \$1,396 |
| 1 | Mobile Pedestal - B/B/F 15¾"W x 22¾"D x 28"H | H105102 | \$906 | \$906 |
| 1 | Mobile Pedestal - F/F 15¾"W x 22¾"D x 28"H | H105104 | \$906 | \$906 |
| TOTAL: | | | \$5,993 | |

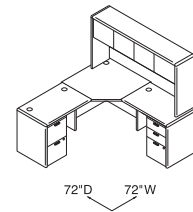

CORNER 6' X 6' WORKSTATION

72"W x 72"D

| QTY | DESCRIPTION | MODEL | LIST PRICE | PRICE EXTENSION |
|---------------|--|---------|----------------|-----------------|
| 1 | Desk Shell 66"W x 30"D x 29½"H | H107826 | \$1,117 | \$1,117 |
| 1 | Credenza Shell 66"W x 24"D x 29½"H | H107816 | \$973 | \$973 |
| 2 | Mobile Pedestal - B/B/F 15¾"W x 22¾"D x 28"H | H105102 | \$906 | \$1,812 |
| 2 | Mobile Pedestal - F/F 15¾"W x 22¾"D x 28"H | H105104 | \$906 | \$1,812 |
| TOTAL: | | | \$5,714 | |

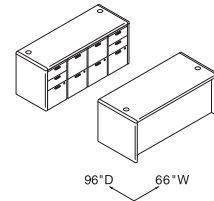

MODULAR DESK AND CREDEZA

66"W x 96"D

| QTY | DESCRIPTION | MODEL | LIST PRICE | PRICE EXTENSION |
|---------------|--|----------|----------------|-----------------|
| 1 | Peninsula 66"W x 30"D x 29½"H | H10722E | \$1,336 | \$1,336 |
| 1 | Bridge 42"W x 24"D x 29½"H | H10760 | \$455 | \$455 |
| 1 | Corner Unit 24" x 36" x 36" x 24" x 29½"H | H107811 | \$1,381 | \$1,381 |
| 1 | Return Shell, Right 42"W x 24"D x 29½"H | H107803R | \$702 | \$702 |
| 1 | Mobile Pedestal - B/B/F 15¾"W x 22¾"D x 28"H | H105102 | \$906 | \$906 |
| 1 | Mobile Pedestal - F/F 15¾"W x 22¾"D x 28"H | H105104 | \$906 | \$906 |
| 1 | Stack-on Storage 74⅝"W x 14⅝"D x 37⅞"H | H107318 | \$1,533 | \$1,533 |
| TOTAL: | | | \$7,219 | |

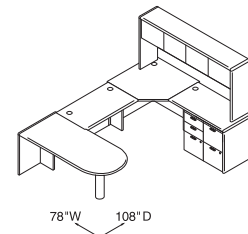

**PENINSULA "U" WITH
MODULAR COMPONENTS**

78"W x 108"D



Icon Legend on page 19

10700 SERIES™ Bundles Typicals

Mahogany H107LL7284N

| QTY | DESCRIPTION | MODEL | LIST PRICE | PRICE EXTENSION |
|---------------|--------------------|---------|----------------|-----------------|
| 1 | Left Pedestal Desk | H10786L | \$1,552 | \$1,552 |
| 1 | Right Return | H10715R | \$1,044 | \$1,044 |
| TOTAL: | | | \$2,596 | |

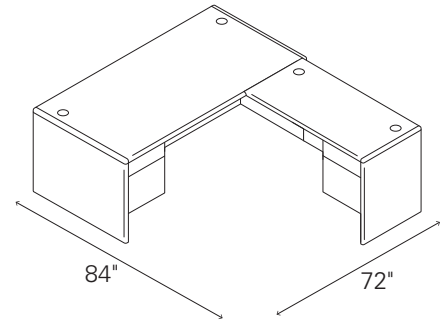

L-STATION (LEFT DESK, RIGHT RETURN)

Mahogany H107LR7284N

| QTY | DESCRIPTION | MODEL | LIST PRICE | PRICE EXTENSION |
|---------------|---------------------|---------|----------------|-----------------|
| 1 | Right Pedestal Desk | H10785R | \$1,552 | \$1,552 |
| 1 | Left Return | H10716L | \$1,044 | \$1,044 |
| TOTAL: | | | \$2,596 | |

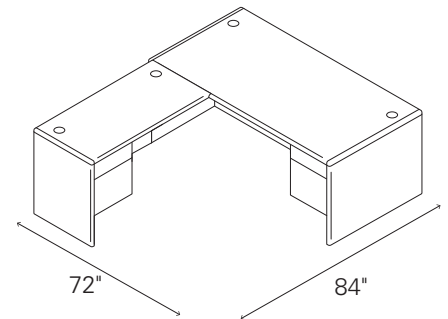

L-STATION (RIGHT DESK, LEFT RETURN)

Mahogany H107UL72108N

| QTY | DESCRIPTION | MODEL | LIST PRICE | PRICE EXTENSION |
|---------------|-------------------------|---------|----------------|-----------------|
| 1 | Left Pedestal Desk | H10786L | \$1,552 | \$1,552 |
| 1 | Right Pedestal Credenza | H10745R | \$1,361 | \$1,361 |
| 1 | Bridge | H10770 | \$472 | \$472 |
| TOTAL: | | | \$3,385 | |

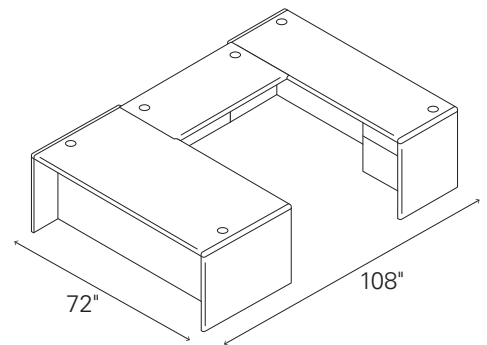

U-STATION (LEFT DESK, RIGHT CREDENZA)

10700 SERIES™

Bundles Typicals



Icon Legend on page 19

Mahogany
H107UR72108N

| QTY | DESCRIPTION | MODEL | LIST PRICE | PRICE EXTENSION |
|---------------|------------------------|---------|----------------|-----------------|
| 1 | Right Pedestal Desk | H10785R | \$1,552 | \$1,552 |
| 1 | Left Pedestal Credenza | H10746L | \$1,361 | \$1,361 |
| 1 | Bridge | H10770 | \$472 | \$472 |
| TOTAL: | | | \$3,385 | |

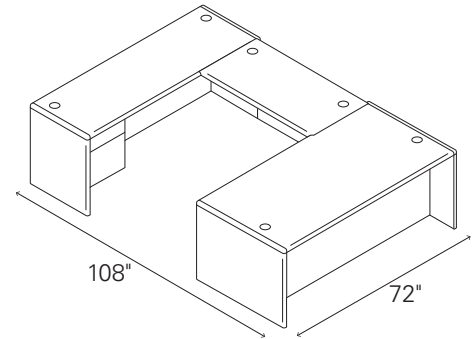

U-STATION (RIGHT DESK, LEFT CREDENZA)

Mahogany
H107LLH7284N

| QTY | DESCRIPTION | MODEL | LIST PRICE | PRICE EXTENSION |
|---------------|--------------------|---------|----------------|-----------------|
| 1 | Left Pedestal Desk | H10786L | \$1,552 | \$1,552 |
| 1 | Right Return | H10715R | \$1,044 | \$1,044 |
| 1 | Stack-on Storage | H107313 | \$1,231 | \$1,231 |
| TOTAL: | | | \$3,827 | |

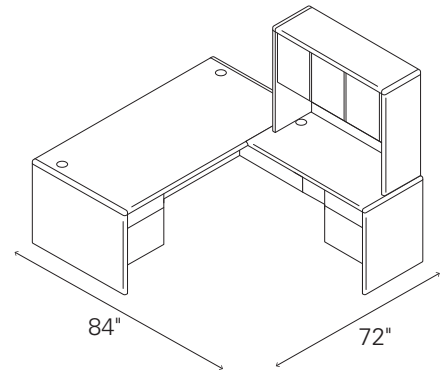

**L-STATION WITH STACK-ON STORAGE
(LEFT DESK, RIGHT RETURN)**

Mahogany
H107LRH7284N

| QTY | DESCRIPTION | MODEL | LIST PRICE | PRICE EXTENSION |
|---------------|---------------------|---------|----------------|-----------------|
| 1 | Right Pedestal Desk | H10785R | \$1,552 | \$1,552 |
| 1 | Left Return | H10716L | \$1,044 | \$1,044 |
| 1 | Stack-on Storage | H107313 | \$1,231 | \$1,231 |
| TOTAL: | | | \$3,827 | |

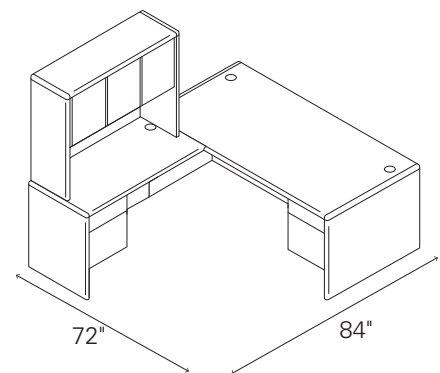

**L-STATION WITH STACK-ON STORAGE
(RIGHT DESK, LEFT RETURN)**



Icon Legend on page 19

10700 SERIES™ Bundles Typicals

DESKS

Mahogany
H107ULH72108N

| QTY | DESCRIPTION | MODEL | LIST PRICE | PRICE EXTENSION |
|---------------|-------------------------|---------|----------------|-----------------|
| 1 | Left Pedestal Desk | H10786L | \$1,552 | \$1,552 |
| 1 | Right Pedestal Credenza | H10745R | \$1,361 | \$1,361 |
| 1 | Bridge | H10770 | \$472 | \$472 |
| 1 | Stack-on Storage | H10734 | \$1,396 | \$1,396 |
| TOTAL: | | | \$4,781 | |

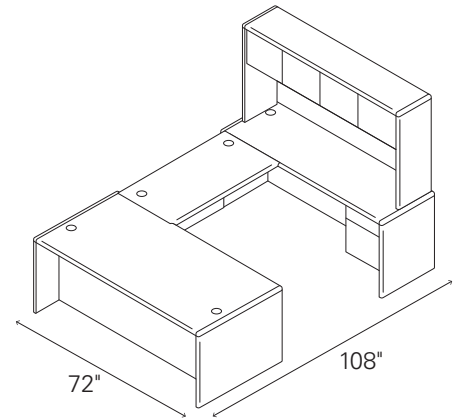

**U-STATION WITH STACK-ON STORAGE
(LEFT DESK, RIGHT CREDENZA)**

Mahogany
H107URH72108N

| QTY | DESCRIPTION | MODEL | LIST PRICE | PRICE EXTENSION |
|---------------|------------------------|---------|----------------|-----------------|
| 1 | Right Pedestal Desk | H10785R | \$1,552 | \$1,552 |
| 1 | Left Pedestal Credenza | H10746L | \$1,361 | \$1,361 |
| 1 | Bridge | H10770 | \$472 | \$472 |
| 1 | Stack-on Storage | H10734 | \$1,396 | \$1,396 |
| TOTAL: | | | \$4,781 | |

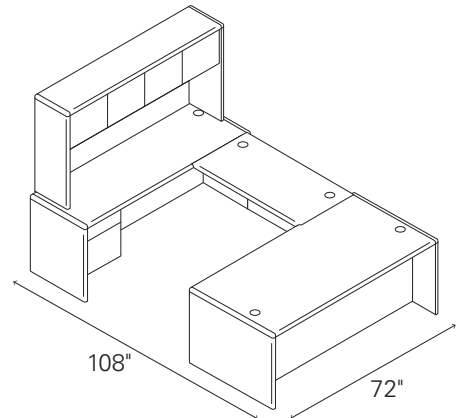

**U-STATION WITH STACK-ON STORAGE
(RIGHT DESK, LEFT CREDENZA)**

10700 SERIES™ Laminate Modular Components

GSA SIN 33721



Icon Legend on page 19

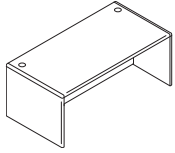

| DESCRIPTION | INSIDE DIMENSIONS | FULL WIDTH OVERHANG | MODEL | SHIP WEIGHT | CUBE | LIST PRICE |
|--|-------------------|---------------------|----------------|-------------|------|---------------|
| Desk Shell w/Full Modesty Panel | | | | | | |
| 72"W x 36"D x 29½"H | 69½"W x 24⅝"D | 10½" | H107827 | 213 | 7.0 | \$1261 |
| 72"W x 30"D x 29½"H | 69½"W x 24⅝"D | 4½" | H107829 | 167 | 4.7 | \$1121 |
| 66"W x 30"D x 29½"H | 63½"W x 24⅝"D | 4½" | H107826 | 175 | 5.5 | \$1117 |
| 60"W x 30"D x 29½"H | 57½"W x 24⅝"D | 4½" | H107825 | 164 | 5.0 | \$967 |
| 48"W x 30"D x 29½"H | 45½"W x 24⅝"D | 4½" | H107824 | 143 | 5.0 | \$939 |

NOTES: Can be used freestanding or connected to a 42"W return shell to achieve a space efficient 6' x 6' L-shaped workstation layout. Accepts stack-on storage models H10734, H10734K or H10734G. See page 356 for optional center drawers.

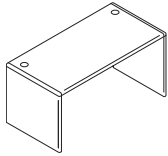

| | | | | | | |
|---------------------------------------|---------------|-----|-----------------|-----|-----|--------------|
| Desk Shell w/10" Modesty Panel | | | | | | |
| 60"W x 30"D x 29½"H | 57½"W x 24⅝"D | 4½" | H107825X | 161 | 4.0 | \$967 |

NOTES: Makes reaching wall electrical outlets quick and easy. Provides more than 18" of clearance. Can be used freestanding or connected to a 30"W return shell to achieve a compact 5' x 5' L-shaped workstation layout. Accepts stack-on storage models H10732, H10732K. See page 356 for optional center drawers.

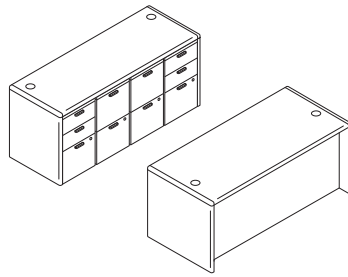

96" D 66" W

- 1 - H107826
- 1 - H107816
- 2 - H105102
- 2 - H105104

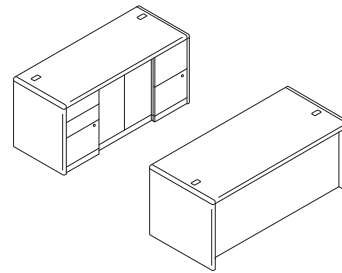

96" D 60" W

- 1 - H107825
- 1 - H107815
- 1 - H10508
- 1 - H10504
- 1 - H10502

! All 10700 Series™ grommets on desk, credenza, credenza shell, return, return shell, bridge and corner unit worksurfaces changed from rectangle-shaped to round, effective November, 2011.

NOTES:



- Desk, credenza, and return shells, combined with a variety of under-the-worksurface storage solutions, maximize office layout flexibility. Products can be reconfigured quickly and easily when user preferences or space needs change.
- Worksurfaces and end panels feature contract-grade scratch, stain and spill resistant laminate over durable 1⅛" solid core high-performance particleboard; resists warping.
- Contoured hardwood trim; stained to match laminate.
- User friendly waterfall-shaped edges and round corners.
- 3" round cord management grommets, for routing and hiding wires and cables, are located in the tops of desk, credenza, and return shells. Grommets also serve as anchor points for stack-on storage and organizers.
- Grommet can be replaced with optional Power Hub or Power/USB Hub for easy plug-and-play. See page 358.
- Shells utilize 10500 Series™ mobile pedestals or modular pedestals. See pages 289-291.
- See pages 340-341 for modular storage components.

HOW TO SPECIFY

| | |
|--|--|
| <p>Select Model Number</p> <p>H 1 0 7 8 2 7 .</p> | <p>Select Laminate</p> <p>See page 329</p> <p>N N</p> |
|--|--|

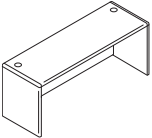
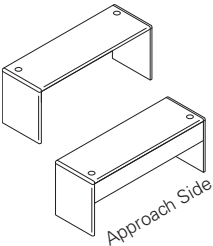

10700 SERIES™ Laminate Modular Components

| | DESCRIPTION | INSIDE DIMENSIONS | MODEL | SHIP WEIGHT | CUBE | LIST PRICE |
|---|---|-------------------|-----------------|-------------|------|---------------|
|  | Credenza Shell w/Full Modesty Panel | | | | | |
| | 72"W x 24"D x 29½"H | 69½"W x 22¾"D | H107817 | 156 | 6.0 | \$1043 |
| | 66"W x 24"D x 29½"H | 63½"W x 22¾"D | H107816 | 145 | 5.5 | \$973 |
| | 60"W x 24"D x 29½"H | 57½"W x 22¾"D | H107815 | 133 | 5.0 | \$918 |
| | 72"W x 20"D x 29½"H | 69½"W x 18¾"D | H107837 | 140 | 5.3 | \$1019 |
| | 66"W x 20"D x 29½"H | 63½"W x 18¾"D | H107836 | 132 | 4.8 | \$949 |
| | 60"W x 20"D x 29½"H | 57½"W x 18¾"D | H107835 | 127 | 3.8 | \$903 |
| | NOTES: One cord pass-through grommet in top center of modesty panel to reach wall electrical outlets. See pages 348-349 for optional stack-on storage. | | | | | |
|  | Credenza Shell w/10"H Modesty Panel | | | | | |
| | 72"W x 24"D x 29½"H | 69½"W x 22¾"D | H107817X | 127 | 6.0 | \$1043 |
| | 66"W x 24"D x 29½"H | 63½"W x 22¾"D | H107816X | 121 | 5.5 | \$973 |
| | 60"W x 24"D x 29½"H | 57½"W x 22¾"D | H107815X | 115 | 5.0 | \$918 |
| | NOTES: Makes reaching wall electrical outlets quick and easy. Provides more than 18" of clearance. See pages 348-349 for optional stack-on storage. | | | | | |
|  <p>Not available in two-tone laminate</p> | Kneespace Clearance End Panel Kits (field installable) | | | | | |
| | 1½"W x 11¼"D x 28⅝"H | | H105098 | 13 | 0.9 | \$223 |
| | For use at either end of 10700, 10500 or Valido Series® 24"D Credenza Shells (with full or 10" modesty panel) or non-pedestal end of single pedestal credenzas or credenzas with lateral files. | | | | | |
| | 1⅝"W x 17¼"D x 28⅝"H | | H105099 | 11 | 0.8 | \$234 |
| | For use at either end of 10700, 10500 or Valido Series® 30"D Desk Shells or non-pedestal end of 30"D single pedestal desks. | | | | | |
| | Kits include: (1) support panel; European fastening hardware; flat connector bracket; joint connector bolts with sleeve nuts (for ganging credenza to adjacent worksurface); and adjustable leveling glides. Allows conversion of units currently in the field. | | | | | |
| | NOTES: Can be used to connect up to three 24"D credenzas or 30"D desks in line (requires 4 kits). | | | | | |
| | ⚠ Not designed to be used freestanding. Not designed to be used with returns, 36"D desks or desk shells. | | | | | |
| | SPECIFYING EXAMPLE: H105098.N | | | | | |

NOTES:

- Desk, credenza, and return shells, combined with a variety of under-the-worksurface storage solutions, maximize office layout flexibility. Products can be reconfigured quickly and easily when user preferences or space needs change.
- Worksurfaces and end panels feature contract-grade scratch, stain and spill resistant laminate over durable 1/8" solid core high-performance particleboard; resists warping.
- Contoured hardwood trim; stained to match laminate.
- User friendly waterfall-shaped edges and rounded corners.
- Formal, full height or 10" modesty panels.
- Cord management grommets, for routing and hiding wires and cables, are located in the tops of desk, credenza, and return shells. Grommets also serve as anchor points for stack-on storage and organizers.
- Shells utilize 10500 Series™ mobile pedestals or modular pedestals. See pages 289-291.
- See pages 340-341 for modular storage components.

HOW TO SPECIFY

| | |
|----------------------------|------------------------|
| Select Model Number | Select Laminate |
| | See page 329 |
| H 1 0 7 8 1 7 . | N N |

10700 SERIES™ Laminate Modular Components

GSA SIN 33721



Icon Legend on page 19

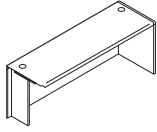

Model H10772R shown

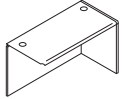

Model H107805R shown

| DESCRIPTION | INSIDE DIMENSIONS | MODEL | SHIP WEIGHT | CUBE | LIST PRICE |
|--|-------------------|-----------------|-------------|------|---------------|
| Right Return Shell w/Full Modesty Panel | | | | | |
| 72"W x 24"D x 29½"H, Right (w/support; 2 grommets) | 67"W x 22¾"D | H10772R | 145 | 5.6 | \$1043 |
| 60"W x 24"D x 29½"H, Right (w/support; 2 grommets) | 55"W x 22¾"D | H107807R | 129 | 4.7 | \$918 |
| 48"W x 24"D x 29½"H, Right (2 grommets) | 47"W x 22¾"D | H107805R | 100 | 4.0 | \$736 |
| 42"W x 24"D x 29½"H, Right (2 grommets) | 41"W x 22¾"D | H107803R | 95 | 3.5 | \$702 |
| 36"W x 24"D x 29½"H, Right (2 grommets) | 34¾"W x 22⅝"D | H107801R | 83 | 3.4 | \$702 |
| 30"W x 24"D x 29½"H (1 grommet) | 28¾"W x 22¾"D | H107725R | 69 | 2.4 | \$681 |
| Left Return Shell w/Full Modesty Panel | | | | | |
| 72"W x 24"D x 29½"H, Left (w/support; 2 grommets) | 67"W x 22¾"D | H107728L | 145 | 5.6 | \$1043 |
| 60"W x 24"D x 29½"H, Left (w/support; 2 grommets) | 55"W x 22¾"D | H107808L | 129 | 4.7 | \$918 |
| 48"W x 24"D x 29½"H, Left (2 grommets) | 47"W x 22¾"D | H107806L | 100 | 4.0 | \$736 |
| 42"W x 24"D x 29½"H, Left (2 grommets) | 41"W x 22¾"D | H107804L | 95 | 3.5 | \$702 |
| 36"W x 24"D x 29½"H, Left (2 grommets) | 34¾"W x 22⅝"D | H107802L | 83 | 3.4 | \$702 |
| 30"W x 24"D x 29½"H (1 grommet) | 28¾"W x 22¾"D | H107726L | 69 | 2.4 | \$681 |

NOTES: One cord pass-through grommet in top center of modesty panel to reach wall electrical outlets. Woodgrain direction on modesty/back panel runs vertical on 30"W-60"W sizes and horizontal on 72"W unit. Stack-on model H10734 is sized to be used on the 72"W return shell. Stack-on model H10732 will work on the 60"W return shell. Stack-on storage model H107313 fits on the 48"W return shell. Stack-on storage model H10734 will work on a 36"W return shell attached to the 36" corner unit; attaches to the return shell through the grommet hole and to the corner unit via double-sided tape. 36"W return shell can be used to achieve a 6' x 6' footprint when connected to either a 72"W x 36"D single pedestal desk, desk shell or peninsula, or when two are connected to a 36" corner unit model H107811.

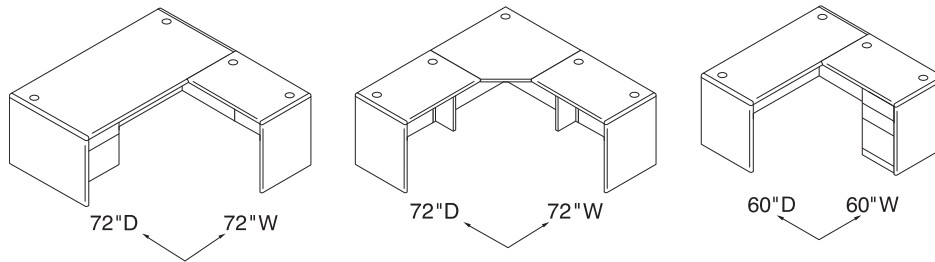

! All 10700 Series™ grommets on desk, credenza, credenza shell, return, return shell, bridge and corner unit worksurfaces changed from rectangle-shaped to round, effective November, 2011.

NOTES:

- Worksurfaces and end panels feature contract-grade scratch, stain and spill resistant laminate over durable 1½" solid core high-performance particleboard; resists warping.
- Contoured hardwood trim; stained to match laminate.
- User friendly waterfall-shaped edges and rounded corners.
- Formal, full height or 10" modesty panels.
- Cord management grommets, for routing and hiding wires and cables, are located in the tops of desk, credenza, and return shells. Grommets also serve as anchor points for stack-on storage and organizers.
- For work-in-process paper management tools, see page 355.
- For conference table options, see the Preside® table tops and bases in the Tables section in the 2021 Shared Spaces Pricer.
- Shells utilize 10500 Series™ mobile pedestals or modular pedestals. See pages 289-291.
- See pages 340-341 for modular storage components.

HOW TO SPECIFY

| | |
|---|---|
| <p>Select Model Number</p> <p>H 1 0 7 7 2 7 R .</p> | <p>Select Laminate</p> <p>See page 329</p> <p>N N</p> |
|---|---|

10700 SERIES™ Laminate Modular Components

| | DESCRIPTION | INSIDE DIMENSIONS | MODEL | SHIP WEIGHT | CUBE | LIST PRICE |
|--|--|-------------------|------------------|-------------|------|---------------|
| | Right Return Shell w/10" H Modesty Panel | | | | | |
| | 72"W x 24"D x 29½"H, Right (w/support; 2 grommets) | 67"W x 22¾"D | H107727RX | 113 | 5.6 | \$1043 |
| | 60"W x 24"D x 29½"H, Right (w/support; 2 grommets) | 55"W x 22¾"D | H107807RX | 105 | 4.7 | \$918 |
| | 48"W x 24"D x 29½"H, Right (2 grommets) | 47"W x 22¾"D | H107805RX | 81 | 4.0 | \$736 |
| | 42"W x 24"D x 29½"H, Right (2 grommets) | 41"W x 22¾"D | H107803RX | 78 | 3.5 | \$702 |
| | 36"W x 24"D x 29½"H, Right (2 grommets) | 34¾"W x 22⅞"D | H107801RX | 69 | 3.4 | \$702 |
| | Left Return Shell w/10" H Modesty Panel | | | | | |
| | 72"W x 24"D x 29½"H, Left (w/support; 2 grommets) | 67"W x 22¾"D | H107728LX | 113 | 5.6 | \$1043 |
| | 60"W x 24"D x 29½"H, Left (w/support; 2 grommets) | 55"W x 22¾"D | H107808LX | 105 | 4.7 | \$918 |
| | 48"W x 24"D x 29½"H, Left (2 grommets) | 47"W x 22¾"D | H107806LX | 81 | 4.0 | \$736 |
| | 42"W x 24"D x 29½"H, Left (2 grommets) | 41"W x 22¾"D | H107804LX | 78 | 3.5 | \$702 |
| | 36"W x 24"D x 29½"H, Left (2 grommets) | 34¾"W x 22⅞"D | H107802LX | 69 | 3.4 | \$702 |

NOTES: Makes reaching wall electrical outlets quick and easy. Provides more than 18" of clearance.

| | | | | | | |
|--|--|---------------|-----------------|----|-----|--------------|
| | Non-Handed Return Shell w/10" H Modesty Panel | | | | | |
| | 30"W x 20"D x 29½"H | 28¾"W x 18¾"D | H107270X | 47 | 2.4 | \$653 |

NOTES: Makes reaching wall electrical outlets quick and easy; provides more than 18" of clearance. Ideal for smaller spaces. Connects to single pedestal desks and credenzas, peninsulas, or desk or credenza shells. Designed to fit over 10500 Series™ mobile pedestal models H105106 (box/file) or H105109 (shelf/box/file) and modular pedestal models H105012 (box/box/file) or H105014 (file/file).

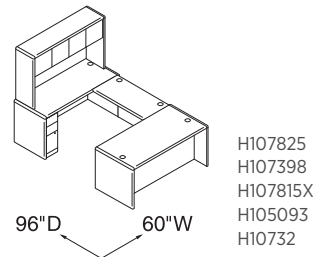
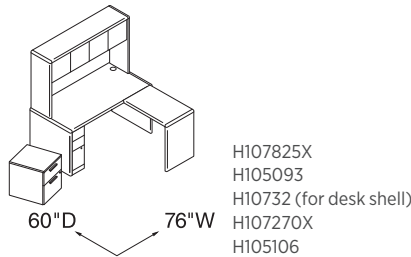

! All 10700 Series™ grommets on desk, credenza, credenza shell, return, return shell, bridge and corner unit worksurfaces changed from rectangle-shaped to round, effective November, 2011.

NOTES:

- Worksurfaces and end panels feature contract-grade scratch, stain and spill resistant laminate over durable 1½" solid core high-performance particleboard; resists warping.
- Contoured hardwood trim; stained to match laminate.
- User friendly waterfall-shaped edges and rounded corners.
- Formal, full height or 10" modesty panels.
- 3" round cord management grommets, for routing and hiding wires and cables, are located in the tops of desk, credenza, and return shells. Grommets also serve as anchor points for stack-on storage and organizers.
- Grommet can be replaced with optional Power Hub or Power/USB Hub for easy plug-and-play. See page 358.
- For conference table options, see the Preside® table tops and bases in the Tables section in the 2021 Shared Spaces Pricer.
- Shells utilize 10500 Series™ mobile pedestals or modular pedestals. See pages 289-291.
- See pages 340-341 for modular storage components.

! Disperse fabrics not available on 72"W panels.

HOW TO SPECIFY

| | |
|---|---|
| <p>Select Model Number</p> <p>H 1 0 7 7 2 7 R X</p> | <p>Select Laminate</p> <p>See page 329</p> <p>N N</p> |
|---|---|

10700 SERIES™

Laminate Modular Components

GSA SIN 33721

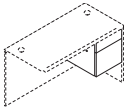
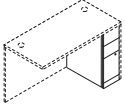
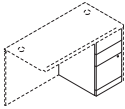
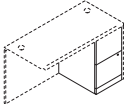
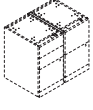

Icon Legend on page 19

| | DESCRIPTION | MODEL | SHIP WEIGHT | CUBE | LIST PRICE |
|--|--|----------------|-------------|------|--------------|
|  | <p>Box/File Pedestal (with core removable lock) 15$\frac{3}{8}$"W x 22$\frac{3}{4}$"D x 17$\frac{3}{4}$"H — for use under 24"D, 30"D and 36"D desk, credenza and return shells</p> <p>NOTES: Hangrails included. Lock can be positioned on either the right or left side. Attaches to underside of worksurface top. Not for use under 20"D shells.</p> <p>⚠ Not designed to be used freestanding. Unfinished top and back.</p> | H10501 | 57 | 5.5 | \$555 |
|  | <p>Narrow Box/Box/File Pedestal (with core removable lock) — floor-standing 9$\frac{1}{2}$"W x 22$\frac{3}{4}$"D x 28"H — for use under 24"D, 30"D and 36"D desk, credenza and return shells</p> <p>NOTES: Compact design is ideal for use in U- and L-shaped layouts for smaller spaces such as 5' x 8' U-workstation or a 5' x 5' L-workstation. Middle box drawer and file drawer lock; top box drawer does not lock. File drawer includes integrated hangrails for side-to-side letter or legal filing. Field installable handle choices for this model are the Sweep, Crescent, and Arch only. Not for use with 20"D shells.</p> <p>⚠ Not designed to be used freestanding; unfinished top and back.</p> | H105093 | 61 | 5.6 | \$717 |
|  | <p>Box/Box/File Pedestal (with core removable lock) — floor-standing 15$\frac{3}{8}$"W x 22$\frac{3}{4}$"D x 28"H — for use under 24"D, 30"D and 36"D desk, credenza and return shells</p> <p>NOTES: Top box drawer does not lock. Hangrails included. Not for use under 20"D shells.</p> <p>⚠ Not designed to be used freestanding. Unfinished top and back.</p> | H10502 | 90 | 8.4 | \$728 |
|  | <p>File/File Pedestal (with core removable lock) — floor-standing 15$\frac{3}{8}$"W x 22$\frac{3}{4}$"D x 28"H — for use under 24"D, 30"D and 36"D desk, credenza and return shells</p> <p>NOTES: Hangrails included. Not for use under 20"D shells.</p> <p>⚠ Not designed to be used freestanding. Unfinished top and back.</p> | H10504 | 85 | 8.2 | \$728 |
|  | <p>Access Strip (Filler) 1$\frac{1}{8}$"W x 20$\frac{1}{2}$"D x 28"H</p> <p>NOTES: For use with B/B/F, F/F, and or P/M/F pedestals are configured side-by-side. Not required when pedestals are used in conjunction with lateral file pedestal, multi file pedestal or cabinet pedestal. Not for use under 20"D shells.</p> <p>⚠ All 10700 Series™ grommets on desk, credenza, credenza shell, return, return shell, bridge and corner unit worksurfaces changed from rectangle-shaped to round, effective November, 2011.</p> | H10524 | 21 | 0.9 | \$187 |

NOTES:

- Pedestals can be reconfigured quickly and easily when user preferences or space needs change.
- Pedestal models ship assembled unless designated ⚠.
- Locking units equipped with interchangeable core removable locks.
- See pages 336-339 for modular desk, credenza and return shells.

⚠ Keyed alike cores must be ordered separately — see page 773.

⚠ Pedestals are not designed to be used freestanding. Unfinished top and back.

⚠ Access strip (filler) required when full height pedestals are configured side-by-side to allow access for opening the drawers.

HOW TO SPECIFY

Select Model Number

H 1 0 5 0 1

Select Laminate

See page 329

N

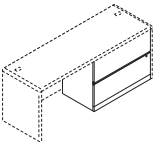
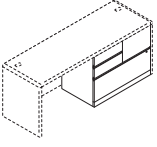
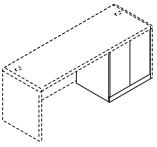
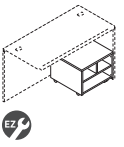

10700 SERIES™ Laminate Modular Components

| | DESCRIPTION | MODEL | SHIP WEIGHT | CUBE | LIST PRICE |
|--|--|----------------|-------------|------|---------------|
|  | <p>Lateral File Pedestal (with core removable lock) – floor-standing 36"W x 20"D x 28"H — for use under 24"D, 30"D and 36"D desk, credenza and return shells</p> <p>NOTES: Designed for use with credenza or return shells. Hangrails included. Mechanical interlock inhibits extension of more than one drawer at a time. Not for use under 20"D shells.</p> <p>⚠ Not designed to be used freestanding. Unfinished top and back.</p> | H10503 | 127 | 15.6 | \$1105 |
|  | <p>Multi File Pedestal (with core removable lock) – floor-standing 36"W x 20"D x 28"H — for use under 24"D, 30"D and 36"D desk, credenza and return shells</p> <p>NOTES: Designed for use with credenza or return shells. Versatile four drawer unit features one lateral file drawer, one vertical file drawer, and two box drawers. Box drawers do not lock. Hangrails included. Mechanical interlock in lateral drawer inhibits extension of more than one drawer at a time. Not for use under 20"D shells.</p> <p>⚠ Not designed to be used freestanding. Unfinished top and back.</p> | H10505 | 155 | 15.6 | \$1324 |
|  | <p>Cabinet Pedestal – floor-standing 26"W x 21¼"D x 28"H — for use under 24"D, 30"D and 36"D desk, credenza and return shells</p> <p>NOTES: One adjustable shelf at 2½" increments. For use with credenza or return shells. Doors are non-locking. Not for use under 20"D shells.</p> <p>⚠ Not designed to be used freestanding. Unfinished top and back.</p> | H10508 | 78 | 12.2 | \$824 |
|  | <p>Mobile Printer/Fax Cart 20"W x 19⅞"D x 14⅞"H</p> <p>NOTES: Holds laser printers, inkjet printers or fax machines. Ideal for limited space. Low profile cart stores conveniently and easily under desks and workstations. Interior compartment shelving is Black. Four casters. Not for use under 20"D shells. Flat edge profile on top.</p> <p>SPECIFYING EXAMPLE: H105679.NN</p> <p>⚠ All 10700 Series™ grommets on desk, credenza, credenza shell, return, return shell, bridge and corner unit worksurfaces changed from rectangle-shaped to round, effective November, 2011.</p> | H105679 | 52 | 2.9 | \$451 |

NOTES:

- Pedestals can be reconfigured quickly and easily when user preferences or space needs change.
- Locking units equipped with interchangeable core removable locks.
- See pages 336-339 for modular desk, credenza and return shells.
- ⚠ Keyed alike cores must be ordered separately — see HF23B on page 773.
- ⚠ Pedestals are not designed to be used freestanding. Unfinished top and back.
- ⚠ Access strip (filler) required when full height pedestals are configured side-by-side to allow access for opening the drawers.

HOW TO SPECIFY

| | |
|---|--|
| Select Model Number <input type="text" value="H10503"/> | Select Laminate See page 329 <input type="text" value="N"/> |
|---|--|

10700 SERIES™

Laminate Wood Desks — Full Pedestals

GSA SIN 33721



Icon Legend on page 19

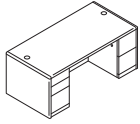

| DESCRIPTION | RECESSED MODESTY PANEL | MODEL | SHIP WEIGHT | CUBE | LIST PRICE |
|--|---------------------------|---------------|----------------|------|---------------|
| Double Pedestal Desk w/Woodgrain Breakfront Modesty Panel — 3/2 | | | | | |
| 72"W x 36"D x 29½"H | 10½" | H10799 | 371 | 52.9 | \$2398 |
| 66"W x 30"D x 29½"H | 4½" | H10774 | 313 | 40.9 | \$2314 |
| 60"W x 30"D x 29½"H | 4½" | H10773 | 305 | 37.3 | \$2202 |
| NOTES: All drawers lock. Two worksurface grommets to route/hide cords. See page 356 for optional center drawers. | | | | | |

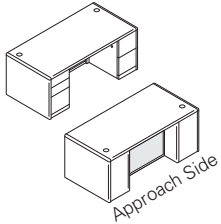

| | | | | | |
|--|------|----------------|-----|------|---------------|
| Double Pedestal Desk w/Frosted Breakfront Modesty Panel — 3/2 | | | | | |
| 72"W x 36"D x 29½"H | 10½" | H10799G | 366 | 51.8 | \$2940 |
| NOTES: All drawers lock. Two worksurface grommets to route/hide cords. See page 356 for optional center drawers. | | | | | |

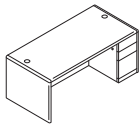

| | | | | | |
|--|------|----------------|-----|------|---------------|
| Single Pedestal Desk w/Woodgrain Breakfront Modesty Panel — Box/box/file | | | | | |
| 72"W x 36"D x 29½"H, Right | 10½" | H10787R | 317 | 52.9 | \$2071 |
| 66"W x 30"D x 29½"H, Right | 4½" | H10701R | 270 | 40.9 | \$1904 |
| 72"W x 36"D x 29½"H, Left | 10½" | H10788L | 317 | 52.9 | \$2071 |
| 66"W x 30"D x 29½"H, Left | 4½" | H10702L | 270 | 40.9 | \$1904 |
| NOTES: Drawers lock. Two worksurface grommets to route/hide cords. See page 356 for optional center drawers. | | | | | |

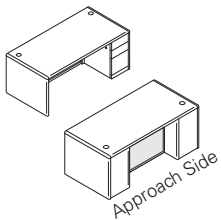

| | | | | | |
|--|------|-----------------|-----|------|---------------|
| Single Pedestal Desk w/Frosted Breakfront Modesty Panel — Box/box/file | | | | | |
| 72"W x 36"D x 29½"H, Right | 10½" | H10787RG | 313 | 51.8 | \$2611 |
| 72"W x 36"D x 29½"H, Left | 10½" | H10788LG | 313 | 51.8 | \$2611 |
| NOTES: Drawers lock. Two worksurface grommets to route/hide cords. See page 356 for optional center drawers. | | | | | |

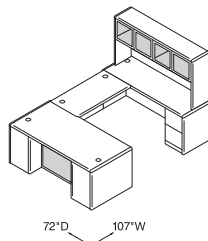

H10788L
H10770
H10707R
H10734G

! All 10700 Series™ grommets on desk, credenza, credenza shell, return, return shell, bridge and corner unit worksurfaces changed from rectangle-shaped to round, effective November, 2011.

NOTES:

- Worksurfaces and end panels feature contract-grade scratch, stain and spill resistant high-pressure laminate over durable 1/8" solid core high-performance particleboard.
- Contoured hardwood trim; stained to match laminate.
- User friendly waterfall-shaped edges.
- Full-to-floor pedestals maximize storage space.
- Breakfront modesty panel design on full height pedestal desks. See approach side illustration above.
- Grommet can be replaced with optional Power Hub or Power/USB Hub for easy plug-and-play. See page 358.
- All drawers are 5-sided construction, which allows easy drawer alignment or replacement of drawer fronts.
- File drawer design includes integrated hangrails for side-to-side letter or legal filing; and front-to-back for letter filing.
- Adjustable hex leveling glides allow floor-standing furniture to be easily leveled without lifting the unit; glides have 3/4" adjustable range.
- Desk, credenza, and return models ship assembled; ready to set in place.
- See pages 346-358 for shared components.

HOW TO SPECIFY

| | |
|---|---|
| <p>Select Model Number</p> <p>H 1 0 7 9 9 .</p> | <p>Select Laminate</p> <p>See page 329</p> <p>N N</p> |
|---|---|



10700 SERIES™

Laminate Wood Desks — Full Pedestals

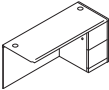
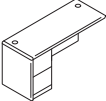
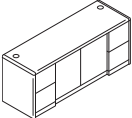
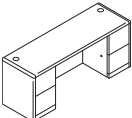
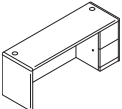
| | DESCRIPTION | RECESSED MODESTY PANEL | MODEL | SHIP WEIGHT | CUBE | LIST PRICE |
|---|--|---------------------------|-----------------|----------------|------|---------------|
|  | Return — Right file/file (2 grommets) | | | | | |
| | 60"W x 24"D x 29½"H | | H10709R | 176 | 29.7 | \$1471 |
| | 48"W x 24"D x 29½"H | | H10711R | 158 | 24.9 | \$1274 |
| | 42"W x 24"D x 29½"H | | H107191R | 150 | 22.1 | \$1259 |
| | NOTES: Drawers lock. Two worksurface grommets to route/hide cords and one cord pass-through grommet in top center of modesty panel. See pages 348-349 for optional stack-on storage. | | | | | |
| | ⚠ Not designed to be used freestanding. | | | | | |
|  | Return — Left file/file (2 grommets) | | | | | |
| | 60"W x 24"D x 29½"H | | H10710L | 176 | 29.7 | \$1471 |
| | 48"W x 24"D x 29½"H | | H10712L | 158 | 24.9 | \$1274 |
| | 42"W x 24"D x 29½"H | | H107192L | 150 | 22.1 | \$1259 |
| | NOTES: Drawers lock. Two worksurface grommets to route/hide cords and one cord pass-through grommet in top center of modesty panel. See pages 348-349 for optional stack-on storage. | | | | | |
| | ⚠ Not designed to be used freestanding. | | | | | |
|  | Credenza with Doors | | | | | |
| | 72"W x 24"D x 29½"H | 3½" | H10742 | 314 | 36.0 | \$2398 |
| | NOTES: All drawers lock. Doors are non-locking. Two worksurface grommets to route/hide cords and one pass-through grommet in top center of modesty panel. Includes a fixed shelf located at the bottom of the center storage area. No intermittent shelf. See pages 348-349 for optional stack-on storage. | | | | | |
|  | Credenza with Kneespace — 2/0/2 | | | | | |
| | 72"W x 24"D x 29½"H | 3½" | H10741 | 280 | 36.0 | \$2071 |
| | 66"W x 24"D x 29½"H | 3½" | H10768 | 270 | 33.4 | \$1947 |
| | 60"W x 24"D x 29½"H | 3½" | H10767 | 241 | 28.8 | \$1893 |
| | NOTES: All drawers lock. Two worksurface grommets to route/hide cords and one pass-through grommet in top center of modesty panel. See pages 348-349 for optional stack-on storage. | | | | | |
| | ⚠ Not designed to be used with 22¾"D modular or mobile pedestals. Modesty/back panel is inset 3½". | | | | | |
|  | Single Pedestal Credenza, File/File | | | | | |
| | 72"W x 24"D x 29½"H, Right | 3½" | H10707R | 235 | 36.3 | \$1695 |
| | 66"W x 24"D x 29½"H, Right | 3½" | H10705R | 225 | 33.4 | \$1665 |
| | 72"W x 24"D x 29½"H, Left | 3½" | H10708L | 235 | 36.3 | \$1695 |
| | 66"W x 24"D x 29½"H, Left | 3½" | H10706L | 225 | 33.4 | \$1665 |
| | NOTES: Drawers lock. Two worksurface grommets to route/hide cords and one cord pass-through grommet in top center of modesty panel. See pages 348-349 for optional stack-on storage. | | | | | |
| | ⚠ Not designed to be used with 22¾"D modular or mobile pedestals. Modesty/back panel is inset 3½". | | | | | |
| | ⚠ All 10700 Series™ grommets on desk, credenza, credenza shell, return, return shell, bridge and corner unit worksurfaces changed from rectangle-shaped to round, effective November, 2011. | | | | | |

NOTES:

- Worksurfaces and end panels feature contract-grade scratch, stain and spill resistant high-pressure laminate over durable 1/8" solid core high-performance particleboard.
- Contoured hardwood trim; stained to match laminate.
- User friendly waterfall-shaped edges.
- Full-to-floor pedestals maximize storage space.
- Breakfront modesty panel design on full height pedestal desks. See approach side illustration on page 342.
- Cord management grommets serve as anchor points for stack-on storage and organizers.
- All drawers are 5-sided construction, which allows easy drawer alignment or replacement of drawer fronts.
- File drawer design includes integrated hangrails for side-to-side letter or legal filing; and front-to-back for letter filing.
- Adjustable hex leveling glides allow floor-standing furniture to be easily leveled without lifting the unit; glides have 3/4" adjustable range.
- Desk, credenza, and return models ship assembled; ready to set in place.
- For work-in-process paper management tools, see page 355.
- See pages 346-358 for shared components.

HOW TO SPECIFY

| | |
|----------------------------|------------------------|
| Select Model Number | Select Laminate |
| H 1 0 7 0 9 R . | See page 329 N N |

10700 SERIES™

Laminate Wood Desks — 3/4 Pedestals

GSA SIN 33721

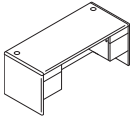
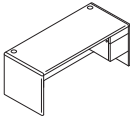
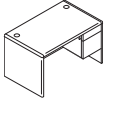
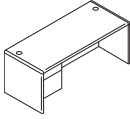
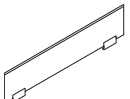

Icon Legend on page 19

| | DESCRIPTION | FULL WIDTH OVERHANG | MODEL | SHIP WEIGHT | CUBE | LIST PRICE |
|--|---|---------------------|-----------------|-------------|------|---------------|
|  | Double Pedestal Desk, 2-2 | | | | | |
| | 72"W x 36"D x 29½"H | 10½" | H10791 | 340 | 52.9 | \$1873 |
| | 66"W x 30"D x 29½"H | 4½" | H10775 | 290 | 40.9 | \$1789 |
| | 60"W x 30"D x 29½"H | 4½" | H10771 | 266 | 37.4 | \$1576 |
| | NOTES: All drawers lock. Two worksurface grommets to route/hide cords. See page 356 for optional center drawers. | | | | | |
|  | Single Pedestal Desk, Right box/file | | | | | |
| | 72"W x 36"D x 29½"H | 10½" | H10785R | 279 | 52.9 | \$1552 |
| | 66"W x 30"D x 29½"H | 4½" | H10783R | 239 | 41.0 | \$1415 |
| | NOTES: Drawers lock. Two worksurface grommets to route/hide cords. See page 356 for optional center drawers. | | | | | |
|  | Small Office Desk, 3/4 Pedestal, Right box/file | | | | | |
| | 48"W x 30"D x 29½"H | | H107885R | 191 | 30.2 | \$1299 |
| | NOTES: Footprint is ideal for limited space. Drawers lock. Two cord management grommets in the top. 3/4 height modesty panel facilitates reaching wall electrical outlets. Optional stack-on storage model H107313 maximizes storage space. See page 356 for optional center drawers. | | | | | |
|  | Single Pedestal Desk, Left box/file | | | | | |
| | 72"W x 36"D x 29½"H | 10½" | H10786L | 279 | 52.9 | \$1552 |
| | 66"W x 30"D x 29½"H | 4½" | H10784L | 239 | 41.0 | \$1415 |
| | NOTES: Drawers lock. Two worksurface grommets to route/hide cords. See page 356 for optional center drawers. | | | | | |
| <p>! All 10700 Series™ grommets on desk, credenza, credenza shell, return, return shell, bridge and corner unit worksurfaces changed from rectangle-shaped to round, effective November, 2011.</p> | | | | | | |
|  | Above Privacy Screen | | | | | |
| | 60"W x 13"H | | HLSL1260 | 24 | 2.9 | \$508 |
| | 54"W x 13"H | | HLSL1254 | 22 | 2.9 | \$473 |
| | 48"W x 13"H | | HLSL1248 | 20 | 2.3 | \$443 |
| | 42"W x 13"H | | HLSL1242 | 18 | 2.3 | \$387 |
| | 36"W x 13"H | | HLSL1236 | 15 | 1.8 | \$345 |
| | 30"W x 13"H | | HLSL1230 | 13 | 1.5 | \$313 |
| | NOTES: Ships complete with attachment bracket. Bracket is Platinum only, no need to specify. Attaches to top of rectangle worksurfaces; requires a minimum overhang of 1½". | | | | | |
| | ! Available in Frosted Glass ONLY HLSL1230.G. | | | | | |
| | ! Above only Privacy Screen clamps onto worksurface and cannot be installed where support storage will be attached. | | | | | |

NOTES:

- Worksurfaces and end panels feature contract-grade scratch, stain and spill resistant high-pressure laminate over durable 1½" solid core high-performance particleboard.
- Contoured hardwood trim; stained to match laminate.
- User friendly waterfall-shaped edges and rounded corners.
- 3/4 pedestal design increases budget flexibility.
- Formal, full height modesty panels.
- Drawers operate on full extension, ball-bearing suspensions to ensure smooth, quiet, long-lasting operation.
- All drawers are 5-sided construction, which allows easy drawer alignment or replacement of drawer fronts.
- File drawer design includes integrated hangrails for side-to-side letter or legal filing; and front-to-back for letter filing.
- Grommet can be replaced with optional Power Hub or Power/USB Hub for easy plug-and-play. See page 358.
- Adjustable hex leveling glides allow floor-standing furniture to be easily leveled without lifting the unit; glides have ¾" adjustable range.
- Desk, credenza, and return models ship assembled; ready to set in place.
- Center drawers conveniently store writing instruments, paper and other miscellaneous items. Includes pencil tray. See page 356.
- See pages 346-358 for shared components.

HOW TO SPECIFY

| | |
|----------------------------|------------------------|
| Select Model Number | Select Laminate |
| | See page 329 |
| H 1 0 7 9 1 . | N N |



10700 SERIES™

Laminate Wood Desks — 3/4 Pedestals

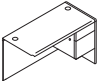
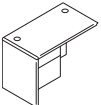
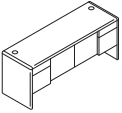
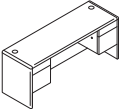
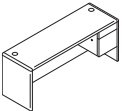
| | DESCRIPTION | FULL WIDTH OVERHANG | MODEL | SHIP WEIGHT | CUBE | LIST PRICE |
|--|---|---------------------|-----------------|-------------|------|---------------|
|  <p>Model H10717R shown</p> | Return — Right box/file (2 grommets) | | | | | |
| | 60"W x 24"D x 29½"H | | H10717R | 173 | 29.7 | \$1183 |
| | 48"W x 24"D x 29½"H | | H10715R | 147 | 25.3 | \$1044 |
| | 42"W x 24"D x 29½"H | | H107193R | 136 | 22.1 | \$1017 |
| | NOTES: Drawers lock. Two worksurface grommets and one cord pass-through grommet in top center of modesty panel. See pages 348-349 for optional stack-on storage. | | | | | |
| | ⚠ Not designed to be used freestanding. | | | | | |
|  <p>Model H10716L shown</p> | Return — Left box/file (2 grommets) | | | | | |
| | 60"W x 24"D x 29½"H | | H10718L | 173 | 29.7 | \$1183 |
| | 48"W x 24"D x 29½"H | | H10716L | 147 | 25.3 | \$1044 |
| | 42"W x 24"D x 29½"H | | H107194L | 136 | 22.1 | \$1017 |
| | NOTES: Drawers lock. Two worksurface grommets and one cord pass-through grommet in top center of modesty panel to reach wall electrical outlets. See pages 348-349 for optional stack-on storage. | | | | | |
| | ⚠ Not designed to be used freestanding. | | | | | |
|  | Credenza with Doors | 3½" | H10744 | 278 | 36.0 | \$1888 |
| | 72"W x 24"D x 29½"H | | | | | |
| | NOTES: All drawers lock. Hinged doors are non-locking. Two worksurface grommets and one cord pass-through grommet in top center of modesty panel to reach wall electrical outlets. Includes a fixed shelf located at the bottom of the center storage area. No intermittent shelf. See pages 348-349 for optional stack-on storage. | | | | | |
|  | Credenza with Kneespace | | | | | |
| | 72"W x 24"D x 29½"H | 3½" | H10743 | 243 | 36.3 | \$1684 |
| | 66"W x 24"D x 29½"H | 3½" | H10766 | 234 | 33.4 | \$1574 |
| | 60"W x 24"D x 29½"H | 3½" | H10765 | 229 | 28.8 | \$1503 |
| | NOTES: Drawers lock. Two worksurface grommets and one cord pass-through grommet in top center of modesty panel to reach wall electrical outlets. See pages 348-349 for optional stack-on storage. | | | | | |
| | ⚠ Not designed to be used with 22¾"D modular or mobile pedestals. Modesty/back panel is inset 3½". | | | | | |
|  | Single Pedestal Credenza, Box/File | | | | | |
| | 72"W x 24"D x 29½"H, Right | 3½" | H10745R | 212 | 36.0 | \$1361 |
| | 66"W x 24"D x 29½"H, Right | 3½" | H10763R | 203 | 33.4 | \$1339 |
| | 72"W x 24"D x 29½"H, Left | 3½" | H10746L | 212 | 36.0 | \$1361 |
| | 66"W x 24"D x 29½"H, Left | 3½" | H10764L | 203 | 33.4 | \$1339 |
| | NOTES: Drawers lock. Two worksurface grommets and one cord pass-through grommet in top center of modesty panel to reach wall electrical outlets. See pages 348-349 for optional stack-on storage. | | | | | |
| | ⚠ Not designed to be used with 22¾"D modular or mobile pedestals. Modesty/back panel is inset 3½". | | | | | |
| | ⚠ All 10700 Series™ grommets on desk, credenza, credenza shell, return, return shell, bridge and corner unit worksurfaces changed from rectangle-shaped to round, effective November, 2011. | | | | | |

NOTES:

- Worksurfaces and end panels feature contract-grade scratch, stain and spill resistant high-pressure laminate over durable 1½" solid core high-performance particleboard.
- Contoured hardwood trim; stained to match laminate.
- User friendly waterfall-shaped edges and rounded corners.
- 3/4 pedestal design increases budget flexibility.
- Formal, full height modesty panels.
- Cord management grommets also serve as anchor points for stack-on storage and organizers.
- All drawers are 5-sided construction, which allows easy drawer alignment or replacement of drawer fronts.
- File drawer design includes integrated hangrails for side-to-side letter or legal filing; and front-to-back for letter filing.
- Adjustable hex leveling glides allow floor-standing furniture to be easily leveled without lifting the unit; glides have ¾" adjustable range.
- Desk, credenza, and return models ship assembled; ready to set in place.
- For work-in-process paper management tools, see page 355.
- See pages 346-358 for shared components.

HOW TO SPECIFY

| | |
|----------------------------|------------------------|
| Select Model Number | Select Laminate |
| See page 329 | See page 329 |
| H 1 0 7 4 5 R . | N N |

10700 SERIES™

Shared Components and Accessories

GSA SIN 33721

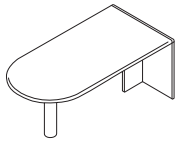

Icon Legend on page 19

**DESCRIPTION****Peninsula w/End Panel and Steel Support Column**

72"W x 36"D x 29½"H
66"W x 30"D x 29½"H

MODEL

H10721E
H10722E

SHIP WEIGHT

146
121

CUBE

8.1
8.1

LIST PRICE

\$1529
\$1336

NOTES: Use for "U" or "L" configuration. Cord routing notch in brace panel. Round support column is black. For a silver support column option, please see model HPC191X on page 281 (ordered separately).

⚠ Not designed to be used freestanding.

**Field Installable Laminate Modesty Panel**

50¼"W x ¾"Thick x 18"H

H10528

25

1.3

\$203

NOTES: Center drawer model H1522 can be used in conjunction with modesty panel. Cord pass-through notch in top corner of modesty panel. See page 356 for optional center drawers.

⚠ Not designed to attach to peninsulas manufactured prior to 12/1/2001.

SPECIFYING EXAMPLE: H10528.N

**Field Installable Modesty Panel, Frosted with Silver Frame**

50¼"W x ¾"Thick x 18"H — for use on 72"W peninsulas

HPC180G

33 Ⓢ

1.5

\$745

⚠ Center drawers not designed to be used with the frosted/silver modesty panel.

NOTES:

- Shared components on this page can be used with modular, full pedestal, and 3/4 pedestal models shown on pages 336-345.
- Multi file is a versatile four drawer unit featuring two box drawers, one file drawer, and one lateral file drawer with mechanical interlock.
- Cord management grommets, for routing and hiding wires and cables, are located in the tops of desks, credenzas, and returns. Grommets also serve as anchor points for stack-on storage and organizers.
- Cord pass-through grommet located in the back/modesty panel of returns, bridges and credenzas, facilitates reaching wall electrical outlets.
- All drawers are 5-sided construction, which allows easy drawer alignment or replacement of drawer fronts.
- Locking units equipped with interchangeable core removable locks.
- Stack-on storage attaches with two removable mounting brackets.
- Adjustable hex leveling glides allow floor-standing furniture to be easily leveled without lifting the unit; glides have ¾" adjustable range.
- See pages 346-358 for shared components.

⚠ Keyed alike cores must be ordered separately — see page 773.

HOW TO SPECIFY**Select Model Number**

H 1 0 7 2 1 E .

Select Laminate

See page 329

N N .

Select Paint Color

Specify for new peninsula models only

P Black

P



10700 SERIES™

Shared Components and Accessories

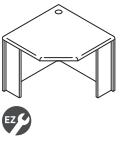
| DESCRIPTION | MODEL | SHIP WEIGHT | CUBE | LIST PRICE |
|---|---------|-------------|------|------------|
|  <p>Corner Unit 24" x 36" x 36" x 24" x 29½"H – (1 grommet in top) Works with 24"D x 29½"H returns or bridges.</p> <p>NOTES: The corner unit has rounded, solid wood trim on the front and back. Return and bridge connections are inset inside the wood profiles, per the drawing shown. Support legs feature cutouts for routing cords. Can be used freestanding.</p> | H107811 | 136 | 4.2 | \$1381 |

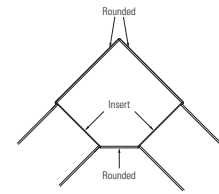
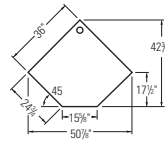

| DESCRIPTION | FULL WIDTH OVERHANG | MODEL | SHIP WEIGHT | CUBE | LIST PRICE |
|---|---------------------|--|----------------------------|---------------------------------|---|
|  <p>Bridge (Single Ped. Desk, Desk Shell or Peninsula to Corner Unit or Single Ped. Credenza or Credenza Shell) 47"W x 24"D x 29½"H, (Clear inside depth = 22¾"D) 42"W x 24"D x 29½"H, (Clear inside depth = 22¾"D) 36"W x 24"D x 29½"H, (Clear inside depth = 22¾"D) (for use with Corner Units) 47"W x 20"D x 29½"H, (Clear inside depth = 18¾"D) 42"W x 20"D x 29½"H, (Clear inside depth = 18¾"D)</p> <p>NOTES: Two cord grommets in top; one cord pass-through grommet in top center of modesty panel. Grommets can be replaced with optional Power Hub or Power/USB Hub for easy plug-and-play (see page 358). Kneespace of desk limited to 24¾"W if bridge is used with 66"W single pedestal desk.</p> | | H10770 H10760 H10751 H107399 H107398 | 81 69 64 68 56 | 2.5 2.6 2.5 2.8 2.6 | \$472 \$455 \$452 \$455 \$440 |

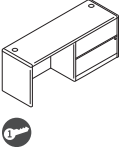
| | | | | |
|--|--------------------|------------|--------------|------------------|
|  <p>Credenza with 36" Lateral (with core removable lock) – 2 cord grommets in top 72"W x 24"D x 29½"H, Right 3½" 72"W x 24"D x 29½"H, Left 3½"</p> <p>NOTES: One cord pass-through grommet in top center of modesty panel. Mechanical interlock inhibits the extension of more than one drawer at a time. Optional stack-on models H10734, H10734K, and H10734G maximize storage space.</p> <p>⚠ Not designed to be used with 22¾"D modular or mobile pedestals. Modesty/back panel is inset 3½".</p> | H10747R H10748L | 247 247 | 36.0 36.0 | \$1874 \$1874 |
|--|--------------------|------------|--------------|------------------|

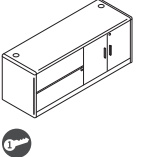
| | | | | |
|---|---------|-----|------|--------|
|  <p>Credenza with Lateral File, Left and Storage Cabinet, Right 72"W x 24"D x 29½"H</p> <p>NOTES: Lateral file is equipped with mechanical interlock to inhibit the extension of more than one drawer at a time. Storage cabinet has one adjustable interior shelf which adjusts in 1¼" increments over a range of 5". Drawers and doors lock separately; the two locks are keyed alike. Can be used with optional stack-on storage. See page 348 for Stack-on Storage models H10734/H10734K/H10734G.</p> | H107492 | 307 | 35.6 | \$2323 |
|---|---------|-----|------|--------|

NOTES:

- Cord management grommets, for routing and hiding wires and cables, are located in the tops of desks, credenzas, and returns. Grommets also serve as anchor points for stack-on storage and organizers.
- Cord pass-through grommet located in the back/modesty panel of returns, bridges and credenzas, facilitates reaching wall electrical outlets.
- All drawers are 5-sided construction, which allows easy drawer alignment or replacement of drawer fronts.
- Locking units equipped with interchangeable core removable locks.
- Stack-on storage attaches with two removable mounting brackets.
- Adjustable hex leveling glides allow floor-standing furniture to be easily leveled without lifting the unit; glides have ¾" adjustable range.
- See pages 346-358 for shared components.

HOW TO SPECIFY

| | |
|---|---|
| Select Model Number <input type="text" value="H10770"/> | Select Laminate See page 329 <input type="text" value="NN"/> |
|---|---|

10700 SERIES™

Shared Components and Accessories

GSA SIN 33721

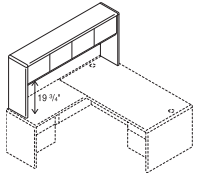

Icon Legend on page 19

**DESCRIPTION****Stack-on Storage for "L" Workstation**

74⁵/₈"W x 14⁵/₈"D x 37¹/₈"H
(Use Task Light model HH870960, see page 357)

MODEL**H107318****SHIP WEIGHT**

198

CUBE

15.8

LIST PRICE**\$1533****Stack-on Storage for "L" Workstation, Locking**

74⁵/₈"W x 14⁵/₈"D x 37¹/₈"H
(Use Task Light model HH870960, see page 357)

H107318K

198

15.8

\$1624

NOTES: Spans the total depth dimension of configurations comprised of: 48"W return or return shell attached to a 30"D single pedestal desk, desk shell or peninsula (78"D); 42"W return or return shell attached to a 36"D single pedestal desk, desk shell or peninsula (78"D) or 42"W return or return shell attached to a 36" corner unit (78"D). Attaches to desk, peninsula, or corner unit via double-sided tape, and to return through grommet hole. Inside storage consists of two compartments each 34³/₄"W x 12¹/₈"D x 12"H. Use back enclosure model H107358 and tackboard model H90035. For vertical paper manager, see page 355.

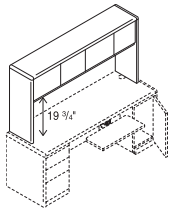
**Stack-on Storage**

68⁵/₈"W x 14⁵/₈"D x 37¹/₈"H, 4 doors (For 72"W Credenza)
62⁵/₈"W x 14⁵/₈"D x 37¹/₈"H, 4 doors (For 66"W Credenza)
56⁵/₈"W x 14⁵/₈"D x 37¹/₈"H, 4 doors (For 60"W Credenza or Return)
44⁵/₈"W x 14⁵/₈"D x 37¹/₈"H, 3 doors (For 48"W Return or 48"W Small Office Desk)

H10734

175

16.0

\$1396**H10733**

168

14.4

\$1380**H10732**

161

13.0

\$1339**H107313**

147

10.3

\$1231**Stack-on Storage, Locking**

68⁵/₈"W x 14⁵/₈"D x 37¹/₈"H, 4 doors (For 72"W Credenza)
62⁵/₈"W x 14⁵/₈"D x 37¹/₈"H, 4 doors (For 66"W Credenza)
56⁵/₈"W x 14⁵/₈"D x 37¹/₈"H, 4 doors (For 60"W Credenza or Return)
44⁵/₈"W x 14⁵/₈"D x 37¹/₈"H, 3 doors (For 48"W Return or 48"W Small Office Desk)

H10734K

175

16.0

\$1487**H10733K**

168

14.4

\$1471**H10732K**

161

13.0

\$1431**H107313K**

147

10.3

\$1299

NOTES: Inside storage for H10734, H10733 and H10732 contains two compartments each sized: 32¹/₂"W, 28³/₄"W, 25³/₄"W respectively x 12¹/₈"D x 12"H. H107313 has 3 doors. Inside storage for H107313 contains two compartments: right side 12¹/₈"W, left side 26³/₄"W respectively x 12¹/₈"D x 12"H. Stack-ons attach through grommet holes on the worksurfaces of desks, credenzas and returns. Model 10734 can be used for "L" configuration comprised of 30"D desk, desk shell or peninsula and 42"W return or return shell; or a 36"D desk, desk shell, peninsula or corner unit and 36"W return shell. Model H107313K has one lock which secures two of the three doors. For task light and vertical paper manager, see pages 355 and 357.

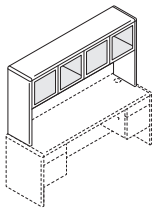
**Stack-on Storage w/Frosted Doors w/Silver Frame**

68⁵/₈"W x 14⁵/₈"D x 37¹/₈"H

H10734G

185

16.2

\$2097

NOTES: Rich woodgrain laminate and contemporary frosted doors with silver frames add a sleek mixed materials option to 10700 Series™. Accepts back enclosure model H10738, tackboard for use with back enclosure model H90034, task light HH870960 and vertical paper manager HVLPM1. Frosted door models are non-locking.

NOTES:

- Shared components on this page can be used with modular, full pedestal, and 3/4 pedestal models shown on pages 336-345.
- Stack-on storage models are equipped with self closing, adjustable hinged doors, and valance to hide task light.
- When spanning the total depth of an L-workstation, stack-on storage attaches to the desk, peninsula or corner unit via double-sided tape, and to the return through the grommet hole.
- Stack-on storage end panels are .
- Stack-on storage and organizers attach with two removable mounting brackets, except for "L" workstation unit.
- Stacked paper management segments and organizes stack-on storage compartments and bookcase shelves. Unit can be used in stack-on storage models H107318 and H10734. See HLVPM2 on page 355.
- Vertical paper manager keeps papers, files, and books neatly organized and within easy reach from a seated position. Fits under stack-on storage models. See page 355.
- See pages 346-358 for shared components.

 Upcharges may apply to premium tackboard fabric grades.

 Removable lock core kit for locking stack-on storage is model HF27B. See page 773.

HOW TO SPECIFY

Select
Model Number

H 1 0 7 3 4 .

Select
Laminate

See page 329

N N



10700 SERIES™

Shared Components and Accessories

| | DESCRIPTION | MODEL | COM | SHIP WEIGHT | CUBE | LIST PRICE |
|--------------|--|----------------|-----|-------------|------|--------------|
| 18 5/8"H | Back Enclosure for Stack-on Storage | | | | | |
| | 72 1/4"W - for 74 5/8"W model #H107318/H107318K | H107358 | | 34 | 1.3 | \$303 |
| | 66 1/4"W - for 68 5/8"W model #H10734/H10734K | H10738 | | 31 | 1.3 | \$279 |
| | 60 1/4"W - for 62 5/8"W model #H10733/H10733K | H10737 | | 29 | 1.3 | \$259 |
| | 54 1/4"W - for 56 5/8"W model #H10732/H10732K | H10736 | | 27 | 1.3 | \$248 |
| | 42 1/4"W - for 44 5/8"W model #H107313/H107313K | H107353 | | 22 | 0.9 | \$248 |
| | NOTES: Non-tackable. Specify laminate. Features full width 1 1/8" slot at bottom to facilitate routing cords and reaching wall electrical outlets. H10738 can also be used with H10634 and H94234 stack-ons. | | | | | |
| 18"H | Tackboards for use with Stack-on Back Enclosures (Back Enclosures must be ordered separately.) | | | | | |
| | 71 1/2"W - for 74 5/8"W model #H107318/H107318K Hutch with #H107358 Enclosure | H90035 | 2.0 | 13 | 2.8 | \$353 |
| | 65 1/4"W - for 68 5/8"W model #H10734/H10734K Hutch with #H10738 Enclosure | H90034 | 2.0 | 11 | 2.0 | \$337 |
| | 59 1/4"W - for 62 5/8"W model #H10733/H10733K Hutch with #H10737 Enclosure | H90033 | 2.0 | 10 | 1.8 | \$321 |
| | 53 1/4"W - for 56 5/8"W model #H10732/H10732K Hutch with #H10736 Enclosure | H90032 | 2.0 | 9 | 1.8 | \$281 |
| | 41 1/2"W - for 44 5/8"W model #H107313/H107313K Hutch with #H107353 Enclosure | H90031 | 2.0 | 7 | 1.7 | \$270 |
| | NOTES: Tackboards are sized 3/4" narrower than respective stack-on storage back enclosure, allowing 3/8" each side to route task light cords. Specify fabric selection from pages 25-26. Board is attached using latch & hook tape provided. H90034 can also be used with H10738 on H10634 and H94234 stack-ons. | | | | | |
| | <p>ⓘ Disperse (DISP) fabric not available on sizes wider than 60".</p> <p>SPECIFYING EXAMPLE: H90035.APN15</p> | | | | | |

NOTES:

- Shared components on this page can be used with modular, full pedestal, and 3/4 pedestal models shown on pages 336-345.
- Stacked paper management segments and organizes stack-on storage compartments and bookcase shelves. Unit can be used in stack-on storage models H107318 and H10734. See HLVPM2 on page 355.
- Vertical paper manager keeps papers, files, and books neatly organized and within easy reach from a seated position. Fits under stack-on storage models. See page 355.
- See pages 346-358 for shared components.

ⓘ Upcharges may apply to premium tackboard fabric grades.

HOW TO SPECIFY

| | |
|--|--|
| Select Model Number <div style="display: flex; gap: 5px;"> <div style="border: 1px solid #ccc; padding: 2px 5px;">H</div> <div style="border: 1px solid #ccc; padding: 2px 5px;">1</div> <div style="border: 1px solid #ccc; padding: 2px 5px;">0</div> <div style="border: 1px solid #ccc; padding: 2px 5px;">7</div> <div style="border: 1px solid #ccc; padding: 2px 5px;">3</div> <div style="border: 1px solid #ccc; padding: 2px 5px;">5</div> <div style="border: 1px solid #ccc; padding: 2px 5px;">8</div> </div> | Select Laminate See page 329 <div style="border: 1px solid #ccc; padding: 2px 5px;">N</div> |
|--|--|





10700 SERIES™

Shared Components and Accessories

GSA SIN 33721

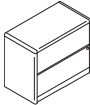
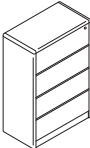
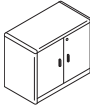
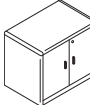
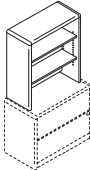

Icon Legend on page 19

| | DESCRIPTION | MODEL | SHIP WEIGHT | CUBE | LIST PRICE |
|---|--|----------------|-------------|------|---------------|
|  | Box/Box/File Mobile Pedestal (with core removable lock) 15 ³ / ₄ "W x 22 ³ / ₄ "D x 28 ⁵ / ₈ "H — use freestanding or under 24"D, 30"D and 36"D modular shells NOTES: Top box drawer does not lock. File drawer includes hangrails. | H105102 | 121 | 8.5 | \$906 |
|  | File/File Mobile Pedestal (with core removable lock) 15 ³ / ₄ "W x 22 ³ / ₄ "D x 28 ⁵ / ₈ "H — use freestanding or under 24"D, 30"D and 36"D modular shells NOTES: File drawers include hangrails. | H105104 | 121 | 8.4 | \$906 |
|  | Box/File Mobile Pedestal (with core removable lock) 15 ³ / ₄ "W x 18 ¹ / ₈ "D x 21 ¹ / ₈ "H — use freestanding or under 20"D, 24"D, 30"D and 36"D modular shells | H105106 | 65 | 5.8 | \$757 |
|  <i>Mobile pedestals have smooth, flat edges.</i> | Shelf/Box/File Mobile Pedestal (with core removable lock) 15 ³ / ₄ "W x 18 ¹ / ₈ "D x 28 ⁵ / ₈ "H — use freestanding or under 20"D, 24"D, 30"D and 36"D modular shells NOTES: Interior dimensions of the open storage area of the Shelf/Box/File model are 14 ¹ / ₈ "W x 16 ³ / ₄ "D x 6 ⁵ / ₈ "H. | H105109 | 73 | 7.3 | \$834 |
|  | Lateral File (with core removable lock) 36"W x 24"D x 29 ¹ / ₂ "H — two drawer — matches depth of credenzas and returns 36"W x 20"D x 29 ¹ / ₂ "H — two drawer 36"W x 20"D x 45 ¹ / ₂ "H — three drawer 36"W x 20"D x 59 ¹ / ₈ "H — four drawer NOTES: Includes hangrails, mechanical interlock and, in H10762 and H107690, a counterweight. Interlock inhibits the extension of more than one drawer from opening at a time. 24"D size aligns evenly with 24"D credenzas, credenza shells, returns, return shells, and wardrobe/storage cabinets to provide linear layout continuity. | H107690 | 191 | 18.6 | \$1390 |
|  | H10762 168 15.6 \$1339 H107698 240 23.2 \$2061 H107699 296 31.0 \$2841 | | | | |
|  | Storage Cabinet with Doors (with core removable lock) 36"W x 20"D x 29 ¹ / ₂ "H NOTES: One adjustable interior shelf. | H107291 | 144 | 15.0 | \$1084 |
|  | Storage Cabinet with Doors (with core removable lock) 36"W x 24"D x 29 ¹ / ₂ "H — matches depth of credenzas and returns NOTES: One adjustable interior shelf. 24"D size aligns evenly with 24"D credenzas, credenza shells, returns, return shells, and wardrobe/storage cabinets to provide linear layout continuity. | H107290 | 162 | 18.6 | \$1192 |
|  | Bookcase Hutch 32 ⁵ / ₈ "W x 14 ⁵ / ₈ "D x 37 ¹ / ₈ "H NOTES: For use with Lateral Files (H10762, H107690) and Storage Cabinets (H107291, H107290). Cord pass-through gap behind shelves and a 1 ¹ / ₈ " full-width cord management slot at the bottom of the back panel to facilitate routing cords and reaching wall electrical outlets. When placed on a 29 ¹ / ₂ "H base unit, the total 66 ⁵ / ₈ "H matches the height of credenzas with stack-on storage and the height of the wardrobe/storage cabinet. Two shelves are adjustable in 1/4" increments. | H107292 | 93 | 5.1 | \$806 |

NOTES:

- Shared components on this page can be used with modular, full pedestal, and 3/4 pedestal models shown on pages 336-345.
- Broad family of storage components takes organization way beyond the confines of a desk drawer.
- Mobile pedestal tops have smooth, flat edges. Units are standard with counterweight and four 2" diameter, non-locking casters.
- Locking units equipped with interchangeable core removable locks.
- Mobile pedestals, lateral files, storage cabinets, and bookcases ship assembled.
- See pages 346-358 for shared components.

! Keyed alike cores must be ordered separately — see model HF23B on page 773 — makes re-keying quick and easy.

HOW TO SPECIFY

| | |
|----------------------------|------------------------|
| Select Model Number | Select Laminate |
| See page 329 | See page 329 |
| H 1 0 5 1 0 2 . | N N |



10700 SERIES™

Shared Components and Accessories

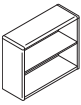
| | DESCRIPTION | MODEL | SHIP WEIGHT | CUBE | LIST PRICE |
|---|---|---------------|-------------|------|---------------|
|  | Bookcase w/Fixed Shelves | | | | |
| | 36"W x 13 ¹ / ₈ "D x 71"H, 5-Shelf | H10755 | 187 | 25.3 | \$1193 |
| | 36"W x 13 ¹ / ₈ "D x 57 ¹ / ₈ "H, 4-Shelf | H10754 | 156 | 20.3 | \$1011 |
| | 36"W x 13 ¹ / ₈ "D x 43 ³ / ₈ "H, 3-Shelf | H10753 | 122 | 15.6 | \$897 |
| | 36"W x 13 ¹ / ₈ "D x 29 ⁵ / ₈ "H, 2-Shelf | H10752 | 90 | 10.9 | \$744 |
| | NOTES: 36"W models with finished back. No assembly required. Ready to set in place. | | | | |

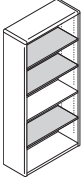
| | | | | | |
|---|--|----------------|-----|------|---------------|
|  | Bookcase w/Adjustable Shelves | | | | |
| | 32 ³ / ₈ "W x 13 ¹ / ₈ "D x 71"H, 5-Shelf | H107569 | 170 | 25.1 | \$1180 |
| | NOTES: 32 ³ / ₈ "W design with five shelves; two fixed, three adjustable. Shelves adjust in 2 ¹ / ₂ " increments. Finished back. | | | | |

Shaded shelves are adjustable.

NOTES:

- Shared components on this page can be used with modular, full pedestal, and 3/4 pedestal models shown on pages 336-345.
- Broad family of storage components takes organization way beyond the confines of a desk drawer.
- Conventional bookcase designs ship fully assembled to ease and speed installation.
- See pages 346-358 for shared components.

HOW TO SPECIFY

| | |
|---|---|
| Select Model Number <div style="display: flex; gap: 5px;"> <div style="border: 1px solid black; padding: 2px 5px;">H</div> <div style="border: 1px solid black; padding: 2px 5px;">1</div> <div style="border: 1px solid black; padding: 2px 5px;">0</div> <div style="border: 1px solid black; padding: 2px 5px;">7</div> <div style="border: 1px solid black; padding: 2px 5px;">5</div> <div style="border: 1px solid black; padding: 2px 5px;">2</div> </div> | Select Laminate See page 329 <div style="display: flex; gap: 5px;"> <div style="border: 1px solid black; padding: 2px 5px;">N</div> <div style="border: 1px solid black; padding: 2px 5px;">N</div> </div> |
|---|---|

10700 SERIES™

Shared Components and Accessories

GSA SIN 33721



Icon Legend on page 19



Doors open 110 degrees from closed position.

| DESCRIPTION | MODEL | SHIP WEIGHT | CUBE | LIST PRICE |
|--|----------------|-------------|------|---------------|
| Storage Cabinet (with core removable lock) 36"W x 24"D x 66 ⁵ / ₈ "H | H107299 | 341 | 41.0 | \$2623 |
| NOTES: Large storage area includes five, full-width (side-to-side) shelves; three are adjustable in 2 ¹ / ₂ " increments. Unit height is designed to match credenza or return plus stack-on height (66 ⁵ / ₈ "). | | | | |

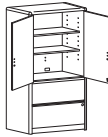

Doors open 110 degrees from closed position.

| | | | | |
|---|----------------|-----|------|---------------|
| Storage Cabinet/Lateral File (with core removable lock) 36"W x 24"D x 66 ⁵ / ₈ "H | H107293 | 365 | 41.0 | \$2882 |
| NOTES: Storage cabinet is standard with one fixed and two full-width adjustable shelves in top compartment; adjustable shelves can be removed. Overall storage compartment measures 31 ¹ / ₄ "W x 22"D x 36 ¹ / ₈ "H and will accommodate supplies, books and binders, as well as business machines and electronic equipment. Cord pass-through gap behind shelves and grommet in back of the cabinet to facilitate routing cords and reaching wall electrical outlets. Two drawer lateral file on bottom. Cabinet and lateral file lock independently. | | | | |

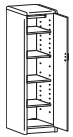

Right-hand model H107295R shown.

| | | | | |
|---|-----------------|-----|------|---------------|
| Wardrobe/Storage Cabinet (with core removable lock) 18"W x 24"D x 66 ⁵ / ₈ "H, with coat rod and 4 adjustable shelves, Hinged Right | H107295R | 225 | 22.9 | \$2121 |
| 18"W x 24"D x 66 ⁵ / ₈ "H, with coat rod and 4 adjustable shelves, Hinged Left | H107296L | 225 | 22.9 | \$2121 |
| NOTES: Unit is standard with four adjustable shelves, coat rod, and core removable lock. Shelves adjust in 2 ¹ / ₂ " increments. Unit height is designed to match credenza or return plus stack-on storage height. Cabinet can be used as a wardrobe by removing four adjustable shelves. Coat rod can be removed from cabinet for storage only applications. | | | | |

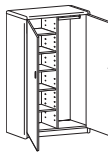

Doors open 110 degrees from closed position.

| | | | | |
|--|---------------|-----|------|---------------|
| Personal Wardrobe/Storage Cabinet (with core removable lock) 36"W x 24"D x 66 ⁵ / ₈ "H | H10730 | 335 | 40.6 | \$2864 |
| NOTES: Spacious design is standard with four adjustable shelves (one shelf is fixed), coat rod and core removable lock which locks both doors. Shelves adjust in 2 ¹ / ₂ " increments. Unit height is designed to match credenza or return plus stack-on storage height. | | | | |



Right-hand model H107301R shown.

| | | | | |
|--|-----------------|-----|------|---------------|
| Personal Storage Towers 24"W x 24"D x 66 ⁵ / ₈ "H, Wardrobe Hinged Right, Storage Cabinet Hinged Left | H107301R | 299 | 27.8 | \$2720 |
| 24"W x 24"D x 66 ⁵ / ₈ "H, Wardrobe Hinged Left, Storage Cabinet Hinged Right | H107302L | 299 | 27.8 | \$2720 |
| NOTES: Spacious design includes a wardrobe closet, storage cabinet, and two file drawers in one compact unit. Wardrobe closet contains a coat rod. Storage cabinet includes three shelves, two are adjustable in 2 ¹ / ₂ " increments. Door hinged left or right models available. File drawers operate on ball-bearing suspensions with full extension. File drawers have high sides to accept hanging folders in letter or legal size. Drawers standard with hangrails. Equipped with interchangeable core removable locks. Upper lock secures storage cabinet and wardrobe closet doors; lower lock secures file drawers. Unit height is designed to match credenza or return plus stack-on storage height. | | | | |

NOTES:

- Broad family of storage components takes storage way beyond the confines of a desk drawer.
- The 18"W wardrobe/storage cabinet can be used as wardrobe by removing some or all of the adjustable shelves, coat rod can be removed for storage only.
- Locking units equipped with interchangeable core removable locks.
- See pages 346-358 for shared components.

! Keyed alike cores must be ordered separately — see model HF23B on page 773 — makes re-keying quick and easy.







HOW TO SPECIFY

| | |
|----------------------------|------------------------|
| Select Model Number | Select Laminate |
| | See page 329 |
| H 1 0 7 2 9 3 . | N N |

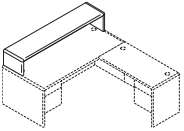

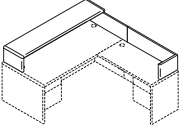
10700 SERIES™

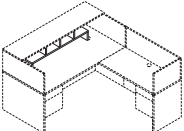
Shared Components and Accessories

| | DESCRIPTION | MODEL | SHIP WEIGHT | CUBE | LIST PRICE |
|---|--|-----------------|-------------|------|---------------|
|   | Reception Station/Transaction Counter 68 ⁵ / ₈ "W x 14 ⁵ / ₈ "D x 14 ¹ / ₄ "H Intended for use with H10700 72"W double and single pedestal desk models and 72"W desk shells. NOTES: Cord management grommets on desktops serve as anchor points. Transaction counter organizer (HTCOL52) fits under/inside of transaction counter. | H107720 | 76 | 3.2 | \$782 |
|   | Reception Station for an "L" Workstation 68 ⁵ / ₈ "W x 75 ⁵ / ₈ "D x 14 ¹ / ₄ "H Intended for use with a 72"W x 36"D left single pedestal desk or modular desk shell with a 42"W x 24"D right pedestal return or modular right return shell. Intended for use with a 72"W x 36"D right single pedestal desk or modular desk shell with a 42"W x 24"D left pedestal return or modular left return shell. NOTES: Cord management grommets on desktop and return serves as the anchor points for the reception station for return. | H107721R | 108 | 4.3 | \$1125 |
|   | Transaction Counter Organizer 48 ³ / ₄ "W x 11 ¹ / ₈ "D x 13"H Fits under Transaction Counter Models H107720, H107721R and H107722L. ! Black only. SPECIFYING EXAMPLE: HTCOL52.P | HTCOL52 | 24 | 1.1 | \$300 |
|  <p>Base sold separately.</p> | 42" Diameter Table Top NOTES: Underside of top features a factory-installed template. The template, which is trilingual, facilitates assembly of the base to the top by designating the specific attachment location for multiple base designs. Bases attach to the top with self drilling screws, no drilling is required. All top + base models are 29 ¹ / ₂ "H. For Base Options see Preside® Table Base in the Tables section in the 2021 Shared Spaces Pricer. ! Requires specification of a support base model shown in the Tables section in the 2021 Shared Spaces Pricer. SPECIFYING EXAMPLE: H107242.N | H107242 | 58 | 4.1 | \$751 |

NOTES:

- "L" Reception station includes components for both the reception/transaction counter for desk and the reception station for return.
- Round table design is well suited to a variety of applications, including use in private or open plan offices.
- See pages 346-358 for shared components.

HOW TO SPECIFY

| | |
|---|---|
| Select Model Number H 1 0 7 7 2 0 | Select Laminate See page 329 N N |
|---|---|

10700 SERIES™

Shared Components and Accessories

GSA SIN 33721

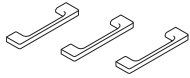
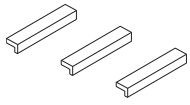

| DESCRIPTION | MODEL | SHIP WEIGHT | CUBE | LIST PRICE |
|---|------------------|-------------|------|-------------|
| Field Installable Drawer/Door Handle Kits | | | | |
| Linear, Black, 2-pack | HLINEARA2 | 0.4 | 0.3 | \$61 |
| Linear, Matte Chrome, 2-pack | HLINEARC2 | 0.4 | 0.3 | \$61 |
| Linear, Black, 3-pack | HLINEARA3 | 0.5 | 0.3 | \$69 |
| Linear, Matte Chrome, 3-pack | HLINEARC3 | 0.5 | 0.3 | \$69 |
| Specify Linear handles in black to coordinate with 10700 or 10500 Series™ models that ship standard with a decorative handle, such as mobile pedestals, storage cabinets and wardrobes. | | | | |
| Arch, Black, 2-pack | HARCHA2 | 0.4 | 0.3 | \$61 |
| Arch, Matte Chrome, 2-pack | HARCHC2 | 0.4 | 0.3 | \$61 |
| Arch, Black, 3-pack | HARCHA3 | 0.5 | 0.3 | \$69 |
| Arch, Matte Chrome, 3-pack | HARCHC3 | 0.5 | 0.3 | \$69 |

NOTES: Handles are for purchase and field installation on 10700 or 10500 Series™ desks, credenzas, returns, lateral files and modular pedestals. Instructions include mounting hardware and paper template for drilling holes.

Applications include:

- box/file and file/file pedestals = one 2-pack per pedestal
- box/box/file and pencil/media/file pedestals = one 3-pack per pedestal
- two drawer lateral file = two 2-packs per unit
- four drawer lateral file = four 2-packs per unit

The Linear and Arch handles can be attached using 96mm (approx. 3 $\frac{3}{4}$ "") or 128mm (approx. 5") hole spacing. Important note: effective January 1, 2007, the holes used for the black drawer/door handle that comes standard on several HON 10700 or 10500 Series™ products, including mobile pedestals, storage cabinet with doors, storage/file cabinet, storage cabinet/lateral file, personal wardrobe/storage cabinets, and personal storage towers, will accept the Linear and Arch handles. Units manufactured prior to January 1, 2007, have 64mm (approx. 2 $\frac{1}{2}$ "") hole spacing and will not accept the Linear and Arch handles.

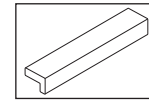

Linear Handle

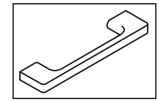

Arch Handle

! **Must be ordered with a configurable end product. If ordered separately, not on GSA contract.**



| | | | | |
|--|--------------------|-----|-----|-------------|
| Field Installable Drawer/Door Handle Kits | | | | |
| Sweep Black, 2-pack | HSWEEPA2 | 0.4 | 0.3 | \$47 |
| Sweep Satin Nickel, 2-pack | HSWEEPC2 | 0.4 | 0.3 | \$47 |
| Sweep Black, 3-pack | HSWEEPA3 | 0.5 | 0.3 | \$61 |
| Sweep Satin Nickel, 3-pack | HSWEEPC3 | 0.5 | 0.3 | \$61 |
| Crescent Black, 2-pack | HCRESCENTA2 | 0.4 | 0.3 | \$47 |
| Crescent Satin Nickel, 2-pack | HCRESCENTC2 | 0.4 | 0.3 | \$47 |
| Crescent Black, 3-pack | HCRESCENTA3 | 0.5 | 0.3 | \$61 |
| Crescent Satin Nickel, 3-pack | HCRESCENTC3 | 0.5 | 0.3 | \$61 |

NOTES: Handles are for purchase and field installation on 10700 or 10500 Series™ desks, credenzas, returns, and lateral files, as well as for the modular pedestals used with 10700 and 10500.

Applications include:

- box/file and file/file pedestals = one 2-pack per pedestal
- box/box/file and pencil/media/file pedestals = one 3-pack per pedestal
- two drawer lateral file = two 2-packs per unit
- four drawer lateral file = four 2-packs per unit

The hole spacing for the Sweep and Crescent handles is 96mm (approx. 3 $\frac{3}{4}$ ""). Important note: effective January 1, 2007, the holes used for the black drawer/door handle that comes standard on several HON 10700 or 10500 Series™ products, including mobile pedestals, storage cabinet with doors, storage/file cabinet, storage cabinet/lateral file, personal wardrobe/storage cabinets, and personal storage towers, will accept the Sweep and Crescent handles. Units manufactured prior to January 1, 2007, have 64mm (approx. 2 $\frac{1}{2}$ "") hole spacing and will not accept the Sweep and Crescent handles. Instructions include mounting hardware and paper template.

! **Must be ordered with a configurable end product. If ordered separately, not on GSA contract.**

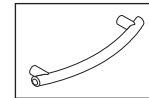

Sweep Handle

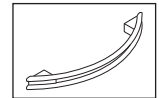

Crescent Handle

NOTES:

- Field Installable Drawer/Door Handle Kits for use on 10700 Series™ desks, credenzas, returns, lateral files and storage cabinets.
- A metal template is available to facilitate field installation of the Linear, Arch, Sweep and Crescent decorative handles on 10500 and 10700 Series™ drawer fronts; order model SPLH-SYST-DRKNB.M263164.
- See pages 346-358 for shared components.

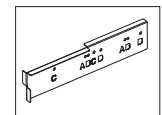

Metal Template

HOW TO SPECIFY

Select
Model Number

H L I N E A R A 2



10700 SERIES™

Shared Components and Accessories

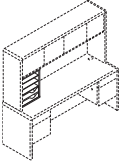
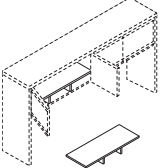
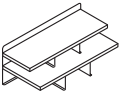
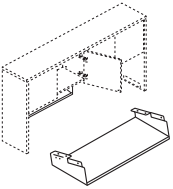
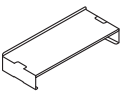
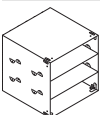
| | DESCRIPTION | MODEL | SHIP WEIGHT | CUBE | LIST PRICE |
|--|--|-----------------|-------------|------|--------------|
|  | Vertical Paper Manager 14 ⁷ / ₈ "W x 10 ⁷ / ₈ "D x 19 ¹ / ₁₆ "H NOTES: Keeps papers, files, and books neatly organized and within easy reach from a seated position. Designed for desk, credenza, and return tops. Fits under stack-on storage models. Two pullout drawers and three fixed shelves. Vertical paper manager designed for desk, credenza, and return tops. Fits under stack-on storage. For additional information see the Workplace Tools section in the 2021 Shared Spaces Pricer. | HLVPM1 | 27 | 2.8 | \$351 |
|  | Stacked Paper Management 32 ¹ / ₂ "W x 12 ⁵ / ₈ "D x 4 ¹ / ₄ "H NOTES: Segments and organizes stack-on and wall mount storage compartments, as well as bookcase shelves. In some cases, installation may require removing the stack-on or wall mount storage doors. For additional information see the Workplace Tools section in the 2021 Shared Spaces Pricer. ! Black only. | HLVPM2 | 22 | 1.25 | \$175 |
|  <i>Not available in two-tone laminate</i> | Desktop Storage Terrace 26 ¹ / ₂ "W x 12 ¹ / ₂ "D x 10 ¹ / ₂ "H NOTES: Keeps work-in-process, priority files, loose pages, and mail neatly organized and in view. Mixed material design comprised of sturdy laminate shelves with metal back and support panels. Not available in two-tone laminate combination or pattern laminate colors. Choose from Platinum Metallic (TI), Black (P), and Charcoal (S) for the metal components. Sized to fit in stack-on and wall mounted storage cabinets in 10500, 10700, Valido, 94000, and 38000 Series. Fits in Voi stack-on and overhead cabinets except for 48"W or smaller sliding door models. For additional information see the Workplace Tools section in the 2021 Shared Spaces Pricer. Specify: Model.Laminate.Paint SPECIFYING EXAMPLE: HLDSTI.N.TI | HLDSTI | 24 | 1.1 | \$329 |
|  | Hanging Paper Shelf 28 ¹ / ₁₆ "W x 11 ⁷ / ₁₆ "D x 4 ⁵ / ₁₆ "H NOTES: Maximizes worksurface space; de-clutters desktop while placing priority communications and active project folders within easy reach. Angled design allows contents to be distinguished at a glance. Mixed material styling features strong painted metal frame with a frosted shelf. Attaches quickly and easily to stack-on and wall mount storage models in the following series: 10500, 10700, Valido, 94000, and Voi (except the 36"W overhead hutch with O-legs or panel mount brackets). Not for use with 38000 Series. For additional information see the Workplace Tools section in the 2021 Shared Spaces Pricer. Specify: Model.Paint SPECIFYING EXAMPLE: HHPS1.TI | HHPS1 | 7 | 2.9 | \$214 |
|  | Desktop Paper Shelf 28 ¹ / ₁₆ "W x 11 ⁵ / ₁₆ "D x 5"H NOTES: Organizer shelf provides a place and space for work-in-process and piling to keep worksurfaces neat and tidy. Convenient, scalable design with interlocking side supports allow two units to be stacked and integrated. Durable painted metal frame with a frosted shelf; mixed material styling matches hanging paper shelf. Can also be used inside select overhead storage, including the following stack-on with hinged door models: 10500 and Valido 36", 42", 66", 72", 78"W and 10700 68 ⁵ / ₈ "W. For additional information see the Workplace Tools section in the 2021 Shared Spaces Pricer. Specify: Model.Paint SPECIFYING EXAMPLE: HDPS1.TI | HDPS1 | 7 | 2.9 | \$214 |
|  | Storage Cube 12"W x 12"D SPECIFYING EXAMPLE: HLSL1212.P8S | HLSL1212 | 1 | 0.3 | \$316 |

NOTES:

- See pages 346-358 for shared components.

HOW TO SPECIFY

| | |
|---|--|
| Select Model Number H L V P M 1 . N | Select Laminate See page 329 |
|---|--|











10700 SERIES™

Shared Components and Accessories

OPEN MARKET EXCEPT AS NOTED



Icon Legend on page 19

| | DESCRIPTION | MODEL | SHIP WEIGHT | CUBE | LIST PRICE |
|---|---|---------------|--|------|--------------|
|  Refer to page 104 for Center Drawer compatibility information SIN 33721 | Angled Wood Center Drawer 26" x 15 ³ / ₈ " 22" x 15 ³ / ₈ " NOTES: Center drawers ideal for pens, pencils and other miscellaneous storage. Feature ball-bearing slide suspension. Compatibility (where to use) information is detailed on page 104. Specify laminate for drawer. Model H1522 or H1022 can be used on peninsulas with modesty panel, model H10528. For additional information see the Workplace Tools section in the 2021 Shared Spaces Pricer. | H1526 | 12.0  | 1.2 | \$214 |
| | | H1522 | 11.0  | 1.1 | \$199 |
|  SIN 33721 | Polymer Center Drawer <ul style="list-style-type: none"> Color: Black. Material: ABS. Minimum clearance for mounting: 23"W x 16¹/₄"D x 2"H. Retracts on 16" ball-bearing slides. Can be used on worksurfaces with Coordinate™ Height Adjustable Bases as long as it is attached with spacer model HKBS. Can store up to 25 lbs.  Black finish only, no specification needed. | HCD1 | 7.0 | 0.5 | \$126 |
|  SIN 33721 | Black Removable Lock Core Kit — see page 773. NOTES: Lock with a removable cylinder that can be interchanged as needed; allows users to access all furniture pieces in an office with a single key for convenience and security. Makes re-keying quick and easy. | HF23B | 0.1 | 0.1 | \$35 |
|  SIN 33721 | Removable Lock Core Kit Black <ul style="list-style-type: none"> For stack-on and wall mounted storage laminate models (with locks) in 10500, 10700, Valido, Voi, Concinnity, and 94000 Series. Specify quantity of each key number from 101E to 225E. Includes: 1-core, 2-keys, 1-core removal tool, and instructions. NOTES: If key number isn't specified, number will be at random. | HF27B | 0.2 | 0.02 | \$35 |
|  SIN 33721 | Back Pack Hook (10 per carton) 12"W x 14 ¹ / ₂ "D x 1 ¹ / ₂ "H NOTES: Assembly: attaches to bottom of desk with (2) screws, included.  Available in Platinum Metallic finish only, no specification needed. | HCLA65 | 10.0  | 0.1 | \$101 |

NOTES:

- For master key, see model HF22 on page 773.
- See pages 346-358 for shared components.

HOW TO SPECIFY

| | |
|---|---|
| Select Model Number H 1 5 2 6 . | Select Laminate See page 329 N N |
|---|---|



10700 SERIES™

Shared Components and Accessories



Refer to the Workplace Tools section in the 2021 Shared Spaces Pricer for additional product information

SIN 33721



| DESCRIPTION | MODEL | SHIP | | LIST PRICE BY PAINT GRADE | |
|---|--------------------------|--------|------|---------------------------|--------------|
| | | WEIGHT | CUBE | P1 | P2 |
| Slide-Away Keyboard Platform (Specify: Laminate) | H4022 | 10 | 0.6 | \$228 | |
| Extended Tray Slide-Away Keyboard Platform (Specify: Laminate) | HE4022 | 12 | 0.7 | \$323 | |
| Metal Keyboard and Mouse Tray (Specify paint) | H4028 OPEN MARKET | 11 | 1.5 | \$164 | \$174 |
| Metal Keyboard Tray (Specify paint) | H4029 OPEN MARKET | 11 | 1.5 | \$148 | \$158 |
| Corner Sleeve — Square Edge (22½" leading edge x 18"D) Specify paint color. | H51206 | 10 | 1.5 | \$171 | \$181 |

NOTES: For additional information see the Workplace Tools section in the 2021 Shared Spaces Pricer.



SIN 33721

| DESCRIPTION | MODEL | SHIP WEIGHT | CUBE | LIST PRICE |
|---|----------------|-------------|------|--------------|
| LED Task Lights | | | | |
| Articulating Desk Lamp | HLED1 | 1.2 | 6.5 | \$430 |
| Articulating Desk Lamp w/ Occupancy Sensor | HLED1OC | 1.2 | 6.5 | \$524 |

NOTES: For additional information see the Workplace Tools section in the 2021 Shared Spaces Pricer.



SIN 33721

| | | | | |
|-----------------------|--------------|-----|-----|--------------|
| Task Desk Lamp | HLED2 | 0.7 | 3.0 | \$373 |
|-----------------------|--------------|-----|-----|--------------|

NOTES: For additional information see the Workplace Tools section in the 2021 Shared Spaces Pricer.



OPEN MARKET

| DESCRIPTION | MODEL | SHIP WEIGHT | CUBE | LIST PRICE |
|--|--------------------|-------------|------|--------------|
| LED Task Lights — for Stack-on Storage Models | | | | |
| 17" LED Light with Power Supply (Single) | HLED17AS ☉ | 1.2 | 0.05 | \$450 |
| 31" LED Light with Power Supply (Single) | HLED31AS ☉ | 1.5 | 0.09 | \$603 |
| 17" LED Light with Power Supply for Daisy-chain (Starter) | HLED17A | 1.0 | 0.05 | \$493 |
| 31" LED Light with Power Supply for Daisy-chain (Starter) | HLED31A | 1.4 | 0.09 | \$662 |
| 17" LED Light with 8" and 30" Jumper Cord for Daisy-chain (Follower) | HLED17AUO ☉ | 1.0 | 0.03 | \$404 |
| 31" LED Light with 8" and 30" Jumper Cord for Daisy-chain (Follower) | HLED31AUO ☉ | 1.0 | 0.05 | \$539 |

| | | | | |
|---|------------------|-----|------|-------------|
| Undercabinet Occupancy Sensor with 1" End to End Connector | HLEDOSA ☉ | 0.2 | 0.01 | \$97 |
|---|------------------|-----|------|-------------|

NOTES: To use the daisy chain application, must start with model HLED17A or HLED31A. No finish specification required. Attaches magnetically to underside of overhead storage, or attaches with provided screws or double-sided tape. Occupancy sensor attaches to a single or starter LED light and will automatically turn the light off after no motion is detected for 30 minutes. Just like all the LED light models, the occupancy sensor features a soft-touch on/off switch. LED task lights have a lifetime of 30,000 hours and have a dimmer feature that allows the user to adjust the amount of light output.



Refer to the Workplace Tools section in the 2021 Shared Spaces Pricer

OPEN MARKET

| | | | | |
|---|-----------------|------|-----|--------------|
| Task Light — for Stack-on Storage Models | | | | |
| 46½"W x 3½"D x 1½"H, for models H107318, H10734, H10733 or H10732 | HH870960 | 12.0 | 1.1 | \$290 |
| 34½"W x 3½"D x 1½"H, for model H107313 | HH870942 | 10.0 | 0.9 | \$267 |

NOTES: Task light and Chicago Code models see page 595. For additional information see the Workplace Tools section in the 2021 Shared Spaces Pricer.

NOTES:

- Task lights are designed for use with stack-on storage and wall mounted storage cabinets.
- Task lights feature a new slim profile and electronic ballast for increased energy efficiency.
- Task lights include a T5 bulb which contains less mercury.

10700 SERIES™

Shared Components and Accessories

GSA SIN 33721T EXCEPT AS NOTED

ABI

Icon Legend on page 19



SIN 33721

DESCRIPTION**MODEL****SHIP WEIGHT****CUBE****LIST PRICE****Field Installable Grommet****HFLDGRMT**

0.1 Ⓢ

0.01

\$35

- Intended for use in tops and end panels to route/hide cords and in modesty panels to facilitate reaching wall electrical outlets.
- Grommet is field installable.
- Grommet shape is round.
- Includes grommet cap and sleeve.
- Grommet cap measures 3" diameter and includes a 3/4" diameter cord access hole.
- Grommet sleeve measures 2 1/2" O.D. x 3/4" thick.
- Includes instructions to locate grommet position for desks, credenzas, returns and bridges.

! Black Finish

! Requires a 2 1/2" diameter hole saw and drill for installation (not included).



SIN 33721

Field Installable Grommet**HFLDGRMT3**

0.1 Ⓢ

0.3

\$135

- Intended for use in tops and end panels to route/hide cords and in modesty panels to facilitate reaching wall electrical outlets.
- Grommet is field installable.
- Grommet shape is round.
- Includes grommet cap and sleeve.
- Grommet outside dimensions measure 3 1/2" diameter and includes two cord access holes.
- Grommet sleeve measures 3" O.D. x 1" thick.
- Includes instructions to locate grommet position for desks, credenzas, returns and bridges.

! Black Finish

! Requires a 3" diameter hole saw and drill for installation (not included).

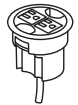
**Power Hub, 3" Grommet Mount, 6' Cord****HGRMTAC**

1.3

0.2

\$126

- Two grounded AC power outlets.
- Two cord pass-through holes in cap.
- Includes 6' cord with three-prong plug.

! Available in Black only (no color designation - Specify: HGRMTAC.X).

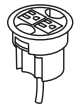
**3" Round Power Grommet - 2 Outlets, 10' Cord****HGRMTAC2**

1.5

0.2

\$159

- Includes 10' cord with three-prong plug.
- Fits in 3" round grommet holes on the following product lines: Coordinate, Huddle, Motivate, all laminate casegoods series, and Systems Worksurfaces.
- Two grounded AC power outlets.
- Field installed with Plug-and-play ease.

NOTES: Power Modules will also work with standing-height applications for 10500 Series™ and Voi® desks. Optional Memory Control allows preset worksurface heights for consistency. Ships separately. Dynamic load capacity when worksurface is moving is 300 lbs.

! Available in black finish only, no specification needed.

**Power/USB Hub, 3" Grommet Mount****HGRMTUSB2**

1.3 Ⓢ

0.02

\$250

- One grounded AC power outlet with 2 USB ports.
- Two cord pass-through holes in cap.
- Includes 6' cord with three-prong plug.

! Available in black only (no color designation so use .X - Specify: HGRMTUSB2.X).

NOTES:

- The power and power/USB hub models bring the ease of plug-and-play to the desktop.
- Models HFLDGRMT3, HGRMTAC, and HGRMTUSB2 fit in 3" round grommet holes in 10700 Series™ desks, credenzas, and returns; not compatible with 10700 products with rectangle-shaped grommets.
- For additional information see the Workplace Tools section in the 2021 Shared Spaces Pricer.

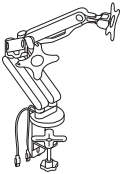

| | DESCRIPTION | MODEL | SHIP WEIGHT | CUBE | LIST PRICE |
|---|--|-----------------|-------------|------|--------------|
|  | <p>Coordinate™ Portable Desktop Riser 31"D x 5"-16½"H x 35"W</p> <p>NOTES: Available in Black (BLK) or White (WHT) finish. Desktop riser dimensions (without keyboard tray): 22"D x 5"-16½"H x 35"W. Keyboard tray dimensions: 9"D x 30"W. Max loading capacity is 33 lbs for the desktop riser surface and 4 lbs for the keyboard tray. Easily transition from seated to standing positions throughout the workday. Sits atop an existing desk to create sit-to-stand functionality by raising the computer. Includes keyboard tray and surface for computer monitors. HON 5-Year Limited Warranty.</p> <p>⚠ Not intended for use on mobile workstations.</p> | HBXRISER | 54.0 | 4.1 | \$657 |
|  | <p>Dual Monitor Arm with 2 USB Ports</p> <p>NOTES: Easy adjustment. Height adjusts to 17" tall. Monitor tilt and swivel capability. Enclosed cable management. Grommet or desktop mounting. Clean appearance. In some applications the Monitor Arms may extend 12 or more inches into the worksurface. For additional information see the Workplace Tools section in the 2021 Shared Spaces Pricer. HON 5-Year Limited Warranty.</p> <p>⚠ No specification needed.</p> | HBDMAUSB | 41.9 | 2.6 | \$410 |

HOW TO SPECIFY

| | |
|--|---|
| <p>Select Model Number</p> <p>HBXRISER.</p> | <p>Select Finish</p> <p>BLK Black WHT White</p> <p>BLK</p> |
|--|---|

10700 SERIES™ Accessories

OPEN MARKET



Icon Legend on page 19

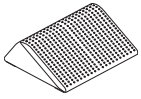

DESCRIPTION

Footrest — Anti-Slip Cover
13¾"D x 5½"H x 16"W

ⓘ Available in Black (T) finish ONLY. Recommended weight capacity not to exceed 250 pounds. **HON 5-Year Limited Warranty.**
SPECIFYING EXAMPLE: HVL991.T

MODEL

HVL991

SHIP WEIGHT

7 ⓘ

CUBE

0.9

LIST PRICE

\$89

HOW TO SPECIFY

| | |
|--|---|
| <p>Select Model Number</p> <p>H V L 9 9 1 .</p> | <p>Select Finish</p> <p>T Black</p> <p>T</p> |
|--|---|

94000 SERIES™

Want to see more? Scan here
to check out hon.com.



94000 Series™ shown with 6550 Series Seating.

94000 SERIES™

Confident. Accomplished. Your office speaks volumes about you, and the 94000 Series says all the right things. Exceptionally crafted and solidly engineered, it's finished with warm, durable mahogany laminate — a timeless example of classic beauty and executive elegance.



FEATURES

- Traditional furniture design features solid wood trim and plinth style bases.
- From gleaming brass fixtures to raised accent moldings, details make this desk a standout.
- Our comprehensive selection makes it easy to create a complete executive look.
- It's all about the amenities — like pull out writing surfaces for extra room when you need it and central locking center drawers on all desks.

94000 SERIES™

Typicals



Icon Legend on page 19

Components used are listed on pages 364-369. Order components individually. Other configurations are possible, including various sizes of some components.

| QTY | DESCRIPTION | MODEL | LIST PRICE | PRICE EXTENSION |
|---------------|---|--------|----------------|-----------------|
| 1 | Double Pedestal Desk 72"W x 36"D x 29½"H | H94271 | \$2,725 | \$2,725 |
| 1 | Credenza with Kneespace 72"W x 24"D x 29½"H | H94243 | \$2,276 | \$2,276 |
| 1 | Stack-on Storage 70"W x 16⅞"D x 37"H | H94234 | \$1,640 | \$1,640 |
| TOTAL: | | | \$6,641 | |

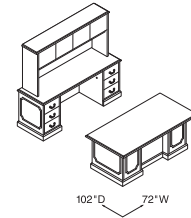

DESK WORKSTATION
72"W x 102"D

| QTY | DESCRIPTION | MODEL | LIST PRICE | PRICE EXTENSION |
|---------------|---|-----------|----------------|-----------------|
| 1 | Laminate Rectangle Top with Traditional Edge Detail 72"W x 36"D | HTLC3672T | \$1,167 | \$1,167 |
| 1 | Laminate Traditional Panel Base 29½"H with HTLC3672T Top | HTLT72 | \$818 | \$818 |
| 1 | Credenza with Doors 72"W x 24"D x 29½"H | H94244 | \$2,627 | \$2,627 |
| 1 | Stack-on Storage 70"W x 16⅞"D x 37"H | H94234 | \$1,640 | \$1,640 |
| TOTAL: | | | \$6,252 | |

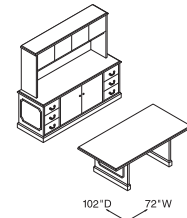
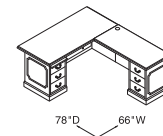

TABLE WORKSTATION
72"W x 102"D

| QTY | DESCRIPTION | MODEL | LIST PRICE | PRICE EXTENSION |
|---------------|--|---------|----------------|-----------------|
| 1 | Single Pedestal Desk, Left 66"W x 30"D x 29½"H | H94284L | \$2,241 | \$2,241 |
| 1 | Right Return - box/file 48"W x 24"D x 29½"H | H94215R | \$1,530 | \$1,530 |
| TOTAL: | | | \$3,771 | |



DESK "L" WORKSTATION - RIGHT
66"W x 78"D



Icon Legend on page 19

94000 SERIES™ Typicals

Components used are listed on pages 364-369. Order components individually. Other configurations are possible, including various sizes of some components.

| QTY | DESCRIPTION | MODEL | LIST PRICE | PRICE EXTENSION |
|---------------|---|---------|----------------|-----------------|
| 1 | Single Pedestal Desk, Right 66"W x 30"D x 29½"H | H94283R | \$2,241 | \$2,241 |
| 1 | Left Return - box/file 48"W x 24"D x 29½"H | H94216L | \$1,530 | \$1,530 |
| 1 | Stack-on-Storage 76"W x 16⅞"D x 37"H | H94237 | \$1,708 | \$1,708 |
| TOTAL: | | | \$5,479 | |

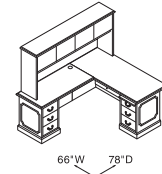

DESK "L" WORKSTATION - LEFT
66"W x 78"D

| QTY | DESCRIPTION | MODEL | LIST PRICE | PRICE EXTENSION |
|---------------|---|---------|----------------|-----------------|
| 1 | Single Pedestal Desk, Left 72"W x 36"D x 29½"H | H94286L | \$2,385 | \$2,385 |
| 1 | Bridge 48"W x 24"D x 29½"H | H94270 | \$900 | \$900 |
| 1 | Single Pedestal Credenza, Right 72"W x 24"D x 29½"H | H94245R | \$1,967 | \$1,967 |
| 1 | Stack-on Storage 70"W x 16⅞"D x 37"H | H94234 | \$1,640 | \$1,640 |
| TOTAL: | | | \$6,892 | |

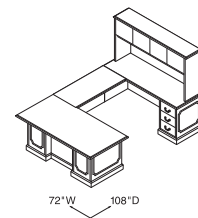

DESK "U" WORKSTATION - RIGHT
72"W x 108"D

| QTY | DESCRIPTION | MODEL | LIST PRICE | PRICE EXTENSION |
|---------------|--|---------|----------------|-----------------|
| 1 | Single Pedestal Desk, Right 72"W x 36"D x 29½"H | H94285R | \$2,385 | \$2,385 |
| 1 | Bridge 48"W x 24"D x 29½"H | H94270 | \$900 | \$900 |
| 1 | Credenza w/Lateral, Left 72"W x 24"D x 29½"H | H94248L | \$2,234 | \$2,234 |
| 1 | Stack-on Storage w/Glass Doors 70"W x 16⅞"D x 37"H | H94236 | \$2,194 | \$2,194 |
| TOTAL: | | | \$7,713 | |

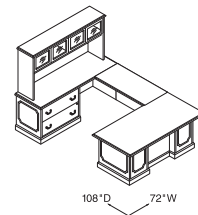

DESK "U" WORKSTATION - LEFT
72"W x 108"D

94000 SERIES™ Laminate Wood Desks

GSA SIN 33721



Icon Legend on page 19

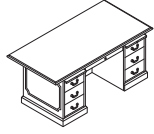

DESCRIPTION

Double Pedestal Desk 2-2 — Box/File
72"W x 36"D x 29½"H

**FULL WIDTH
OVERHANG**

7"

MODEL

H94271

**SHIP
WEIGHT**

307

CUBE

52.9

**LIST
PRICE**

\$2725

NOTES: 7" conference overhang on approach side (provides kneespace for visitors), and a 6¾" conference overhang on each end. Convenient pull out writing shelf above pedestal provides added workspace. Center drawer features central locking (locks all drawers).

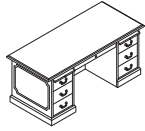

Double Pedestal Desk 2-2 — Box/File

66"W x 30"D x 29½"H
60"W x 30"D x 29½"H

1"

H94276

340

42.8

\$2656

1"

H94251

284

39.0

\$2564

NOTES: Convenient pull out writing shelf above pedestal provides added workspace. Center drawer features central locking (locks all drawers).

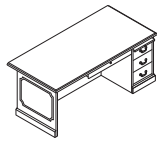

Single Pedestal Desk — Box/File

72"W x 36"D x 29½"H, Right
66"W x 30"D x 29½"H, Right
72"W x 36"D x 29½"H, Left
66"W x 30"D x 29½"H, Left

7"

H94285R

275

54.0

\$2385

1"

H94283R

233

42.8

\$2241

7"

H94286L

275

54.0

\$2385

1"

H94284L

233

42.8

\$2241

NOTES: Convenient pull out writing shelf above pedestal provides added workspace. Center drawer features central locking (locks all drawers).

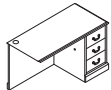

Model H94215R shown

Return — Box/File

48"W x 24"D x 29½"H, Right
42"W x 24"D x 29½"H, Right
48"W x 24"D x 29½"H, Left
42"W x 24"D x 29½"H, Left

H94215R

154

24.9

\$1530

H94211R

146

22.1

\$1418

H94216L

154

24.9

\$1530

H94212L

146

22.1

\$1418

NOTES: Drawers lock. One round cord grommet in the top. One cord pass-through grommet in the modesty panel to facilitate reaching wall electrical outlets.

⚠ Not designed to be used freestanding.

NOTES:

- 18th century elegance, 21st century engineering.
- Traditional furniture applications include state and local government, military bases, banks, and attorney offices.
- Tops are premium abrasion- and stain-resistant high pressure, high-gloss laminate over durable 1⅛" solid core high-performance particleboard.
- Solid wood edge profile.
- Antique brass drawer pulls; hand-applied raised decorative molding, and plinth style base.
- Pullout reference/writing shelf is standard on all desk pedestals.
- Desk, credenza, and return drawers are 5-sided construction, which allows easy drawer alignment or replacement of drawer fronts.
- Center drawer on desks equipped with built-in pencil tray and central locking (locks all drawers).
- Drawers operate on full extension, ball-bearing suspensions to ensure smooth, quiet, long-lasting operation.
- File drawer design includes integrated hangrails for side-to-side letter or legal filing; and front-to-back for letter filing.
- Locking units equipped with interchangeable core removable locks.
- Adjustable hex leveling glides allow floor-standing furniture to be easily leveled without lifting the unit; glides have ¾" adjustable range.



⚠ Keyed alike cores must be ordered separately — see model HF23B on page 773 — makes re-keying quick and easy.

HOW TO SPECIFY

| | |
|---|--|
| <p>Select Model Number</p> <p>H 9 4 2 7 1</p> | <p>Select Laminate</p> <p>NN Mahogany</p> <p>N N</p> |
|---|--|

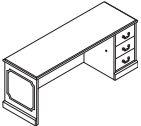
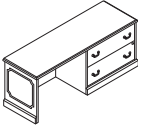
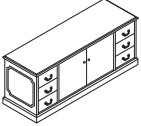
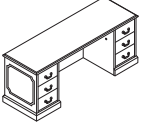

94000 SERIES™ Laminate Wood Desks

| | DESCRIPTION | MODEL | SHIP WEIGHT | CUBE | LIST PRICE |
|--|---|----------------------------------|-------------|--------------|--------------------------------|
|   | Bridge (single ped. desk to single ped. credenza or credenza with lateral) 48"W x 24"D x 29½"H, (clear inside depth is 22½"D) 42"W x 24"D x 29½"H, (clear inside depth is 22½"D) | H94270 H94260 | 85 76 | 4.3 4.3 | \$900 \$833 |
| | NOTES: One cord pass-through grommet in top center of modesty panel to facilitate reaching wall electrical outlets. Kneespace of desk is limited to 24¾"W if bridge is used with 66"W single pedestal desk. | | | | |
|  Model H94245R shown | Credenza, Single Pedestal — Box/File 72"W x 24"D x 29½"H, Right 72"W x 24"D x 29½"H, Left | H94245R H94246L | 230 230 | 36.0 36.0 | \$1967 \$1967 |
| | NOTES: Drawers lock. One cord pass-through grommet in top center of modesty panel to facilitate reaching wall electrical outlets. See pages 366-367 for optional Overhead Hutch and Stack-on Storage. | | | | |
|  Model H94247R shown | Credenza with 36" Lateral 72"W x 24"D x 29½"H, Right 72"W x 24"D x 29½"H, Left | H94247R H94248L | 239 239 | 36.0 36.0 | \$2234 \$2234 |
| | NOTES: Lateral file drawers lock. See pages 366-367 for optional Overhead Hutch and Stack-on Storage. | | | | |
|  Model H94244 shown | Credenza with Doors — Box/File 72"W x 24"D x 29½"H | H94244 | 313 | 36.0 | \$2627 |
| | NOTES: All drawers lock. Doors are non-locking. One removable shelf (38¾"W x 13¾"D). Shelf is not adjustable. See pages 366-367 for optional Overhead Hutch and Stack-on Storage. | | | | |
|  Model H94243 shown | Credenza with Kneespace — Box/File 72"W x 24"D x 29½"H | H94243 | 253 | 36.0 | \$2276 |
| | NOTES: All drawers lock. One cord pass-through grommet in top center of modesty panel to facilitate reaching wall electrical outlets. See pages 366-367 for optional Overhead Hutch and Stack-on Storage. | | | | |

NOTES:

- 18th century elegance, 21st century engineering.
- Tops are premium abrasion- and stain-resistant high pressure, high-gloss laminate over durable 1½" solid core high-performance particleboard.
- Solid wood edge profile.
- Antique brass drawer pulls; hand-applied raised decorative molding, and plinth style base.
- Pullout reference/writing shelf is standard on all desk pedestals.
- Desk, credenza, and return drawers are 5-sided construction, which allows easy drawer alignment or replacement of drawer fronts.
- Center drawer on desks equipped with built-in pencil tray and central locking (locks all drawers).
- Drawers operate on full extension, ball-bearing suspensions to ensure smooth, quiet, long-lasting operation.
- File drawer design includes integrated hangrails for side-to-side letter or legal filing; and front-to-back for letter filing.
- Locking units equipped with interchangeable core removable locks.
- 94000 Series™ products produced after 10/26/98 have been improved with a thicker top. Joining with older products before that date may cause misalignment.
- Adjustable hex leveling glides allow floor-standing furniture to be easily leveled without lifting the unit; glides have ¾" adjustable range.

ⓘ Keyed alike cores must be ordered separately — see model HF23B on page 773 — makes re-keying quick and easy.

HOW TO SPECIFY

| | |
|---|---------------------------------------|
| Select Model Number H 9 4 2 4 5 R | Select Laminate NN Mahogany |
|---|---------------------------------------|

94000 SERIES™ Laminate Wood Desks

GSA SIN 33721



Icon Legend on page 19

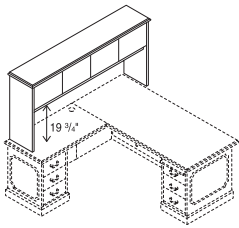

DESCRIPTION

Stack-on Storage for 78" D "L" Shaped Workstation

76"W x 16 1/8"D x 37"H (Accepts Back Enclosure H107358, Fabric Tackboard H90035 and Task Light HH870960.)

MODEL

H94237

SHIP WEIGHT

198

CUBE

18.4

LIST PRICE

\$1708

Stack-on Storage for 78" D "L" Shaped Workstation, Locking

76"W x 16 1/8"D x 37"H (Accepts Back Enclosure H107358, Fabric Tackboard H90035 and Task Light HH870960.)

H94237K

198

18.4

\$1808

NOTES: Spans the total dimension of "L" shaped layouts comprised of a 48"W return attached to a 30"D single pedestal desk (78"D); or a 42"W return attached to 36"D single pedestal desk (78"D). For vertical paper manager model HLVPM1, see page 369.

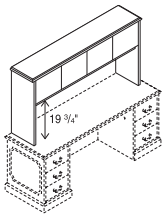

Stack-on Storage

70"W x 16 1/8"D x 37"H (Accepts Back Enclosure H10738, Fabric Tackboard H90034 and Task Light HH870960.)

H94234

175

18.0

\$1640

Stack-on Storage, Locking

70"W x 16 1/8"D x 37"H (Accepts Back Enclosure H10738, Fabric Tackboard H90034 and Task Light HH870960.)

H94234K

175

18.0

\$1729

NOTES: For use on 72"W credenza models or on 72"D "L" shaped workstations comprised of a 30"D single pedestal desk and a 42"W return. Inside storage contains two compartments each sized: 31 3/4"W x 12 1/8"D x 12"H. Vertical paper manager, model HLVPM1, fits under stack-on storage. See page 369.

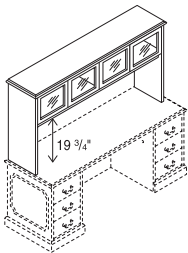

Stack-on Storage with Glass Doors

70"W x 16 1/8"D x 37"H (Accepts Back Enclosure H10738 and Fabric Tackboard H90034.) (Use Task Light HH870960, see page 367)

H94236

171

18.0

\$2194

NOTES: Elegant wood-framed, clear glass door design. For use on 72"W credenza models or on 72"D "L" shaped workstations comprised of a 30"D single pedestal desk and a 42"W return. No lock option for glass doors. For vertical paper manager model HLVPM1, see page 369.

NOTES:

- Stack-on storage equipped with self-closing, adjustable hinged doors.
- Stack-on storage design includes valance to hide task light.
- Vertical paper manager keeps papers, files and books organized and within easy reach from a seated position. Fits under stack-on storage models. See page 369.
- Stacked paper management segments and organizes stack-on storage compartments and bookcase shelves. Unit can be used in models H94327, H94234 and H94236. In some cases, installation may require removing the stack-on storage doors. See page 355.
- For a variety of work-in-process paper management tools, see pages 319-320.
- Overhead Hutch features one cord pass-through grommet located in bottom center of back panel.
- ❗ Overhead Hutch is not designed to accept task light.
- ❗ Removable lock core kit for locking stack-on storage is model HF27B. See page 773.



HOW TO SPECIFY

| | |
|--|---|
| <p>Select Model Number</p> <p>H 9 4 2 3 7</p> | <p>Select Laminate</p> <p>NN Mahogany</p> <p>N N</p> |
|--|---|

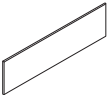

Icon Legend on page 19

94000 SERIES™ Laminate Wood Desks

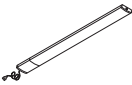
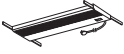
| | DESCRIPTION | MODEL | COM | SHIP WEIGHT | CUBE | LIST PRICE |
|---|--|-------------------|-----|-------------|------|--------------|
|  18 ⁵ / ₈ "H | Back Enclosure for Stack-on Storage 76"W model #H94237 70"W model #H94234 or H94236 | H107358 | | 34.0 | 1.30 | \$303 |
| | | H10738 | | 31.0 | 1.30 | \$279 |
| NOTES: Specify laminate with a single designator. Non-tackable surface. Feature full width 1 ¹ / ₈ " slot at bottom to facilitate routing cords and reaching wall electrical outlets. SPECIFYING EXAMPLE: H107358.N | | | | | | |
|  18"H | Taskboards for use with Stack-on Storage Back Enclosures (Back Enclosures must be ordered separately.) 71 ¹ / ₂ "W for 76"W model #H94237 Stack-on with #H107358 Enclosure 65 ¹⁵ / ₁₆ "W for 70"W model #H94234 or H94236 Stack-on with #H10738 Enclosure | H90035 | 2.0 | 13.0 | 2.80 | \$353 |
| | | H90034 | 2.0 | 11.0 | 2.00 | \$337 |
| NOTES: Specify fabric selection from pages 25-26. Upcharges may apply to premium fabric grades. Taskboards are sized ³ / ₄ " narrower than respective stack-on storage back enclosure, allowing ³ / ₈ " each side to route task light cords. Attached to back enclosure using latch & hook tape provided. ⓘ Disperse (DISP) fabric not available on sizes wider than 60". SPECIFYING EXAMPLE: H930035.APN15 | | | | | | |
|  OPEN MARKET | LED Task Lights — For Stack-on and Wall Mounted Storage Cabinets 17" LED Light with Power Supply (Single) 31" LED Light with Power Supply (Single) | HLED17AS ⓘ | | 1.2 ⓘ | 0.05 | \$450 |
| | | HLED31AS ⓘ | | 1.5 ⓘ | 0.09 | \$603 |
| NOTES: No finish specification required. Attaches magnetically to underside of overhead storage, or attaches with provided screws or double-sided tape. Occupancy sensor attaches to a single or starter LED light and will automatically turn the light off after no motion is detected for 30 minutes. Just like all the LED light models, the occupancy sensor features a soft-touch on/off switch. LED task lights have a lifetime of 50,000 hours and have a dimmer feature that allows the user to adjust the amount of light output. | | | | | | |
|  <i>Refer to the Workplace Tools section in the 2021 Shared Spaces Pricer</i> OPEN MARKET | Recessed Task Light 46 ¹ / ₂ "W x 3 ¹ / ₁₆ "D for Models H94234, H94234K, H94236, H94237 and H94237K. Chicago code version (with fused plug) | HH870960 | | 12.0 ⓘ | 1.10 | \$290 |
| | | HH870960CH | | 12.0 ⓘ | 1.10 | \$361 |
| NOTES: For additional information see the Workplace Tools section in the 2021 Shared Spaces Pricer. | | | | | | |

NOTES:

- Stack-on storage equipped with self-closing, adjustable hinged doors.
 - Stack-on storage design includes valance to hide task light.
 - Vertical paper manager keeps papers, files and books organized and within easy reach from a seated position. Fits under stack-on storage models. See page 369.
 - Stacked paper management segments and organizes stack-on storage compartments and bookcase shelves. Unit can be used in models H94237, H94234 and H94236. In some cases, installation may require removing the stack-on storage doors. See page 355.
 - For a variety of work-in-process paper management tools, see pages 319-320.
- ⓘ Removable lock core kit for locking stack-on storage is model HF27B. See page 773.

HOW TO SPECIFY

| | |
|---|--------------------------------------|
| Select Model Number H 1 0 7 3 5 8 | Select Laminate N Mahogany |
|---|--------------------------------------|



94000 SERIES™

Laminate Wood Desks

GSA SIN 33721

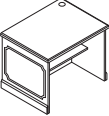
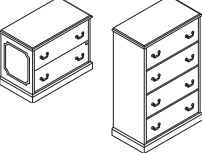
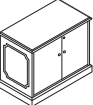
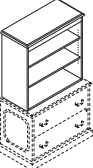
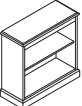

Icon Legend on page 19

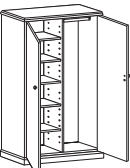
| | DESCRIPTION | MODEL | SHIP WEIGHT | CUBE | LIST PRICE |
|--|---|--|--------------------------|------------------------------|---|
|  | Computer Work Table with cord grommet 36"W x 30"D x 29½"H NOTES: One removable shelf (32⅓"W x 12⅝"D). | H94226 | 130 | 23.8 | \$1243 |
|  | Lateral Files (with core removable lock) 37½"W x 20½"D x 29½"H — two drawer 37½"W x 20½"D x 59⅞"H — four drawer NOTES: High capacity file storage. Includes hangrails; mechanical interlock inhibits the extension of more than one drawer at a time. Two drawer design is equipped with a counterweight. | H94223 H94229 | 172 300 | 17.7 34.0 | \$1570 \$2694 |
|  | Storage Cabinet (with core removable lock) 37½"W x 20½"D x 29½"H NOTES: Bookcase hutch H94210 can be used with H94291. One adjustable shelf, adjusts in 1¼" increments. | H94291 | 165 | 16.7 | \$1408 |
|  | Bookcase Hutch 35¾"W x 14⅝"D x 37"H, (3 shelves; 2 adjustable, includes bottom of unit) Designed to be used on model H94223 lateral file or model H94291 storage cabinet. NOTES: One cord pass-through grommet located at bottom center of back panel. Two adjustable shelves, adjust in 1¼" increments. | H94210 | 95 | 14.0 | \$1053 |
|  | Bookcase 35¾"W x 14⅝"D x 35½"H, 2-Shelf 35¾"W x 14⅝"D x 49⅝"H, 3-Shelf 35¾"W x 14⅝"D x 64"H, 4-Shelf 35¾"W x 14⅝"D x 78¼"H, 5-Shelf NOTES: Fixed shelves. | H94221 H94222 H94224 H94225 | 100 130 160 200 | 14.8 20.6 26.3 32.3 | \$983 \$1101 \$1249 \$1369 |
|  | Bookcase with Glass Doors 35¾"W x 14⅝"D x 49⅝"H NOTES: Upscale design brings order, utility and a touch of elegance to the traditional office. Wood-framed, clear glass doors with hinges provide easy access to interior. Three fixed shelves provide spacious storage. Shelf measures 32¾"W x 11¾"D. Bookcase with glass doors brings order, utility and a touch of elegance to the traditional office. ⓘ Doors are not designed to lock. | H94220 | 155 | 20.6 | \$1755 |
|  | Storage Cabinet/Lateral File (with core removable lock) 37½"W x 24"D x 66½"H NOTES: Standard with one fixed and two full-width adjustable shelves in top compartment; adjustable shelves can be removed. Overall storage compartment measures 33¾"W x 22"D x 36⅞"H and will accommodate supplies, books and binders, as well as business machines and electronic equipment. Cord pass-through gap behind shelves and grommet in back of the cabinet to facilitate routing cords and reaching wall electrical outlets. Two drawer lateral file on bottom. Lateral file comes with mechanical interlock and hangrails. Cabinet and lateral file lock independently. Unit height is designed to match credenza or return plus stack-on storage height or the two drawer lateral file or storage cabinet plus the bookcase hutch height (66½"H). | H94435 | 355 | 44.4 | \$2871 |
| <i>Doors open 110 degrees from closed position.</i> | | | | | |
|  | Personal Wardrobe/Storage Cabinet (with core removable lock) 37½"W x 24"D x 66½"H NOTES: Spacious design is standard with four adjustable shelves (one shelf is fixed) plus a generous wardrobe section with a coat rod. Shelves adjust in 2½" increments. One lock secures both doors. Unit height is designed to match credenza plus stack-on storage height or the two drawer lateral file or storage cabinet plus the bookcase hutch height (66½"H). Personal wardrobe/storage cabinet is standard with four adjustable shelves (one shelf is fixed) plus a generous wardrobe section with a coat rod. | H94430 | 351 | 44.4 | \$2822 |

NOTES:

- File drawers accommodate letter and legal width side-to-side filing, and letter-width front-to-back filing; use hanging folders with a maximum overall height of 9⅜".
- Adjustable hex leveling glides allow floor-standing furniture to be easily leveled without lifting the unit; glides have ¼" adjustable range.
- For conference table options, see the Preside® table tops and bases in the Tables section in the 2021 Shared Spaces Pricer. Order edge option "T" for 94000 Desks edge compatibility.
- Removable lock core kit – HF23B – allows multiple units to be keyed alike. See page 773.

HOW TO SPECIFY

Select Model Number

H 9 4 2 2 6 .









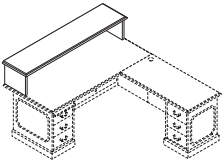

Select Laminate

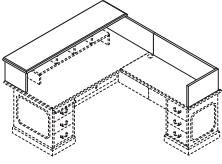
NN Mahogany

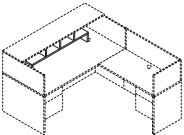
NN

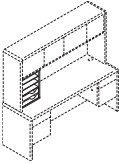

94000 SERIES™ Laminate Wood Desks

| | DESCRIPTION | MODEL | SHIP WEIGHT | CUBE | LIST PRICE |
|---|--|--------------------------------------|--|------------|------------------------------------|
|   | Reception Station/Transaction Counter 71 $\frac{3}{4}$ "W x 16 $\frac{1}{8}$ "D x 14 $\frac{1}{4}$ "H Designed for use with 72"W single pedestal desk models H94285R or H94286L. NOTES: Reception station/transaction counter has traditional-styled decorative molding on the approach side. | H94720 | 75 | 2.6 | \$1024 |
|  Model H94721R shown  | Reception Station for an "L" Workstation 71 $\frac{3}{4}$ "W x 82 $\frac{3}{4}$ "D x 14 $\frac{1}{4}$ "H Designed for use with 72"W single pedestal desk H94286L and 48"W return H94215R (shown) Designed for use with 72"W single pedestal desk H94285R and 48"W return H94216L. NOTES: Reception station for "L" workstation includes components for both the reception/transaction counter for desk and the reception station for return. | H94721R H94722L | 100 | 4.0 | \$1242 \$1242 |
|   | Transaction Counter Organizer 48 $\frac{3}{4}$ "W x 11 $\frac{1}{8}$ "D x 13"H Fits under Transaction Counter on models H94720, H94721R and H94722L. NOTES: Transaction Counter Organizer model HTCOL52 fits under/inside of transaction counter.  Black only. SPECIFYING EXAMPLE: HTCOL52.P | HTCOL52 | 24 | 1.1 | \$300 |
|  Not available in two-tone laminate | Vertical Paper Manager 14 $\frac{7}{8}$ "W x 10 $\frac{7}{8}$ "D x 19 $\frac{1}{16}$ "H NOTES: Keeps papers, files, and books neatly organized and within easy reach from a seated position. Designed for desk, credenza, and return tops. Fits under stack-on storage models. Two pullout drawers and three fixed shelves. NOTES: For additional information see the Workplace Tools section in the 2021 Shared Spaces Pricer. SPECIFYING EXAMPLE: HLVPM1.N | HLVPM1 | 27 | 2.8 | \$351 |
|  Refer to page 104 for Center Drawer compatibility information | Angled Wood Center Drawer 26" x 15 $\frac{5}{8}$ " 22" x 15 $\frac{5}{8}$ " NOTES: Specify laminate. For additional information see the Workplace Tools section in the 2021 Shared Spaces Pricer. SPECIFYING EXAMPLE: H1526.N | H1526 H1522 | 12  11  | 1.2 1.1 | \$214 \$199 |

NOTES:

- For conference table options, see the Preside® table tops and bases in the Tables section in the 2021 Shared Spaces Pricer. Order edge option "T" for 94000 Desks edge compatibility.

HOW TO SPECIFY

| | |
|---|---------------------------------------|
| Select Model Number H 9 4 7 2 0 . | Select Laminate NN Mahogany |
|---|---------------------------------------|

94000 SERIES™ Accessories

GSA SIN AS NOTED



Icon Legend on page 19

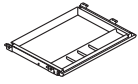

OPEN MARKET

DESCRIPTION

Polymer Center Drawer

- Color: Black.
- Material: ABS.
- Minimum clearance for mounting: 23"W x 16¼"D x 2"H.
- Retracts on 16" ball-bearing slides.
- Can be used on worksurfaces with Coordinate™ Height Adjustable Bases as long as it is attached with spacer model HKBS.
- Can store up to 25 lbs.

! Black finish only, no specification needed.

MODEL SHIP WEIGHT CUBE LIST PRICE

HCD1 7.0 0.5 \$126



Refer to the Workplace Tools section in the 2021 Shared Spaces Pricer for additional product information

- Slide-Away Keyboard Platform** (Specify: Laminate) **H4022**
- Extended Tray Slide-Away Keyboard Platform** (Specify: Laminate) **HE4022**

10.0 \$ 0.6 \$228
12.0 \$ 0.7 \$323

NOTES: For additional information see the Workplace Tools section in the 2021 Shared Spaces Pricer.

SIN 33721

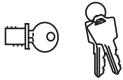

SIN 33721



Black Removable Lock Core Kit (for laminate products)

HF23B 0.1 \$ 0.1 \$35

- Specify quantity of each key number from 101E-225E.
- Includes: 1-core, 2-keys, 1-core removal tool, and instructions.

NOTES: If key number isn't specified, number will be at random. Core matches manufactured lock on laminate product but can be used with metal casegoods product.

NOTES:

- For conference table options, see the Preside® table tops and bases in the Tables section in the 2021 Shared Spaces Pricer. Order edge option "T" for 94000 Desks edge compatibility.

HOW TO SPECIFY

Select Model Number



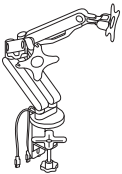

| | DESCRIPTION | MODEL | SHIP WEIGHT | CUBE | LIST PRICE |
|---|--|-----------------|-------------|------|--------------|
|  | <p>Coordinate™ Portable Desktop Riser 31"D x 5"-16½"H x 35"W</p> <p>NOTES: Available in Black (BLK) or White (WHT) finish. Desktop riser dimensions (without keyboard tray): 22"D x 5"-16½"H x 35"W. Keyboard tray dimensions: 9"D x 30"W. Max loading capacity is 33 lbs for the desktop riser surface and 4 lbs for the keyboard tray. Easily transition from seated to standing positions throughout the workday. Sits atop an existing desk to create sit-to-stand functionality by raising the computer. Includes keyboard tray and surface for computer monitors. HON 5-Year Limited Warranty.</p> <p>⚠ Not intended for use on mobile workstations.</p> | HBXRISER | 54.0 | 4.1 | \$657 |
|  | <p>Dual Monitor Arm with 2 USB Ports</p> <p>NOTES: Easy adjustment. Height adjusts to 17" tall. Monitor tilt and swivel capability. Enclosed cable management. Grommet or desktop mounting. Clean appearance. In some applications the Monitor Arms may extend 12 or more inches into the worksurface. For additional information see the Workplace Tools section in the 2021 Shared Spaces Pricer. HON 5-Year Limited Warranty.</p> <p>⚠ No specification needed.</p> | HBDMAUSB | 41.9 | 2.6 | \$410 |

HOW TO SPECIFY

| | |
|--|---|
| <p>Select Model Number</p> <p>HBXRISER.</p> | <p>Select Finish</p> <p>BLK Black WHT White</p> <p>BLK</p> |
|--|---|

94000 SERIES™ Accessories

OPEN MARKET



Icon Legend on page 19

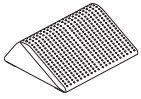

DESCRIPTION

Footrest — Anti-Slip Cover
13¾"D x 5½"H x 16"W

ⓘ Available in Black (T) finish ONLY. Recommended weight capacity not to exceed 250 pounds. **HON 5-Year Limited Warranty.**
SPECIFYING EXAMPLE: HVL991.T

MODEL

SHIP WEIGHT

CUBE

LIST PRICE

HVL991

7 ⓘ

0.9

\$89

HOW TO SPECIFY

Select Model Number

Select Finish

T Black

H V L 9 9 1 .

T



Mentor® Double Pedestal Desk with Volt® Task Chair and Brigade® Bookcases.

MENTOR®

Users appreciate the clean lines and rounded corners of the Mentor desk from HON. Stylish detailing and soft edges create an attractive, contemporary desk that's very user-friendly. Performance and durability make Mentor ideal for use in intensive environments. Featuring central locking drawers and integrated wire management, Mentor works hard for hard-working professionals.



FEATURES

- Durable baked enamel finish will hold up beautifully under years of daily use.
- Functional features like central locking center drawers and integrated wire management.
- Sturdy steel construction and heavy-duty reinforced frames.
- Mentor's performance and durability make it ideal for intensive use environments.
- Half-round legs and radius top corners are excellent for high-traffic areas.
- Arch drawer handles match Flagship® laterals, pedestals and towers.

MENTOR[®] ORDERING INFORMATION

FINISHES AVAILABILITY

L1 LAMINATES CODES

Woodgrain

| | |
|--------------------------|------|
| ◆ Bourbon Cherry | H |
| ◆ Cognac | COGN |
| ◆ Florence Walnut | LFW1 |
| ◆ Harvest | C |
| ◆ Kingswood Walnut | LK11 |
| ◆ Mahogany | N |
| ◆ Mocha | MOCH |
| ◆ Natural Maple | D |
| ◆ Shaker Cherry | F |
| ◆ Sterling Ash | LSA1 |

Solid

| | |
|------------------------|------|
| ◆ Black | P |
| ◆ Charcoal | S |
| ◆ Designer White | LDW1 |
| ◆ Loft | LOFT |

Patterned

| | |
|---------------------------|------|
| ◆ Handspun Chestnut | LAHC |
| ◆ Handspun Dove | LAHD |
| ◆ Handspun Pearl | LAHP |
| ◆ Handspun Slate | LAHS |
| ◆ Sheer Mesh * | A5 |
| ◆ Silver Mesh | B9 |
| ◆ Steel Mesh * | A9 |
| ◆ Canyon Zephyr * | K9 |
| ◆ Desert Zephyr * | K8 |
| ◆ Shadow Zephyr * | K1 |
| ◆ Gray | G2 |
| ◆ Grey Tigris * | L6 |
| ◆ White | G1 |
| ◆ Whitestone * | K4 |

PAINTS CODES

P1

| | |
|--------------------|------|
| ◆ Black | P |
| ◆ Brownstone | P7D |
| ◆ Charcoal | S |
| ◆ Fossil | P28 |
| ◆ Greige | T5 |
| ◆ Light Gray | Q |
| ◆ Loft | LOFT |
| ◆ Muslin | T3 |
| ◆ Putty | L |
| ◆ Shadow * | SHDW |
| ◆ Titanium | P8T |

NOTE: Vinyl edge and grommets match specified chassis color.

• STEEL DESKS

SPECIFY: Model Number.
Top Laminate
Paint Color

EXAMPLE: H88976.NS

◆◆◆ For lead time information see page 19.

* De-emphasized



Icon Legend on page 19

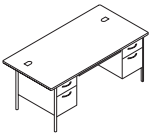
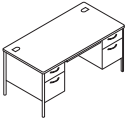
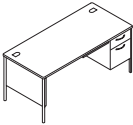
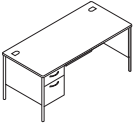
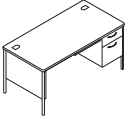
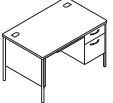

| | DESCRIPTION | MODEL | SHIP WEIGHT | CUBE | LIST PRICE |
|---|--|----------------|-------------|------|---------------|
|  | Double Pedestal Desk with Center Drawer (6" overhang on 3 sides) — 2/2 72"W x 36"D x 29½"H, Chrome Leg and Pull NOTES: Model H88976 requires Model H386560N 60"W Stack-on as top of desk extends over end panels. | H88976 | 203 | 37.7 | \$1987 |
|  | Double Pedestal Desk with Center Drawer — 2/2 60"W x 30"D x 29½"H, Chrome Leg and Pull | H88962 | 178 | 26.7 | \$1647 |
|  | Single Pedestal Desk with Center Drawer – Right, box/file 66"W x 30"D x 29½"H, Chrome Leg and Pull | H88265R | 162 | 29.2 | \$1495 |
|  | Single Pedestal Desk with Center Drawer – Left, box/file 66"W x 30"D x 29½"H, Chrome Leg and Pull | H88266L | 162 | 29.2 | \$1495 |
|  | Single Pedestal Desk with Center Drawer – Right, box/file 60"W x 30"D x 29½"H, Chrome Leg and Pull | H88263R | 145 | 26.7 | \$1420 |
|  | Single Pedestal Desk with Center Drawer – Right, box/file 48"W x 30"D x 29½"H, Chrome Leg and Pull | H88251R | 130 | 21.6 | \$1346 |

NOTES:

- Leg available in Chrome.
- Attractive radius leg design and arched drawer pulls.
- Legs ship unattached.
- 3/4 height modesty panels.
- Rounded edge desk top with soft feel-vinyl edge.
- Wire management grommets in desk tops and pedestals.
- Laminate tops are constructed of 1½" thick particleboard.
- 13½" deep, central locking center drawer equipped with HON "One Key" interchangeable lock cores.
- High-sided file drawers accept hanging files without hangrails.
- Full extension steel ball-bearing suspensions on file drawers for easy access to all contents.
- Reinforced double "O" frame inner structure keeps desk solid and sturdy for years of use.
- Box drawers equipped with 3/4 extension steel ball-bearing suspensions and one divider.
- Vinyl edge and grommets match specified chassis color.
- All interior drawer bodies are gray, pre-painted steel.

ⓘ Keyed alike cores must be ordered separately — see page 773.

HOW TO SPECIFY



| | | |
|---|---|--|
| Select Model Number  | Select Laminate See page 374  | Select Paint Color See page 374  |
|---|---|--|

MENTOR® Steel Desks

GSA SIN 33721



Icon Legend on page 19

| | DESCRIPTION | MODEL | SHIP WEIGHT | CUBE | LIST PRICE |
|--|--|----------------|-------------|------|---------------|
|  | Double Pedestal Credenza with Kneespace, box/file (non-locking) 60"W x 24"D x 29½"H, Chrome Leg and Pull | H88231 | 149 | 21.8 | \$1625 |
|  | Return, Right, box/file (non-locking) 42"W x 24"D x 29½"H, Chrome Leg and Pull | H88235R | 92 | 15.5 | \$1046 |
|  | Return, Left, box/file (non-locking) 42"W x 24"D x 29½"H, Chrome Leg and Pull | H88236L | 92 | 15.5 | \$1046 |

NOTES:

- Leg available in Chrome.
- Attractive radius leg design and arched drawer pulls.
- Legs ship unattached.
- ¾ height modesty panels.
- Rounded edge desk top with soft feel-vinyl edge.
- Wire management grommets in desk tops and pedestals.
- Laminate tops are constructed of 1/8" thick particleboard.
- High-sided file drawers accept hanging files without hangrails.
- Full extension steel ball-bearing suspensions on file drawers for easy access to all contents.
- Reinforced double "O" frame inner structure keeps desk solid and sturdy for years of use.
- Box drawers equipped with ¾ extension steel ball-bearing suspensions and one divider.
- Vinyl edge and grommets match specified chassis color.
- All interior drawer bodies are gray, pre-painted steel.

HOW TO SPECIFY

Select
Model Number

H 8 8 2 3 1 .

Select
Laminate

See page 374

N .

Select
Paint Color

See page 374

S

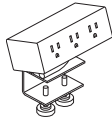

Model HPWRMOD3WC shown

DESCRIPTION**Power Modules**

3 Receptacles with Worksurface Clamp
2 Receptacles 2 USB with Worksurface Clamp

- 6' power cord with standard three-prong plug.
- Under-worksurface mounting bracket models work with any top that has a 5" x 5" square clearance.
- Worksurface clamp models work on any top with a 4" overhang.
- UL Listed.

NOTES: For additional information see the Workplace Tools section in the 2021 Shared Spaces Pricer.

- ! Color finish coordinates with HON's Charcoal or White. Specify *STRM* for Storm or *SNW* for Snow when ordering. Example: *HPWRMOD3WC.STRM*.

MODEL**SHIP WEIGHT****CUBE****LIST PRICE****HPWRMOD3WC**2.3 **Ⓞ**

0.2

\$342**HPWRMOD2WC**2.3 **Ⓞ**

0.2

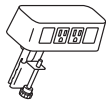
\$546**Power & Data Center**

2 Receptacles 2 Data Accessory

- Standard with two receptacles and openings for two data ports.
- 6' power cord with standard three-prong plug.
- Fits on any worksurface with a 4" overhang.
- UL Listed.

NOTES: For additional information see the Workplace Tools section in the 2021 Shared Spaces Pricer.

- ! Color finish coordinates with HON's Loft. Specify *LOFT* when ordering. Example: *HCOMDOME2.LOFT*.

HCOMDOME22.5 **Ⓞ**

0.2

\$327**Vertebrae**

NOTES: 30"H x 3 1/8"W x 1 1/2"D. Ships unassembled. For additional information see the Workplace Tools section in the 2021 Shared Spaces Pricer.

- ! Clear finish. Specify "X" for finish option.

SPECIFYING EXAMPLE: HMPVWM28.X**HMPVWM28**

3.0

0.3

\$246**Storage Cube**

12"W x 12"D

SPECIFYING EXAMPLE: HLSL1212.P8S**HLSL1212**

1.0

0.3

\$316**HOW TO SPECIFY**

Select
Model Number

H P W R M O D 3 W C



DESCRIPTION

MODEL

SHIP WEIGHT

CUBE

LIST PRICE

Coordinate™ Portable Desktop Riser
31"D x 5"-16½"H x 35"W

HBXRISER

54.0

4.1

\$657

NOTES: Available in Black (BLK) or White (WHT) finish. Desktop riser dimensions (without keyboard tray): 22"D x 5"-16½"H x 35"W. Keyboard tray dimensions: 9"D x 30"W. Max loading capacity is 33 lbs for the desktop riser surface and 4 lbs for the keyboard tray. Easily transition from seated to standing positions throughout the workday. Sits atop an existing desk to create sit-to-stand functionality by raising the computer. Includes keyboard tray and surface for computer monitors. **HON 5-Year Limited Warranty.**

⚠ Not intended for use on mobile workstations.

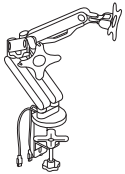

Dual Monitor Arm with 2 USB Ports

HBDMAUSB

41.9

2.6

\$410

NOTES: Easy adjustment. Height adjusts to 17" tall. Monitor tilt and swivel capability. Enclosed cable management. Grommet or desktop mounting. Clean appearance. In some applications the Monitor Arms may extend 12 or more inches into the worksurface. For additional information see the Workplace Tools section in the 2021 Shared Spaces Pricer. **HON 5-Year Limited Warranty.**

⚠ No specification needed.

HOW TO SPECIFY

Select Model Number

Select Finish

BLK Black
WHT White

HBXRISER.

BLK

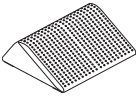

Icon Legend on page 19

| | DESCRIPTION | MODEL | SHIP WEIGHT | CUBE | LIST PRICE |
|---|---|----------------------|-------------|------------|--------------------|
|  | <p>Footrest — Anti-Slip Cover 13³/₄"D x 5¹/₂"H x 16"W</p> <p>ⓘ Available in Black (T) finish ONLY. Recommended weight capacity not to exceed 250 pounds. HON 5-Year Limited Warranty. SPECIFYING EXAMPLE: HVL991.T</p> | <p>HVL991</p> | <p>7 Ⓢ</p> | <p>0.9</p> | <p>\$89</p> |

HOW TO SPECIFY

| | |
|---|--|
| <p>Select Model Number</p> <p>H V L 9 9 1 .</p> | <p>Select Finish</p> <p>T Black</p> <p>T</p> |
|---|--|

METRO CLASSIC

Want to see more? Scan here
to check out hon.com.



Metro Classic Desk shown with Ignition® Seating.

METRO CLASSIC

The Metro Classic is a forward-thinking flashback that marries '60s styling with today's technology. This handsomely built collection offers excellent performance for the price — with best-in-class construction, easy-care laminate tops, built-in wire management and more. If you're looking for iconic style that lasts, you'll find it in Metro Classic.



FEATURES

- Retro-styled, but with up-to-date amenities, this classic reflects the enduring Modernist office designs of the 1960s.
- With tubular steel legs painted to match the desk body, Metro Classic gives you a clean look from top to bottom.
- Pedestals feature Tru-Fit mitered drawer fronts for precision alignment when closed.
- Contract-grade, multi-ply laminate stands up to scratches, spills, stains and boiling liquids.
- Recessed plastic drawer handles are color-matched to HON core paint colors.
- All drawers lock by securing the center drawer; lock core can be changed as security needs require.

METRO CLASSIC ORDERING INFORMATION

FINISHES AVAILABILITY

L1 LAMINATES/EDGE BAND

COLOR CODES

Woodgrain

- ◆ Bourbon Cherry/
Bourbon Cherry H
- ◆ Cognac/Cognac COGN
- ◆ Florence Walnut/
Florence Walnut LFW1
- ◆ Harvest/Harvest C
- ◆ Kingswood Walnut/
Kingswood Walnut LK11
- ◆ Mahogany/Mahogany N
- ◆ Mocha/Mocha MOCH
- ◆ Natural Maple/
Natural Maple D
- ◆ Pinnacle/Pinnacle PINC
- ◆ Shaker Cherry/
Shaker Cherry F
- ◆ Sterling Ash/
Sterling Ash LSA1

Solid

- ◆ Black/Black P
- ◆ Charcoal/Charcoal S
- ◆ Designer White/
Designer White LDW1
- ◆ Loft/Loft LOFT

Patterned

- ◆ Handspun Chestnut LAHC
- ◆ Handspun Dove LAHD
- ◆ Handspun Pearl LAHP
- ◆ Handspun Slate LAHS
- ◆ Sheer Mesh * /Muslin A5
- ◆ Silver Mesh/Loft B9
- ◆ Steel Mesh * /Charcoal A9
- ◇ Canyon Zephyr * /
Greige K9
- ◇ Desert Zephyr * /
Greige K8
- ◇ Shadow Zephyr * /
Loft K1
- ◆ Gray/Matches Paint Color G2
- ◆ Grey Tigris * /Greige L6
- ◇ White/Matches Paint
Color G1
- ◆ Whitestone * /Matches Paint
Color K4

PAINTS CODES

P1

- ◆ Black P
- ◆ Brownstone P7D
- ◆ Charcoal S
- ◆ Fossil P28
- ◆ Greige T5
- ◆ Light Gray Q
- ◆ Loft LOFT
- ◆ Muslin T3
- ◆ Putty L
- ◆ Shadow * SHDW
- ◆ Titanium P8T

• STEEL DESKS

SPECIFY: Model Number.
Top Laminate
Paint Color

EXAMPLE: HP3276.NS

◆◆◆ For lead time information see page 19.

* De-emphasized



METRO CLASSIC

Steel Desks

GSA SIN 33721

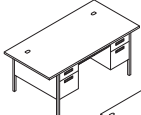
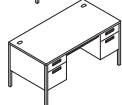
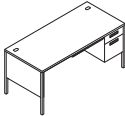

Icon Legend on page 19

| | DESCRIPTION | MODEL | SHIP WEIGHT | CUBE | LIST PRICE |
|---|---|----------------|-------------|------|---------------|
|  HP3276  HP3262 | Double Pedestal — 2/2 (locking) 72"W x 36"D x 29½"H (6" overhang on 3 sides) NOTES: HP3276 requires Model H386560N 60"W Stack-on as top of desk extends over end panels. | HP3276 | 218 | 37.7 | \$1907 |
| | 60"W x 30"D x 29½"H (Non-Locking, 24"D chassis) (6" overhang on approach side only) | HP3261 | 165 | 26.7 | \$1337 |
| | 60"W x 30"D x 29½"H (locking) | HP3262 | 186 | 26.7 | \$1559 |
|  | Single Pedestal (locking) 66"W x 30"D x 29½"H — 2R 66"W x 30"D x 29½"H — 2L | HP3265R | 167 | 29.2 | \$1440 |
| | | HP3266L | 167 | 29.2 | \$1440 |
| | 48"W x 30"D x 29½"H — 2R | HP3251R | 142 | 21.6 | \$1283 |
|  | Return, Right — box/file (non-locking) 42"W x 24"D x 29½"H | HP3235R | 95 | 15.5 | \$1007 |
|  | Return, Left — box/file (non-locking) 42"W x 24"D x 29½"H | HP3236L | 95 | 15.5 | \$1007 |

NOTES:

- Two wire grommets in desk, credenza, and return tops.
- 3/4 height modesty panels.
- Legs shipped unattached.
- Color of pulls and grommets match paint selection for core colors.
- "Tru-fit" mitered drawer fronts for better visual alignment.
- Color of legs match paint selection.
- Central locking center drawer standard, with HON "One Key" interchangeable lock cores.
- High-sided file drawers accept hanging files without hangrails.
- Full extension steel ball-bearing suspensions on file drawers for easy access to all contents.
- Box drawers equipped with 3/4 extension steel ball-bearing suspensions.
- Reinforced, double "O" frame inner structure keeps desk solid and sturdy for years of use.
- All interior drawer bodies are gray pre-painted steel.
- 38000 Series™ stack-on units can be used on Metro desks and credenzas.

! Keyed alike cores ordered separately — see page 773.

HOW TO SPECIFY**Select Model Number**

HP3276

Select Laminate

See page 381
 Not specified for models H386566N, H386560N and H386548N

N

Select Paint Color

See page 381



S



Icon Legend on page 19

METRO CLASSIC

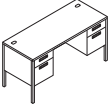
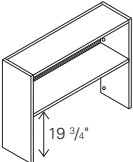
Steel Desks

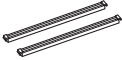
| | DESCRIPTION | MODEL | SHIP WEIGHT | CUBE | LIST PRICE |
|---|--|---|----------------------|-------------------|--|
|  | Credenza w/Kneespace — 2/2 (non-locking) 60"W x 24"D x 29½"H Accommodates optional HD2 or HD8 center drawer. NOTES: Non-locking. | HP3231 | 165.0 | 21.8 | \$1559 |
|  | Stack-on Full Clearance without Doors 66"W x 13½"D x 34¾"H 60"W x 13½"D x 34¾"H 48"W x 13½"D x 34¾"H NOTES: Interior is 12¾"H. Specify: Paint color. For additional 38000 Series™ Stack-on accessory items, see pages 405-407. HP3276 requires Model H386560N 60"W Stack-on as top of desk extends over end panels. | H386566N H386560N H386548N | 68.0 64.0 53.0 | 6.3 5.7 4.7 | \$981 \$908 \$829 |
|  | Chrome Leg Packs — Field Installable 4 pk-29½"H | HC14 | 7.2 | 0.2 | \$149 |
|  | Double-Rail Hanging File Racks — 2 Pack (for side-to-side) ⓘ Gray only | H519495 | 0.5 | 0.5 | \$39 |

NOTES:

- Two wire grommets in desk, credenza, and return tops.
- ¾ height modesty panels.
- Legs shipped unattached.
- Color of pulls and grommets match paint selection for core colors.
- "Tru-fit" mitered drawer fronts for better visual alignment.
- Color of legs match paint selection.
- Central locking center drawer standard, with HON "One Key" interchangeable lock cores.
- High-sided file drawers accept hanging files without hangrails.
- Full extension steel ball-bearing suspensions on file drawers for easy access to all contents.
- Box drawers equipped with ¾ extension steel ball-bearing suspensions.
- Reinforced, double "O" frame inner structure keeps desk solid and sturdy for years of use.
- All interior drawer bodies are gray pre-painted steel.
- 38000 Series™ stack-on units can be used on Metro desks and credenzas.

ⓘ Keyed alike cores ordered separately — see page 773.

HOW TO SPECIFY

| | | |
|--|---|--|
| Select Model Number HP3231 | Select Laminate See page 381 Not specified for models H386566N, H386560N and H386548N N | Select Paint Color See page 381 S |
|--|---|--|

METRO CLASSIC

Accessories

GSA SIN 33721

ABI

Icon Legend on page 19

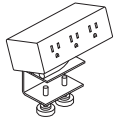

Model HPWRMOD3WC shown

DESCRIPTION

Power Modules

3 Receptacles with Worksurface Clamp

MODEL

HPWRMOD3WC

SHIP WEIGHT

2.3 Ⓢ

CUBE

0.2

LIST PRICE

\$342

2 Receptacles 2 USB with Worksurface Clamp

HPWRMOD2WC

2.3 Ⓢ

0.2

\$546

- 6' power cord with standard three-prong plug.

- Under-worksurface mounting bracket models work with any top that has a 5" x 5" square clearance.

- Worksurface clamp models work on any top with a 4" overhang.

- UL Listed.

ⓘ Color finish coordinates with HON's Charcoal or White. Specify *STRM* for Storm or *SNW* for Snow when ordering.

Example: HPWRMOD3WC.STRM.

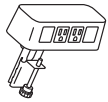

Power & Data Center

2 Receptacles 2 Data Accessory

HCOMDOME2

2.5 Ⓢ

0.2

\$327

- Standard with two receptacles and openings for two data ports.

- 6' power cord with standard three-prong plug.

- Fits on any worksurface with a 4" overhang.

- UL Listed.

ⓘ Color finish coordinates with HON's Loft. Specify *LOFT* when ordering. Example: HCOMDOME2.LOFT.



Vertebrae

HMPVWM28

3.0

0.3

\$246

NOTES: 30"H x 3 1/8"W x 1 1/2"D. Ships unassembled.

ⓘ Clear finish. Specify "X" for finish option.

SPECIFYING EXAMPLE: HMPVWM28.X



Storage Cube

12"W x 12"D

HLSL1212

1.0

0.3

\$316

SPECIFYING EXAMPLE: HLSL1212.P8S



HOW TO SPECIFY

Select
Model Number

H P W R M O D 3 W C



Icon Legend on page 19

METRO CLASSIC Accessories

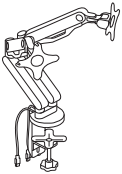
| | DESCRIPTION | MODEL | SHIP WEIGHT | CUBE | LIST PRICE |
|---|--|-----------------|-------------|------|--------------|
|  | <p>Coordinate™ Portable Desktop Riser 31"D x 5"-16½"H x 35"W</p> <p>NOTES: Available in Black (BLK) or White (WHT) finish. Desktop riser dimensions (without keyboard tray): 22"D x 5"-16½"H x 35"W. Keyboard tray dimensions: 9"D x 30"W. Max loading capacity is 33 lbs for the desktop riser surface and 4 lbs for the keyboard tray. Easily transition from seated to standing positions throughout the workday. Sits atop an existing desk to create sit-to-stand functionality by raising the computer. Includes keyboard tray and surface for computer monitors. HON 5-Year Limited Warranty.</p> <p>⚠ Not intended for use on mobile workstations.</p> | HBXRISER | 54.0 | 4.1 | \$657 |
|  | <p>Dual Monitor Arm with 2 USB Ports</p> <p>NOTES: Easy adjustment. Height adjusts to 17" tall. Monitor tilt and swivel capability. Enclosed cable management. Grommet or desktop mounting. Clean appearance. In some applications the Monitor Arms may extend 12 or more inches into the worksurface. For additional information see the Workplace Tools section in the 2021 Shared Spaces Pricer. HON 5-Year Limited Warranty.</p> <p>⚠ No specification needed.</p> | HBDMAUSB | 41.9 | 2.6 | \$410 |

HOW TO SPECIFY

| | |
|--|---|
| <p>Select Model Number</p> <p>H B X R I S E R .</p> | <p>Select Finish</p> <p>BLK Black WHT White</p> <p>B L K</p> |
|--|---|

METRO CLASSIC

Accessories

OPEN MARKET



Icon Legend on page 19

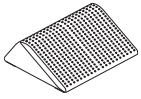

DESCRIPTION

Footrest — Anti-Slip Cover
13¾"D x 5½"H x 16"W

ⓘ Available in Black (T) finish ONLY. Recommended weight capacity not to exceed 250 pounds. **HON 5-Year Limited Warranty.**
SPECIFYING EXAMPLE: HVL991.T

MODEL

HVL991

SHIP WEIGHT

7 ⓘ

CUBE

0.9

LIST PRICE

\$89

HOW TO SPECIFY

Select Model Number

Select Finish

T Black

H V L 9 9 1 .

T

34000 SERIES

Want to see more? Scan here
to check out hon.com.



**34000 Series shown with 500 Series
Lateral and Volt® Seating.**

34000 SERIES

The 34000 Series gets high marks in the classroom — or any environment requiring a heavy-duty metal desk that knows how to look good. The square Chrome legs and brushed Aluminum handles look clean and uncomplicated. The Tru-Fit mitered drawer fronts line up perfectly every time. Desk models offer central locking, so all the drawers can be secured with the turn of a single key. And with HON's best-in-class construction, 34000 Series will stand up to years of use.



FEATURES

- Legs are Chrome for a contemporary accent.
- Pedestals feature Tru-Fit mitered drawer fronts that align precisely when closed.
- All drawers lock by securing the center drawer; lock core can be changed as security needs require.
- Contract-grade, multi-ply laminate worksurface stands up to scratches, spills, stains and boiling liquids.
- Brushed Aluminum drawer handles match HON vertical file handles.

34000 SERIES ORDERING INFORMATION

FINISHES AVAILABILITY

L1 LAMINATES/EDGE BAND

COLOR CODES

Woodgrain

- ◆ Bourbon Cherry/
Bourbon Cherry **H**
- ◆ Cognac/Cognac **COGN**
- ◆ Florence Walnut/
Florence Walnut **LFW1**
- ◆ Harvest/Harvest **C**
- ◆ Kingswood Walnut/
Kingswood Walnut **LK11**
- ◆ Mahogany/Mahogany **N**
- ◆ Mocha/Mocha **MOCH**
- ◆ Natural Maple/
Natural Maple **D**
- ◆ Shaker Cherry/
Shaker Cherry **F**
- ◆ Sterling Ash/
Sterling Ash **LSA1**

Solid

- ◆ Black/Black **P**
- ◆ Charcoal/Charcoal **S**
- ◆ Designer White/
Designer White **LDW1**
- ◆ Loft/Loft **LOFT**

Patterned

- ◆ Handspun Chestnut **LAHC**
- ◆ Handspun Dove **LAHD**
- ◆ Handspun Pearl **LAHP**
- ◆ Handspun Slate **LAHS**
- ◆ Sheer Mesh * /Muslin **A5**
- ◆ Silver Mesh /Loft **B9**
- ◆ Steel Mesh * /Charcoal **A9**
- ◆ Canyon Zephyr * /Greige **K9**
- ◆ Desert Zephyr * /Greige **K8**
- ◆ Shadow Zephyr * /Loft **K1**
- ◆ Gray/Matches Paint Color **G2**
- ◆ Grey Tigris/Grey Tigris * **L6**
- ◆ White/Matches Paint
Color **G1**
- ◆ Whitestone * /Matches Paint
Color **K4**

PAINTS CODES

P1

- ◆ Black **P**
- ◆ Brownstone **P7D**
- ◆ Charcoal **S**
- ◆ Fossil **P28**
- ◆ Greige **T5**
- ◆ Light Gray **Q**
- ◆ Loft **LOFT**
- ◆ Muslin **T3**
- ◆ Putty **L**
- ◆ Shadow * **SHDW**
- ◆ Titanium **P8T**

• STEEL DESKS

*SPECIFY: Model Number.
Top Laminate
Paint Color*









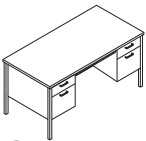

EXAMPLE: HP3276.NS

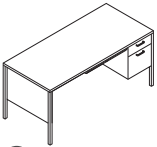
◆◆◆ For lead time information see page 19.

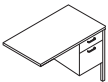
* De-emphasized

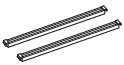

34000 SERIES Steel Desks

| | DESCRIPTION | MODEL | SHIP WEIGHT | CUBE | LIST PRICE |
|---|--|---|---|------------------------------|---|
|  | Double Pedestal — 2/2 (locking) 60"W x 30"D x 29½"H | H34962 | 162.0 | 26.7 | \$1487 |
|  | | | | | |
|  | Single Pedestal, box/file (locking) 66"W x 30"D x 29½"H, Right 66"W x 30"D x 29½"H, Left 48"W x 30"D x 29½"H, Right 45¼"W x 24"D x 29½"H, Right | H34973R H34974L H34251 H34002R | 161.0 161.0 115.0 83.0 | 29.2 29.2 21.6 16.6 | \$1284 \$1284 \$1134 \$969 |
|  | | | | | |
|  | Return, Box/File (non-locking) 42"W x 24"D x 29½"H, Right 42"W x 24"D x 29½"H, Left | H34834R H34835L | 89.0 89.0 | 15.5 15.5 | \$854 \$854 |
|  | NOTES: Returns are for use with 66"W Single Pedestal Desks. | | | | |
|  | Credenza with Kneespace — 2/2 (non-locking) 60"W x 24"D x 29½"H | H34480 | 160.0 | 21.8 | \$1494 |
|  | ! Accommodates optional HD2 or HD8 center drawer. | | | | |
|  | Chrome Leg Packs — Field Installable 4 pk-29½"H | HC14 | 7.2  | 0.2 | \$149 |
|  | Double-Rail Hanging File Racks — 2 Pack (for side-to-side) ! Gray only | H519495 | 0.5 | 0.5 | \$39 |

NOTES:

- "Tru-fit" mitered drawer fronts for better visual alignment.
- 3/4 height modesty panels.
- Chrome legs shipped unattached.
- Laminate tops.
- Central locking center drawer standard, with HON "One Key" interchangeable lock cores.
- Full extension steel ball-bearing suspensions on file drawers for easy access to all contents.
- High-sided file drawers accept hanging files without hangrails.
- Box drawers equipped with 3/4 extension steel ball-bearing suspensions and one divider.
- Reinforced, double "O" frame inner structure keeps desk solid and sturdy for years of use.
- All interior drawer bodies are gray, pre-painted steel.
- ! Keyed alike cores ordered separately — see page 773.

HOW TO SPECIFY

| | | |
|----------------------------|--|---|
| Select Model Number | Select Laminate See page 388 | Select Paint Color See page 388 |
| H 3 4 9 6 2 | N | S |

34000 SERIES

Accessories

GSA SIN 33721

ABI

Icon Legend on page 19

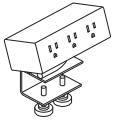

Model HPWRMOD3WC shown

DESCRIPTION**Power Modules**

3 Receptacles with Worksurface Clamp

MODEL**SHIP WEIGHT****CUBE****LIST PRICE**

2 Receptacles 2 USB with Worksurface Clamp

HPWRMOD3WC

2.3

0.2

\$342**HPWRMOD2WC**

2.3

0.2

\$546

- 6' power cord with standard three-prong plug.

- Under-worksurface mounting bracket models work with any top that has a 5" x 5" square clearance.

- Worksurface clamp models work on any top with a 4" overhang.

- UL Listed.

NOTES: For additional information see the Workplace Tools section in the 2021 Shared Spaces Pricer.

Color finish coordinates with HON's Charcoal or White. Specify *STRM* for Storm or *SNW* for Snow when ordering. Example: HPWRMOD3WC.STRM.

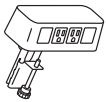
**Power & Data Center**

2 Receptacles 2 Data Accessory

HCOMDOME2

2.5

0.2

\$327

- Standard with two receptacles and openings for two data ports.

- 6' power cord with standard three-prong plug.

- Fits on any worksurface with a 4" overhang.

- UL Listed.

NOTES: For additional information see the Workplace Tools section in the 2021 Shared Spaces Pricer.

Color finish coordinates with HON's Loft. Specify *LOFT* when ordering. Example: HCOMDOME2.LOFT.

**Vertebrae****HMPVWM28**

3.0

0.3

\$246

NOTES: 30"H x 3 1/8"W x 1 1/2"D. Ships unassembled. For additional information see the Workplace Tools section in the 2021 Shared Spaces Pricer.

Clear finish. Specify "X" for finish option.

SPECIFYING EXAMPLE: HMPVWM28.X**Storage Cube**

12"W x 12"D

HLSL1212

1.0

0.3

\$316**SPECIFYING EXAMPLE: HLSL1212.P8S****HOW TO SPECIFY**Select
Model Number

H P W R M O D 3 W C

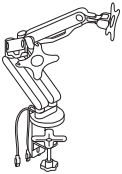

34000 SERIES Accessories

| | DESCRIPTION | MODEL | SHIP WEIGHT | CUBE | LIST PRICE |
|---|--|-----------------|-------------|------|--------------|
|  | <p>Coordinate™ Portable Desktop Riser 31"D x 5"-16½"H x 35"W</p> <p>NOTES: Available in Black (BLK) or White (WHT) finish. Desktop riser dimensions (without keyboard tray): 22"D x 5"-16½"H x 35"W. Keyboard tray dimensions: 9"D x 30"W. Max loading capacity is 33 lbs for the desktop riser surface and 4 lbs for the keyboard tray. Easily transition from seated to standing positions throughout the workday. Sits atop an existing desk to create sit-to-stand functionality by raising the computer. Includes keyboard tray and surface for computer monitors. HON 5-Year Limited Warranty.</p> <p>⚠ Not intended for use on mobile workstations.</p> | HBXRISER | 54.0 | 4.1 | \$657 |
|  | <p>Dual Monitor Arm with 2 USB Ports</p> <p>NOTES: Easy adjustment. Height adjusts to 17" tall. Monitor tilt and swivel capability. Enclosed cable management. Grommet or desktop mounting. Clean appearance. In some applications the Monitor Arms may extend 12 or more inches into the worksurface. For additional information see the Workplace Tools section in the 2021 Shared Spaces Pricer. HON 5-Year Limited Warranty.</p> <p>⚠ No specification needed.</p> | HBDMAUSB | 41.9 | 2.6 | \$410 |

HOW TO SPECIFY

| | |
|--|---|
| <p>Select Model Number</p> <p>H B X R I S E R .</p> | <p>Select Finish</p> <p>BLK Black WHT White</p> <p>B L K</p> |
|--|---|

34000 SERIES Accessories

OPEN MARKET



Icon Legend on page 19

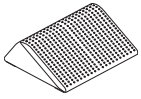

DESCRIPTION

Footrest — Anti-Slip Cover
13¾"D x 5½"H x 16"W

ⓘ Available in Black (T) finish ONLY. Recommended weight capacity not to exceed 250 pounds. **HON 5-Year Limited Warranty.**
SPECIFYING EXAMPLE: HVL991.T

MODEL

HVL991

SHIP WEIGHT

7 ⓘ

CUBE

0.9

LIST PRICE

\$89

HOW TO SPECIFY

Select Model Number

H V L 9 9 1 .

Select Finish

T Black

T

38000 SERIES™

Want to see more? Scan here
to check out hon.com.



38000 Series™ Station shown with Solve® Seating.

38000 SERIES™

The 38000 Series is America's best-selling steel desk — and with good reason. Rugged good looks. Precision engineering. Best-in-class construction. This modular collection blends designer touches like stylish, high-pressure laminate with useful details like cord-management. Which makes the 38000 Series the ideal desk solution for any organization seeking premium performance for a moderate price.



FEATURES

- Our steel construction is best in class — so it stands up to heavy use and frequent relocation.
- Integrated wire management and optional power hub accommodate today's electronic office.
- Pedestals feature Tru-Fit mitered drawer fronts for precision alignment when closed.
- Curved, waterfall-shaped edge profile provides a comfortable typing surface.
- Premium, multi-ply laminate worksurface stands up to scratches, spills and stains, and holds up under heavy use.
- Steel ball-bearing drawer suspensions operate easily and quietly.
- Cord management provides access to wall outlets, and allows cords to run through the or between components.

38000 SERIES™ ORDERING INFORMATION

FINISHES AVAILABILITY

L1 LAMINATES/EDGE BAND

COLOR CODES

Woodgrain

- ◆ Bourbon Cherry/
Bourbon Cherry **H**
- ◆ Cognac/Cognac **COGN**
- ◆ Florence Walnut/
Florence Walnut **LFW1**
- ◆ Harvest/Harvest **C**
- ◆ Kingswood Walnut/
Kingswood Walnut **LK11**
- ◆ Mahogany/Mahogany **N**
- ◆ Mocha/Mocha **MOCH**
- ◆ Natural Maple/
Natural Maple **D**
- ◆ Pinnacle/Pinnacle **PINC**
- ◆ Shaker Cherry/
Shaker Cherry **F**
- ◆ Sterling Ash/
Sterling Ash **LSA1**

Solid

- ◆ Black/Black **P**
- ◆ Charcoal/Charcoal **S**
- ◆ Designer White/
Designer White **LDW1**
- ◆ Loft/Loft **LOFT**

Patterned

- ◆ Handspun Chestnut **LAHC**
- ◆ Handspun Dove **LAHD**
- ◆ Handspun Pearl **LAHP**
- ◆ Handspun Slate **LAHS**
- ◆ Sheer Mesh * /Muslin **A5**
- ◆ Silver Mesh/Loft **B9**
- ◆ Steel Mesh * /Charcoal **A9**
- ◆ Canyon Zephyr * /
Greige **K9**
- ◆ Desert Zephyr * /
Greige **K8**
- ◆ Shadow Zephyr * /
Loft **K1**
- ◆ Gray/Matches Paint Color **G2**
- ◆ Grey Tigris * /Greige **L6**
- ◆ White/Matches Paint Color .. **G1**
- ◆ Whitestone * /Matches Paint
Color **K4**

FINISHES AVAILABILITY *continued*

PAINTS CODES

P1

- ◆ Black **P**
- ◆ Brownstone **P7D**
- ◆ Charcoal **S**
- ◆ Designer White **PJW**
- ◆ Fossil **P28**
- ◆ Greige **T5**
- ◆ Light Gray **Q**
- ◆ Loft **LOFT**
- ◆ Muslin **T3**
- ◆ Putty **L**
- ◆ Shadow * **SHDW**
- ◆ Titanium **P8T**

P2

- ◆ Champagne Metallic **T4**
- ◆ Platinum Metallic **T1**

NOTE: Where 38000 edgeband does not match laminate color, alternative color is on flat edges only (sides, sides and back edge on returns and bridges, flat sides of corner unit, and flat end of peninsulas).

• STEEL DESKS

SPECIFY: Model Number.
Top Laminate
Paint Color

EXAMPLE: H38934.NS

• 38000 TACKBOARDS

(Fabric listed on pages 25-26)

SPECIFY: Model Number
Fabric Style.
Color Code
Paint Color

EXAMPLE: HT72.CE18.P

◆◆◆ For lead time information see page 19.

* De-emphasized



Icon Legend on page 19

38000 SERIES™ Typicals — 3/4 Height Pedestals

Components used are listed on pages 399-407. Order components individually. Other configurations are possible, including various sizes of some components.

| QTY | DESCRIPTION | MODEL | LIST PRICE | PRICE EXTENSION |
|-----|---|--------|------------|-----------------|
| 1 | Double Pedestal Desk 72"W x 36"D x 29½"H | H38180 | \$2,196 | \$2,196 |
| 1 | Credenza with Kneespace 72"W x 24"D x 29½"H | H38854 | \$1,906 | \$1,906 |

TOTAL: \$4,102

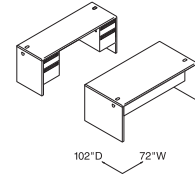

DESK WORKSTATION WITH CREDEZA
72"W x 102"D

| QTY | DESCRIPTION | MODEL | LIST PRICE | PRICE EXTENSION |
|-----|--|----------|------------|-----------------|
| 1 | Single Pedestal Desk 72"W x 36"D x 29½"H | H38293R | \$1,958 | \$1,958 |
| 1 | Stack-on Storage w/o Doors 72½"W x 13½"D x 34¾"H | H386572N | \$1,034 | \$1,034 |
| 1 | Bridge 48"W x 24"D x 37⅞"H | H38210 | \$661 | \$661 |
| 1 | Flipper Doors 2@36"W x 15"H | H387215 | \$643 | \$643 |
| 1 | Single Pedestal Credenza 72"W x 24"D x 29½"H | H38855L | \$1,625 | \$1,625 |

TOTAL: \$5,921

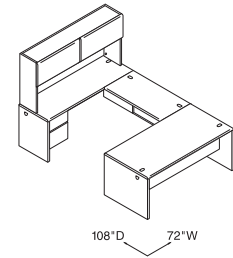

DESK "U" WORKSTATION
72"W x 108"D

| QTY | DESCRIPTION | MODEL | LIST PRICE | PRICE EXTENSION |
|-----|--|----------|------------|-----------------|
| 1 | Single Pedestal Desk 72"W x 36"D x 29½"H | H38293R | \$1,958 | \$1,958 |
| 1 | Stack-on Storage w/o Doors 72½"W x 13½"D x 34¾"H | H386572N | \$1,034 | \$1,034 |
| 1 | Left, Return, box/file 60"W x 24"D x 29½"H | H38218L | \$1,301 | \$1,301 |
| 1 | Flipper Doors 2@36"W x 15"H | H387215 | \$643 | \$643 |

TOTAL: \$4,936

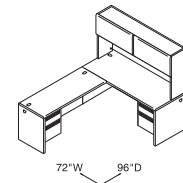

DESK "L" WORKSTATION
72"W x 96"D

| QTY | DESCRIPTION | MODEL | LIST PRICE | PRICE EXTENSION |
|-----|--|----------|------------|-----------------|
| 1 | Peninsula with Full End Panel 70"W x 36"D x 29½"H | H38941E | \$1,530 | \$1,530 |
| 1 | Stack-on Storage w/o Doors 72½"W x 13½"D x 34¾"H | H386572N | \$1,034 | \$1,034 |
| 1 | Bridge 42"W x 24"D x 29½"H | H38220 | \$628 | \$628 |
| 1 | Flipper Doors 2@36"W x 15"H | H387215 | \$643 | \$643 |
| 1 | Single Pedestal Credenza, Left 72"W x 24"D x 29½"H | H38855L | \$1,625 | \$1,625 |

TOTAL: \$5,460

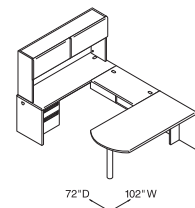

PENINSULA "U" WORKSTATION
72"W x 102"D

38000 SERIES™

Typicals — Modular



Icon Legend on page 19

Components used are listed on pages 399-407. Order components individually. Other configurations are possible, including various sizes of some components.

| QTY | DESCRIPTION | MODEL | LIST PRICE | PRICE EXTENSION |
|---------------|--|---------|----------------|-----------------|
| 1 | Shell Desk 72"W x 36"D x 29½"H | H38934 | \$1,332 | \$1,332 |
| 1 | Flagship Mobile Pedestal – file/file 15"W x 22⅞"D x 28"H | H18823R | \$851 | \$851 |
| 1 | Return Shell, Left 48"W x 24"D x 29½"H | H38944L | \$928 | \$928 |
| 1 | Standard Height Mobile Pedestal – box/box/file 15"W x 16⅞"D x 28"H | H18717R | \$790 | \$790 |
| TOTAL: | | | \$3,901 | |

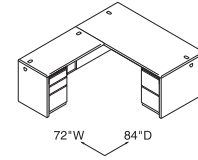

MODULAR DESK WORKSTATION
84"W x 72"D

| QTY | DESCRIPTION | MODEL | LIST PRICE | PRICE EXTENSION |
|---------------|--|----------|----------------|-----------------|
| 1 | Shell Desk 72"W x 36"D x 29½"H | H38934 | \$1,332 | \$1,332 |
| 1 | Flagship Mobile Pedestal – file/file 15"W x 22⅞"D x 28"H | H18823R | \$851 | \$851 |
| 1 | Bridge 48"W x 24"D x 29½"H | H38210 | \$661 | \$661 |
| 1 | Shell Desk 72"W x 24"D x 29½"H | H38925 | \$1,288 | \$1,288 |
| 1 | Standard Height Mobile Pedestal – box/box/file 15"W x 16⅞"D x 28"H | H18717R | \$790 | \$790 |
| 1 | Stack-on Storage w/o Doors 72⅝"W x 13½"D x 34¾"H | H386572N | \$1,034 | \$1,034 |
| TOTAL: | | | \$5,956 | |

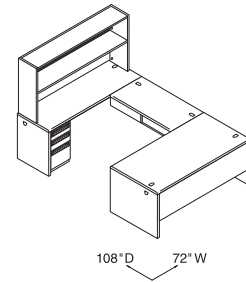

MODULAR DESK "U" WORKSTATION
72"W x 108"D

| QTY | DESCRIPTION | MODEL | LIST PRICE | PRICE EXTENSION |
|---------------|--|----------|----------------|-----------------|
| 1 | Corner Unit | H38928 | \$1,496 | \$1,496 |
| 1 | Peninsula with End Panel 70"W x 36"D x 29½"H | H38941E | \$1,530 | \$1,530 |
| 1 | Bridge 42"W x 24"D x 29½"H | H38220 | \$628 | \$628 |
| 1 | Shell Return, Right 72"W x 24"D x 29½"H | H38947R | \$1,236 | \$1,236 |
| 1 | Flagship Lateral File 30"W x 18"D x 28"H | H9170R | \$1,116 | \$1,116 |
| 1 | Stack-on Storage w/o Doors 72⅝"W x 13½"D x 34¾"H | H386572N | \$1,034 | \$1,034 |
| 1 | Flipper Doors 2@36"W x 15"H | H387215 | \$643 | \$643 |
| TOTAL: | | | \$7,683 | |

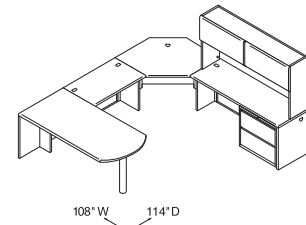

PENINSULA "U" WORKSTATION
108"W x 114"D

| QTY | DESCRIPTION | MODEL | LIST PRICE | PRICE EXTENSION |
|---------------|--|----------|----------------|-----------------|
| 1 | Corner Unit | H38928 | \$1,496 | \$1,496 |
| 1 | Shell Return, Left 72"W x 24"D x 29½"H | H38948L | \$1,236 | \$1,236 |
| 1 | Standard Height Mobile Pedestal – box/box/file 15"W x 16⅞"D x 28"H | H18717R | \$790 | \$790 |
| 1 | Stack-on Storage w/o Doors 72⅝"W x 13½"D x 34¾"H | H386572N | \$1,034 | \$1,034 |
| 1 | Flipper Doors 2@36"W x 15"H | H387215 | \$643 | \$643 |
| 1 | Shell Return – Right 72"W x 24"D x 29½"H | H38947R | \$1,236 | \$1,236 |
| 1 | Standard Height Mobile Pedestal – file/file 15"W x 16⅞"D x 28"H | H18817R | \$790 | \$790 |
| TOTAL: | | | \$7,225 | |

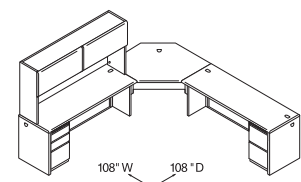

CORNER UNIT WITH RETURNS WORKSTATION
108"W x 108"D



Icon Legend on page 19

38000 SERIES™ Bundles Typicals

Mahogany/Charcoal
H38LL7284NS

Harvest/Putty
H38LL7284CL

| QTY | DESCRIPTION | MODEL | LIST PRICE | PRICE EXTENSION |
|---------------|--------------------|---------|----------------|-----------------|
| 1 | Left Pedestal Desk | H38294L | \$1,958 | \$1,958 |
| 1 | Right Return | H38215R | \$1,186 | \$1,186 |
| TOTAL: | | | \$3,144 | |

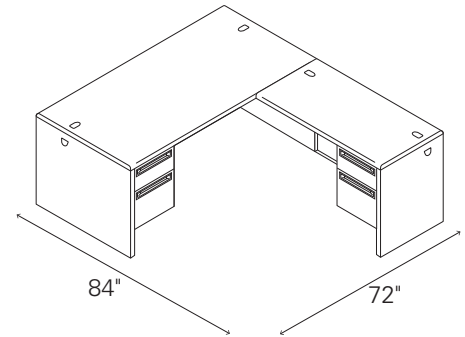

L-STATION (LEFT DESK/RIGHT RETURN)

Mahogany/Charcoal
H38LR7284NS

Harvest/Putty
H38LR7284CL

| QTY | DESCRIPTION | MODEL | LIST PRICE | PRICE EXTENSION |
|---------------|---------------------|---------|----------------|-----------------|
| 1 | Right Pedestal Desk | H38293R | \$1,958 | \$1,958 |
| 1 | Left Return | H38216L | \$1,186 | \$1,186 |
| TOTAL: | | | \$3,144 | |

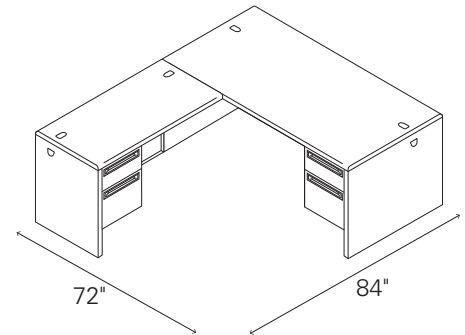

L-STATION (RIGHT DESK/LEFT RETURN)

Mahogany/Charcoal
H38URH72108NS2

Harvest/Putty
H38URH72108CL2

| QTY | DESCRIPTION | MODEL | LIST PRICE | PRICE EXTENSION |
|---------------|--------------------------------|----------|----------------|-----------------|
| 1 | Single Pedestal Desk, Right | H38293R | \$1,958 | \$1,958 |
| 1 | Single Pedestal Credenza, Left | H38855L | \$1,625 | \$1,625 |
| 1 | Hutch without Doors | H386572N | \$1,034 | \$1,034 |
| 1 | Flipper Doors, Pair | H387215 | \$643 | \$643 |
| 1 | Bridge | H38210 | \$661 | \$661 |
| TOTAL: | | | \$5,921 | |

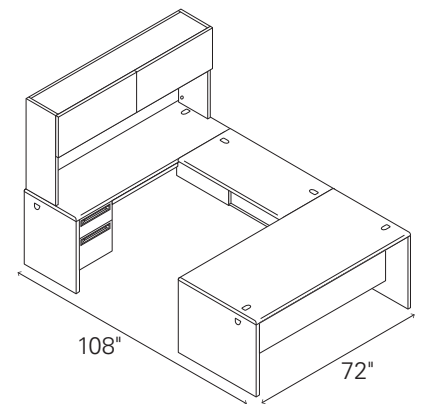

**U-STATION WITH HUTCH
(RIGHT DESK/LEFT CREDENZA)**

38000 SERIES™

Bundles Typicals



Icon Legend on page 19

Mahogany/Charcoal
H38ULH72108NS2

Harvest/Putty
H38ULH72108CL2

| QTY | DESCRIPTION | MODEL | LIST PRICE | PRICE EXTENSION |
|---------------|---------------------------------|-----------------|----------------|-----------------|
| 1 | Single Pedestal Desk, Left | H38294L | \$1,958 | \$1,958 |
| 1 | Single Pedestal Credenza, Right | H38856R | \$1,625 | \$1,625 |
| 1 | Hutch without Doors | H386572N | \$1,034 | \$1,034 |
| 1 | Flipper Doors, Pair | H387215 | \$643 | \$643 |
| 1 | Bridge | H38210 | \$661 | \$661 |
| TOTAL: | | | \$5,921 | |

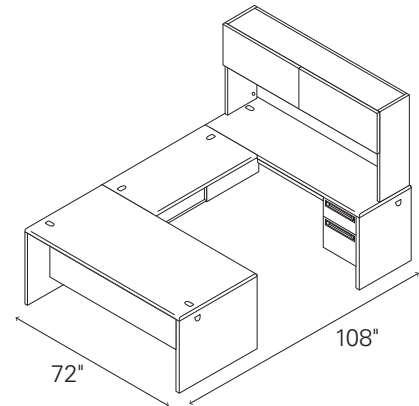

**U-STATION WITH HUTCH
(LEFT DESK/RIGHT CREDENZA)**

Mahogany/Charcoal
H38DCH6096NS2

Harvest/Putty
H38DCH6096CL2

| QTY | DESCRIPTION | MODEL | LIST PRICE | PRICE EXTENSION |
|---------------|--------------------------|-----------------|----------------|-----------------|
| 1 | Double Pedestal Desk | H38155 | \$1,878 | \$1,878 |
| 1 | Double Pedestal Credenza | H38852 | \$1,833 | \$1,833 |
| 1 | Hutch without Doors | H386560N | \$908 | \$908 |
| 1 | Flipper Doors, Pair | H386015 | \$605 | \$605 |
| TOTAL: | | | \$5,224 | |

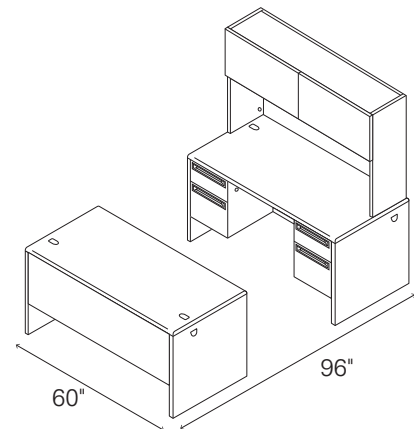



WORKSTATION



38000 SERIES™

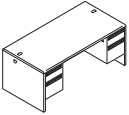
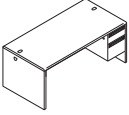

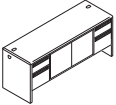
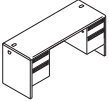
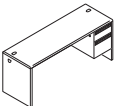
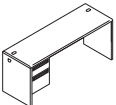
Steel Desks — 3/4 Pedestals

| | DESCRIPTION | FULL WIDTH OVERHANG | MODEL | SHIP WEIGHT | CUBE | LIST PRICE BY PAINT GRADE | | |
|---|---|---------------------|----------------|-------------|---------------|---------------------------|---------------|---------------|
| | | | | | | P1 | P2 | P3 |
|  | Double Pedestal — 2/2 w/Locks | | | | | | | |
| | 72"W x 36"D x 29½"H | 6" | H38180 | 256 | 51.7 | \$2196 | \$2270 | \$2341 |
| | 66"W x 30"D x 29½"H | | H38170 | 224 | 40.1 | \$2102 | \$2176 | \$2247 |
| | 60"W x 30"D x 29½"H | | H38155 | 217 | 36.6 | \$1878 | \$1952 | \$2023 |
|  | Single Pedestal w/Lock | | | | | | | |
| | 72"W x 36"D x 29½"H — 2R | 6" | H38293R | 214 | 51.7 | \$1958 | \$2032 | \$2103 |
| | 66"W x 30"D x 29½"H — 2R | | H38291R | 181 | 40.1 | \$1804 | \$1878 | \$1949 |
| | 48"W x 30"D x 29½"H — 2R | | H38251 | 155 | 29.6 | \$1597 | \$1671 | \$1742 |
| | 72"W x 36"D x 29½"H — 2L | 6" | H38294L | 214 | 51.7 | \$1958 | \$2032 | \$2103 |
| | 66"W x 30"D x 29½"H — 2L | | H38292L | 181 | 40.1 | \$1804 | \$1878 | \$1949 |
| | 48"W x 30"D x 29½"H — 2L | | H38252L | 155 | 29.6 | \$1597 | \$1671 | \$1742 |
|  | Flush Return — box/file w/Lock | | | | | | | |
| | 60"W x 24"D x 29½"H — 2R | | H38217R | 138 | 30.1 | \$1301 | \$1346 | \$1390 |
| | 48"W x 24"D x 29½"H — 2R | | H38215R | 124 | 24.1 | \$1186 | \$1231 | \$1275 |
| | 60"W x 24"D x 29½"H — 2L | | H38218L | 138 | 30.1 | \$1301 | \$1346 | \$1390 |
| | 48"W x 24"D x 29½"H — 2L | | H38216L | 124 | 24.1 | \$1186 | \$1231 | \$1275 |
| | NOTES: Returns have 2 grommets each in worksurface top and full height modesty panel. | | | | | | | |
|  | Credenza w/Doors w/Locks | | | | | | | |
| 72"W x 24"D x 29½"H | | H38853 | 230 | 35.6 | \$2072 | \$2146 | \$2217 | |
| | NOTES: Pedestals lock. | | | | | | | |
|  | Credenza w/Kneespace w/Locks | | | | | | | |
| | 72"W x 24"D x 29½"H | | H38854 | 172 | 35.6 | \$1906 | \$1980 | \$2051 |
| | Kneespace: 39¾"W | | | | | | | |
| | 66"W x 24"D x 29½"H | | H38851 | 166 | 32.7 | \$1866 | \$1940 | \$2011 |
| | Kneespace: 33¾"W | | | | | | | |
| | 60"W x 24"D x 29½"H | | H38852 | 154 | 29.8 | \$1833 | \$1907 | \$1978 |
| | Kneespace: 27¾"W | | | | | | | |
| | NOTES: Pedestals lock. | | | | | | | |
|  | Single Pedestal Credenza — 2R w/Lock | | | | | | | |
| | 72"W x 24"D x 29½"H | | H38856R | 159 | 35.6 | \$1625 | \$1699 | \$1770 |
| | 66"W x 24"D x 29½"H | | H38858R | 153 | 32.7 | \$1507 | \$1581 | \$1652 |
| | NOTES: Pedestal locks. | | | | | | | |
|  | Single Pedestal Credenza — 2L w/Lock | | | | | | | |
| | 72"W x 24"D x 29½"H | | H38855L | 159 | 35.6 | \$1625 | \$1699 | \$1770 |
| | 66"W x 24"D x 29½"H | | H38857L | 153 | 32.7 | \$1507 | \$1581 | \$1652 |
| | NOTES: Pedestal locks. | | | | | | | |

NOTES:

- 3/4 height modesty panels unless noted.
- Color of pulls and grommets match paint selection for core colors.
- One pencil tray standard per unit except returns.
- Laminate particleboard tops feature attractive, radius edges on front and rear edges of desks. Returns and bridges have radius front and flat rear edge to match the side edge it attaches to.
- Wire grommets standard in all tops.
- Wire grommets in end panels allow cable connections between desks.
- "Tru-fit" mitered drawer fronts for better visual alignment.
- Optional center drawer features steel ball-bearing suspension.
- High-sided file drawers accept hanging files without hangrails.
- Three-part full extension steel ball-bearing suspension on all file drawers for full access to interior contents.
- Box drawers feature two-part, ¾" extension steel ball-bearing suspension.
- Baked enamel finish over rust-inhibiting phosphate pre-treatment.
- See page 401 for 38000 Series™ shared components.
- Optional follower block accessory available to organize drawer storage.

HOW TO SPECIFY

| | | |
|---|---|--|
| Select Model Number  | Select Laminate See page 394  | Select Paint Color See page 394  |
|---|---|--|

38000 SERIES™ Modular Desks

GSA SIN 33721



Icon Legend on page 19

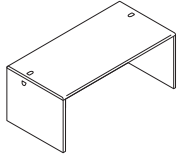

| DESCRIPTION | INSIDE SHELL DIMENSIONS | FULL WIDTH OVERHANG | MODEL | SHIP WEIGHT | CUBE | LIST PRICE BY PAINT GRADE | | |
|---------------------|-------------------------|---------------------|---------------|-------------|------|---------------------------|---------------|---------------|
| | | | | | | P1 | P2 | P3 |
| Desk Shell | | | | | | | | |
| 72"W x 36"D x 29½"H | 69½"W x 28¾"D | 6" | H38934 | 134 | 7.1 | \$1332 | \$1406 | \$1477 |
| 72"W x 30"D x 29½"H | 69½"W x 28¾"D | | H38935 | 118 | 6.0 | \$1297 | \$1371 | \$1442 |
| 66"W x 30"D x 29½"H | 63½"W x 28¾"D | | H38933 | 108 | 6.0 | \$1278 | \$1352 | \$1423 |
| 60"W x 30"D x 29½"H | 57½"W x 28¾"D | | H38932 | 103 | 5.1 | \$1215 | \$1289 | \$1360 |
| 48"W x 30"D x 29½"H | 45½"W x 28¾"D | | H38931 | 89 | 5.1 | \$1123 | \$1197 | \$1268 |
| 72"W x 24"D x 29½"H | 69½"W x 22¾"D | | H38925 | 99 | 5.0 | \$1288 | \$1362 | \$1433 |
| 66"W x 24"D x 29½"H | 63½"W x 22¾"D | | H38923 | 95 | 5.0 | \$1234 | \$1308 | \$1379 |
| 60"W x 24"D x 29½"H | 57½"W x 22¾"D | | H38922 | 89 | 4.2 | \$1174 | \$1248 | \$1319 |
| 48"W x 24"D x 29½"H | 45½"W x 22¾"D | | H38921 | 83 | 4.2 | \$1099 | \$1173 | \$1244 |

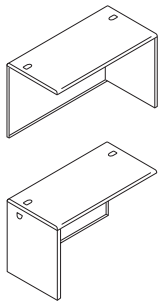

| | | | | | | | | |
|----------------------------|----------------------------|--|----------------|----|-----|---------------|---------------|---------------|
| Return Shell | | | | | | | | |
| 72"W x 24"D x 29½"H, Right | 69½"W x 22¾"D (2 grommets) | | H38947R | 87 | 6.0 | \$1236 | \$1281 | \$1325 |
| 60"W x 24"D x 29½"H, Right | 57½"W x 22¾"D (2 grommets) | | H38945R | 80 | 5.1 | \$1108 | \$1153 | \$1197 |
| 48"W x 24"D x 29½"H, Right | 45½"W x 22¾"D (2 grommets) | | H38943R | 71 | 4.2 | \$928 | \$973 | \$1017 |
| 42"W x 24"D x 29½"H, Right | 39½"W x 22¾"D (2 grommets) | | H38949R | 65 | 4.2 | \$865 | \$910 | \$954 |
| 72"W x 24"D x 29½"H, Left | 69½"W x 22¾"D (2 grommets) | | H38948L | 87 | 6.0 | \$1236 | \$1281 | \$1325 |
| 60"W x 24"D x 29½"H, Left | 57½"W x 22¾"D (2 grommets) | | H38946L | 80 | 5.1 | \$1108 | \$1153 | \$1197 |
| 48"W x 24"D x 29½"H, Left | 45½"W x 22¾"D (2 grommets) | | H38944L | 71 | 4.2 | \$928 | \$973 | \$1017 |
| 42"W x 24"D x 29½"H, Left | 39½"W x 22¾"D (2 grommets) | | H38950L | 65 | 4.2 | \$865 | \$910 | \$954 |

NOTES: Modular returns feature full height modesty panels.

ⓘ Not designed to be used freestanding.

NOTES:

- 38000 Series™ Modular Desks offers designer styling, configuration flexibility and storage versatility.
- Create both individual managerial stations and task-oriented work areas.
- Designed with adaptability for today's electronic office.
- Color of pulls and grommets match paint selection for core colors. If Titanium paint is selected then Loft is provided.
- Wire grommets standard in all tops, except peninsulas.
- Wire grommets in end panels allow cable connections between desks.
- Optional center drawer features steel ball-bearing suspension.
- For components that can be shared with 38000 Series™, see page 401.
- 3/4 height modesty panels unless noted.
- Ability to use all HON laterals and pedestals.

Recommended Pedestal Options:

| 38000 Series™ | 36" Deep Desk | | | 30" Deep Desk | | | 24" Deep Desk | | |
|---|-------------------|--------------------------|-------------------------|-------------------|--------------------------|-------------------------|-------------------|--------------------------|-------------------------|
| Contain®, Flagship® or Brigade® Pedestals | Ability to Attach | Ability to Use Wire Port | Ability to Attach Hutch | Ability to Attach | Ability to Use Wire Port | Ability to Attach Hutch | Ability to Attach | Ability to Use Wire Port | Ability to Attach Hutch |
| 16¾"D Hanging Pedestal | • | • | • | • | • | • | • | • | • |
| 22⅞"D Hanging Pedestal | • | • | • | • | • | • | • | • | • |
| 16¾"D Freestanding or Mobile | • | • | • | • | • | • | • | • | • |
| 22⅞"D Freestanding or Mobile | • | • | • | • | • | • | • | • | • |
| 28⅞"D Freestanding or Mobile | • | • | • | • | • | • | • | • | • |

Use of a pedestal spacer or 28"H standard height pedestals will block wire access from the grommet to the kneespace area.

NOTES: Stack-on units can be attached regardless of pedestal configuration.

Personalize Your Storage Needs**With These Possible Solutions:**

Use coordinating HON components such as Pedestals shown on page 707 and Lateral Files shown on pages 657-661 and 709-710.

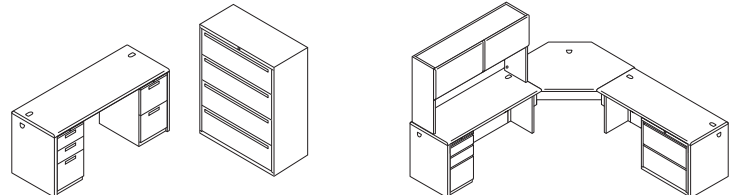
**HOW TO SPECIFY**

| | | |
|---|---|--|
| Select Model Number H 3 8 9 3 4 . | Select Laminate See page 394 N . | Select Paint Color See page 394 S . |
|---|---|--|



Icon Legend on page 19

38000 SERIES™ Shared Components and Accessories

| | DESCRIPTION | MODEL | SHIP WEIGHT | CUBE | LIST PRICE BY PAINT GRADE | | | |
|--|---|--|-------------------------|-------------------|---|---|---|---------------|
| | | | | | P1 | P2 | P3 | |
| | Peninsula with Support Column and End Panel 70"W x 36"D x 29½"H 70"W x 30"D x 29½"H 66"W x 30"D x 29½"H | H38941E H38942E H38966E | 132.0 126.0 113.0 | 8.1 7.0 8.1 | \$1530 \$1453 \$1413 | \$1575 \$1498 \$1458 | \$1619 \$1542 \$1502 | |
| | NOTES: Use to create "L" configuration with a Return or "U" configuration with a Bridge and Credenza, Desk or Corner Unit. ⓘ Not designed to be used freestanding. | | | | | | | |
| | | Corner Unit 24" x 36" x 36" x 24" x 29½"H Leading edge is 17"W; leading edge to rear edge is 36"D. | | H38928 | 85.0 | 7.4 | \$1496 | \$1570 |
| ⓘ Designed to be used with Returns or Bridges. | | | | | | | | |
| | Bridge 48"W x 24"D x 29½"H 42"W x 24"D x 29½"H | H38210 H38220 | 54.0 ⓘ 50.0 ⓘ | 4.2 4.2 | \$661 \$628 | \$679 \$646 | \$694 \$661 | |
| | NOTES: Full height modesty panel. | | | | | | | |
| | Metal Center Drawers with core removable locks 24¾"W x 14¾"D for H38180, H38170, H38155 19"W x 14¾"D for H38293R, H38294L, H38291R, H38292L | HD8 HD2 | 12.0 ⓘ 9.0 ⓘ | 1.2 1.0 | \$297 \$297 | \$307 \$307 | \$315 \$315 | |
| | NOTES: For additional information see the Workplace Tools section in the 2021 Shared Spaces Pricer. Specify: Paint color. | | | | | | | |
| | Polymer Center Drawer | HCD1 | 7.0 | 0.5 | \$126 | | | |
| | <ul style="list-style-type: none"> • Color: Black. • Material: ABS. • Minimum clearance for mounting: 23"W x 16¼"D x 2"H. • Retracts on 16" ball-bearing slides. • Can be used on worksurfaces with Coordinate™ Height Adjustable Bases as long as it is attached with spacer model HKBS. • Can store up to 25 lbs. ⓘ Black finish only, no specification needed. | | | | | | | |
| | Corner Sleeve — Square Edge 22½" leading edge x 18"D | H51206 | 10.0 ⓘ | 1.5 | \$171 | \$181 | \$188 | |
| | NOTES: For additional information see the Workplace Tools section in the 2021 Shared Spaces Pricer. Specify: Paint color. | | | | | | | |
| | Slide-Away Keyboard Platform (Specify: Laminate) | H4022 | 10.0 ⓘ | 0.6 | \$228 | | | |
| | Metal Keyboard and Mouse Tray (Specify paint) | H4028 | 11.0 ⓘ | 1.5 | \$164 | \$174 | | |
| | Metal Keyboard Tray (Specify paint) | H4029 | 11.0 ⓘ | 1.5 | \$148 | \$158 | | |
| | NOTES: For additional information see the Workplace Tools section in the 2021 Shared Spaces Pricer. | | | | | | | |
| | Double-Rail Hanging File Racks — 2 Pack (for side-to-side) | H519495 | 0.5 | 0.5 | \$39 | | | |
| | | | | | | | | |

- NOTES:**
- Full end panel legs have neat, contemporary appearance.
 - 3/4 height modesty panels unless noted.
 - Our broadest selection of components, including components for "U" and "L" workstation arrangements.
 - All worksurfaces shown are particleboard.
 - Color of grommets match paint selection for core colors.
 - 38000 Series™ Stack-on units and accessories listed on pages 401-407.

HOW TO SPECIFY

| | | | |
|---|---|--|--|
| Select Model Number H 3 8 9 4 1 E . | Select Laminate See page 394 N . | Select Paint Color See page 394 S . | Select Support Column Paint Specify for new peninsula models only P Black |
|---|---|--|--|

38000 SERIES™

Accessories

GSA SIN 33721

ABI

Icon Legend on page 19

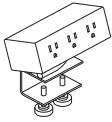

Model HPWRMOD3WC shown

DESCRIPTION**Power Modules**

3 Receptacles with Worksurface Clamp

2 Receptacles 2 USB with Worksurface Clamp

- 6' power cord with standard three-prong plug.

- Under-worksurface mounting bracket models work with any top that has a 5" x 5" square clearance.

- Worksurface clamp models work on any top with a 4" overhang.

- UL Listed.

NOTES: For additional information see the Workplace Tools section in the 2021 Shared Spaces Pricer.

! Color finish coordinates with HON's Charcoal or White. Specify *STRM* for Storm or *SNW* for Snow when ordering.
Example: HPWRMOD3WC.STRM.

MODEL**SHIP WEIGHT****CUBE****LIST PRICE****HPWRMOD3WC**

2.3 Ⓢ

0.2

\$342**HPWRMOD2WC**

2.3 Ⓢ

0.2

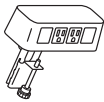
\$546**Power & Data Center**

2 Receptacles 2 Data Accessory

- Standard with two receptacles and openings for two data ports.

- 6' power cord with standard three-prong plug.

- Fits on any worksurface with a 4" overhang.

- UL Listed.

NOTES: For additional information see the Workplace Tools section in the 2021 Shared Spaces Pricer.

! Color finish coordinates with HON's Loft. Specify *LOFT* when ordering. Example: HCOMDOME2.LOFT.

HCOMDOME2

2.5 Ⓢ

0.2

\$327**Vertebrae**

NOTES: 30"H x 3 1/8"W x 1 1/2"D. Ships unassembled. For additional information see the Workplace Tools section in the 2021 Shared Spaces Pricer.

! Clear finish. Specify "X" for finish option.

SPECIFYING EXAMPLE: HMPVWM28.X**HMPVWM28**

3.0

0.3

\$246**Storage Cube**

12"W x 12"D

SPECIFYING EXAMPLE: HLSL1212.P8S**HLSL1212**

1.0

0.3

\$316**HOW TO SPECIFY**

Select
Model Number

H P W R M O D 3 W C

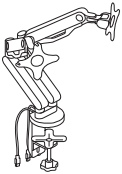

| | DESCRIPTION | MODEL | SHIP WEIGHT | CUBE | LIST PRICE |
|---|--|-----------------|-------------|------|--------------|
|  | <p>Coordinate™ Portable Desktop Riser 31"D x 5"-16½"H x 35"W</p> <p>NOTES: Available in Black (BLK) or White (WHT) finish. Desktop riser dimensions (without keyboard tray): 22"D x 5"-16½"H x 35"W. Keyboard tray dimensions: 9"D x 30"W. Max loading capacity is 33 lbs for the desktop riser surface and 4 lbs for the keyboard tray. Easily transition from seated to standing positions throughout the workday. Sits atop an existing desk to create sit-to-stand functionality by raising the computer. Includes keyboard tray and surface for computer monitors. HON 5-Year Limited Warranty.</p> <p>⚠ Not intended for use on mobile workstations.</p> | HBXRISER | 54.0 | 4.1 | \$657 |
|  | <p>Dual Monitor Arm with 2 USB Ports</p> <p>NOTES: Easy adjustment. Height adjusts to 17" tall. Monitor tilt and swivel capability. Enclosed cable management. Grommet or desktop mounting. Clean appearance. In some applications the Monitor Arms may extend 12 or more inches into the worksurface. For additional information see the Workplace Tools section in the 2021 Shared Spaces Pricer. HON 5-Year Limited Warranty.</p> <p>⚠ No specification needed.</p> | HBDMAUSB | 41.9 | 2.6 | \$410 |

HOW TO SPECIFY

| | |
|--|---|
| <p>Select Model Number</p> <p>H B X R I S E R .</p> | <p>Select Finish</p> <p>BLK Black WHT White</p> <p>B L K</p> |
|--|---|

38000 SERIES™ Accessories

OPEN MARKET



Icon Legend on page 19

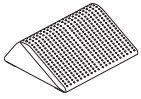

DESCRIPTION

Footrest — Anti-Slip Cover
13¾"D x 5½"H x 16"W

ⓘ Available in Black (T) finish ONLY. Recommended weight capacity not to exceed 250 pounds. **HON 5-Year Limited Warranty.**
SPECIFYING EXAMPLE: HVL991.T

MODEL

HVL991

SHIP WEIGHT

7 ⓘ

CUBE

0.9

LIST PRICE

\$89

HOW TO SPECIFY

Select Model Number

Select Finish

T Black

H V L 9 9 1 .

T



Icon Legend on page 19

38000 SERIES™ Steel Stack-on Units

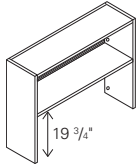

DESCRIPTION

Stack-on Full Clearance without Doors

- 72"W x 13½"D x 34¾"H
- 66"W x 13½"D x 34¾"H
- 60"W x 13½"D x 34¾"H
- 48"W x 13½"D x 34¾"H

NOTES: Interior is 12¾"H.
Specify: Paint color.

| MODEL | SHIP WEIGHT | CUBE | LIST PRICE BY PAINT GRADE | | |
|-----------------|-------------|------|---------------------------|---------------|---------------|
| | | | P1 | P2 | P3 |
| H386572N | 72 | 6.8 | \$1034 | \$1085 | \$1134 |
| H386566N | 68 | 6.3 | \$981 | \$1032 | \$1081 |
| H386560N | 64 | 5.7 | \$908 | \$959 | \$1008 |
| H386548N | 53 | 4.7 | \$829 | \$880 | \$929 |

HOW TO SPECIFY

| | |
|--|---|
| <p>Select Model Number</p> <p>H 3 8 6 5 7 2 N .</p> | <p>Select Paint Color</p> <p>See page 394</p> <p>P</p> |
|--|---|

DESCRIPTION

Front Flipper Doors

- 2 @ 36"W x 15"H, Flipper Doors for 72"W Stack-on
- 2 @ 33"W x 15"H, Flipper Doors for 66"W Stack-on
- 2 @ 30"W x 15"H, Flipper Doors for 60"W Stack-on
- 1 @ 48"W x 15"H, Flipper Door for 48"W Stack-on

Specify: Paint color.

| MODEL | SHIP WEIGHT | CUBE | LIST PRICE BY PAINT GRADE | | |
|----------------|-------------|------|---------------------------|--------------|--------------|
| | | | P1 | P2 | P3 |
| H387215 | 19 | 0.9 | \$643 | \$661 | \$687 |
| H386615 | 17 | 0.9 | \$629 | \$647 | \$673 |
| H386015 | 16 | 0.9 | \$605 | \$623 | \$649 |
| H384815 | 12 | 0.5 | \$368 | \$386 | \$412 |

NOTES:

- Flipper doors are standard with a core removable lock located on the underside of stack-on shelf.
- Many Stack-on sizes available, from 48" to 72" wide.
- Equipped with HON "One Key" interchangeable core removable locks.
- Stack-on units attach to worksurface with double stick tape or with screws provided.
- Stack-ons also compatible with Abode™, Mentor®, Metro Classic, and 66000 Series Computer Furniture.
- Cabinet/door combination kits available for field installation.
- Two dividers standard with every stack-on.
- Color of grommets match paint selection for core colors.

ⓘ Keyed alike cores must be ordered separately — see page 773.

ⓘ Stack-on Units not designed to be used on Corner Units.

HOW TO SPECIFY

| | | |
|--|--|---|
| <p>Select Model Number</p> <p>H 3 8 7 2 1 5 .</p> | <p>Select Lock Option</p> <p>L Lock X Omit Lock (deduct \$20) See page 773 for omit lock ordering instructions</p> <p>L .</p> | <p>Select Paint Color</p> <p>See page 394</p> <p>P</p> |
|--|--|---|

38000 SERIES™ Steel Stack-on Units

GSA SIN 33721



Icon Legend on page 19

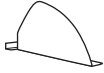

| DESCRIPTION | MODEL | SHIP WEIGHT | CUBE | LIST PRICE BY PAINT GRADE | | |
|---|-----------------|-------------|------|---------------------------|--------------|--------------|
| | | | | P1 | P2 | P3 |
| Shelf Dividers — package of 6 Specify: Paint color. Shelf dividers can only be used on stack-ons manufactured after 7/3/2000. | H38SHFDV | 3 | 0.2 | \$167 | \$178 | \$186 |

HOW TO SPECIFY

| | |
|---|---|
| <p>Select Model Number</p> <p>H 3 8 S H F D V . P</p> | <p>Select Paint Color</p> <p>See page 394</p> |
|---|---|



38000 SERIES™ Accessories

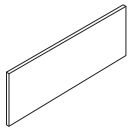

SIN 33721

DESCRIPTION

Tackboard for Stack-on — 20”H
72”W
66”W
60”W
48”W

MODEL

HT72ND
HT66ND
HT60ND
HT48ND

SHIP WEIGHT

26.0
24.0
22.0
18.0

CUBE

2.3
2.1
1.9
1.5

LIST PRICE

\$577
\$555
\$537
\$480

Specify: Model.Fabric.Paint. Upcharges may apply to premium fabric grades.

! Disperse (DISP) fabric not available on sizes wider than 60”.

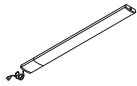

OPEN MARKET

LED Task Lights

17” LED Light with Power Supply (Single)
31” LED Light with Power Supply (Single)

HLED17AS ☉
HLED31AS ☉

1.2 ☹
1.5 ☹

0.05
0.09

\$450
\$603

17” LED Light with Power Supply for Daisy-chain (Starter)
31” LED Light with Power Supply for Daisy-chain (Starter)

HLED17A
HLED31A

1.0 ☹
1.4 ☹

0.05
0.09

\$493
\$662

17” LED Light with 8” Jumper Cord for Daisy-chain (Follower)
31” LED Light with 8” Jumper Cord for Daisy-chain (Follower)

HLED17AUO ☉
HLED31AUO ☉

1.0 ☹
1.0 ☹

0.03
0.05

\$404
\$539

Undercabinet Occupancy Sensor with 1” End to End Connector

HLEDOSA ☉

0.2 ☹

0.01

\$97

NOTES: To use the daisy chain application, must start with model HLED17A or HLED31A. No finish specification required. Attaches magnetically to underside of overhead storage, or attaches with provided screws or double-sided tape. Occupancy sensor attaches to a single or starter LED light and will automatically turn the light off after no motion is detected for 30 minutes. Just like all the LED light models, the occupancy sensor features a soft-touch on/off switch. LED task lights have a lifetime of 50,000 hours and have a dimmer feature that allows the user to adjust the amount of light output.

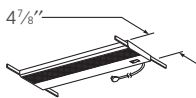

Refer to the Workplace Tools section in the 2021 Shared Spaces Pricer

OPEN MARKET

Recessed Task Light for use under 72”, 66” and 60”W Stack-on or Open Shelf

46½”W x 3¼”D x 1⅞”H

HH870960

12.0 ☹

1.1

\$290

NOTES: For additional information see the Workplace Tools section in the 2021 Shared Spaces Pricer.

Recessed Task Light for use under 48”W Stack-on or Open Shelf

34⅝”W x 3¼”D x 1⅞”H

HH870942

10.0 ☹

0.9

\$267

NOTES: For additional information see the Workplace Tools section in the 2021 Shared Spaces Pricer.



SIN 33721

Articulating Desk Lamp

HLED1

1.2 ☹

6.5

\$430

Articulating Desk Lamp w/ Occupancy Sensor

HLED1OC

1.2 ☹

6.5

\$524

NOTES: For additional information see the Workplace Tools section in the 2021 Shared Spaces Pricer.



SIN 33721

Task Desk Lamp

HLED2

0.7 ☹

3.0

\$373

NOTES: For additional information see the Workplace Tools section in the 2021 Shared Spaces Pricer.

NOTES:

- See specifying information above for Choice/Metallic paint and pages 16 and 394 for Custom Paint ordering instructions.
- Tackboards feature painted steel backs and can be installed in the field.

HOW TO SPECIFY

| | | |
|---|---|---|
| <p>Select Model Number</p> <p>HT72ND</p> | <p>Select Fabric Color</p> <p>See pages 25-26</p> <p>APN15</p> | <p>Select Paint Color</p> <p>See page 394</p> <p>P</p> |
|---|---|---|

NOTES



Abode™ shown with Contain® Storage and Endorse® Seating.

ABODE™

The Abode systems desk gives you a consistent look throughout your space and can help you respond easily to future layout changes. It integrates seamlessly with Abound® and Accelerate®, and can be configured to create freestanding or height adjustable workstations. For greater flexibility and durability in the workspace, look no further than Abode.



FEATURES

- Create a freestanding metal desk that accommodates storage above and below the worksurface.
- Full compatibility with Abound and Accelerate workstations elevates the functionality of Abode.
- Incorporating Coordinate™ makes it easy for workers to adjust their desk height throughout the day, keeping them active, healthy and focused.

ABODE™ ORDERING INFORMATION

WORKSURFACES, COUNTERTOPS, CORNER SHELVES W/EDGE BAND

L1 LAMINATES CODES

Woodgrain

- ◆ Bourbon Cherry H
- ◆ Cognac COGN
- ◆ Florence Walnut LFW1
- ◆ Harvest C
- ◆ Kingswood Walnut LK11
- ◆ Mahogany N
- ◆ Mocha MOCH
- ◆ Natural Maple D
- ◆ Pinnacle PINC
- ◆ Shaker Cherry F
- ◆ Sterling Ash LSA1

Solid

- ◆ Black P
- ◆ Charcoal S
- ◆ Designer White LDW1
- ◆ Loft LOFT

Patterned

- ◆ Handspun Chestnut LAHC
- ◆ Handspun Dove LAHD
- ◆ Handspun Pearl LAHP
- ◆ Handspun Slate LAHS
- ◆ Sheer Mesh * A5
- ◆ Silver Mesh B9
- ◆ Steel Mesh * A9
- ◆ Canyon Zephyr * K9
- ◆ Desert Zephyr * K8
- ◆ Shadow Zephyr * K1
- ◆ Gray G2
- ◆ Grey Tigris * L6
- ◆ White G1
- ◆ Whitestone * K4

L2 LAMINATES CODES

Woodgrain

- ◆ Lowell Ash LLA1
- ◆ Natural Recon LNR1
- ◆ Phantom Ecru LPE1
- ◆ Portico Teak LPT1
- ◆ Skyline Walnut LSW1

(Door panels not available in L2)

WORKSURFACE EDGE BAND

- ◆ Black P
- ◆ Bourbon Cherry H
- ◆ Brownstone EY
- ◆ Charcoal S
- ◆ Cognac COGN
- ◆ Designer White DW
- ◆ Florence Walnut FW
- ◆ Fossil EH
- ◆ Greige R
- ◆ Harvest C
- ◆ Kingswood Walnut KI
- ◆ Light Gray Q
- ◆ Loft LOFT
- ◆ Lowell Ash DL
- ◆ Mahogany N
- ◆ Mocha MOCH
- ◆ Muslin T
- ◆ Natural Maple D
- ◆ Natural Recon NR
- ◆ Phantom Ecru PE
- ◆ Pinnacle PINC
- ◆ Platinum K
- ◆ Portico Teak DP
- ◆ Shadow * SHDW
- ◆ Shaker Cherry F
- ◆ Skyline Walnut SW
- ◆ Sterling Ash SA

WORKSURFACE GROMMET

- ◆ Black P
- ◆ Brownstone EY
- ◆ Charcoal S
- ◆ Fossil EH
- ◆ Greige T5
- ◆ Light Gray Q
- ◆ Loft LOFT
- ◆ Muslin T3
- ◆ Shadow * SHDW
- ◆ Titanium T1
- ◆ Designer White DW
- ◆ Champagne Metallic T4
- ◆ Platinum Metallic T1

FRAMES, TRIM, METAL TILES, CUSTOM BRACKET KIT, WORKSURFACE SUPPORTS, STEEL OVERHEAD STORAGE CHASSIS

PAINT CODES

P1

- ◆ Black P
- ◆ Brownstone P7D
- ◆ Charcoal S
- ◆ Designer White PJW
- ◆ Fossil P28
- ◆ Greige T5
- ◆ Light Gray Q
- ◆ Loft LOFT
- ◆ Muslin T3
- ◆ Putty L
- ◆ Shadow * SHDW
- ◆ Titanium P8T

P2

- ◆ Champagne Metallic T4
- ◆ Platinum Metallic T1
- ◆ Silver PR6

DUPLEX/PORTED TILE

PLASTIC CODES

- ◆ Black P
- ◆ Charcoal S
- ◆ Designer White DW
- ◆ Loft LOFT
- ◆ Muslin T3
- ◆ Titanium TI

Recommendations

| Paint | Duplex-Data Code |
|-----------------------|-------------------|
| Black P | Black P |
| Brownstone P7D | Brownstone EY |
| Charcoal S | Charcoal S |
| Designer White PJW | Designer White DW |
| Fossil P28 | Charcoal S |
| Greige T5 | Muslin T3 |
| Light Gray Q | Loft LOFT |
| Loft LOFT | Loft LOFT |
| Muslin T3 | Muslin T3 |
| Putty L | Black P |
| Shadow SHDW | Muslin T3 |
| Silver PR6 | Titanium T1 |
| Titanium P8T | Titanium T1 |
| Champagne Metallic T4 | Muslin T3 |
| Platinum Metallic T1 | Titanium T1 |

► LAMINATE TOPS

SPECIFY: Model Number,
Laminate
Edge Color
Grommet Color
EXAMPLE: HWR2424P.K&R.T5

► PAINTED PRODUCTS

SPECIFY: Model Number,
Paint Color
EXAMPLE: HRVSHV24.T1

◆◆◆ For lead time information see page 19.

* De-emphasized

Edge Treatments



"P" Edgeband
(Color must be selected.)

WORKING WITH ABODE™ COMPONENTS

Configurations

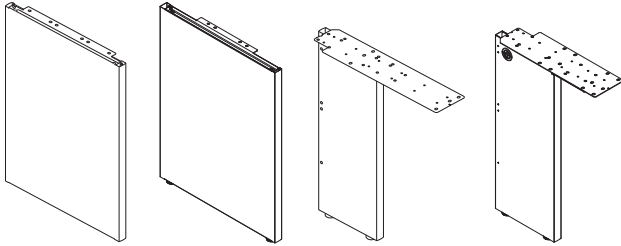

End Panels and Support Legs

Each are available in two options: freestanding or panel mount. The only difference between the two options are the panel-mount models come with a left- or right-handed bracket to attach the support to a panel in a systems application.

The 11"D end panel is used to support peninsulas.

Corner Desk Legs

Corner desk legs have a 90-degree bend and welded construction. The strong construction allows gussets or half-height modesty panels to be used with corner legs.

Bridge Kits

Bridge kits include: two flat brackets, two modesty panel-to-end panel attachment brackets, and two tie straps. This kit is used when attaching a bridge unit between two rectangular worksurfaces.

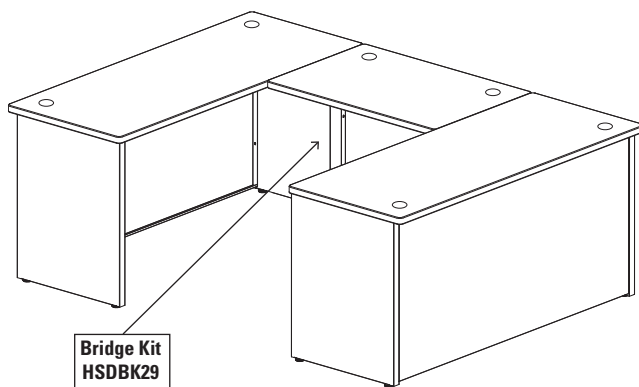

There are some bridge instances where only half of a bridge kit is needed (e.g., using a bridge between a rectangular worksurface and a corner or peninsula). A return kit may be ordered for these instances.

Support Column

Support columns are used to support one end of curvilinear worksurfaces. Includes column, worksurface bracket kit HWSA2, attaching hardware, and adjustable glides.

Return Kits

Return kits include: one flat bracket, one modesty panel-to-end panel attachment bracket, and one tie strap. These are used when attaching a return to a primary desk. Return kits can also be used in some bridge applications — one example is shown below when using a peninsula.

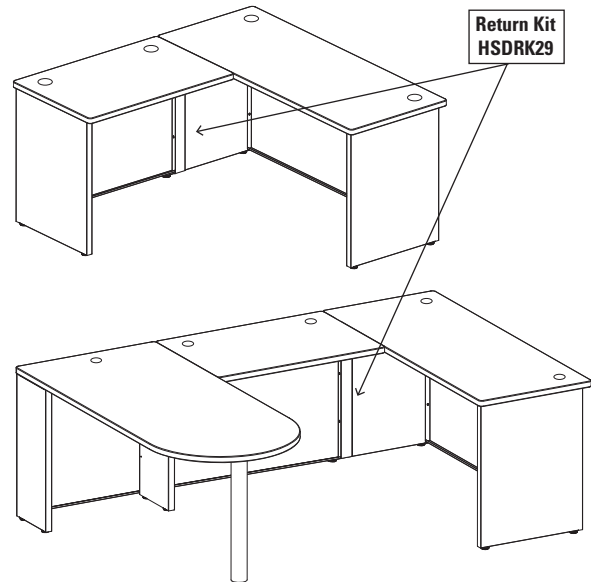

Desk-to-Panel Attachment Kits

Desk-to-panel attachment kits are used to connect a worksurface and modesty panel perpendicular to a panel of corresponding width. Opposing end of worksurface must be attached with an end panel, support leg, or corner leg mounted directly under this worksurface.

When using a corner or corner cove worksurface with the rear corner attached to a panel, and opposing end of worksurface is attached to a freestanding desk, use corner w/desk attachment kit. Hand of unit is determined from the user's side of the desk (right-hand unit attaches to right side of modesty).

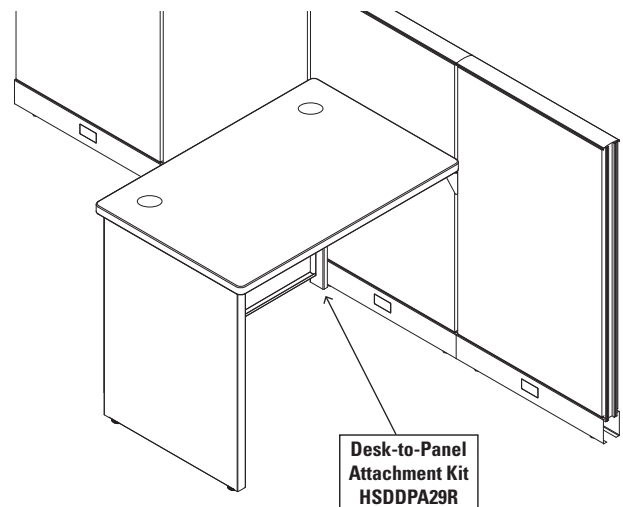

Corner w/Desk Panel Attachment Kit

Corner w/desk panel attachment kit connects the rear corner of a corner or corner cove worksurface and modesty panel to a panel when the opposing end of the worksurface shares a support leg with an adjacent freestanding desk and the support leg is mounted under the freestanding desk. Hand of unit is determined from the user's side of the desk (left-hand unit attaches to left side of modesty).

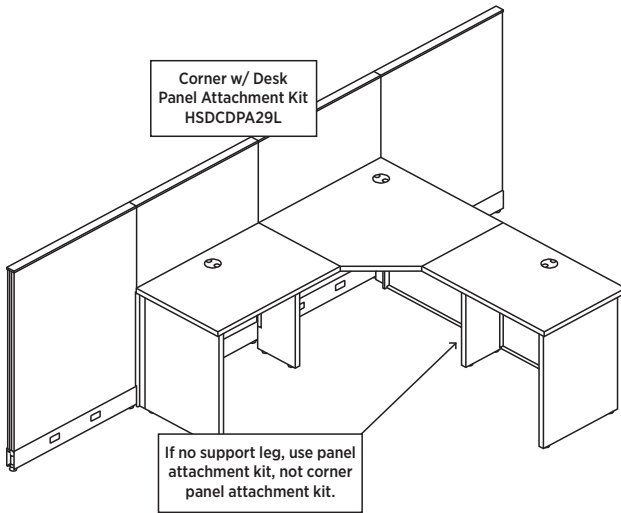

Corner Worksurfaces

Corner worksurfaces accommodate 90-degree corner desk legs.

In-Line Connections of Desks

Shared leg can be used at in-line connections to support adjacent rectangular desks.

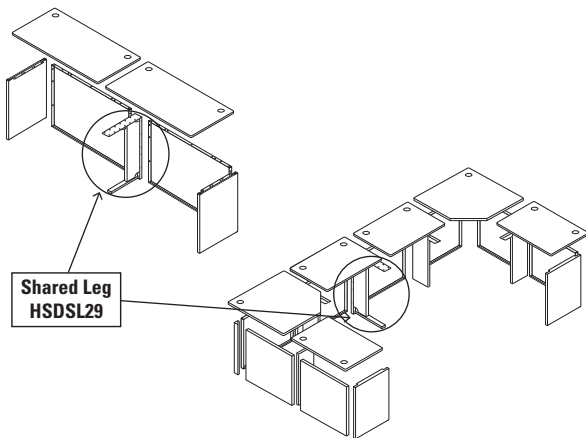

Pedestals and Storage

Pedestals must be ordered smaller than the depth of the worksurface. For example, 18" D peds should be used with 24" D worksurfaces. 18" D or 23" D pedestals can be used with 30" D worksurfaces. Using 18" D laterals or personal files provide additional storage options under 24" D worksurfaces.

Modesty Panels

The following are some general guidelines for Abode™ modesty panels:

- **Desk:** Modesty panel width is the same width as the worksurface
- **Return:** Modesty panel width is 6" greater than the width of the worksurface
- **Bridge connecting two rectangular worksurfaces:** Modesty panel width is 12" greater than the width of the bridge worksurface
- **Bridge connecting a rectangular worksurface and corner or peninsula:** Modesty panel width is 6" greater than the width of the worksurface
- **Corner connecting to an adjacent worksurface:** Modesty panel width is the same width as the worksurface.

Stand-Alone Corner Modesty Panels

Stand-alone corner modesty panels are used only when one or both sides of a corner or corner cove worksurface are freestanding and NOT attached to another worksurface. Specify the width the same as the width of the worksurface.

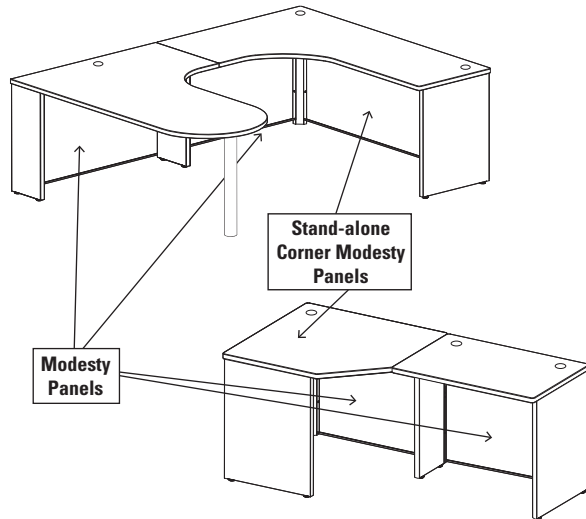

Gussets "G"

Gussets can be used in place of a modesty panel with desks 36" W to 60" W. Gussets can also be used with corner desk legs.

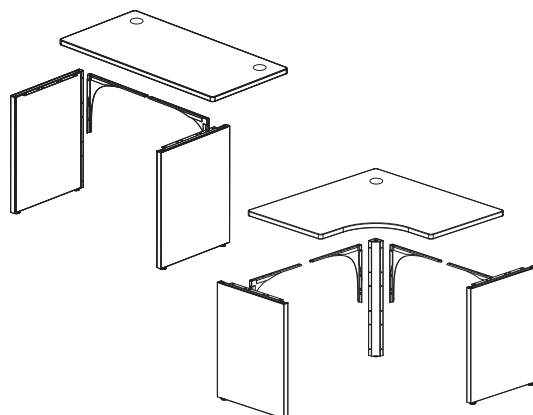



Icon Legend on page 19

The following five pages contain examples of Abode™ workstations. Each “typical” is shown in 3D hidden line perspective. Along with each typical is a complete listing of all the components. Use the information and format to better understand the layout and specifying of Abode™.

| QTY | DESCRIPTION | MODEL | LIST PRICE | PRICE EXTENSION |
|---------------|---|------------|----------------|-----------------|
| 1 | Rectangle Worksurface 24”D x 36”W | HWR2436P | \$382 | \$382 |
| 2 | Freestanding End Panel Support 24”D x 29½”H | HSDEP2429F | \$220 | \$440 |
| 1 | Full-Height Modesty Panel 36”W x 29½”H | HSDMP369 | \$207 | \$207 |
| TOTAL: | | | \$1,029 | |

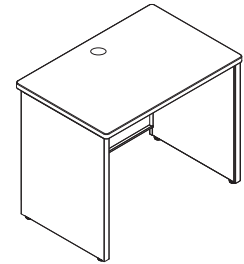

FREESTANDING DESK

| QTY | DESCRIPTION | MODEL | LIST PRICE | PRICE EXTENSION |
|---------------|---|------------|--------------|-----------------|
| 1 | Rectangle Worksurface 24”D x 36”W | HWR2436P | \$382 | \$382 |
| 1 | Freestanding End Panel Support 24”D x 29½”H | HSDEP2429F | \$220 | \$220 |
| 1 | Full-Height Modesty Panel 36”W x 29½”H | HSDMP369 | \$207 | \$207 |
| 1 | Desk-to-Panel Attachment Kit – Right-Handed 29½”H | HSDPA29R | \$112 | \$112 |
| TOTAL: | | | \$921 | |

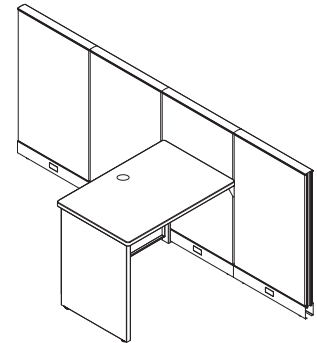

PANEL-ATTACHED DESK

| QTY | DESCRIPTION | MODEL | LIST PRICE | PRICE EXTENSION |
|---------------|---|------------|----------------|-----------------|
| 1 | Rectangle Worksurface 24”D x 36”W | HWR2436P | \$382 | \$382 |
| 1 | Rectangle Worksurface 24”D x 60”W | HWR2460P | \$526 | \$526 |
| 1 | Full-Height Modesty Panel 42”W x 29½”H | HSDMP429 | \$212 | \$212 |
| 3 | Freestanding End Panel Support 24”D x 29½”H | HSDEP2429F | \$220 | \$660 |
| 1 | Return Kit 29½”H | HSDRK29 | \$115 | \$115 |
| 1 | Full-Height Modesty Panel 60”W x 29½”H | HSDMP609 | \$225 | \$225 |
| TOTAL: | | | \$2,120 | |

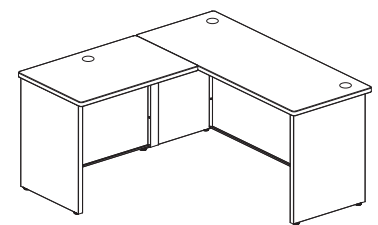

RETURN DESK

Attached to a primary or return desk

| QTY | DESCRIPTION | MODEL | LIST PRICE | PRICE EXTENSION |
|---------------|---|------------|----------------|-----------------|
| 1 | Rectangle Worksurface 24”D x 48”W | HWR2448P | \$446 | \$446 |
| 1 | Full-Height Modesty Panel 54”W x 29½”H | HSDMP549 | \$223 | \$223 |
| 1 | Freestanding End Panel Support 24”D x 29½”H | HSDEP2429F | \$220 | \$220 |
| 1 | Return Kit 29½”H | HSDRK29 | \$115 | \$115 |
| 1 | End Panel Support – Right 24”D x 29½”H | HRVEP2429R | \$246 | \$246 |
| 1 | End Panel Support – Left 24”D x 29½”H | HRVEP2429L | \$246 | \$246 |
| 1 | Rectangle Worksurface 24”D x 60”W | HWR2460P | \$526 | \$526 |
| TOTAL: | | | \$2,022 | |

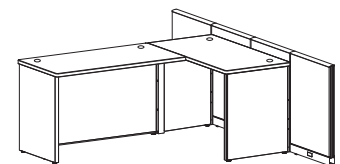

RETURN DESK

Attached to a panel-hung worksurface



| QTY | DESCRIPTION | MODEL | LIST PRICE | PRICE EXTENSION |
|---------------|---|------------|----------------|-----------------|
| 1 | Rectangle Worksurface 24"D x 42"W | HWR2442P | \$419 | \$419 |
| 2 | Rectangle Worksurface 24"D x 72"W | HWR2472P | \$583 | \$1,166 |
| 1 | Full-Height Modesty Panel 54"W x 29½"H | HSDMP549 | \$223 | \$223 |
| 1 | Bridge Kit | HSDBK29 | \$219 | \$219 |
| 2 | Full-Height Modesty Panel 72"W x 29½"H | HSDMP729 | \$234 | \$468 |
| 4 | Freestanding End Panel Support 24"D x 29½"H | HSDEP2429F | \$220 | \$880 |
| TOTAL: | | | \$3,375 | |

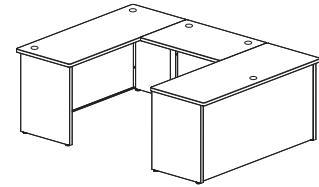

BRIDGE DESK

Attached between two primary desks

| QTY | DESCRIPTION | MODEL | LIST PRICE | PRICE EXTENSION |
|---------------|---|------------|----------------|-----------------|
| 1 | Rectangle Worksurface 24"D x 36"W | HWR2436P | \$382 | \$382 |
| 1 | Rectangle Worksurface 24"D x 60"W | HWR2460P | \$526 | \$526 |
| 1 | Peninsula Worksurface 30"D x 60"W | HWP3060P | \$693 | \$693 |
| 1 | Full-Height Modesty Panel 42"W x 29½"H | HSDMP429 | \$212 | \$212 |
| 1 | Full-Height Modesty Panel 30"W x 29½"H | HSDMP309 | \$205 | \$205 |
| 2 | Freestanding End Panel Support 24"D x 29½"H | HSDEP2429F | \$220 | \$440 |
| 1 | Full-Height Modesty Panel 60"W x 29½"H | HSDMP609 | \$225 | \$225 |
| 1 | Freestanding End Panel Support 11"D x 29½"H | HSDEP1129F | \$207 | \$207 |
| 1 | Freestanding Support Leg 24"D x 29½"H | HSDSL2429F | \$231 | \$231 |
| 1 | Support Column for Peninsula | HCNLEG29 | \$240 | \$240 |
| 1 | Return Kit 29½"H | HSDRK29 | \$115 | \$115 |
| TOTAL: | | | \$3,476 | |

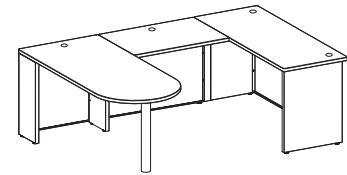

BRIDGE DESK AND PENINSULA

Attached to a primary desk

| QTY | DESCRIPTION | MODEL | LIST PRICE | PRICE EXTENSION |
|---------------|---|------------|----------------|-----------------|
| 1 | Corner Worksurface 24"D x 36"W | HWCS3624P | \$575 | \$575 |
| 2 | Stand-Alone Corner Modesty Panel 36"W x 29½"H | HSDCMP3629 | \$207 | \$414 |
| 2 | Freestanding End Panel Support 24"D x 29½"H | HSDEP2429F | \$220 | \$440 |
| 1 | Corner Desk Leg 29½"H | HSDDL29 | \$187 | \$187 |
| TOTAL: | | | \$1,616 | |

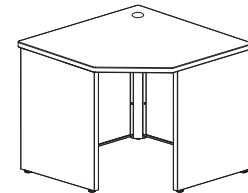

CORNER DESK

Stand-alone

| QTY | DESCRIPTION | MODEL | LIST PRICE | PRICE EXTENSION |
|---------------|---|------------|----------------|-----------------|
| 1 | Corner Worksurface 24"D x 36"W | HWCS3624P | \$575 | \$575 |
| 1 | Rectangle Worksurface 24"D x 36"W | HWR2436P | \$382 | \$382 |
| 1 | Stand-Alone Corner Modesty Panel 36"W x 29½"H | HSDCMP3629 | \$207 | \$207 |
| 2 | Full-Height Modesty Panel 36"W x 29½"H | HSDMP369 | \$207 | \$414 |
| 2 | Freestanding End Panel Support 24"D x 29½"H | HSDEP2429F | \$220 | \$440 |
| 1 | Freestanding Support Leg 24"D x 29½"H | HSDSL2429F | \$231 | \$231 |
| 1 | Corner Desk Leg 29½"H | HSDDL29 | \$187 | \$187 |
| TOTAL: | | | \$2,436 | |

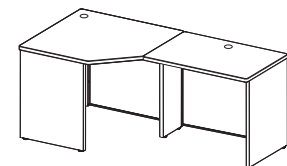

CORNER DESK

With adjacent desk attached at one side



Icon Legend on page 19

ABODE™ Typicals

WORKSTATIONS

| QTY | DESCRIPTION | MODEL | LIST PRICE | PRICE EXTENSION |
|---------------|---|------------|----------------|-----------------|
| 2 | Rectangle Worksurface 24"D x 36"W | HWR2436P | \$382 | \$764 |
| 1 | Rectangle Worksurface 24"D x 72"W | HWR2472P | \$583 | \$583 |
| 1 | Corner Worksurface 24"D x 36"W | HWCS3624P | \$575 | \$575 |
| 1 | Full-Height Modesty Panel 42"W x 29½"H | HSDMP429 | \$212 | \$212 |
| 1 | Return Kit 29½"H | HSDRK29 | \$115 | \$115 |
| 2 | Freestanding Support Leg 24"D x 29½"H | HSDSL2429F | \$231 | \$462 |
| 3 | Freestanding End Panel Support 24"D x 29½"H | HSDEP2429F | \$220 | \$660 |
| 1 | Full-Height Modesty Panel 72"W x 29½"H | HSDMP729 | \$234 | \$234 |
| 3 | Full-Height Modesty Panel 36"W x 29½"H | HSDMP369 | \$207 | \$621 |
| 1 | Corner Desk Leg 29½"H | HSDDL29 | \$187 | \$187 |
| TOTAL: | | | \$4,413 | |

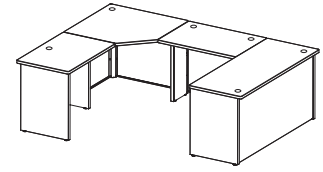

BRIDGE DESK

Attached between corner and primary desk

| QTY | DESCRIPTION | MODEL | LIST PRICE | PRICE EXTENSION |
|---------------|--|------------|----------------|-----------------|
| 1 | Jetty - Right-Handed 48"D x 72"W x 24" x 30" | HWJ59ABRP | \$929 | \$929 |
| 1 | Corner Cove - Right-Handed 72" x 48" x 24" x 24" | HWV95AARP | \$918 | \$918 |
| 2 | Full-Height Modesty Panel 48"W x 29½"H | HSDMP489 | \$220 | \$440 |
| 1 | Stand-Alone Corner Modesty Panel 72"W x 29½"H | HSDCMP7229 | \$234 | \$234 |
| 1 | Freestanding End Panel Support 11"D x 29½"H | HSDEP1129F | \$207 | \$207 |
| 1 | Freestanding Support Leg 24"D x 29½"H | HSDSL2429F | \$231 | \$231 |
| 1 | Freestanding End Panel Support 24"D x 29½"H | HSDEP2429F | \$220 | \$220 |
| 1 | Corner Desk Leg 29½"H | HSDDL29 | \$187 | \$187 |
| 1 | Support Column | HCNLEG29 | \$240 | \$240 |
| TOTAL: | | | \$3,606 | |

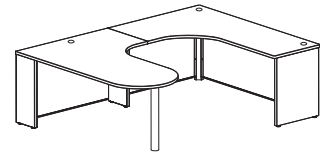

"U" WITH JETTY AND CORNER COVE

| QTY | DESCRIPTION | MODEL | LIST PRICE | PRICE EXTENSION |
|---------------|--|-----------------|-----------------|-----------------|
| 4 | Rectangular Worksurface 24"D x 72"W | HWR2472P | \$583 | \$2,332 |
| 2 | Abound® Panel Frame 35"H x 24"W | HRVF3524P | \$258 | \$516 |
| 2 | Abound® Panel Frame 35"H x 48"W | HRVF3548P | \$298 | \$596 |
| 4 | Abound® Fabric Tile 30"H x 24"W | HRVT3024T | \$110 | \$440 |
| 4 | Abound® Fabric Tile 30"H x 48"W | HRVT3048T | \$150 | \$600 |
| 2 | Abound® Frameless Glass 7½"H x 72"W | HRVT0772F | \$929 | \$1,858 |
| 2 | Abound® Finished End Trim 30"H | HRVC30PF | \$86 | \$172 |
| 2 | Abode™ Desk-to-Panel Attachment Kits - Left 29½"H | HSDDPA29L | \$112 | \$224 |
| 2 | Abode™ Desk-to-Panel Attachment Kits - Right 29½"H | HSDDPA29R | \$112 | \$224 |
| 4 | Abode™ Full-Height Modesty Panel 72"W | HSDMP729 | \$234 | \$936 |
| 4 | Abode™ Freestanding End Panel 24"D | HSDEP2429F | \$220 | \$880 |
| 2 | Contain® Low Credenza, Box/Lateral - Right 48"W | HSCP224818LBFOM | \$1,792 | \$3,584 |
| 2 | Contain® Low Credenza, Box/Lateral - Left 48"W | HSCP224818RBFOM | \$1,792 | \$3,584 |
| 4 | Flagship® Freestanding Support Ped B/B/F | H19717A | \$779 | \$3,116 |
| 4 | Voi® Above Privacy Screen 60"W x 13"H | HLSL1260 | \$508 | \$2,032 |
| 4 | Credenza Storage-to-Panel Bracket | HSCAPB | \$220 | \$880 |
| TOTAL: | | | \$21,974 | |

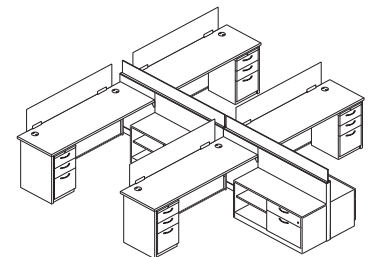

ABODE™ WITH ABOUND®

ABODE™ Typicals



Icon Legend on page 19

WORKSTATIONS

| QTY | DESCRIPTION | MODEL | LIST PRICE | PRICE EXTENSION |
|---------------|--|------------|------------|-----------------|
| 2 | Rectangular Worksurface 24"D x 36"W | HWR2436P | \$382 | \$764 |
| 1 | Corner Worksurface 24"D x 36"W | HWCS3624P | \$575 | \$575 |
| 2 | Abode™ Freestanding End Panel 24"D | HSDEP2429F | \$220 | \$440 |
| 2 | Abode™ Freestanding Support Leg 24"D | HSDSL2429F | \$231 | \$462 |
| 1 | Abode™ Corner Desk Leg 29½"H | HSDDL29 | \$187 | \$187 |
| 4 | Abode™ Full-Height Modesty Panel 36"W | HSDMP369 | \$207 | \$828 |
| 2 | Flagship® Freestanding Support Ped B/B/F | H19717A | \$779 | \$1,558 |
| TOTAL: | | | | \$4,814 |

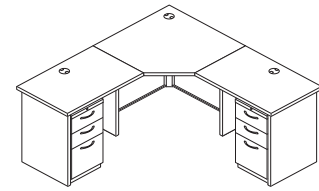

CORNER WITH RETURN

| QTY | DESCRIPTION | MODEL | LIST PRICE | PRICE EXTENSION |
|---------------|--|------------|------------|-----------------|
| 8 | Accelerate® Tackable Panel 65"H x 24"W | HETP6524FP | \$410 | \$3,280 |
| 2 | Accelerate® Tackable Panel 65"H x 48"W | HETP6548FP | \$526 | \$1,052 |
| 6 | Accelerate® Top Cap 24"W | HETC24 | \$42 | \$252 |
| 2 | Accelerate® Top Cap 72"W | HETC72 | \$114 | \$228 |
| 4 | Rectangular Worksurface 24"D x 72"W | HWR2472P | \$583 | \$2,332 |
| 4 | Rectangular Worksurface 24"D x 48"W | HWR2448P | \$446 | \$1,784 |
| 2 | Accelerate® "T" Connector 65"H | HEC65PTN | \$155 | \$310 |
| 1 | Accelerate® "X" Connector 65"H | HEC65PXN | \$149 | \$149 |
| 6 | Accelerate® Panel Finished End Covers 65"H | HEFEC65P | \$73 | \$438 |
| 8 | Accelerate® Worksurface Bracket Kit | HWSB2 | \$52 | \$416 |
| 4 | Flat Bracket 24"D | HHN831124 | \$72 | \$288 |
| 4 | Flagship® Freestanding Support Ped B/B/F | H19717A | \$779 | \$3,116 |
| 2 | Abode™ Desk-to-Panel Attachment Kits - Left 29½"H | HSDDPA29L | \$112 | \$224 |
| 2 | Abode™ Desk-to-Panel Attachment Kits - Right 29½"H | HSDDPA29R | \$112 | \$224 |
| 4 | Abode™ Freestanding End Panel 24"D | HSDEP2429F | \$220 | \$880 |
| 4 | Abode™ Full-Height Modesty Panel 72"W | HSDMP729 | \$234 | \$936 |
| 4 | Systems Overhead Storage Flipper Door 48"W | HRVOH48FM | \$697 | \$2,788 |
| 4 | Systems Overhead Storage Shelf 24"W | HRVSH24 | \$257 | \$1,028 |
| 4 | Vol® Above Privacy Screen 42"W x 13"H | HLSL1242 | \$387 | \$1,548 |
| 2 | "T" Connector | HECST | \$24 | \$48 |
| 1 | "X" Connector | HECSX | \$29 | \$29 |
| TOTAL: | | | | \$21,350 |

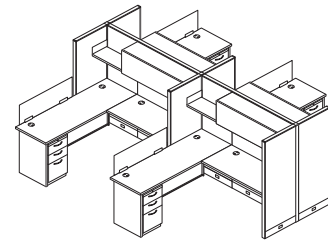

ABODE™ WITH ACCELERATE®

| QTY | DESCRIPTION | MODEL | LIST PRICE | PRICE EXTENSION |
|---------------|---|------------|------------|-----------------|
| 1 | Rectangular Worksurface 24"D x 72"W | HWR2472P | \$583 | \$583 |
| 1 | Rectangular Worksurface 24"D x 48"W | HWR2448P | \$446 | \$446 |
| 1 | Peninsula Worksurface 30"D x 72"W | HWP3072P | \$837 | \$837 |
| 1 | Stack-on Full Clearance w/o Doors 13"D x 72"W x 34¾"H | H386572N | \$1,034 | \$1,034 |
| 1 | Flipper Doors w/ Lock 36"W x 16"H | H387215 | \$643 | \$643 |
| 1 | Tackboard for 72"W Hutch 72" | HT72ND | \$577 | \$577 |
| 1 | Support Column for Peninsula 29"H | HCNLEG29 | \$240 | \$240 |
| 2 | Abode™ Freestanding End Panel 24"D | HSDEP2429F | \$220 | \$440 |
| 1 | Abode™ Freestanding End Panel 11"D | HSDEP1129F | \$207 | \$207 |
| 1 | Abode™ Freestanding Support Leg 24"D | HSDSL2429F | \$231 | \$231 |
| 1 | Abode™ Return Kit | HSDRK29 | \$115 | \$115 |
| 1 | Abode™ Full-Height Modesty Panel 72"W | HSDMP729 | \$234 | \$234 |
| 1 | Abode™ Full-Height Modesty Panel 54"W | HSDMP549 | \$223 | \$223 |
| 1 | Abode™ Full-Height Modesty Panel 30"W | HSDMP309 | \$205 | \$205 |
| 1 | Flagship® 2 Drawer "A" Pull Lateral 30"W | H9170A | \$1,116 | \$1,116 |
| TOTAL: | | | | \$7,131 |

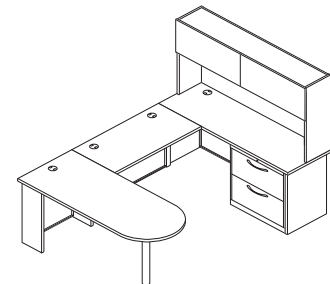

PENINSULA U



Icon Legend on page 19

ABODE™ Typicals

| QTY | DESCRIPTION | MODEL | LIST PRICE | PRICE EXTENSION |
|---------------|---|-------------|------------|-----------------|
| 2 | Rectangular Worksurface 24"D x 72"W | HWR2472P | \$583 | \$1,166 |
| 1 | Height Adjustable Worksurface 24"D x 48"W | HHATW2448CT | \$446 | \$446 |
| 1 | Stack-on Full Clearance w/o Doors 13"D x 72"W x 34¾"H | H386572N | \$1,034 | \$1,034 |
| 1 | Flipper Doors w/ Lock 36"W x 16"H | H387215 | \$643 | \$643 |
| 1 | Tackboard for 72"W Hutch 72" | HT72ND | \$577 | \$577 |
| 2 | Abode™ Full-Height Modesty Panel 72"W | HSDMP729 | \$234 | \$468 |
| 4 | Abode™ Freestanding End Panel 24"D | HSDEP2429F | \$220 | \$880 |
| 1 | Systems Height Adjustable Base 24"D | HHAB352L | \$1,210 | \$1,210 |
| 2 | Flagship® 2 Drawer "A" Pull Lateral 30"W | H9170A | \$1,116 | \$2,232 |
| TOTAL: | | | | \$8,656 |

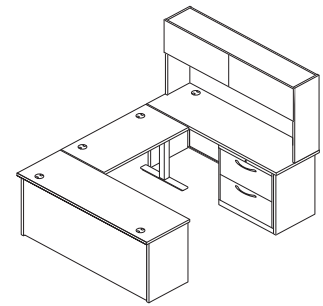

WORKSTATION U

WORKSTATIONS

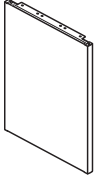

| DESCRIPTION | MODEL | SHIP WEIGHT | CUBE | LIST PRICE BY PAINT GRADE | |
|--|-------------------|-------------|------|---------------------------|--------------|
| | | | | P1 | P2 |
| Freestanding End Panel Supports | | | | | |
| 11"D | HSDEP1129F | 15 | 1.1 | \$207 | \$234 |
| 24"D | HSDEP2429F | 25 | 1.1 | \$220 | \$247 |
| 30"D | HSDEP3029F | 30 | 1.1 | \$244 | \$271 |

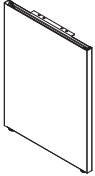

| | | | | | |
|---|-------------------|----|-----|--------------|--------------|
| Panel Mounted Full End Panel Supports* | | | | | |
| 29½"H x 11"D — Right — Panel Mount | HRVEP1129R | 16 | 1.4 | \$228 | \$257 |
| 29½"H x 11"D — Left — Panel Mount | HRVEP1129L | 16 | 1.4 | \$228 | \$257 |
| 29½"H x 24"D — Right — Panel Mount | HRVEP2429R | 21 | 1.4 | \$246 | \$275 |
| 29½"H x 24"D — Left — Panel Mount | HRVEP2429L | 21 | 1.4 | \$246 | \$275 |
| 29½"H x 30"D — Right — Panel Mount | HRVEP3029R | 23 | 1.4 | \$268 | \$297 |
| 29½"H x 30"D — Left — Panel Mount | HRVEP3029L | 23 | 1.4 | \$268 | \$297 |

*Must be connected into panel slots. When an installation of worksurfaces is 8 feet or greater, a full end panel or universal support leg must be used at 90 degree panel junctions or in a shared position to support adjoining worksurfaces.

Specify paint

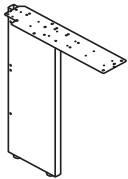

| | | | | | |
|---------------------------------|-------------------|----|-----|--------------|--------------|
| Freestanding Support Leg | | | | | |
| 24"D | HSDSL2429F | 25 | 1.1 | \$231 | \$258 |
| 30"D | HSDSL3029F | 25 | 1.1 | \$259 | \$286 |

NOTES: To be used when connecting a non-rectangular worksurface to a rectangular worksurface.

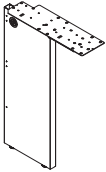

| | | | | | |
|-----------------------------------|-----------------|----|-----|--------------|--------------|
| Panel Mounted Support Leg* | | | | | |
| 29½"H to support 24"D | HRVCLG24 | 16 | 1.4 | \$218 | \$247 |
| 29½"H to support 30"D | HRVCLG30 | 17 | 1.4 | \$238 | \$267 |

*Must be connected into panel slots. When an installation of worksurfaces is 8 feet or greater, a full end panel or universal support leg must be used at 90 degree panel junctions or in a shared position to support adjoining worksurfaces.

Non-handed unit
Specify paint





NOTES:

All Abode™ Components are compatible with Abound® and Accelerate® panel systems and Systems Worksurfaces.

HOW TO SPECIFY

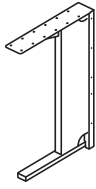
| | |
|--|--|
| <p>Select Model Number</p> <p>HSDEP1129F . T1</p> | <p>Select Paint Color</p> <p>See page 410</p> |
|--|--|

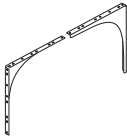

| | DESCRIPTION | MODEL | SHIP WEIGHT | CUBE | LIST PRICE BY PAINT GRADE | |
|---|--|--|-------------|------------|----------------------------|--------------------------|
| | | | | | P1 | P2 |
|  | Abode™ Shared Leg NOTES: To be used when joining two rectangular surfaces. Can be used as a stand-alone support in panel systems. 1/2" radius opening for cord management. | HDSL29 | 18 | 1.5 | \$420 | \$447 |
|  | Corner Desk Leg 29 1/2" H NOTES: Corner desk legs have 90° bend and welded construction. | HDDL29 | 7 | 0.4 | \$187 | \$214 |
|  | Gussets (1 pair) NOTES: Gussets may be used instead of a modesty panel to create freestanding desks 36" W to 60" W. | HSDG | 7 | 0.5 | \$129 | \$146 |
|  | Flat Bracket 24" D 30" D ! Charcoal only. | HHN831124 ☺ HHN831130 | 3 3 | 0.3 0.4 | \$72 \$72 | N/A N/A |

NOTES:

! All Abode™ Components are compatible with Abound® and Accelerate® panel systems and Systems Worksurfaces.

| EXTERNAL CHANNEL SELECTION GUIDE | | | | | | |
|----------------------------------|-----------------------|--|------------|------------|------------|------------|
| Support Combination | | Worksurface Width for Rectangle, Wedge, and Saddle | | | | |
| Support 1 | Support 2 | 84 in | 72 in | 66 in | 60 in | 54 in |
| O-Leg | O-Leg | NA | HLSLZ5SC72 | HLSLZ5SC66 | HLSLZ5SC60 | HLSLZ5SC54 |
| O-Leg | Slim Profile Pedestal | HLSLZ5SC84 | HLSLZ5SC66 | HLSLZ5SC60 | HLSLZ5SC54 | NA |
| O-Leg | Bookcase | HLSLZ5SC72 | HLSLZ5SC66 | HLSLZ5SC60 | HLSLZ5SC54 | NA |
| O-Leg | Pedestal | HLSLZ5SC72 | HLSLZ5SC60 | HLSLZ5SC54 | NA | NA |
| O-Leg | End-Panel | HLSLZ5SC84 | HLSLZ5SC60 | HLSLZ5SC54 | NA | NA |
| Slim Profile Pedestal | Slim Profile Pedestal | HLSLZ5SC72 | HLSLZ5SC60 | HLSLZ5SC54 | NA | NA |
| Slim Profile Pedestal | Bookcase | HLSLZ5SC72 | HLSLZ5SC60 | HLSLZ5SC54 | NA | NA |
| Slim Profile Pedestal | Pedestal | HLSLZ5SC66 | HLSLZ5SC54 | NA | NA | NA |
| Slim Profile Pedestal | End-Panel | HLSLZ5SC66 | HLSLZ5SC54 | NA | NA | NA |
| Pedestal | Bookcase | HLSLZ5SC66 | HLSLZ5SC54 | NA | NA | NA |
| End-Panel | Bookcase | HLSLZ5SC66 | HLSLZ5SC54 | NA | NA | NA |
| Bookcase | Bookcase | HLSLZ5SC66 | HLSLZ5SC54 | NA | NA | NA |
| End-Panel | End-Panel | HLSLZ5SC60 | NA | NA | NA | NA |
| Pedestal | Pedestal | HLSLZ5SC60 | NA | NA | NA | NA |
| Pedestal | End-Panel | HLSLZ5SC60 | NA | NA | NA | NA |
| O-Leg | Lateral/Multifile | HLSLZ5SC54 | NA | NA | NA | NA |
| Bookcase | Lateral/Multifile | NA | NA | NA | NA | NA |
| Slim Profile Pedestal | Lateral/Multifile | NA | NA | NA | NA | NA |
| Pedestal | Lateral/Multifile | NA | NA | NA | NA | NA |
| End-Panel | Lateral/Multifile | NA | NA | NA | NA | NA |

*All Rudder worksurfaces use external channel model HLSLZ5SC60.

HOW TO SPECIFY

| | |
|--|---|
| <p>Select Model Number</p> <p>H S D S L 2 9</p> | <p>Select Paint Color</p> <p>See page 410</p> <p>T 1</p> |
|--|---|

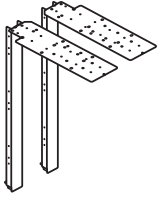

DESCRIPTION

MODEL

SHIP WEIGHT

CUBE

LIST PRICE BY PAINT GRADE

P1

P2

Bridge Kit

29½”H

HSDBK29

10

0.4

\$219

\$246

NOTES: Add 12” to your modesty width when using a Bridge Kit. Bridge Kits include two flat brackets, two modesty panel-to-end panel attachment brackets, and two tie straps.

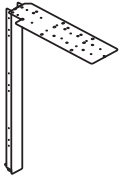

Return Kit

29½”H

HSDRK29

6

0.4

\$115

\$142

NOTES: Add 6” to your modesty width when using a Return Kit. Return Kits include one flat bracket, one modesty panel-to-end panel attachment bracket, and one tie strap.



Desk-to-Panel Attachment Kit

29½”H

HSDDPA29L

5

0.3

\$112

\$122

29½”H

HSDDPA29R

5

0.3

\$112

\$122



Corner with Desk-to-Panel Attachment Kit

29½”H

HSDCPA29L

5

0.3

\$112

\$122

29½”H

HSDCPA29R

5

0.3

\$112

\$122

NOTES: This Attachment Kit utilizes the same modesty panel specification rules as the Freestanding Corner Leg.

HOW TO SPECIFY

Select Model Number

Select Paint Color

See page 410

H S D B K 2 9 .

T 1

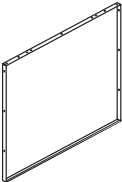
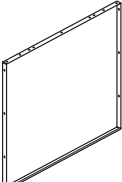
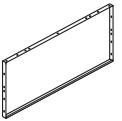
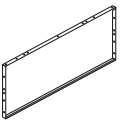

| | DESCRIPTION | MODEL | SHIP WEIGHT | CUBE | LIST PRICE BY PAINT GRADE | |
|---|---|-------------------|-------------|------|---------------------------|-------|
| | | | | | P1 | P2 |
|  | Full-Height Modesty Panel | | | | | |
| | 29½" H x 24" W | HSDMP249 | 5.0 Ⓢ | 0.6 | \$199 | \$216 |
| | 29½" H x 30" W | HSDMP309 | 7.0 Ⓢ | 0.6 | \$205 | \$222 |
| | 29½" H x 36" W | HSDMP369 | 8.0 | 0.8 | \$207 | \$224 |
| | 29½" H x 42" W | HSDMP429 | 9.0 | 0.9 | \$212 | \$229 |
| | 29½" H x 48" W | HSDMP489 | 11.0 | 1.0 | \$220 | \$237 |
| | 29½" H x 54" W | HSDMP549 | 12.0 | 2.2 | \$223 | \$240 |
| | 29½" H x 60" W | HSDMP609 | 13.0 | 2.2 | \$225 | \$242 |
| | 29½" H x 66" W | HSDMP669 | 15.0 | 2.6 | \$231 | \$248 |
| | 29½" H x 72" W | HSDMP729 | 16.0 | 3.0 | \$234 | \$251 |
| ! To be used in all applications except when connecting a Corner Leg to an End Panel or a Corner Leg to a Shared Leg. | | | | | | |
|  | Full-Height Stand-Alone Corner Modesty Panel | | | | | |
| | 29½" H x 36" W | HSDCMP3629 | 7.0 | 1.9 | \$207 | \$224 |
| | 29½" H x 42" W | HSDCMP4229 | 9.0 | 1.9 | \$212 | \$229 |
| | 29½" H x 48" W | HSDCMP4829 | 10.0 | 2.3 | \$220 | \$237 |
| | 29½" H x 60" W | HSDCMP6029 | 14.0 | 4.7 | \$225 | \$242 |
| | 29½" H x 72" W | HSDCMP7229 | 16.0 | 5.4 | \$234 | \$251 |
| NOTES: To be used when connecting a Corner Leg to an End Panel or Shared Leg. | | | | | | |
|  | Half-Height Modesty Panel | | | | | |
| | 14" H x 24" W | HSDMP244 | 5.1 Ⓢ | 0.4 | \$186 | \$203 |
| | 14" H x 30" W | HSDMP304 | 6.6 Ⓢ | 0.4 | \$190 | \$207 |
| | 14" H x 36" W | HSDMP364 | 8.1 Ⓢ | 0.5 | \$193 | \$210 |
| | 14" H x 42" W | HSDMP424 | 9.6 Ⓢ | 0.6 | \$204 | \$221 |
| | 14" H x 48" W | HSDMP484 | 11.0 Ⓢ | 0.6 | \$207 | \$224 |
| | 14" H x 54" W | HSDMP544 | 13.0 Ⓢ | 0.8 | \$210 | \$227 |
| | 14" H x 60" W | HSDMP604 | 14.0 Ⓢ | 0.8 | \$214 | \$231 |
| | 14" H x 66" W | HSDMP664 | 16.0 Ⓢ | 1.0 | \$220 | \$237 |
| | 14" H x 72" W | HSDMP724 | 17.0 Ⓢ | 1.0 | \$223 | \$240 |
|  | Half-Height Stand-Alone Corner Modesty Panel | | | | | |
| | 14" H x 36" W | HSDCMP3614 | 4.0 Ⓢ | 0.5 | \$193 | \$210 |
| | 14" H x 42" W | HSDCMP4214 | 4.0 Ⓢ | 0.6 | \$204 | \$221 |
| | 14" H x 48" W | HSDCMP4814 | 5.0 Ⓢ | 0.6 | \$207 | \$224 |
| | 14" H x 60" W | HSDCMP6014 | 6.0 Ⓢ | 0.8 | \$214 | \$231 |
| | 14" H x 72" W | HSDCMP7214 | 7.0 Ⓢ | 1.0 | \$223 | \$240 |

NOTES:

- Desk: Modesty panel width is the same width as the worksurface.
- Return: Modesty panel width is 6" greater than the width of the return worksurface.
- Bridge connecting two rectangular worksurfaces: Modesty panel width is 12" greater than the width of the bridge worksurface.
- Bridge connecting a rectangular worksurface and corner or peninsula: Modesty panel width is 6" greater than the width of the worksurface.
- Corner connecting to an adjacent worksurface: Modesty panel width is the same width as the worksurface.

HOW TO SPECIFY

| | |
|----------------------------|---------------------------|
| Select Model Number | Select Paint Color |
| HSDMP249 | See page 410 |
| T1 | |

ABOUND®

Want to see more? Scan here
to check out hon.com.



WORKSTATIONS



Abound® shown with Contain® Storage, Ignition® Seating, and Voi® Desking.

ABOUND®

Why settle for a one-dimensional, uninspired cubicle when you can choose a workstation with dynamic flexibility, powerful performance, and stunning architectural aesthetics? Abound raises the bar on cohesive solutions that keep us connected, engaged, and productive. With numerous tile styles to choose from — fabric, glass, gallery panels, and more. You can customize Abound to suit any space, from collaborative meeting spaces to private offices and everything in between.

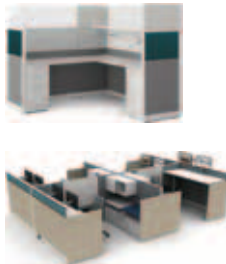

FEATURES

- With multiple tile options, materials and fabrics, Abound supports a variety of work styles and office budgets.
- Top channel lay-in or beltline capabilities expand your cabling capacity.
- Open Base frame option brings a lighter scale aesthetic and allows for easier cleaning.
- Straight lines, crisp edges and rectilinear worksurfaces fit precisely together to create a tailored, architectural presence.
- With a variety of layout options and compatibility with HON storage, height adjustable bases and freestanding desks, the options with Abound are endless.

ABOUT® ORDERING INFORMATION

GALLERY PANELS, WORKSURFACES, COUNTERTOPS, CORNER SHELVES W/EDGE BAND, HARD-SURFACE TILE OVERHEAD STORAGE DOORS*

L1 LAMINATES CODES

Woodgrain

| | |
|--------------------------|------|
| ◆ Bourbon Cherry | H |
| ◆ Cognac | COGN |
| ◆ Florence Walnut | LFW1 |
| ◆ Harvest | C |
| ◆ Kingswood Walnut | LK1I |
| ◆ Mahogany | N |
| ◆ Mocha | MOCH |
| ◆ Natural Maple | D |
| ◆ Pinnacle | PINC |
| ◆ Shaker Cherry | F |
| ◆ Sterling Ash | LSA1 |

Solid

| | |
|------------------------|------|
| ◆ Black | P |
| ◆ Charcoal | S |
| ◆ Designer White | LDW1 |
| ◆ Loft | LOFT |

Patterned

| | |
|---------------------------|------|
| ◆ Handspun Chestnut | LAHC |
| ◆ Handspun Dove | LAHD |
| ◆ Handspun Pearl | LAHP |
| ◆ Handspun Slate | LAHS |
| ◆ Sheer Mesh * | A5 |
| ◆ Silver Mesh | B9 |
| ◆ Steel Mesh * | A9 |
| ◆ Canyon Zephyr * | K9 |
| ◆ Desert Zephyr * | K8 |
| ◆ Shadow Zephyr * | K1 |
| ◆ Gray | G2 |
| ◆ Grey Tigris * | L6 |
| ◆ White | G1 |
| ◆ Whitestone * | K4 |

► LAMINATE TOPS

SPECIFY: Model Number.
Laminate
Edge Color
Grommet Color
EXAMPLE: HWR2424P.K8.R.T5

► PAINTED PRODUCTS

SPECIFY: Model Number.
Paint Color
EXAMPLE: HRVSHV24.T1

► PANEL FRAMES

SPECIFY: Model Number.
Paint
EXAMPLE: HRVF3524P.T3

Suffix "A"



Satin Chrome
Arch Pull

* Laminate Front Overheads only available in L1 Woodgrain Laminates.

◆◆◆ For lead time information see page 19.

* De-emphasized

GALLERY PANELS, WORKSURFACES, COUNTERTOPS, CORNER SHELVES W/EDGE BAND, HARD-SURFACE TILE OVERHEAD STORAGE DOORS* *continued*

L2 LAMINATES CODES

Woodgrain

| | |
|------------------------|------|
| ◆ Lowell Ash | LLA1 |
| ◆ Natural Recon | LNR1 |
| ◆ Phantom Ecru | LPE1 |
| ◆ Portico Teak | LPT1 |
| ◆ Skyline Walnut | LSW1 |

(Door panels not available in L2)

WORKSURFACE EDGE BAND

| | |
|--------------------------|------|
| ◆ Black | P |
| ◆ Bourbon Cherry | H |
| ◆ Brownstone | EY |
| ◆ Charcoal | S |
| ◆ Cognac | COGN |
| ◆ Designer White | DW |
| ◆ Florence Walnut | FW |
| ◆ Fossil | EH |
| ◆ Greige | R |
| ◆ Harvest | C |
| ◆ Kingswood Walnut | KI |
| ◆ Light Gray | Q |
| ◆ Loft | LOFT |
| ◆ Lowell Ash | DL |
| ◆ Mahogany | N |
| ◆ Mocha | MOCH |
| ◆ Muslin | T |
| ◆ Natural Maple | D |
| ◆ Natural Recon | NR |
| ◆ Phantom Ecru | PE |
| ◆ Pinnacle | PINC |
| ◆ Platinum | K |
| ◆ Portico Teak | DP |
| ◆ Shadow * | SHDW |
| ◆ Shaker Cherry | F |
| ◆ Skyline Walnut | SW |
| ◆ Sterling Ash | SA |

Edge Treatments



"P" Edgeband

(Color must be selected.)

► HOW TO ORDER

- 1) Select desired model numbers.
- 2) Order worksurfaces to correspond to width of panel behind them.
- 3) Add appropriate prefix and suffix if Tee-Span worksurfaces are needed.

WORKSURFACE GROMMET

PLASTIC CODES

| | |
|----------------------------|------|
| ◆ Black | P |
| ◆ Brownstone | EY |
| ◆ Charcoal | S |
| ◆ Fossil | EH |
| ◆ Greige | T5 |
| ◆ Light Gray | Q |
| ◆ Loft | LOFT |
| ◆ Muslin | T3 |
| ◆ Titanium | T1 |
| ◆ Shadow * | SHDW |
| ◆ Designer White | DW |
| ◆ Champagne Metallic | T4 |
| ◆ Platinum Metallic | T1 |

FRAMES, TRIM, METAL TILES, CUSTOM BRACKET KIT, WORKSURFACE SUPPORTS, STEEL OVERHEAD STORAGE CHASSIS

PAINT CODES

| | |
|----------------------------|------|
| P1 | |
| ◆ Black | P |
| ◆ Brownstone | P7D |
| ◆ Charcoal | S |
| ◆ Designer White | PJW |
| ◆ Fossil | P28 |
| ◆ Greige | T5 |
| ◆ Light Gray | Q |
| ◆ Loft | LOFT |
| ◆ Muslin | T3 |
| ◆ Putty | L |
| ◆ Shadow * | SHDW |
| ◆ Titanium | P8T |
| P2 | |
| ◆ Champagne Metallic | T4 |
| ◆ Platinum Metallic | T1 |
| ◆ Silver | PR6 |
| ◆ Solar Black | P8X |

DUPLEX/PORTED TILE

PLASTIC CODES

| | |
|------------------------|------|
| ◆ Black | P |
| ◆ Charcoal | S |
| ◆ Designer White | DW |
| ◆ Loft | LOFT |
| ◆ Muslin | T3 |
| ◆ Titanium | T1 |

Recommendations

| Paint | Duplex-Data Code |
|-----------------------------|-------------------|
| Black P | Black P |
| Brownstone P7D | Brownstone EY |
| Charcoal S | Charcoal S |
| Designer White PJW | Designer White DW |
| Fossil P28 | Charcoal S |
| Greige T5 | Muslin T3 |
| Light Gray Q | Loft LOFT |
| Loft LOFT | Loft LOFT |
| Muslin T3 | Muslin T3 |
| Putty L | Black P |
| Shadow SHDW | Muslin T3 |
| Silver PR6 | Titanium T1 |
| Titanium P8T | Titanium T1 |
| Champagne Metallic T4 | Muslin T3 |
| Platinum Metallic T1 | Titanium T1 |

ABOUND[®] FABRIC PATTERNS & CODES

PRICE CODE AA

| FACTOR | FACT |
|-----------|--------|
| ◆ Bark | FACT20 |
| ◆ Barley | FACT15 |
| ◆ Cascade | FACT25 |
| ◆ Feather | FACT30 |

PRICE CODE A

| APPOINT | APN |
|---------------|-------|
| ◆ Artichoke | APN11 |
| ◆ Blackberry | APN32 |
| ◆ Bronze | APN22 |
| ◆ Carbon | APN28 |
| ◆ Chai | APN12 |
| ◆ Cherry | APN30 |
| ◆ Dark Pewter | APN17 |
| ◆ Dune | APN15 |
| ◆ Espresso | APN23 |
| ◆ Framboise | APN31 |
| ◆ Frost | APN34 |
| ◆ Jet | APN27 |
| ◆ Lawn | APN25 |
| ◆ Mandarin | APN29 |
| ◆ Morel | APN09 |
| ◆ Nimbus | APN16 |
| ◆ Platinum | APN24 |
| ◆ Turquoise | APN26 |

CENTURION CU

Not available on heights over 54"H

| | |
|-------------|------|
| ◆ Apricot | CU47 |
| ◆ Bark | CU25 |
| ◆ Black | CU10 |
| ◆ Espresso | CU49 |
| ◆ Fog | CU03 |
| ◆ Frost | CU22 |
| ◆ Goldenrod | CU27 |
| ◆ Indigo | CU06 |
| ◆ Iris | CU50 |
| ◆ Iron Ore | CU19 |
| ◆ Jade | CU83 |
| ◆ Marsala | CU63 |
| ◆ Morel | CU24 |
| ◆ Navy | CU98 |
| ◆ Peacock | CU97 |
| ◆ Pear | CU84 |
| ◆ Ruby | CU67 |
| ◆ Sapphire | CU09 |

PRICE CODE A *continued*

| ETCH* | ECH |
|-------------|-------|
| ◆ Axis | ECH13 |
| ◆ Blend | ECH14 |
| ◆ Cast | ECH12 |
| ◆ Highlight | ECH10 |
| ◆ Midtone | ECH11 |
| ◆ Outline | ECH08 |
| ◆ Shade | ECH09 |
| ◆ Tonal | ECH16 |
| ◆ Vanish | ECH15 |

EXCHANGE* EXG

| | |
|-------------|--------|
| ◆ Iron | EXG916 |
| ◆ Nickel | EXG914 |
| ◆ Pistachio | EXG910 |
| ◆ Root | EXG913 |
| ◆ Rupee | EXG903 |
| ◆ Shadow | EXG911 |
| ◆ Silver | EXG915 |
| ◆ Sisal | EXG917 |
| ◆ Stone | EXG912 |

LANDSCAPE* LN

| | |
|------------|------|
| ◆ Azure | LN55 |
| ◆ Cornsilk | LN15 |
| ◆ Drift | LN05 |
| ◆ Khaki | LN20 |
| ◆ Sheen | LN10 |
| ◆ Slate | LN35 |
| ◆ Umber | LN25 |
| ◆ Urban | LN30 |

LUCY* LC

| | |
|------------|------|
| ◆ Aspen | LC32 |
| ◆ Cornsilk | LC30 |
| ◆ Dusk | LC22 |
| ◆ Fawn | LC33 |
| ◆ Graphite | LC34 |
| ◆ Mist | LC20 |
| ◆ Neutra | LC24 |
| ◆ Pewter | LC35 |
| ◆ Snowdrop | LC28 |

PRICE CODE A *continued*

| REFLECTIONS* | REF |
|--------------|-------|
| ◆ Galvanized | REF29 |
| ◆ Ice | REF20 |
| ◆ Loggia | REF21 |
| ◆ Mistral | REF28 |
| ◆ Moonstone | REF23 |
| ◆ Pewter | REF22 |
| ◆ Stainless | REF24 |
| ◆ Vanilla | REF25 |
| ◆ Winter | REF27 |

REFUGE* RFG

| | |
|------------|-------|
| ◆ Artesian | RFG96 |
| ◆ Dune | RFG92 |
| ◆ Eclipse | RFG90 |
| ◆ Frost | RFG93 |
| ◆ Glacier | RFG91 |
| ◆ Mineral | RFG98 |
| ◆ Tidal | RFG94 |

SARTO* SRT

| | |
|--------------|-------|
| ◆ Ash | SRT88 |
| ◆ Fog | SRT14 |
| ◆ Lemongrass | SRT49 |
| ◆ Mist | SRT45 |
| ◆ Mushroom | SRT76 |
| ◆ Oyster | SRT18 |
| ◆ Reef | SRT64 |
| ◆ Sesame | SRT93 |
| ◆ Shale | SRT52 |

TEMPEST* TP

| | |
|---------------|------|
| ◆ Dragonfly | TP30 |
| ◆ Frost | TP15 |
| ◆ Full Stream | TP80 |
| ◆ Gold Rush | TP10 |
| ◆ Slate | TP45 |
| ◆ Tumbleweed | TP70 |
| ◆ Wind Chill | TP40 |
| ◆ Zebra | TP35 |

NOTES: Analog, Disperse, and Exchange panel fabrics will be applied pattern cut. Disperse will not be available on 72"W panels.

◆◆◆ For lead time information see page 19.

* Directional fabrics

ABOUND[®] FABRIC PATTERNS & CODES

PRICE CODE B

| ANALOG* | ANLG |
|-------------|--------|
| ◆ Album | ANLG06 |
| ◆ Cartridge | ANLG04 |
| ◆ Cassette | ANLG09 |
| ◆ Dial | ANLG02 |
| ◆ Media | ANLG08 |
| ◆ Reel | ANLG07 |
| ◆ Signal | ANLG03 |
| ◆ Stereo | ANLG01 |
| ◆ Track | ANLG05 |

| COAST* | COA |
|-------------|-------|
| ◆ Channel | COA14 |
| ◆ Dune | COA03 |
| ◆ Headlands | COA10 |
| ◆ Marsh | COA02 |
| ◆ Pebble | COA12 |
| ◆ Pier | COA13 |
| ◆ Shoal | COA01 |
| ◆ Silt | COA06 |
| ◆ Tide | COA08 |

| DISPERSE* | DISP |
|----------------|--------|
| ◆ Autumn | DISP03 |
| ◆ Branch | DISP10 |
| ◆ Coffee Bean | DISP13 |
| ◆ Dusk | DISP09 |
| ◆ Emerald City | DISP08 |
| ◆ Gold Rush | DISP02 |
| ◆ Igloo | DISP11 |
| ◆ Ink | DISP06 |
| ◆ Mist | DISP12 |
| ◆ Oatmeal | DISP15 |
| ◆ Prince | DISP07 |
| ◆ Reservoir | DISP01 |
| ◆ Rose | DISP04 |
| ◆ Spring | DISP05 |
| ◆ Steel | DISP16 |
| ◆ Taupe | DISP14 |

PRICE CODE B *continued*

| MICA* | MCA |
|--------------|--------|
| ◆ Anthracite | MCA11 |
| ◆ Breeze | MCA18 |
| ◆ Bronze | MCA13 |
| ◆ Buff | MCA14 |
| ◆ Cremini | MCA17 |
| ◆ Crystal | MCAWIT |
| ◆ Dew | MCA20 |
| ◆ Dove | MCA12 |
| ◆ Fresh | MCA16 |
| ◆ Mineral | MCA15 |
| ◆ Nectar | MCA19 |
| ◆ Shale | MCA10 |

| SPIN* | SPIN |
|---------------|--------|
| ◆ Alabaster | SPIN02 |
| ◆ Cavern | SPIN03 |
| ◆ Cobblestone | SPIN04 |
| ◆ Ember | SPIN06 |
| ◆ Flame | SPIN07 |
| ◆ Heron | SPIN13 |
| ◆ Oat | SPIN01 |
| ◆ Ocean | SPIN12 |
| ◆ Plum | SPIN15 |
| ◆ Pool | SPIN11 |
| ◆ Raven | SPIN10 |
| ◆ Rhubarb | SPIN14 |
| ◆ Tropic | SPIN08 |
| ◆ Willow | SPIN05 |

PRICE CODE B *continued*

| TERRAIN* | TRRN |
|-----------|--------|
| ◆ Bay | TRRN05 |
| ◆ Bayou | TRRN35 |
| ◆ Canyon | TRRN30 |
| ◆ Cliff | TRRN45 |
| ◆ Crest | TRRN25 |
| ◆ Delta | TRRN10 |
| ◆ Plateau | TRRN15 |
| ◆ Ridge | TRRN20 |
| ◆ Valley | TRRN40 |

NOTES: Disperse panel fabric is applied pattern cut and is not available on 72"W Accelerate[®] panels or on 66"W tackboards, Voi[®] screens, and Empower[®].

Analog and Exchange panel fabric is applied pattern cut and is not available on 78"W tackboards, Voi[®] screens, and Empower[®].

◆◆◆ For lead time information see page 19.

* Directional fabrics

ABOUND[®] Typicals



Icon Legend on page 19

WORKSTATIONS

| QTY | DESCRIPTION | MODEL | LIST PRICE | PRICE EXTENSION |
|---------------|---|-----------|-----------------|-----------------|
| 1 | Flagship Series Pedestal "R" Pull Freestanding B/B/F | H19723R | \$837 | \$837 |
| 1 | Flagship 30"W 2-Drw "R" Pull Lateral 30"W x 28"H x 18"D | H9170R | \$1,116 | \$1,116 |
| 2 | Electrical Power Harness 3-1 & 2-2 Systems 36"W | HH871236 | \$227 | \$454 |
| 1 | Circuit 1 | HH873501 | \$47 | \$47 |
| 1 | Circuit 4 | HH873504 | \$47 | \$47 |
| 1 | Base In-Feed Cable Base 3-1 & 2-2 Systems | HH879072 | \$253 | \$253 |
| 2 | Abound Finished End Painted 65" | HRVC65PF | \$110 | \$220 |
| 3 | Abound L Connector Painted 65" | HRVC65PL | \$180 | \$540 |
| 6 | Abound Panel Frame 65"H x 36"W | HRVF6536P | \$318 | \$1,908 |
| 6 | Abound Top Cap Trim 36"W | HRVTC36 | \$65 | \$390 |
| 1 | Cantilever One Pair 24"D | HCTL242 | \$93 | \$93 |
| 24 | Abound Segment Bar 36"W | HRVFSB36 | \$25 | \$600 |
| 1 | Abound Overhead Metal Flipper Door 36" | HRVOH36FM | \$635 | \$635 |
| 24 | Abound Fabric Tile 15"H x 36"W | HRVT1536T | \$81 | \$1,944 |
| 12 | Abound Fabric Tile 30"H x 36"W | HRVT3036T | \$111 | \$1,332 |
| 1 | Systems Rectangular Worksurface Edgeband 24"D x 36"W | HWR2436P | \$382 | \$382 |
| 1 | Systems Left Corner Cove Worksurface Edgeband 72" x 36" x 24" x 24" | HWV93AALP | \$736 | \$736 |
| TOTAL: | | | \$11,534 | |

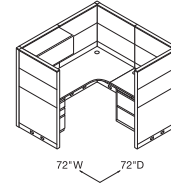

L-SHAPE WORKSTATION
72" W x 72" D

| QTY | DESCRIPTION | MODEL | LIST PRICE | PRICE EXTENSION |
|---------------|--|-------------|-----------------|-----------------|
| 1 | Electrical Power Harness 3-1 & 2-2 Systems 48"W | HH871248 | \$239 | \$239 |
| 1 | Circuit 1 | HH873501 | \$47 | \$47 |
| 1 | Circuit 4 | HH873504 | \$47 | \$47 |
| 1 | Base In-Feed Cable Base 3-1 & 2-2 Systems | HH879072 | \$253 | \$253 |
| 1 | Overhead Cabinet w/Sliding Door 48"W x 14 1/4"D x 14"H | HLSL1448S | \$1,208 | \$1,208 |
| 1 | Mobile Ped 20" x 15 1/8" x 21 1/2" | HLSL2016MP2 | \$893 | \$893 |
| 1 | Ped Cushion (Fabric Grade 2) 20" x 15 1/8" x 1" | HLSL2016PH2 | \$371 | \$371 |
| 1 | Stack-on Storage Panel Mounted Bracket | HLSLPMB | \$145 | \$145 |
| 2 | Rectangle Worksurface 24"D x 48" W | HLSLR2448 | \$337 | \$674 |
| 1 | Personal Storage Tower (RH) 24"D x 24"W x 65"H | HLSLW446RP | \$2,920 | \$2,920 |
| 1 | Abound Variable Height Finished End Painted 15" | HRVC15PFV | \$72 | \$72 |
| 1 | Abound Finished End Painted 50" | HRVC50PF | \$104 | \$104 |
| 1 | Abound L Connector Painted 50" | HRVC50PL | \$169 | \$169 |
| 1 | Abound Finished End Painted 65" | HRVC65PF | \$110 | \$110 |
| 2 | Abound L Connector Painted 65" | HRVC65PL | \$180 | \$360 |
| 1 | Abound Panel Frame 50"H x 24"W | HRVF5024P | \$284 | \$284 |
| 1 | Abound Panel Frame 50"H x 48"W | HRVF5048P | \$324 | \$324 |
| 3 | Abound Panel Frame 65"H x 24"W | HRVF6524P | \$307 | \$921 |
| 1 | Abound Panel Frame 65"H x 48"W | HRVF6548P | \$351 | \$351 |
| 4 | Abound Top Cap Trim 24"W | HRVTC24 | \$40 | \$160 |
| 2 | Abound Top Cap Trim 48"W | HRVTC48 | \$75 | \$150 |
| 1 | Flat Bracket 24"D | HHN831124 | \$72 | \$72 |
| 2 | Abound Segment Bar 24"W | HRVFSB24 | \$24 | \$48 |
| 2 | Abound Segment Bar 48"W | HRVFSB48 | \$27 | \$54 |
| 1 | Abound 15" High Clear Glass Tile 15"H x 24"W | HRVT1524G | \$515 | \$515 |
| 1 | Abound 15" High Clear Glass Tile 15"H x 48"W | HRVT1548G | \$661 | \$661 |
| 2 | Abound Fabric Tile 30"H x 24"W | HRVT3024T | \$99 | \$198 |
| 2 | Abound Fabric Tile 30"H x 48"W | HRVT3048T | \$134 | \$268 |
| 6 | Abound Fabric Tile 60"H x 24"W | HRVT6024T | \$147 | \$882 |
| 2 | Abound Fabric Tile 60"H x 48"W | HRVT6048T | \$237 | \$474 |
| 1 | Bracket to Attach Towers to Worksurfaces | HSTB2W1 | \$88 | \$88 |
| 2 | Worksurface Bracket Kit | HWSB2 | \$52 | \$104 |
| TOTAL: | | | \$13,166 | |

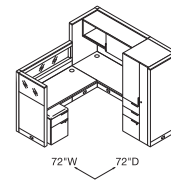

L-SHAPE WORKSTATION WITH STORAGE TOWER
72" W x 72" D



Icon Legend on page 19

ABOUND® Typicals

WORKSTATIONS

| QTY | DESCRIPTION | MODEL | LIST PRICE | PRICE EXTENSION |
|---------------|--|-----------|-----------------|-----------------|
| 2 | Electrical Pass-Thru Cable 3-1 & 2-2 Systems 60"W | HH871160 | \$151 | \$302 |
| 1 | Electrical Power Harness 3-1 & 2-2 Systems 24"W | HH871224 | \$227 | \$227 |
| 1 | Circuit 1 | HH873501 | \$47 | \$47 |
| 1 | Circuit 2 | HH873502 | \$47 | \$47 |
| 1 | Circuit 3 | HH873503 | \$47 | \$47 |
| 1 | Circuit 4 | HH873504 | \$47 | \$47 |
| 1 | Base In-Feed Cable Base 3-1 & 2-2 Systems | HH879072 | \$253 | \$253 |
| 6 | Abound Finished End Painted 50" | HRVC50PF | \$104 | \$624 |
| 2 | Abound T Connector Painted 50" | HRVC50PT | \$169 | \$338 |
| 1 | Abound X Connector Painted 50" | HRVC50PX | \$164 | \$164 |
| 6 | Abound Panel Frame 50"H x 24"W | HRVF5024P | \$284 | \$1,704 |
| 2 | Abound Panel Frame 50"H x 60"W | HRVF5060P | \$356 | \$712 |
| 6 | Abound Top Cap Trim 24"W | HRVTC24 | \$40 | \$240 |
| 2 | Abound Top Cap Trim 60"W | HRVTC60 | \$92 | \$184 |
| 8 | Worksurface Bracket Kit | HWSB2 | \$52 | \$416 |
| 12 | Abound Segment Bar 24"W | HRVFSB24 | \$24 | \$288 |
| 4 | Abound Segment Bar 60"W | HRVFSB60 | \$28 | \$112 |
| 4 | Abound Open Shelf 60" | HRVSH60 | \$394 | \$1,576 |
| 12 | Abound Fabric Tile 15"H x 24"W | HRVT1524T | \$73 | \$876 |
| 4 | Abound Fabric Tile 15"H x 60"W | HRVT1560T | \$104 | \$416 |
| 12 | Abound Fabric Tile 30"H x 24"W | HRVT3024T | \$99 | \$1,188 |
| 4 | Abound Fabric Tile 30"H x 60"W | HRVT3060T | \$151 | \$604 |
| 4 | Systems Rectangular Worksurface Edgeband 24"D x 60"W | HWR2460P | \$526 | \$2,104 |
| TOTAL: | | | \$12,516 | |

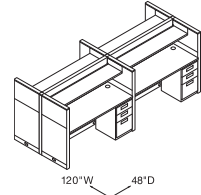

TOUCH-DOWN STATION
120"W x 48"D

| QTY | DESCRIPTION | MODEL | LIST PRICE | PRICE EXTENSION |
|---------------|---|-----------------|-----------------|-----------------|
| 2 | External Stiffener 72"W | HLSLZ5SC72 | \$119 | \$238 |
| 2 | Abound Panel Frame 35"H x 30"W | HRFF3530P | \$265 | \$530 |
| 4 | Abound Fabric Tile 30"H x 30"W | HRVT3030T | \$103 | \$412 |
| 4 | Abound Panel Frame 35"H x 36"W | HRFF3536P | \$271 | \$1,084 |
| 8 | Abound Fabric Tile 30"H x 36"W | HRVT3036T | \$111 | \$888 |
| 2 | Abound Panel Frame 35"H x 42"W | HRFF3542P | \$281 | \$562 |
| 4 | Abound Fabric Tile 30"H x 42"W | HRVT3042T | \$126 | \$504 |
| 2 | Abound Finished End Painted 35" | HRVC35PF | \$86 | \$172 |
| 2 | Abound L Connector Painted 35" | HRVC35PL | \$151 | \$302 |
| 4 | Frameless Frosted Glass 15"H x 72"W | HRVT1572F | \$1,041 | \$4,164 |
| 2 | Contain® 35 LB Credenza Counterweight Kit | HSCACW35 | \$221 | \$442 |
| 2 | Contain® Credenza Cushion (Fabric Grade 2) 36"W x 18"D | HSCAUC1836 | \$351 | \$702 |
| 2 | Worksurface O-Leg 6½"H x 30"W | HSCAWS6530 | \$254 | \$508 |
| 1 | Contain® Footed Metal Credenza with Laminate Front, Left 22" x 72" x 18" | HSCF227218RBFOL | \$2,564 | \$2,564 |
| 1 | Contain® Footed Metal Credenza with Laminate Front, Right 22" x 72" x 18" | HSCF227218LBFOL | \$2,564 | \$2,564 |
| 2 | Systems Rectangular Worksurface Edgeband 30"D x 72"W | HWR3072P | \$653 | \$1,306 |
| 2 | Worksurface Bracket Kit | HWSB2 | \$52 | \$104 |
| TOTAL: | | | \$17,046 | |

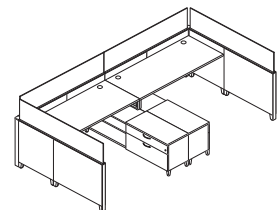

U-SHAPE TEAMING STATION
144"W x 72"D

ABOUND® Open Base Typicals



Icon Legend on page 19

WORKSTATIONS

| QTY | DESCRIPTION | MODEL | LIST PRICE | PRICE EXTENSION |
|-----|--|-------------|---------------|-----------------|
| 1 | Abound Panel Frame 50"H x 24"W | HRFF5024P | \$284 | \$284 |
| 2 | Abound Fabric Tile 30"H x 24"W | HRVT3024T | \$99 | \$198 |
| 1 | Abound 15" High Clear Glass Tile 12"H x 24"W | HRVT1524G | \$515 | \$515 |
| 2 | Abound 24"W Segment Bar | HRVFSB24 | \$24 | \$48 |
| 1 | Abound Panel Frame 50"H x 48"W | HRFF5048P | \$324 | \$324 |
| 2 | Abound Fabric Tile 30"H x 48"W | HRVT3048T | \$134 | \$268 |
| 1 | Abound 15" High Clear Glass Tile 15"H x 48"W | HRVT1548G | \$661 | \$661 |
| 2 | Abound 48"W Segment Bar | HRVFSB48 | \$27 | \$54 |
| 3 | Abound Panel Frame 65"H x 24"W | HRFF6524P | \$307 | \$921 |
| 6 | Abound Fabric Tile 60"H x 24"W | HRVT6024T | \$147 | \$882 |
| 1 | Abound Panel Frame 65"H x 48"W | HRFF6548P | \$351 | \$351 |
| 2 | Abound Fabric Tile 60"H x 48"W | HRVT6048T | \$237 | \$474 |
| 1 | Overhead Cabinet with Sliding Door 48"W x 14¼"D x 14"H | HLSL1448S | \$1,208 | \$1,208 |
| 1 | Mobile Ped 20" x 15½" x 21½" | HLSL2016MP2 | \$893 | \$893 |
| 1 | Ped Cushion 20" x 15½" x 1" | HLSL2016PH2 | \$371 | \$371 |
| 1 | Stack-on Storage Panel Mounted Bracket | HLSLPMB | \$145 | \$145 |
| 1 | Personal Storage Tower (RH) 24"D x 24"W x 65"H | HLSLW446RP | \$2,920 | \$2,920 |
| 1 | Abound Variable Height Finished End Painted 15" | HRVC15PFV | \$72 | \$72 |
| 1 | Abound Finished End Painted 50" | HRVC50PF | \$104 | \$104 |
| 1 | Abound L Connector Painted 50" | HRVC50PL | \$169 | \$169 |
| 1 | Abound Finished End Painted 65" | HRVC65PF | \$110 | \$110 |
| 2 | Abound L Connector Painted 65" | HRVC65PL | \$180 | \$360 |
| 1 | Bracket to Attach Towers to Worksurfaces | HSTB2W1 | \$88 | \$88 |
| 2 | Systems Rectangular Worksurface Edgeband 24"D x 48"W | HWR2448P | \$446 | \$892 |
| 2 | Worksurface Bracket Kit | HWSB2 | \$52 | \$104 |
| 1 | Abound Top Cap Trim 24"W | HRVTC24 | \$40 | \$40 |
| 1 | Abound Top Cap Trim 48"W | HRVTC48 | \$75 | \$75 |
| 1 | Abound Top Cap Trim 72"W | HRVTC72 | \$113 | \$113 |
| 1 | Flat Bracket 24"D | HHN831124 | \$72 | \$72 |
| | | | TOTAL: | \$12,716 |

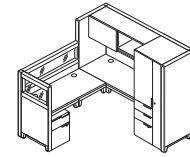

**L-SHAPE WORKSTATION
WITH STORAGE TOWER**

72"W x 72"D

ABOUT® FRAMES OVERVIEW

PANEL FRAME

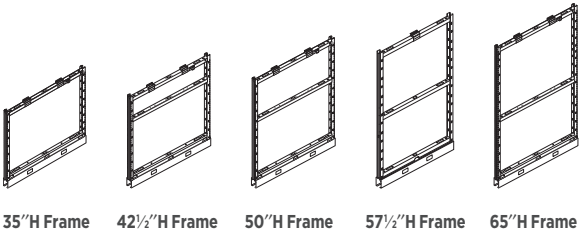

35" H Frame 42½" H Frame 50" H Frame 57½" H Frame 65" H Frame

OPEN BASE PANEL FRAME

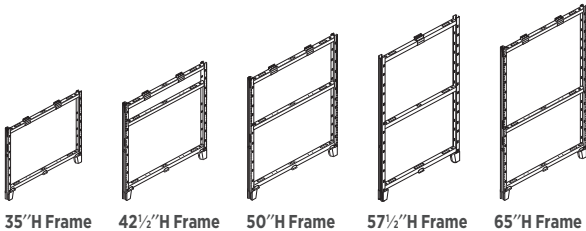

35" H Frame 42½" H Frame 50" H Frame 57½" H Frame 65" H Frame

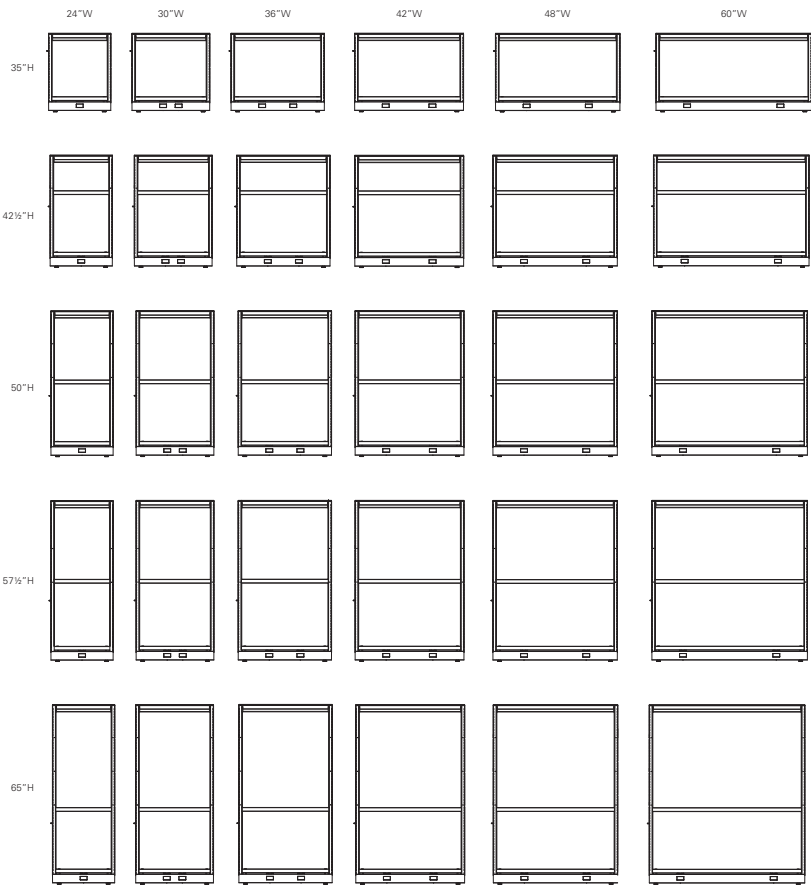

STACKING FRAMES

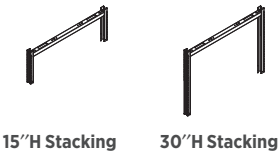

15" H Stacking 30" H Stacking

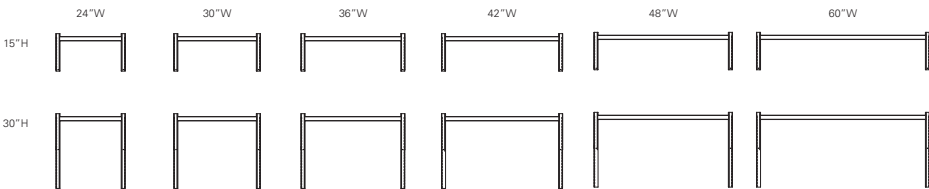

Reminder: Panel frame top caps must be ordered separately. Please refer to page 445. Do not specify top caps when putting frameless glass on top of the panel frame or when using a countertop work surface.

ABOUND® FRAMES OVERVIEW

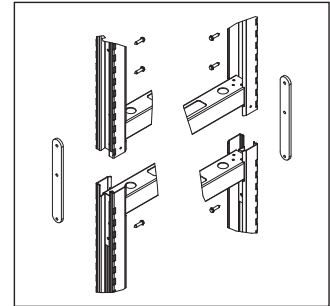
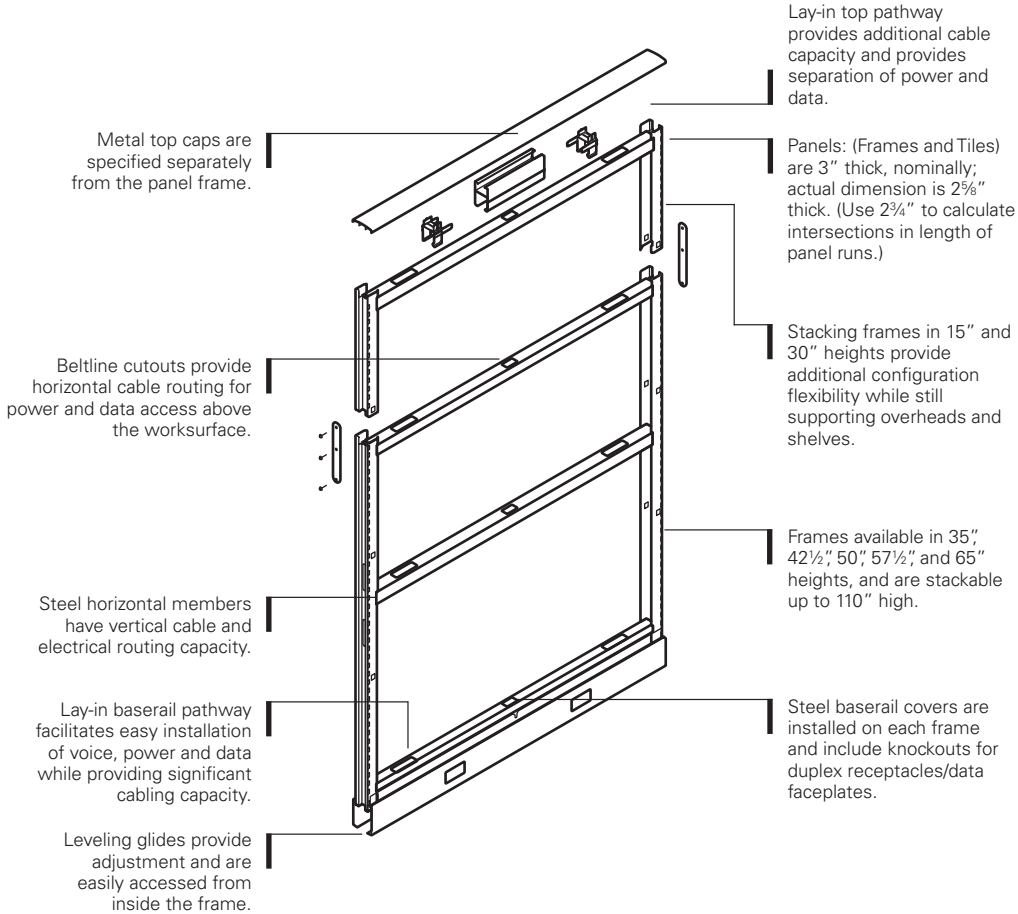

Stacking connection provides a solid metal-to-metal connection, allowing the stacking frame to accept hang-on components, per configuration guidelines.

Construction and Features

Specifications—formed, steel vertical members, with tubular steel horizontal members are welded into a sturdy, structural panel frame. Panel frames are shipped with base pathway covers installed.

Tiles, Panel Top Caps, and Segment Bars are ordered separately.

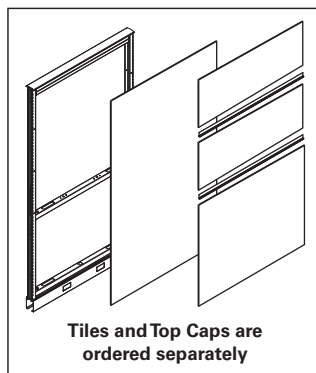

Additional design and specification information available at hon.com.

ABOUND[®] FRAMES OVERVIEW

FRAME DIMENSIONS (ACTUAL)

Depth: 2⁵/₈" (use 2³/₄" to calculate intersections in length of panel run)

Widths: 24", 30", 36", 42", 48", 60"

Heights*: Painted trim: 34¹/₂", 42", 49¹/₂", 57"H, 64¹/₂"

Stacking Frames: 15"H, 30"H

*with levelers fully retracted

Stacking frames can be added to the top of any 35"H, 50"H or 65"H frame. Adding stacking frames to 42¹/₂"H and 57¹/₂"H frames is not recommended due to inconsistencies in segmentation. 15"H and 30"H stacking frames can be used to add up to 45" of additional height to a standard frame. Do not combine differing frame widths in a single stack.

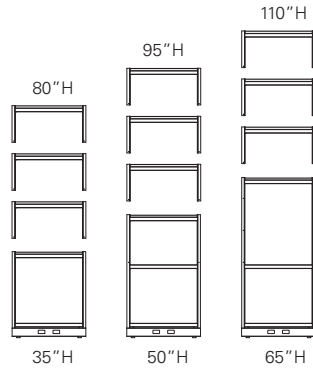

NOTE: When stacking on 42¹/₂"H or 57¹/₂"H frames, panel slots will be off by ¹/₂" compared to any other height panel. When stacking on 42¹/₂"H and 57¹/₂"H frames, hanging accessories will be ¹/₂" off in height compared to accessories hanging on panels at any height other than 42¹/₂"H and 57¹/₂"H.

BUILDING HORIZONTALLY WITH ABOUND FRAMES

Important planning guidelines: For adequate stability, one of two methods of stabilization must be adhered to:

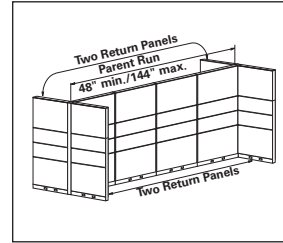

Method 1—Opposing returns:

A parent run must be a minimum of 48" and a maximum of 144" between return panels. The parent run must have a minimum of two return panels running in opposing directions on each end of run.

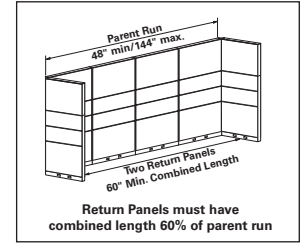

Method 2—Single-sided

| Spine Length: | 90 degree connector | 120 degree connector |
|---------------|---------------------|----------------------|
| 48"-108" | 72" total | 84" total |
| 110"-132" | 84" total | 96" total |
| 134"-144" | 96" total | 108" total |

ABOUND® FRAMES OVERVIEW

INTERSECTING CONNECTIONS

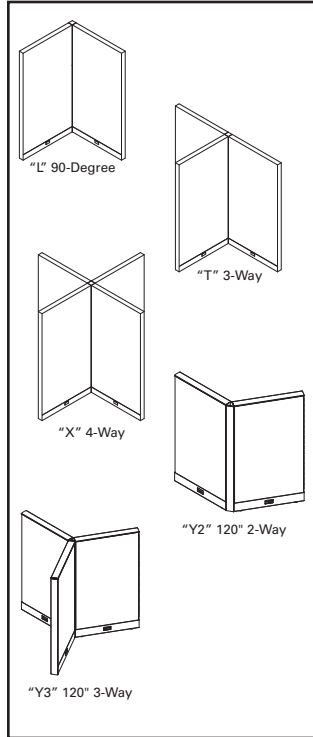

“L”, “T”, “X”, “Y2” and “Y3” connector kits are used when connecting frames at intersecting runs. For “L”, “T” and “X” connector kits, add $2\frac{3}{4}$ ” to the total length of the panel run for each intersection, whether located in the middle or at the end of the run.

Wall starter kits provide a means to affix a panel run to a permanent building wall. Kit adds $1\frac{1}{2}$ ” to length of panel run.

Segment bars — horizontal cross members required between tile segments. Must be specified on each side of frame. One Segment Bar is needed for each reveal between tiles.

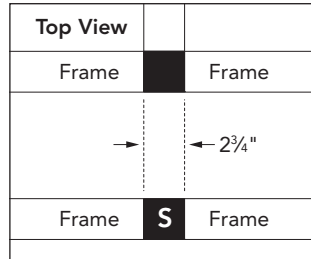
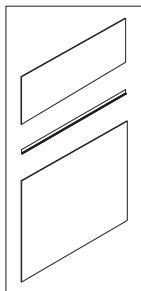

Extended straight connector kit “S” can be used to keep continuous runs dimensionally consistent with opposing panel runs which incorporate “T” or “X” intersections. (Add $2\frac{3}{4}$ ” to the length of the run for every extended straight connector used.)

IN-LINE CONNECTIONS

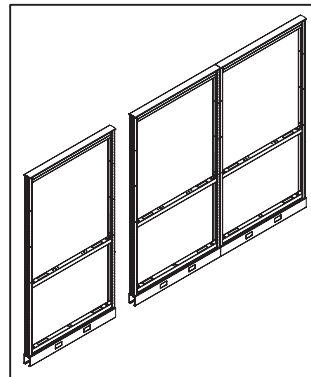

Direct connections between same height frames in a continuous run are accomplished with provided hardware. There is no incremental increase in dimension along the run.

END OF RUN

Finished end trim must be specified for the unconnected sides of panel frames. The Abound end trim adds $\frac{3}{8}$ ” to the length of the panel run. When adding a stacking frame, order finished end trim in the height that matches the stacking frame height. Move the end cap from the standard frame end trim to the stacking frame end trim.

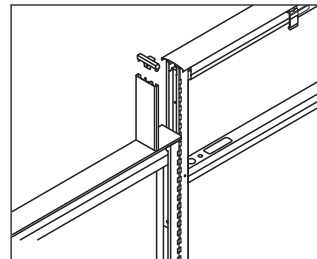

IN-LINE VARIABLE HEIGHT TRIM
In-line connections between different height panels require trim to cover the exposed frame of the taller panel. The bottom of the trim is contoured to match the profile of the frame top cap.

Multiple-height connections are accomplished by combining standard height panel connectors (35”H, 42½”H, 50”H, 57½”H, and 65”H) with shorter connectors (7”H, 15”H, 22”H, and 30”H). Start from the bottom-up — select the standard connector that corresponds to the height and connection type of the tallest panel, then use the shorter connectors for variable height and connector top cap trim. (See examples.)

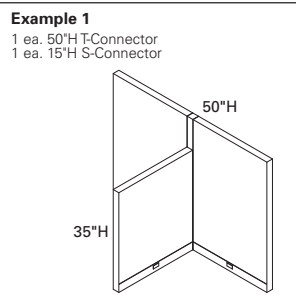

In variable height “T” connections — as shown above — you would use the connectors as indicated.

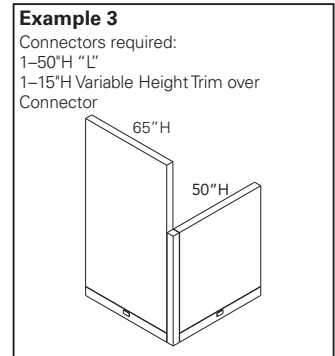
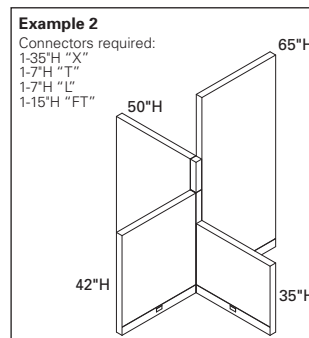

Example above represents Abound variable height “L” for 65” to 50” connection over connector.

VARIABLE HEIGHT CONNECTION TRIM

L, X and T connections between different height panels require trim to cover the exposed frame of the taller panel. The bottom of the trim is flat to match the profile of the Universal Connector top cap. Models are designated as “Variable Height Finished End over Connector Trim”. For variable height connections in a Y configuration, contact the HON Product Solutions group.

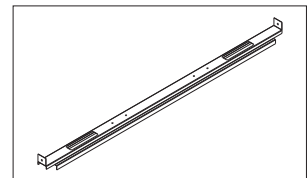

OPTIONAL STIFFENER SUPPORT

Stiffener supports can be used to provide additional rigidity to a panel when fabric tiles are on both sides of the frame. May also be used for routing power/data at non-standard heights.

ABOUT® CONNECTOR OVERVIEW

CONNECTOR KITS — ABOUT

- “L” 90° Connector Kit
- “T” 3-way Connector Kit
- “X” 4-way Connector Kit
- “S” “S” Extended Straight Connector Kit
- “Y2” 2-way 120° Connector Kit
- “Y3” 3-way 120° Connector Kit
- “W” Wall Starter Kit
- “F” End Trim Kit
- “V” Variable Height Finished End
- “FT” Variable Height Finished End over Connector

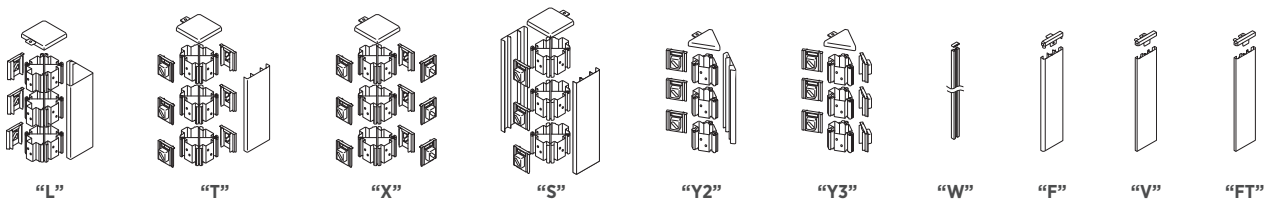

- About Connector Kits include universal connector block(s), bracket clips and painted metal trim.
- The universal connector block can be used for an L, T, X, or Extended Straight connections, simplifying staging and installation at the project site as well as future reconfigurations.
- Bracket clips are attached to the connector blocks as needed based upon connection type.
- While the connectors themselves are universal, About connector kits must be specified by connection type (X, L, T, S, 120 degree) in order to receive the correct type of trim.

CHAMFERED TRIM*

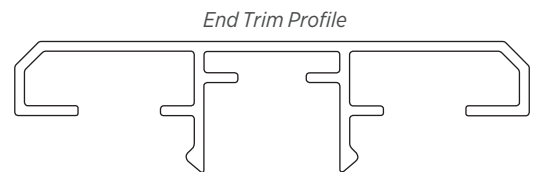
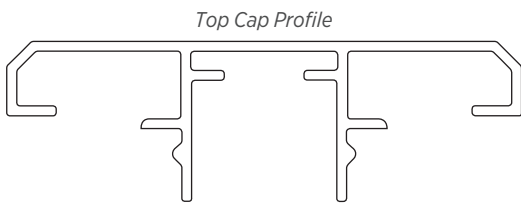

FLAT TRIM

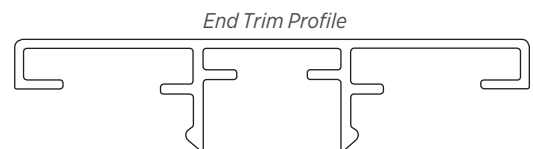
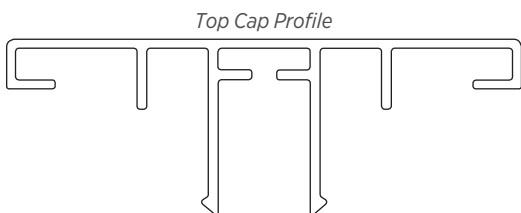

*Used on all products produced prior to July 2021.

ABOUND[®] TILE OVERVIEW

About tiles come in a variety of styles.

WORKSTATIONS

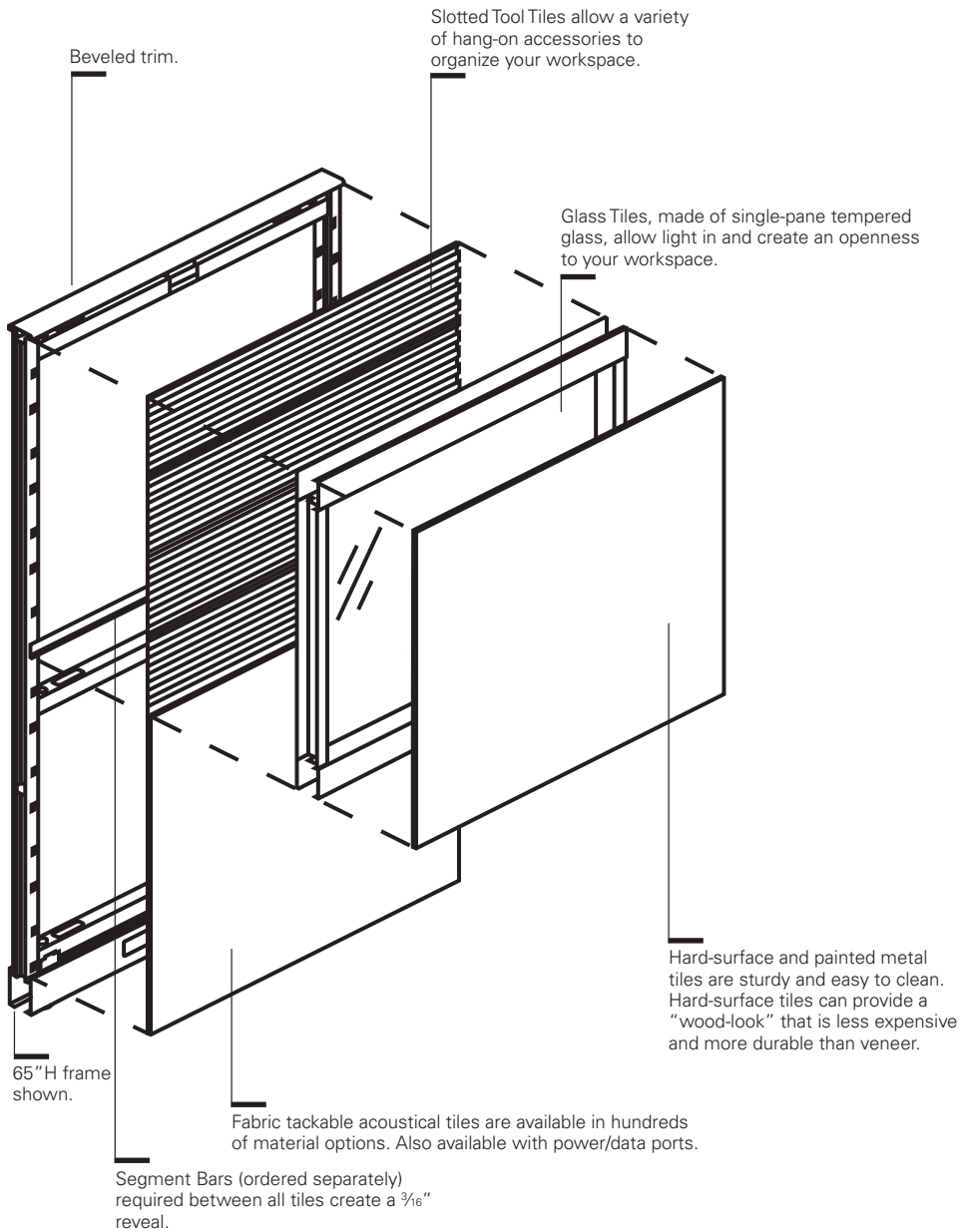

*Aesthetics of opposing tile surface and/or frame interior should be considered when selecting light-colored sheer materials.

ABOUT® SPECIFYING/DESIGN GUIDE

Tile Heights

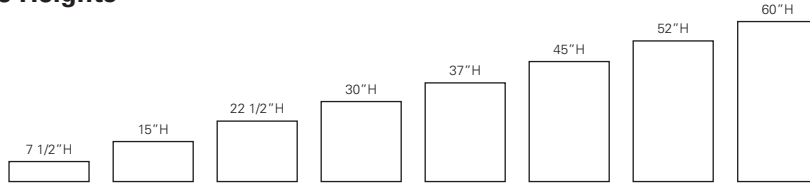

Monolithic tiles are 5" shorter than frame heights to account for top trim and base raceway.

Typical Tile Height Configurations

Segment bars are required between any two tiles — order separately based on tile configuration on each side of frame. Note: Most CAD specification programs will calculate quantity of segment bars required.

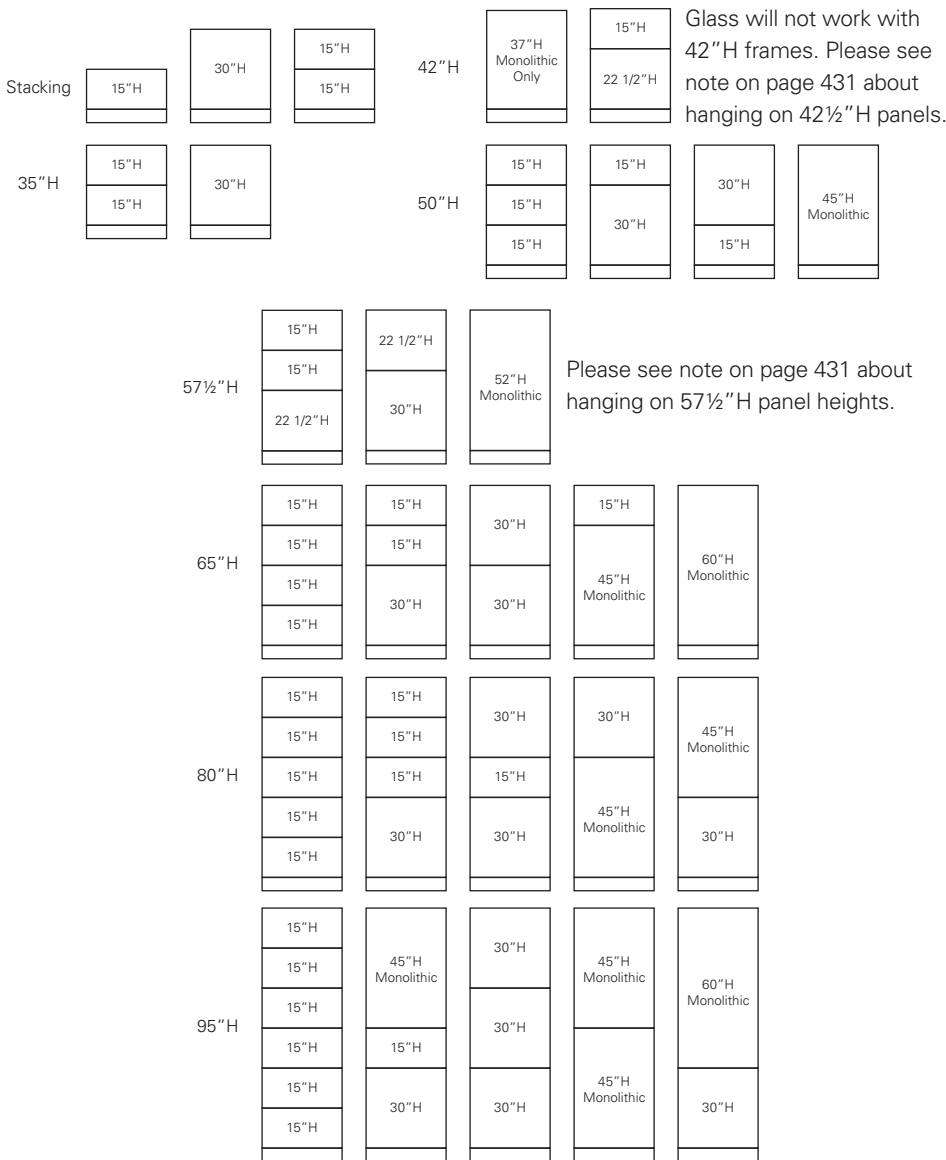

*Additional tile combinations to those shown above are possible; heights above 65" require stacking frames - maximum height is 110."

To calculate the total height of tiles(s) required, deduct 5" (height of base/top trim) from the total nominal panel height.

EXAMPLE: 65" H Frame takes 2 30" H tiles. $65 - 5 = 2 \times 30$ or $45 + 15$

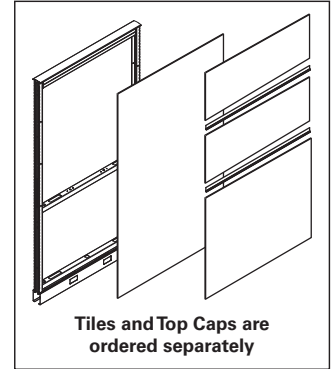

Tiles can be ordered in the size that matches the frame height plus the stacker height.

EXAMPLE: If you are using a 35" H frame plus a 30" H stacker, you can order 2 - 30" H tiles or 1 - 60" H tile.

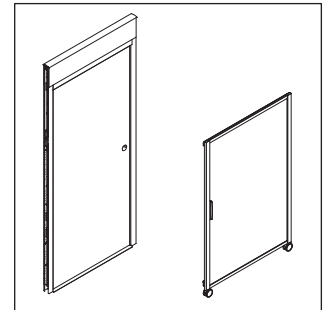

Door panels include frame, 42" W door, hinges and attaching hardware. Two 7 1/2" H fabric tiles for the top of the door frame are required and ordered separately (HRVDO742T).

Sliding doors are available in 50", 65", and 80" H models and can mount to 30", 36", 42", and 48" W panels. The doors provide a 36" W opening and are 42" W, nominally. The doors ship non-handed. A Mounting Bracket Kit must be ordered for each door corresponding to the mounting panel's width (30", 36", 42", or 48" W).

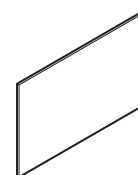

Hard-surface Tiles include tile and Custom Bracket Kit.

ABOUND[®] SPECIFYING/DESIGN GUIDE

WORKSTATIONS

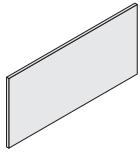

Fabric Tackable Acoustical Tile

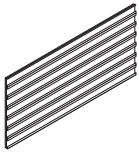

Slotted Tool Tile

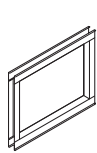

Glass Tile

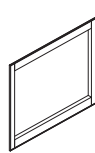

Pass-thru Tile

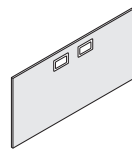

Fabric Tackable Acoustical Ported Tile

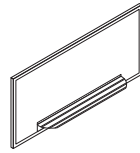

Markerboard Tile
*Markerboard tray ordered separately

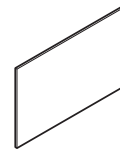

Hard-surface Tiles

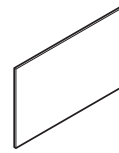

Painted Metal Tile

Tiles — Tackable Acoustical, Tackable Acoustical/Ported

| | 24"W | 30"W | 36"W | 42"W | 48"W | 60"W |
|----------|------|------|------|------|------|------|
| 7 1/2"H | | | | | | |
| 15"H | | | | | | |
| 22 1/2"H | | | | | | |
| 30"H | | | | | | |
| 37"H | | | | | | |
| 45"H | | | | | | |
| 52"H | | | | | | |
| 60"H | | | | | | |

Glass Tile Kits, Markerboard, Painted Metal Tiles

| | 24"W | 30"W | 36"W | 42"W | 48"W | 60"W |
|------|------|------|------|------|------|------|
| 15"H | | | | | | |
| 30"H | | | | | | |

Pass-thru Tiles

| | 24"W | 30"W | 36"W | 42"W | 48"W | 60"W |
|------|------|------|------|------|------|------|
| 30"H | | | | | | |

Slotted Tool Tile

| | 24"W | 30"W | 36"W | 42"W | 48"W | 60"W |
|------|------|------|------|------|------|------|
| 15"H | | | | | | |

Hard-surface Tiles

| | 24"W | 30"W | 36"W | 42"W | 48"W | 60"W |
|------|------|------|------|------|------|------|
| 15"H | | | | | | |
| 30"H | | | | | | |
| 37"H | | | | | | |

TILES

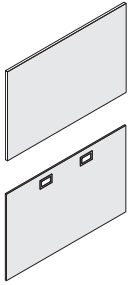

Tackable Acoustical Fabric Tiles

- Tiles do not include segment bars — order separately.

Port Tiles

- Receptacle openings with blank covers (1 in 24"W tiles; 2 in wider tiles). Located 30" above bottom of base raceway and 10½" from the edge of the frame.
- Tiles do not include segment bars — order separately.
- 30"H ported tiles on 35"H frame will need additional stiffener support.
- Ported tiles should only be used to accommodate beltline height. If a port is needed at an alternate height, please submit a special request.
- Tiles cannot be flipped to move data ports.
- Duplex brackets must be specified for ported tiles.

Painted Metal

- Tiles do not include segment bars — order separately.
- Painted steel construction.
- 15"H and 30"H tiles are non-dedicated and can be used in any tile position.
- Tiles can accept magnets.

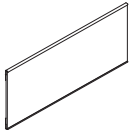

Tool Tiles

- Tiles do not include segment bars — order separately.
- Sturdy aluminum extrusion with steel support construction.
- Powder coated for durable finish.
- Work tools available.
- Use in place of standard 15"H tiles.
- Cannot be used in the bottom location of a panel frame or on wall track.
- Each tool tile has a suggested weight capacity of 80 lbs. of paper management accessories.

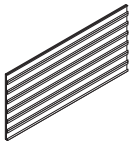

Pass-Thru Tiles

- Pass-thru opening is 22½"H.
- Used as 30"H tile.
- Must order quantity of one 7½"H tile if finishing one side and quantity of two 7½"H tiles if finishing both sides.
- No segment bar needed above tile.
- Built into trim pieces.

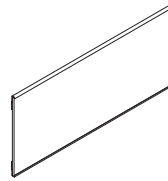
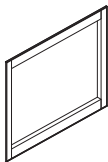

Hard Surface

- High Pressure Laminate — available in standard laminate colors.
- Tiles do not ship with segment bars — order separately.
- Tiles come completely assembled and attach with custom tile bracket kit. Specify paint color.
- 15"H, 30"H, and 37"H tiles are non-dedicated and can be used in any tile position.
- Vertical grain on all tile sizes.

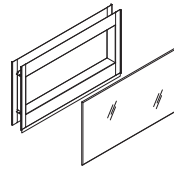

Glass Tiles

- Clear and frosted glass.
- Clear glass is writeable with dry erase marker — frosted glass is not.
- Tempered safety glass encased within a frame.
- Single-pane construction, glass is flush on one side.
- Glass opening is 4" less than nominal heights and widths.
- Cannot be used in top tile position of a 42½"H panel frame or any frame with integrated power pole.
- Cannot be used at the bottom or beltline location of panel frame.
- 30"H glass tiles can only be placed in top position of 65"H frames or only in 30"H stacking frame. Segment bar needs to be ordered.

Marker Board Tiles

- White marker board tile; painted steel surface.
- Accepts magnetic accessories.
- 15"W magnetically attachable tray is natural aluminum color — order separately.
- 15"H and 30"H tiles are non-dedicated and can be used in any tile position.

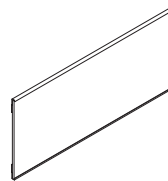

Gallery Panels

- 1½" thick laminate panels used as wing or end of run panels only.
- Available in 35"H, 42½"H, and 50"H options.
- Options available to include frameless glass.
- Gallery Panel connectors purchased separately.

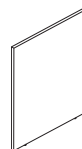

Custom Material Bracket Kit

- Do not ship with segment bars — order separately.
- Used with Customer's Own Material — thickness is ¼".
- Contact HON for insert dimensions.

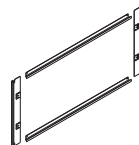

ABOUND® GALLERY PANELS OVERVIEW

GALLERY PANELS

Abound® Gallery Panels are an affordable, sleek way to incorporate laminate wing and end of run panels where power is not needed. The simplistic design provides a great new way to add woodgrains or solid laminate finishes to your workstation allowing for greater customization and value engineering.

BASIC CHARACTERISTICS

- Available in L-, T-, and Mid-configurations.
- Made of 1 1/8" board with high-pressure laminate.
- Use 1/8" thickness for space planning.
- Can be specified with matching or contrasting edge colors.
- Available in woodgrain and solid laminates.
- Woodgrain laminates can be specified with vertical grain on panels from 24" to 60"W.
- Horizontal grain available on all panel sizes.
- Gallery Panels offer 2 1/2" leveling capacity.
- Overall heights line up with adjacent panel.
- Available with and without integrated glass options (specified separately).
- Gallery Panels for use with glass have separate model numbers.
- All configurations are non-handed and secured using hidden fasteners.
- Standard Gallery Panels cannot connect to each other, you must use Gallery-to-Gallery Panels for connections.
- Additional support is required after every 60" in Gallery Panel width (i.e., storage or workstation tie-in).
- Gallery Panel widths are true to size.
- Please adhere to all standard systems specification guides.

GALLERY PANEL OFFERING

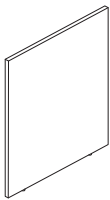

Wing End of Run
42"H, 50"H x 27", 33", 39", 45", 51", 63"W
Wing Middle of Run
42"H, 50"H x 24", 30", 36", 42", 48", 60"W
Spanning End of Run
42"H, 50"H x 51", 63", 75"W

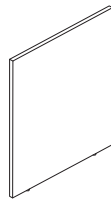

Wing End of Run, Glass
42"H, 50"H x 27", 33", 39", 45", 51", 63"W
Wing Middle, Glass
42"H, 50"H x 24", 30", 36", 42", 48", 60"W
Spanning End of Run, Glass
42"H, 50"H x 51", 63", 75"W

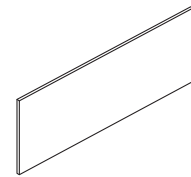

Wing End of Run, Glass
7 1/2"H x 27", 33", 39", 45", 51", 63"W
Wing Middle, Glass
7 1/2"H x 24", 30", 36", 42", 48", 60"W
Spanning End of Run, Glass
7 1/2"H x 51", 63", 75"W

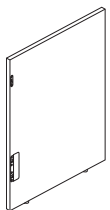

Gallery-to-Gallery, L-Connection
35"H, 42"H, 50"H x 18", 24", 30", 36", 42", 48", 60"W
Gallery-to-Gallery, L-Connection, Glass
35"H, 42"H, 50"H x 18", 24", 30", 36", 42", 48", 60"W

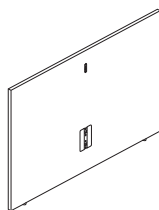

Gallery-to-Gallery, T-Connection
35"H, 42"H, 50"H x 18", 24", 30", 36", 42", 48", 60"W
Gallery-to-Gallery, T-Connection, Glass
35"H, 42"H, 50"H x 18", 24", 30", 36", 42", 48", 60"W

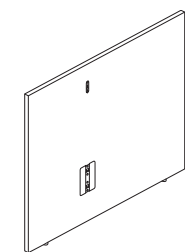

Gallery-to-Gallery, Non-Symmetrical Connection
35"H, 42"H, 50"H x 18", 24", 30"W
Gallery-to-Gallery, Non-Symmetrical, Glass
35"H, 42"H, 50"H x 18", 24", 30"W

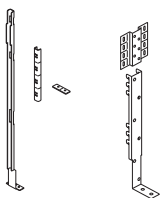

Gallery Panel Connectors
Spanning End of Run, L Connectors, and Wing Middle Brackets



Gallery Connector ("Block and Trim" Kit)
For 35"-65"H Panels

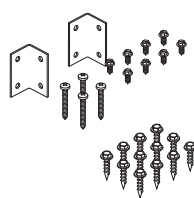

Gallery to Metal/Laminate Kits

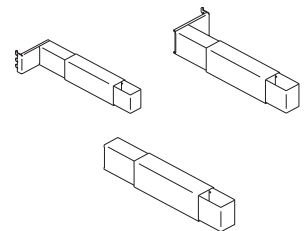

Height Adjustable Tie-In Brackets

ABOUND[®] GALLERY PANELS OVERVIEW

GALLERY PANELS DIMENSIONS

Gallery Panel Widths

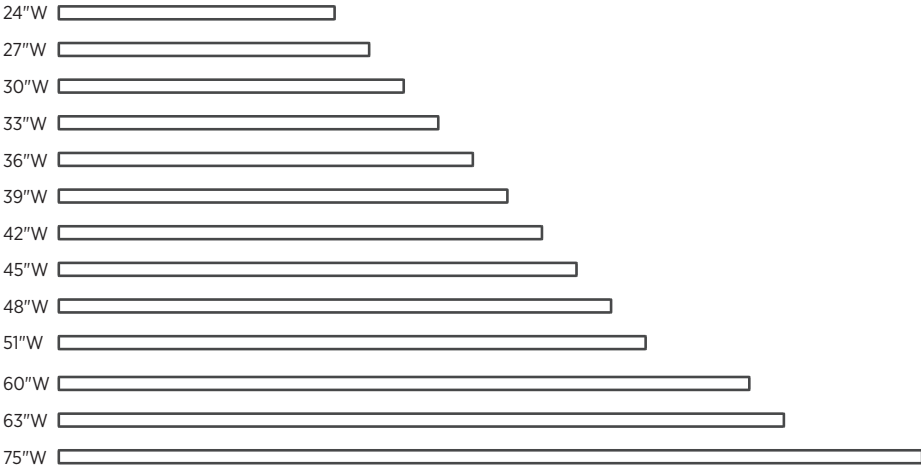

Gallery Panel Heights

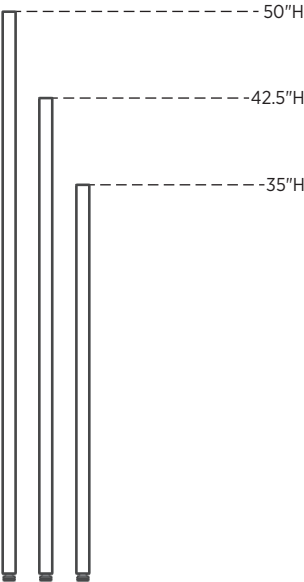

WORKING WITH INTEGRATED GLASS

- Gallery Panels for use with glass offer a routed top edge.
- Glass mounts directly into the Gallery Panel route via a gasket.
- The routing is inset 1½" from each end of the panel on standard Gallery Panels.
- Total glass width will be 3" narrower than the Gallery Panel.
- Glass height is available in 7½"H.
- Glass is available on all Gallery Panel widths.
- Specify glass models separate from Gallery Panel models.
- Routing is inset ½" on L and T Gallery Panels.

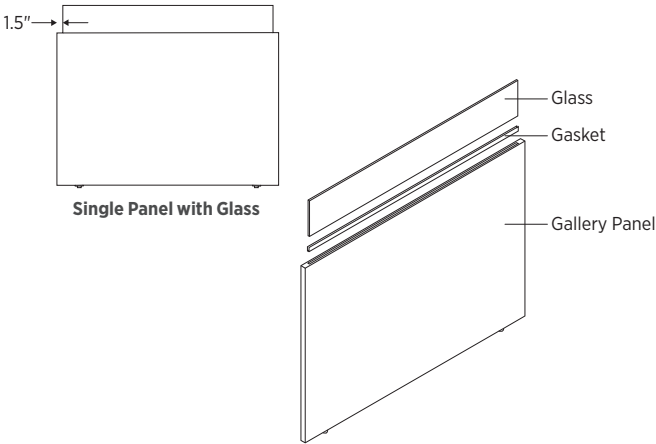

ABOUND® GALLERY PANELS OVERVIEW

T-CONFIGURATION

- Provides privacy to one or both ends of the Abound® system in a dual-sided application.
- All T-configurations connect using HRVCE connector kit.
- When the system panel is higher than the Gallery Panel, a variable height system's trim must be specified to finish off the exposed frame.
- T-configuration can be used for off-modular planning. The HRVCE connector kit location must be field measured.
- Accommodate for 2⁵/₈" frame thickness when planning with Abound® panel system.

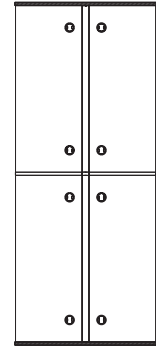
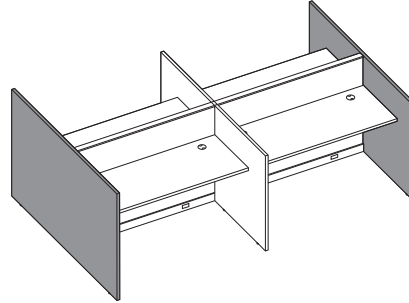

L-CONFIGURATION

- Provides privacy to one or both ends of the system in a single-sided application.
- L-configuration caps over the system panel.
- Due to the thickness of the Abound® panel L-configuration overhangs by approximately 3/16" on both sides.
- Accommodate for 2⁵/₈" frame thickness planning with Abound® panel system.
- All L-configuration Gallery Panels require the connector kit HRVCE to attach to the parent run.
- When the system panel is higher than the Gallery Panel, the variable height system's trim must be specified to finish off exposed frame.

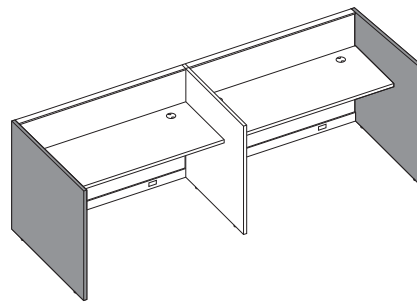

MID-CONFIGURATION (SINGLE-SIDED OR DUAL-SIDED)

- Mid-configuration panel does not overlap parent system panel.
- When specifying mid-configuration panels, one Gallery Panel "block and trim" kit (HRVCXXGP) is required to space the system panels out 1¹/₈". Kits include: Connector blocks, vertical trim, and a top cap.
- "Block and trim" models must match the height of the parent run.
- Specify one mid-connector kit (HRVCM) per Gallery Panel to attach to parent run. Gallery Panel and mid-connector kit attach over "block and trim" kit. Dual-sided application requires two connector kit models.
- When using a mid-configuration Gallery Panel, both panel frames in the spine must be of equal height.
- Mid-configuration Gallery Panel may exceed the height of the parent run by a maximum of 15".
- Trims can be painted to match the system panel trims.

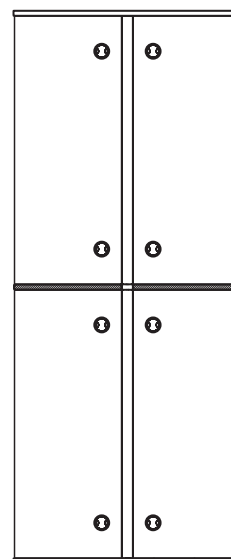

Dual-Sided Configuration

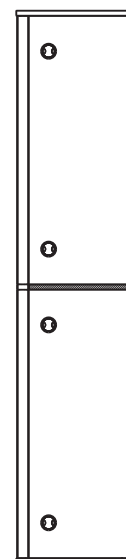

Single-Sided Configuration

ABOUT® GALLERY PANELS OVERVIEW

STORAGE AND WORKSURFACE CONNECTORS

- Use HRVGLSK to connect to laminate storage or HRVGMSK for metal storage.
- To connect to worksurfaces use HSTB2W1 bracket when used in perpendicular to parent run or use standard systems cantilever brackets when used in parallel to parent run in panel systems.

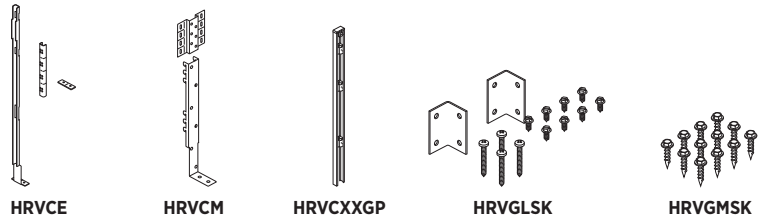

PANEL SYSTEMS

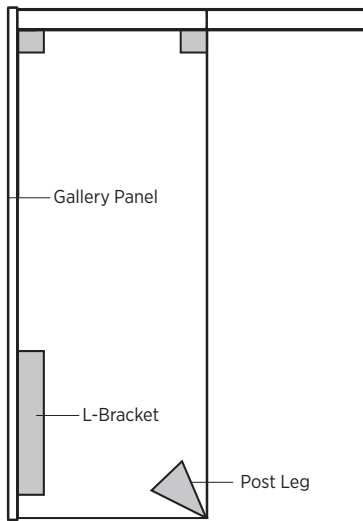

Perpendicular panel system with L-bracket (HSTB2W1) and post leg.

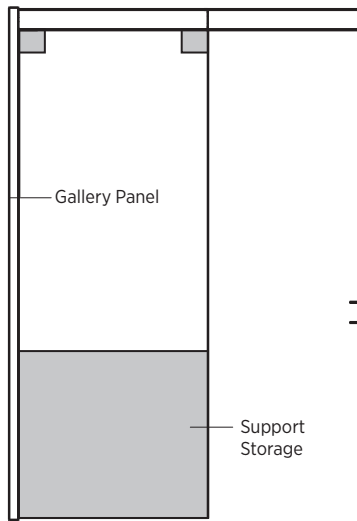

Perpendicular panel system with storage support.

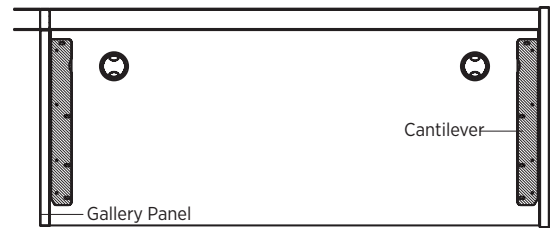

Panel system with cantilever support.

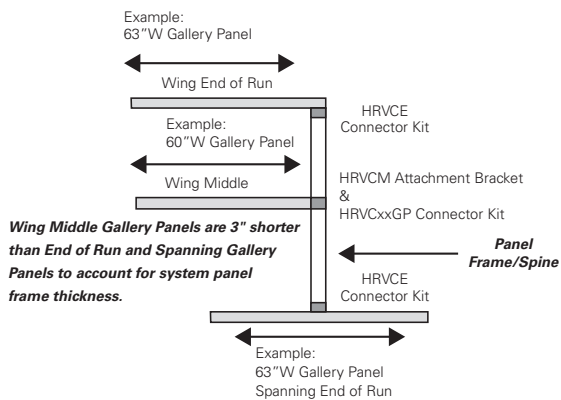

ABOUND® GALLERY PANELS OVERVIEW

GALLERY-TO-GALLERY PANELS

- Gallery-to-Gallery Panels connect to other Gallery Panels and are available in L-, T-, and Non-symmetrical T-configurations.
- When specifying Gallery-to-Gallery Panels, the installation template HRVGTGG is required. The recommendation is one template for every 30 panels.
- Gallery-to-Gallery Panels must be of equal or lower height than the Standard Gallery Panel attached. The Gallery-to-Gallery Panel cannot be taller than the adjacent panel. If this is needed, please reach out to Tailored Solutions for a custom solution.
- Made of 1½" board with HPL laminate.
- Can be specified with matching or contrasting edge.
- Edgeband is 2mm ABS.
- Available in woodgrain and solid laminates.
- Woodgrain laminates can be specified with vertical grain up to 48"W.
- Gallery-to-Gallery Panel widths are available in 18", 24", 30", 36", 42", 48", 60"W, and 72" (T).
- Gallery Panels offer 2½" leveling capability.
- Overall heights line up with adjacent panel.
- Gallery-to-Gallery Panels cap over Standard Gallery Panels and are oversized by 1½" to maintain true interior dimensions.
- Available with or without the integrated glass option.
- Glass is specified separately. Use mid-connection glass.
- Gallery Panels for use with glass have separate model numbers.
- Gallery-to-Gallery Panels are secured with an inset flat bracket under a painted metal cover. Paint color is specifiable to blend in with laminate choice.
- L-panels are handed.
- Non-symmetrical T-panels vary in size on either side of the adjacent panel.
- Please adhere to all standard systems specification guidelines.
- Additional support is required after every 60" in Gallery Panel width (i.e., a storage or worksurface tie-in).

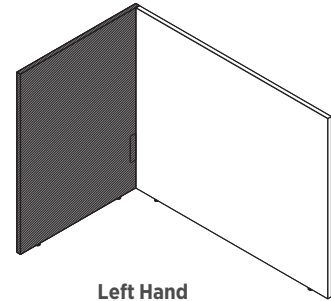

Left Hand

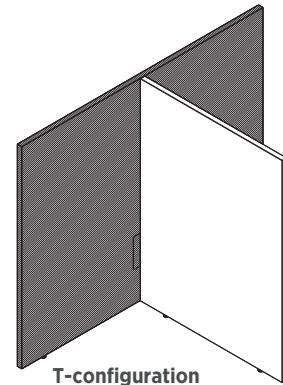

T-configuration

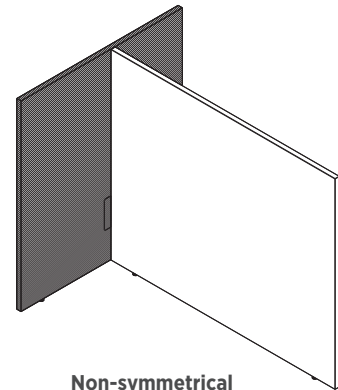

Non-symmetrical

ABOUT® GALLERY PANELS OVERVIEW

GALLERY-TO-GALLERY FREESTANDING SCREENS

Freestanding screens can be created using Standard Gallery Panels and Gallery-to-Gallery Panels. All Gallery Panel heights are allowed. Increase minimum return length by 3" (or next largest width) of panel for every 7½" variation in panel height.

Freestanding L-Screens

| Parent | Minimum Return* |
|----------|-----------------|
| 30"-36" | 30" |
| >42"-60" | 36" |
| 60"-75" | 42" |

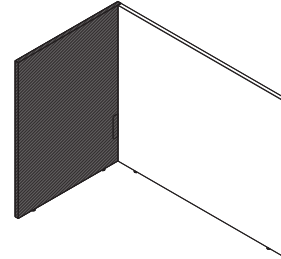
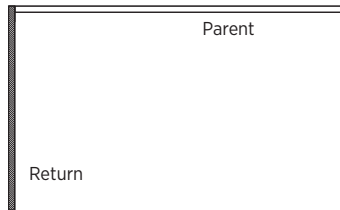

* 18"-24" not valid

Freestanding U-Screens

| Parent | Minimum Return* |
|---------|-----------------|
| 24"-48" | 24" |
| 60"-75" | 30" |

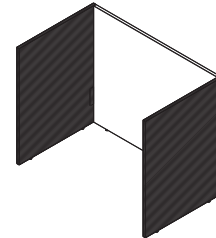
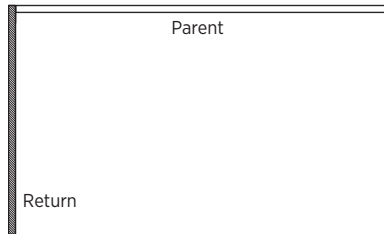

* 18"-24" not valid

Freestanding T-Screens

| Parent | Minimum Return* |
|---------|-----------------|
| 30"-75" | 30" |
| 36"-75" | 36" |
| 42"-72" | 42" |

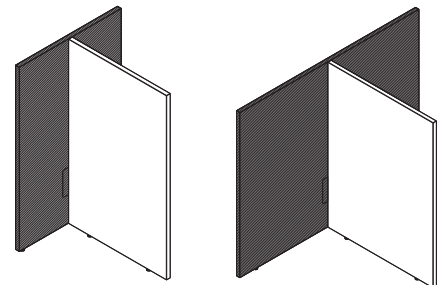
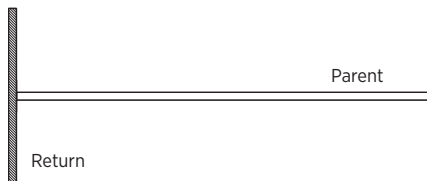

* 18"-24" not valid

Freestanding H-Screens

| Freestanding T (Dual-Sided) | |
|-----------------------------|----------------|
| Parent | Minimum Return |
| 30"-60" | 18" |

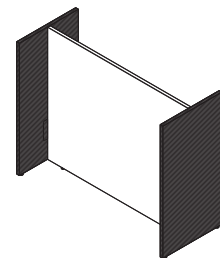
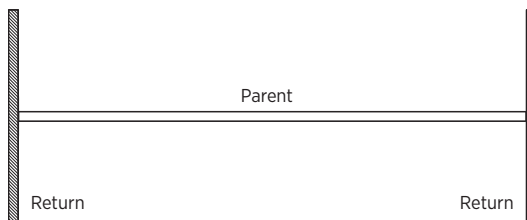

NOTES: Increase minimum return length by 3" or next largest width of panel for every 7½" variation in panel height.

ABOUND® SYSTEMS

Electrical and Data

About String-in Capacity

Openings in frame sides permit electrical data and communication cables to be run between frames in Abound. Using tackable acoustical tiles, the beltline pathway accommodates up to 62 cables (.25" dia) or 46 cables with electrical components installed.

DO NOT run electrical equipment or extension cords through cable openings in frame sides. Use beltline or base-mounted electrical system for all electrical supply.

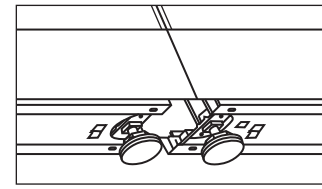
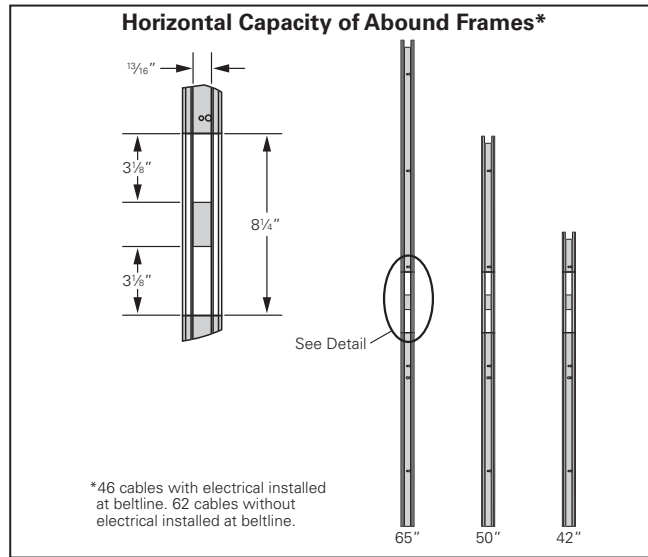

Cables can enter/exit panel through underside of base pathway at juncture between frames. Openings are sized as follows (in sq. in.):

| | |
|----------------------------------|------|
| Straight connection | 6.0 |
| "S" Extended Straight Connection | 10.0 |
| "L" 90° Connection | 8.9 |
| "T" Connection | 15.9 |
| "X" Connection | 17.9 |
| "Y" Connection | — |

Vertical Capacity

Vertical Capacity Through Panel Frames

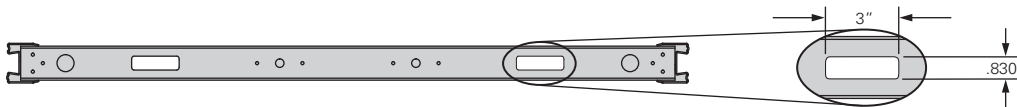

When leveling glides are fully retracted, panel-to-floor clearance is 7/16". This may affect the volume of cabling that can be fed into the frame from the bottom of the pathway.

- A 60% fill ratio is achievable; however, when electrical components are installed in the beltline area, cabling capacity through the beltline area will be limited to approximately 45% fill ratio.

| | Panel Width | Qty of .25" Cables at 45% Fill Ratio | Qty of .25" Cables at 60% Fill Ratio | Total Space (sq. in.) |
|--------|-------------|--------------------------------------|--------------------------------------|-----------------------|
| Abound | 24" - 60"W | 48 | 64 | 5.26 |

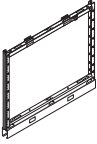
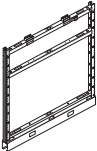
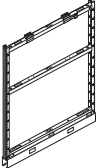
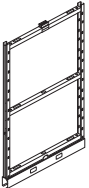
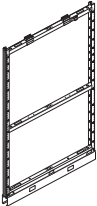

ABOUND® Panel Frames

| | DESCRIPTION | MODEL | SHIP WEIGHT | CUBE | LIST PRICE BY PAINT GRADE | |
|---|---|-----------|-------------|------|---------------------------|-------|
| | | | | | P1 | P2 |
|  | 35" H Panel Frame | | | | | |
| | 35" H x 24" W | HRVF3524P | 8 | 1.7 | \$258 | \$294 |
| | 35" H x 30" W | HRVF3530P | 11 | 2.1 | \$265 | \$301 |
| | 35" H x 36" W | HRVF3536P | 13 | 2.4 | \$271 | \$307 |
| | 35" H x 42" W | HRVF3542P | 16 | 2.8 | \$281 | \$317 |
| | 35" H x 48" W | HRVF3548P | 18 | 3.2 | \$298 | \$334 |
| | 35" H x 60" W | HRVF3560P | 23 | 4.0 | \$330 | \$366 |
|  | 42" H Panel Frame | | | | | |
| | 42" H x 24" W | HRVF4224P | 11 | 2.0 | \$265 | \$301 |
| | 42" H x 30" W | HRVF4230P | 14 | 2.4 | \$276 | \$312 |
| | 42" H x 36" W | HRVF4236P | 17 | 2.9 | \$281 | \$317 |
| | 42" H x 42" W | HRVF4242P | 19 | 3.4 | \$299 | \$335 |
| | 42" H x 48" W | HRVF4248P | 22 | 3.8 | \$313 | \$349 |
| | 42" H x 60" W | HRVF4260P | 28 | 4.7 | \$349 | \$385 |
| | <p>ⓘ When stacking on 42½" H frames, panel slots will be off by ½" compared to any other height panel.</p> <p>ⓘ When stacking on 42½" H frames, hanging accessories will be ½" off in height compared to accessories hanging on panels at any height other than 42½" H.</p> | | | | | |
|  | 50" H Panel Frame | | | | | |
| | 50" H x 24" W | HRVF5024P | 14 | 2.3 | \$284 | \$320 |
| | 50" H x 30" W | HRVF5030P | 17 | 2.9 | \$298 | \$334 |
| | 50" H x 36" W | HRVF5036P | 20 | 3.4 | \$298 | \$334 |
| | 50" H x 42" W | HRVF5042P | 24 | 4.0 | \$316 | \$352 |
| | 50" H x 48" W | HRVF5048P | 27 | 4.5 | \$324 | \$360 |
| | 50" H x 60" W | HRVF5060P | 34 | 5.6 | \$356 | \$392 |
|  | 57½" H Panel Frame | | | | | |
| | 57½" H x 24" W | HRVF5724P | 17 | 2.7 | \$296 | \$332 |
| | 57½" H x 30" W | HRVF5730P | 22 | 3.3 | \$306 | \$342 |
| | 57½" H x 36" W | HRVF5736P | 25 | 4.0 | \$309 | \$345 |
| | 57½" H x 42" W | HRVF5742P | 30 | 4.6 | \$326 | \$362 |
| | 57½" H x 48" W | HRVF5748P | 35 | 5.2 | \$339 | \$375 |
| | 57½" H x 60" W | HRVF5760P | 43 | 6.5 | \$368 | \$404 |
|  | 65" H Panel Frame | | | | | |
| | 65" H x 24" W | HRVF6524P | 17 | 3.0 | \$307 | \$343 |
| | 65" H x 30" W | HRVF6530P | 22 | 3.7 | \$313 | \$349 |
| | 65" H x 36" W | HRVF6536P | 25 | 4.4 | \$318 | \$354 |
| | 65" H x 42" W | HRVF6542P | 30 | 5.1 | \$331 | \$367 |
| | 65" H x 48" W | HRVF6548P | 35 | 5.8 | \$351 | \$387 |
| | 65" H x 60" W | HRVF6560P | 43 | 7.2 | \$382 | \$418 |

NOTES:

- Includes frame, baserail covers, attaching hardware and bottom segment bar.
- Frames, top caps and tiles are ordered and shipped separately.
- Frames are 2½" thick with a 5" H baserail.
- Frames are standard with two adjustable leveling glides which can be adjusted from the bottom of the glide or from the interior of frame.
- Two wire and data management openings standard per raceway, 24" panel has one opening.
- Lay-in wire management available in base. Horizontal cable routing available at beltline.
- Lay-in top pathway provides additional data cabling capacity.
- For worksurfaces that can be used with both Abound® and Accelerate® systems, see pages 617-629.
- ⓘ Panels should not be used in unsupported applications or take the place of permanent walls. Panels are intended to be supported with floor supports and/or storage or tied in with worksurfaces. Refer to Specifying and Design Guide pages.

HOW TO SPECIFY

| | |
|----------------------------|--------------------------|
| Select Model Number | Select Trim Color |
| See page 423 | See page 423 |
| HRVF3524P | T4 |

ABOUND® Panel Frames

GSA SIN 33721



Icon Legend on page 19

WORKSTATIONS



| DESCRIPTION | FLAT MODEL | CHAMFERED MODEL | SHIP WEIGHT | CUBE | LIST PRICE BY PAINT GRADE | |
|----------------------|------------|-----------------|-------------|------|---------------------------|-------|
| | | | | | P1 | P2 |
| Panel Top Cap | | | | | | |
| 24"W | HRVTC24F | HRVTC24 | 1.6 | 0.3 | \$40 | \$60 |
| 30"W | HRVTC30F | HRVTC30 | 1.8 | 0.3 | \$50 | \$70 |
| 36"W | HRVTC36F | HRVTC36 | 2.0 | 0.3 | \$65 | \$85 |
| 42"W | HRVTC42F | HRVTC42 | 2.2 | 0.3 | \$68 | \$88 |
| 48"W | HRVTC48F | HRVTC48 | 3.4 | 0.4 | \$75 | \$95 |
| 54"W | HRVTC54F | HRVTC54 | 3.7 | 0.5 | \$92 | \$112 |
| 60"W | HRVTC60F | HRVTC60 | 3.9 | 0.6 | \$92 | \$112 |
| 66"W | HRVTC66F | HRVTC66 | 4.0 | 0.6 | \$109 | \$129 |
| 72"W | HRVTC72F | HRVTC72 | 5.3 | 0.8 | \$113 | \$133 |
| 78"W | HRVTC78F | HRVTC78 | 6.5 | 0.8 | \$118 | \$138 |
| 84"W | HRVTC84F | HRVTC84 | 6.7 | 0.9 | \$128 | \$148 |
| 90"W | HRVTC90F | HRVTC90 | 7.0 | 0.9 | \$134 | \$154 |
| 96"W | HRVTC96F | HRVTC96 | 7.2 | 0.9 | \$140 | \$160 |

NOTES: Top caps can span more than one panel in an in-line connection.

! Top cap models are to be used on Abound® frames only.

NOTES:

- Includes frame, baserail covers, attaching hardware and bottom segment bar.
 - Frames, top caps and tiles are ordered and shipped separately.
 - Frames are 2½" thick with a 5"H baserail.
 - Frames are standard with two adjustable leveling glides which can be adjusted from the bottom of the glide or from the interior of frame.
 - Two wire and data management openings standard per raceway, 24" panel has one opening.
 - Lay-in wire management available in base. Horizontal cable routing available at beltline.
 - Lay-in top pathway provides additional data cabling capacity.
 - For worksurfaces that can be used with both Abound® and Accelerate® systems, see pages 617-629.
- ! Panels should not be used in unsupported applications or take the place of permanent walls. Panels are intended to be supported with floor supports and/or storage or tied in with worksurfaces. Refer to Specifying and Design Guide pages.

HOW TO SPECIFY

| | |
|--|---|
| <p>Select Model Number</p> <p>HRVTC24</p> | <p>Select Trim Color</p> <p>See page 423</p> <p>T4</p> |
|--|---|

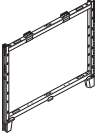
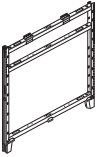
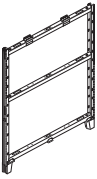
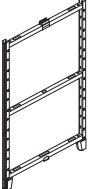
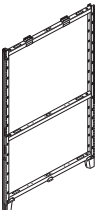
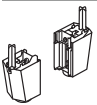

ABOUND® Open Base Panel Frames

| | DESCRIPTION | MODEL | SHIP WEIGHT | CUBE | LIST PRICE BY PAINT GRADE | |
|---|---|-----------|-------------|------|---------------------------|-------|
| | | | | | P1 | P2 |
|  | 35" H Open Base Panel Frame | | | | | |
| | 35" H x 24" W | HRFF3524P | 8 | 1.7 | \$258 | \$294 |
| | 35" H x 30" W | HRFF3530P | 11 | 2.1 | \$265 | \$301 |
| | 35" H x 36" W | HRFF3536P | 13 | 2.4 | \$271 | \$307 |
| | 35" H x 42" W | HRFF3542P | 16 | 2.8 | \$281 | \$317 |
| | 35" H x 48" W | HRFF3548P | 18 | 3.2 | \$298 | \$334 |
| | 35" H x 60" W | HRFF3560P | 23 | 4.0 | \$330 | \$366 |
|  | 42" H Open Base Panel Frame | | | | | |
| | 42" H x 24" W | HRFF4224P | 11 | 2.0 | \$265 | \$301 |
| | 42" H x 30" W | HRFF4230P | 14 | 2.4 | \$276 | \$312 |
| | 42" H x 36" W | HRFF4236P | 17 | 2.9 | \$281 | \$317 |
| | 42" H x 42" W | HRFF4242P | 19 | 3.4 | \$299 | \$335 |
| | 42" H x 48" W | HRFF4248P | 22 | 3.8 | \$313 | \$349 |
| | 42" H x 60" W | HRFF4260P | 28 | 4.7 | \$349 | \$385 |
| | <p>ⓘ When stacking on 42½" H frames, panel slots will be off by ½" compared to any other height panel.</p> <p>ⓘ When stacking on 42½" H frames, hanging accessories will be ½" off in height compared to accessories hanging on panels at any height other than 42½" H.</p> | | | | | |
|  | 50" H Open Base Panel Frame | | | | | |
| | 50" H x 24" W | HRFF5024P | 14 | 2.3 | \$284 | \$320 |
| | 50" H x 30" W | HRFF5030P | 17 | 2.9 | \$298 | \$334 |
| | 50" H x 36" W | HRFF5036P | 20 | 3.4 | \$298 | \$334 |
| | 50" H x 42" W | HRFF5042P | 24 | 4.0 | \$316 | \$352 |
| | 50" H x 48" W | HRFF5048P | 27 | 4.5 | \$324 | \$360 |
| | 50" H x 60" W | HRFF5060P | 34 | 5.6 | \$356 | \$392 |
|  | 57½" H Open Base Panel Frame | | | | | |
| | 57½" H x 24" W | HRFF5724P | 17 | 2.7 | \$296 | \$332 |
| | 57½" H x 30" W | HRFF5730P | 22 | 3.3 | \$306 | \$342 |
| | 57½" H x 36" W | HRFF5736P | 25 | 4.0 | \$309 | \$345 |
| | 57½" H x 42" W | HRFF5742P | 30 | 4.6 | \$326 | \$362 |
| | 57½" H x 48" W | HRFF5748P | 35 | 5.2 | \$339 | \$375 |
| | 57½" H x 60" W | HRFF5760P | 43 | 6.5 | \$368 | \$404 |
|  | 65" H Open Base Panel Frame | | | | | |
| | 65" H x 24" W | HRFF6524P | 17 | 3.0 | \$307 | \$343 |
| | 65" H x 30" W | HRFF6530P | 22 | 3.7 | \$313 | \$349 |
| | 65" H x 36" W | HRFF6536P | 25 | 4.4 | \$318 | \$354 |
| | 65" H x 42" W | HRFF6542P | 30 | 5.1 | \$331 | \$367 |
| | 65" H x 48" W | HRFF6548P | 35 | 5.8 | \$351 | \$387 |
| | 65" H x 60" W | HRFF6560P | 43 | 7.2 | \$382 | \$418 |
|  | Raceway to Open Base Conversion Kit | HRVFFOOT | 4 | 0.1 | \$186 | \$206 |

NOTES:

- Includes frame, attaching hardware and bottom segment bar.
- Tiles and top caps are ordered and shipped separately.
- Frames are 2½" thick with a 5" H open base.
- Frames are standard with two adjustable leveling glides which can be adjusted from the bottom of the glide.
- Horizontal cable routing available at beltline.

- Lay-in top pathway provides additional data cabling capacity.
- See page 446 for top cap options.
- For worksurfaces that can be used with Abound® and Accelerate® systems, see pages 617-629.
- ⓘ Panels should not be used in unsupported applications or take the place of permanent walls. Panels are intended to be supported with floor supports and/or storage or tied in with worksurfaces. Refer to Specifying and Design Guide pages.

HOW TO SPECIFY

| | |
|----------------------------|--------------------------|
| Select Model Number | Select Trim Color |
| See page 423 | See page 423 |
| HRFF3524P | T4 |

ABOUND® Stacking Panel Frames

GSA SIN 33721



Icon Legend on page 19

WORKSTATIONS



DESCRIPTION

15”H Stacking Panel Frame

15”H x 24”W
15”H x 30”W
15”H x 36”W
15”H x 42”W
15”H x 48”W
15”H x 60”W

MODEL

HRVF1524
HRVF1530
HRVF1536
HRVF1542
HRVF1548
HRVF1560

SHIP WEIGHT

8
10
12
14
16
20

CUBE

0.8
0.9
1.1
1.3
1.5
1.8

LIST PRICE

\$241
\$252
\$258
\$269
\$271
\$279

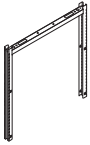

30”H Stacking Panel Frame

30”H x 24”W
30”H x 30”W
30”H x 36”W
30”H x 42”W
30”H x 48”W
30”H x 60”W

HRVF3024
HRVF3030
HRVF3036
HRVF3042
HRVF3048
HRVF3060

10
12
14
16
18
22

1.4
1.8
2.1
2.4
2.8
3.4

\$254
\$269
\$277
\$288
\$293
\$311

Full Segment Bars

24”W
30”W
36”W
42”W
48”W
60”W

HRVFSB24
HRVFSB30
HRVFSB36
HRVFSB42
HRVFSB48
HRVFSB60

2
2
3
3
3
4

0.4
0.4
0.5
0.5
0.6
0.7

\$24
\$24
\$25
\$26
\$27
\$28

! Must order one segment bar per panel reveal, per panel side.

NOTES:

- Frames, top caps and tiles are ordered and shipped separately.
- Includes attachment hardware.
- Stacking frames can be added to the top of any 35”H, 50” or 65”H frame.
- No paint selection necessary on stacking frames.
- Overhead storage units can be suspended from stacking frames. See pages 584-585.
- Segment Bars do not need to be specified for monolithic tiles, when only a single tile is attached to the frame.

- ! When stacking on 42½”H frames, panel slots will be off by ½” compared to any other height panel.
- ! When stacking on 42½”H frames, hanging accessories will be ½” off in height compared to accessories hanging on panels at any height other than 42½”H.
- ! Not designed to combine differing frame widths in a single stack.
- ! Stacking frames not designed to be used as a base frame.
- ! Segment bars available in Black only.
- ! Segment Bars are formed, steel cross members and are required between tiles and on each side of the frame.

HOW TO SPECIFY

Select
Model Number

HRVF1524



ABOUND® Stiffener Supports



DESCRIPTION

Stiffener Support

24"W
30"W
36"W
42"W
48"W
60"W

MODEL

HRVSS24
HRVSS30
HRVSS36
HRVSS42
HRVSS48
HRVSS60

SHIP WEIGHT

1
1
4
4
4
4

CUBE

0.4
0.4
0.5
0.5
0.5
0.7

LIST PRICE

\$63
\$65
\$69
\$85
\$96
\$104

! Black only. No need to specify paint.

NOTES:

- Tile stiffener supports can be used to increase the stiffness of a panel and can also be used to mount power/data anywhere vertically on an Abound frame. Can only be used when there are fabric tiles on both sides of the frame.
- Self-drilling screws included.

! Black only. No need to specify paint.

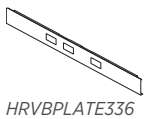

HRVBPLATE336

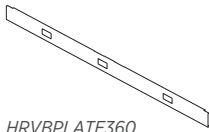

HRVBPLATE360

DESCRIPTION

Abound® Base Pathway Cover w/Additional Knockout

36"W
42"W
48"W
60"W

MODEL

HRVBPLATE336
HRVBPLATE342
HRVBPLATE348
HRVBPLATE360

SHIP WEIGHT

7 Ⓞ
8 Ⓞ
9 Ⓞ
11 Ⓞ

CUBE

0.4
0.4
0.4
0.5

LIST PRICE BY PAINT GRADE

P1

\$81
\$83
\$86
\$99

P2

\$91
\$93
\$96
\$109

NOTES: Specify paint, see page 423.

SPECIFYING EXAMPLE: HRVBPLATE336.T4

NOTES:

- ! Specify Pathways to match trim color.
- ! Standard raceways with two knockouts are standard on panels. If additional three knockout kickplate is ordered, the two port version can be saved or discarded.

HOW TO SPECIFY

| | |
|--|--|
| <p>Select Model Number</p> <p>HRVBPLATE336 . T4</p> | <p>Select Paint Color</p> <p>See page 423</p> |
|--|--|

ABOUND® Panel Door

GSA SIN 33721



Icon Legend on page 19

WORKSTATIONS



| DESCRIPTION | MODEL | SHIP WEIGHT | CUBE | L1 LIST PRICE BY PAINT GRADE | |
|--|------------------|-------------|------|------------------------------|---------------|
| | | | | P1 | P2 |
| Door Panel — Laminate 42"W x 95"H NOTES: Includes frame, 42"W door, hinges and attaching hardware. Lockset or Knob ordered separately. Best placement of a door is at an L, T, X connector or wall starter connector for rigidity. Use of spanning top caps at an in-line will also help add additional rigidity. | HRVD9542P | 155 | 5.4 | \$2478 | \$2514 |
| ! Two HRVD0742T tiles for above the door must be ordered per each door ordered. See below. ! Top Cap must be ordered separately. See page 446 for top cap specification. | | | | | |



HOW TO SPECIFY

| | | |
|---|--|--|
| Select Model Number HRVD9542P | Select Trim Color See page 423 T4 | Select Door Laminate L1 Woodgrain only See page 423 K2 |
|---|--|--|

| DESCRIPTION | MODEL | SHIP WEIGHT | CUBE | LIST PRICE BY FABRIC GRADE | | | | | | |
|--|------------------|-------------|------|----------------------------|-------------|--------------|--------------|--------------|--------------|--------------|
| | | | | A | B | C | D | E | F | G |
|  Fabric Tiles for Door Panel 7½"H x 42"W ! Must be ordered with the Door Panel model above. ! Required for door installation. ! Two tiles must be ordered for installation. Tiles ship 1/pkg. | HRVD0742T | 3 | 1.2 | \$93 | \$97 | \$101 | \$111 | \$114 | \$118 | \$122 |

HOW TO SPECIFY

| | |
|---|--|
| Select Model Number HRVD0742T | Select Fabric Color See pages 424-425 APN15 |
|---|--|

| | DESCRIPTION | MODEL | SHIP WEIGHT | CUBE | LIST PRICE |
|--|--|-----------------|-------------|------|--------------|
|  | Lockset (Door Knob) Polished Brass, keyed on one side | HN899900 | 2.0 | 0.1 | \$126 |
|  | Door Lever Brushed Aluminum, keyed on one side | HN899910 | 2.0 | 0.1 | \$347 |
|  | Carpet Grippers NOTES: Used with Glide Towers Shipped 12 per package No need to specify finish | HICG12 | 0.5 | 0.1 | \$23 |

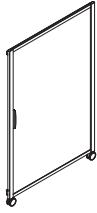

ABOUND[®] Sliding Door

**DESCRIPTION****Abound Sliding Door**

50"H x 42"W

65"H x 42"W

80"H x 42"W

MODEL**HH15042SD****HH16542SD****HH18042SD****SHIP
WEIGHT**

28

38

46

CUBE

5.5

7.1

8.6

LIST PRICE BY PAINT GRADE**P1****\$2266****\$2583****\$3160****P2****\$2302****\$2619****\$3196**

! Door is only available in Frosted Translucent Acrylic. Specify paint for frame.

! Can only install Sliding Door at the end of a run, not at a corner.

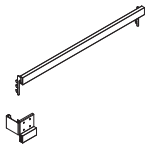
**Mounting Kit for Abound Sliding Door**

For 30"W Panel

For 36"W Panel

For 42"W Panel

For 48"W Panel

HHKDMK30**HHKDMK36****HHKDMK42****HHKDMK48**

4

5

6

7

0.4

0.5

0.5

0.5

\$196**\$205****\$211****\$222****\$208****\$217****\$223****\$234**

NOTES: Specify paint.

NOTES:

- The Sliding Doors are available in 50", 65", and 80"H models and can mount to 30", 36", 42", and 48"W panels.
- All doors are 42" wide, provide a 36"W opening, and are non-handed.

! A Mounting Bracket Kit must be ordered for each door corresponding to the mounting panels width (30", 36", 42", or 48"W).

HOW TO SPECIFY
**Select
Model Number**

| | | | | | | | | |
|---|---|---|---|---|---|---|---|---|
| H | H | 1 | 5 | 0 | 4 | 2 | S | D |
|---|---|---|---|---|---|---|---|---|

**Select
Paint Color**

See page 423

| | |
|---|---|
| T | 1 |
|---|---|

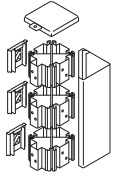

| DESCRIPTION | FLAT MODEL | CHAMFERED MODEL | SHIP WEIGHT | CUBE | LIST PRICE BY PAINT GRADE | |
|----------------------------------|------------|-----------------|-------------|------|---------------------------|-------|
| | | | | | P1 | P2 |
| "L" 90° Painted Connector | | | | | | |
| 7"H Frame | HRVC7PLF | HRVC7PL | 1 | 0.1 | \$105 | \$122 |
| 15"H Frame | HRVC15PLF | HRVC15PL | 2 | 0.1 | \$118 | \$135 |
| 22"H Frame | HRVC22PLF | HRVC22PL | 2 | 0.2 | \$132 | \$149 |
| 30"H Frame | HRVC30PLF | HRVC30PL | 3 | 0.3 | \$151 | \$168 |
| 35"H Frame | HRVC35PLF | HRVC35PL | 3 | 0.3 | \$151 | \$168 |
| 42"H Frame | HRVC42PLF | HRVC42PL | 4 | 0.4 | \$164 | \$181 |
| 50"H Frame | HRVC50PLF | HRVC50PL | 5 | 0.5 | \$169 | \$186 |
| 57½"H Frame | HRVC57PLF | HRVC57PL | 5 | 0.5 | \$175 | \$192 |
| 65"H Frame | HRVC65PLF | HRVC65PL | 6 | 0.6 | \$180 | \$197 |
| 80"H Frame | HRVC80PLF | HRVC80PL | 6 | 0.8 | \$186 | \$203 |

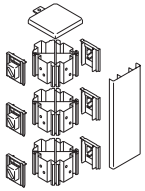

| | | | | | | |
|------------------------------------|-----------|----------|---|-----|-------|-------|
| "T" 3-Way Painted Connector | | | | | | |
| 7"H Frame | HRVC7PTF | HRVC7PT | 1 | 0.1 | \$105 | \$122 |
| 15"H Frame | HRVC15PTF | HRVC15PT | 2 | 0.1 | \$118 | \$135 |
| 22"H Frame | HRVC22PTF | HRVC22PT | 2 | 0.2 | \$132 | \$149 |
| 30"H Frame | HRVC30PTF | HRVC30PT | 3 | 0.3 | \$151 | \$168 |
| 35"H Frame | HRVC35PTF | HRVC35PT | 3 | 0.3 | \$151 | \$168 |
| 42"H Frame | HRVC42PTF | HRVC42PT | 4 | 0.4 | \$164 | \$181 |
| 50"H Frame | HRVC50PTF | HRVC50PT | 5 | 0.5 | \$169 | \$186 |
| 57½"H Frame | HRVC57PTF | HRVC57PT | 5 | 0.5 | \$175 | \$192 |
| 65"H Frame | HRVC65PTF | HRVC65PT | 6 | 0.6 | \$180 | \$197 |
| 80"H Frame | HRVC80PTF | HRVC80PT | 6 | 0.8 | \$186 | \$203 |

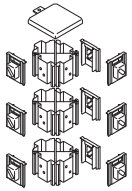

| | | | | | | |
|------------------------------------|-----------|----------|---|-----|-------|-------|
| "X" 4-Way Painted Connector | | | | | | |
| 7"H Frame | HRVC7PXF | HRVC7PX | 1 | 0.1 | \$84 | \$94 |
| 15"H Frame | HRVC15PXF | HRVC15PX | 2 | 0.1 | \$97 | \$107 |
| 22"H Frame | HRVC22PXF | HRVC22PX | 2 | 0.2 | \$106 | \$116 |
| 30"H Frame | HRVC30PXF | HRVC30PX | 3 | 0.3 | \$118 | \$128 |
| 35"H Frame | HRVC35PXF | HRVC35PX | 3 | 0.3 | \$118 | \$128 |
| 42"H Frame | HRVC42PXF | HRVC42PX | 4 | 0.4 | \$158 | \$168 |
| 50"H Frame | HRVC50PXF | HRVC50PX | 6 | 0.5 | \$164 | \$174 |
| 57½"H Frame | HRVC57PXF | HRVC57PX | 5 | 0.5 | \$166 | \$176 |
| 65"H Frame | HRVC65PXF | HRVC65PX | 7 | 0.6 | \$169 | \$179 |
| 80"H Frame | HRVC80PXF | HRVC80PX | 6 | 0.8 | \$180 | \$190 |

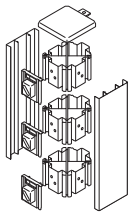

| | | | | | | |
|--|-----------|----------|---|-----|-------|-------|
| "S" Extended Straight Painted Connector | | | | | | |
| 7"H Frame | HRVC7PSF | HRVC7PS | 1 | 0.1 | \$129 | \$146 |
| 15"H Frame | HRVC15PSF | HRVC15PS | 2 | 0.1 | \$140 | \$157 |
| 22"H Frame | HRVC22PSF | HRVC22PS | 2 | 0.2 | \$152 | \$169 |
| 30"H Frame | HRVC30PSF | HRVC30PS | 3 | 0.3 | \$164 | \$181 |
| 35"H Frame | HRVC35PSF | HRVC35PS | 3 | 0.3 | \$164 | \$181 |
| 42"H Frame | HRVC42PSF | HRVC42PS | 4 | 0.4 | \$188 | \$205 |
| 50"H Frame | HRVC50PSF | HRVC50PS | 6 | 0.5 | \$197 | \$214 |
| 57½"H Frame | HRVC57PSF | HRVC57PS | 6 | 0.5 | \$202 | \$219 |
| 65"H Frame | HRVC65PSF | HRVC65PS | 7 | 0.6 | \$209 | \$226 |
| 80"H Frame | HRVC80PSF | HRVC80PS | 7 | 0.8 | \$224 | \$241 |

NOTES:

- All connectors include a light-gap strip.
- Abound connectors utilize a universal connector block designed to make one connection to the panel.
- Bracket clips come standard.
- 7"H connectors include one connector block; 15"H, 22"H, 30"H include two connector blocks; 50"H includes three connector blocks and 65"H includes four connector blocks.
- Connectors ship complete with trim.
- Outer trim snaps easily into place.
- Extended Straight Connectors are used to keep a frame run dimensionally consistent with opposing frame runs. Add 2¾" to the length of the run with each Extended Straight Connector used.

ⓘ Trim with Abound connectors can only be attached to connectors, not on panels.

HOW TO SPECIFY

| | |
|---|--|
| <p>Select Model Number</p> <p>HRVC35PL. T4</p> | <p>Select Paint Color</p> <p>See page 423</p> |
|---|--|

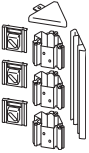
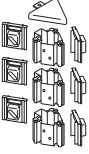

| | DESCRIPTION | FLAT MODEL | CHAMFERED MODEL | SHIP WEIGHT | CUBE | LIST PRICE BY PAINT GRADE | |
|---|--|-------------------|------------------|-------------|------|---------------------------|--------------|
| | | | | | | P1 | P2 |
|  | "Y" 120° Degree, Two-Sided, Painted Connector | | | | | | |
| | 35"H Frame | HRVC35PY2F | HRVC35PY2 | 3 | 0.3 | \$151 | \$168 |
| | 42"H Frame | HRVC42PY2F | HRVC42PY2 | 4 | 0.4 | \$164 | \$181 |
| | 50"H Frame | HRVC50PY2F | HRVC50PY2 | 5 | 0.5 | \$180 | \$197 |
| | 57½"H Frame | HRVC57PY2F | HRVC57PY2 | 5 | 0.5 | \$189 | \$206 |
| | 65"H Frame | HRVC65PY2F | HRVC65PY2 | 6 | 0.6 | \$197 | \$214 |
|  | "Y" 120° Degree, Three-Sided, Painted Connector | | | | | | |
| | 35"H Frame | HRVC35PY3F | HRVC35PY3 | 3 | 0.3 | \$132 | \$149 |
| | 42"H Frame | HRVC42PY3F | HRVC42PY3 | 4 | 0.4 | \$151 | \$168 |
| | 50"H Frame | HRVC50PY3F | HRVC50PY3 | 5 | 0.5 | \$164 | \$181 |
| | 57½"H Frame | HRVC57PY3F | HRVC57PY3 | 5 | 0.5 | \$171 | \$188 |
| | 65"H Frame | HRVC65PY3F | HRVC65PY3 | 6 | 0.6 | \$180 | \$197 |

NOTES:

- 35"H-42"H connectors include two universal connector blocks, 50"H includes three brackets and 65"H includes four brackets.
- Use Y Connectors for 120° applications.
- Abound connectors utilize a universal connector block designed to make one connection to the panel.
- Connectors ship complete with trim.
- Bracket clips come standard.
- Outer trim snaps easily into place.

HOW TO SPECIFY

| | |
|---|---|
| Select Model Number HRVC35PY2 | Select Paint Color See page 423 T3 |
|---|---|



Variable Height Finished End and Wall Starter Kits

WORKSTATIONS



| DESCRIPTION | FLAT MODEL | CHAMFERED MODEL | SHIP WEIGHT | CUBE | LIST PRICE BY PAINT GRADE | |
|---------------------|------------|-----------------|-------------|------|---------------------------|-------|
| | | | | | P1 | P2 |
| Finished End | | | | | | |
| 15"H Finished End | HRVC15PFF | HRVC15PF | 1 Ⓢ | 0.1 | \$72 | \$89 |
| 30"H Finished End | HRVC30PFF | HRVC30PF | 2 Ⓢ | 0.3 | \$86 | \$103 |
| 35"H Finished End | HRVC35PFF | HRVC35PF | 2 Ⓢ | 0.3 | \$86 | \$103 |
| 42"H Finished End | HRVC42PFF | HRVC42PF | 2 Ⓢ | 0.4 | \$97 | \$114 |
| 50"H Finished End | HRVC50PFF | HRVC50PF | 3 Ⓢ | 0.5 | \$104 | \$121 |
| 57½"H Finished End | HRVC57PFF | HRVC57PF | 3 Ⓢ | 0.5 | \$106 | \$123 |
| 65"H Finished End | HRVC65PFF | HRVC65PF | 4 Ⓢ | 0.6 | \$110 | \$127 |
| 80"H Finished End | HRVC80PFF | HRVC80PF | 4 Ⓢ | 0.8 | \$116 | \$133 |



| | | | | | | |
|---|------------|-----------|-----|-----|------|------|
| Variable Height Painted Finished End | | | | | | |
| 7" Variable Height Finished End | HRVC7PFVF | HRVC7PFV | 1 Ⓢ | 0.1 | \$72 | \$82 |
| 15" Variable Height Finished End | HRVC15PFVF | HRVC15PFV | 1 Ⓢ | 0.1 | \$72 | \$82 |
| 22" Variable Height Finished End | HRVC22PFVF | HRVC22PFV | 2 Ⓢ | 0.2 | \$86 | \$96 |
| 30" Variable Height Finished End | HRVC30PFVF | HRVC30PFV | 2 Ⓢ | 0.3 | \$86 | \$96 |



| | | | | | | |
|--|-----------|--|-----|-----|------|------|
| Variable Height Painted Finished End Over Connector | | | | | | |
| 7" Variable Height Finished End Over Connector | HRVC7PFT | | 1 Ⓢ | 0.1 | \$72 | \$82 |
| 15" Variable Height Finished End Over Connector | HRVC15PFT | | 1 Ⓢ | 0.1 | \$72 | \$82 |
| 22" Variable Height Finished End Over Connector | HRVC22PFT | | 2 Ⓢ | 0.2 | \$86 | \$96 |
| 30" Variable Height Finished End Over Connector | HRVC30PFT | | 2 Ⓢ | 0.3 | \$86 | \$96 |

NOTES: Flat Variable Height Finished End can be used for Variable Height Painted Finished End Over Connectors.



| | | | | | | |
|---|------------|-----------|---|-----|------|-------|
| Frameless Glass Variable Height Trim | | | | | | |
| 7½"H | HRVC7FFVF | HRVC7FFV | 1 | 0.1 | \$65 | \$74 |
| 15"H | HRVC15FFVF | HRVC15FFV | 1 | 0.1 | \$95 | \$104 |

Specify paint only.

! Model only used with Frameless Glass on page 463.

SPECIFYING EXAMPLE: HRVC7FFV.T1



| | | | | | | |
|-------------------------|-----------|----------|-----|-----|-------|-------|
| Wall Starter Kit | | | | | | |
| 65"H | HRVC65PWF | HRVC65PW | 5 Ⓢ | 0.6 | \$197 | \$214 |

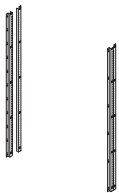

| | | | | | | |
|----------------------------------|--|-----------|-----|-----|-------|-------|
| Permanent Wall Hanger Kit | | | | | | |
| 2½"W x 7/8"D x 66"H | | HRVC35PCE | 6 Ⓢ | 0.7 | \$243 | \$263 |
| 4¼"W x 7/8"D x 66"H | | HRVC35PCM | 3 Ⓢ | 0.7 | \$128 | \$138 |

NOTES: Permanent Wall Hanger Kit can be used with both Flat and Chamfered models.

! Anchor devices are not supplied with this model. Refer to Abound® Installation instructions for appropriate hardware. Attachment to masonry walls is not recommended.

Specify paint

NOTES:

- Snaps easily onto end of frame.
 - 35"H end trim includes top cap and vertical trim.
 - 15"H and 30"H Finished End Trims do not include a top cap. These are only used for stacking frames which utilize the top trim and cap from the base frame to which they are attached.
 - 42", 50" and 65"H finished end trim includes painted top transition piece, vertical trim and carpet grippers for extra stability.
 - End trim is full-length to floor; no baserail cap is necessary.
 - Finished Ends include top cap trim. Adds 1½" to panel run.
 - Wall Starter Kit allows panel to start from a wall. Specify trim color.
 - Wall Starter adds 1½" to length of panel run.
 - Anchor devices are not supplied with the wall starter kits.
- ! Variable height trim and finished ends can only be attached to panels, not attached to connectors.

HOW TO SPECIFY

| | |
|---|---|
| <p>Select Model Number</p> <p>HRVC7PFT . T3</p> | <p>Select Paint Color</p> <p>See page 423</p> |
|---|---|



WALL HANGER BARS AND OFF-MODULE BRACKET

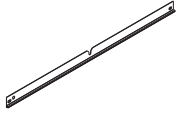

| DESCRIPTION | MODEL | SHIP WEIGHT | CUBE | LIST PRICE BY PAINT GRADE | |
|---------------------------------|------------------|-------------|------|---------------------------|-----|
| | | | | P1 | P2 |
| Wall Hanger Segment Bars | | | | | |
| 24"W | HRVFSBW24 | 2 | 0.4 | \$37 | N/A |
| 30"W | HRVFSBW30 | 2 | 0.4 | \$37 | N/A |
| 36"W | HRVFSBW36 | 3 | 0.5 | \$39 | N/A |
| 42"W | HRVFSBW42 | 3 | 0.5 | \$43 | N/A |
| 48"W | HRVFSBW48 | 3 | 0.6 | \$47 | N/A |
| 60"W | HRVFSBW60 | 4 | 0.7 | \$51 | N/A |

ⓘ Includes two tile bars. Top bar may only be used in the top uppermost position on Wall Track. Bottom bar can be used in the bottom position at any point on the wall hangers. When segmenting tiles on Wall Hangers, standard Segment Bars (page 448) must be ordered for placement between each tile reveal or at the top position of a single tile that is not in the uppermost position.

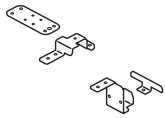

| | | | | | |
|-------------------------------|----------------|---|-----|-------------|--------------|
| Off-Module Bracket Kit | HRVOMOD | 2 | 0.1 | \$97 | \$107 |
|-------------------------------|----------------|---|-----|-------------|--------------|

- Includes top and bottom attachment brackets and top trim finished end.
- Installation requires defacing of the top tile.

ⓘ Cannot be mounted in locations where the bottom bracket covers electrical cutouts in the base pathway on parent run panels.

HOW TO SPECIFY

Select Model Number

HRVFSBW24

ABOUND[®] Tackable Acoustical Tiles

GSA SIN 33721



Icon Legend on page 19

WORKSTATIONS

| DESCRIPTION | MODEL | SHIP WEIGHT | CUBE | LIST PRICE BY FABRIC GRADE | | | | | | | |
|---|-----------|-------------|------|----------------------------|-------|-------|-------|-------|-------|-------|-------|
| | | | | AA | A | B | C | D | E | F | G |
| 7½" H Tackable Acoustical Fabric Tiles | | | | | | | | | | | |
| 7½" H x 24" W | HRVT0724T | 2 ② | 0.4 | \$70 | \$74 | \$77 | \$79 | \$85 | \$90 | \$95 | \$98 |
| 7½" H x 30" W | HRVT0730T | 2 ② | 0.5 | \$82 | \$86 | \$89 | \$93 | \$99 | \$106 | \$109 | \$112 |
| 7½" H x 36" W | HRVT0736T | 2 ② | 0.6 | \$88 | \$92 | \$95 | \$99 | \$105 | \$112 | \$115 | \$118 |
| 7½" H x 42" W | HRVT0742T | 2 ② | 0.7 | \$97 | \$102 | \$106 | \$110 | \$120 | \$123 | \$127 | \$131 |
| 7½" H x 48" W | HRVT0748T | 2 ② | 0.8 | \$103 | \$108 | \$112 | \$116 | \$126 | \$129 | \$133 | \$137 |
| 7½" H x 60" W | HRVT0760T | 3 ② | 1.0 | \$123 | \$143 | \$147 | \$152 | \$164 | \$168 | \$171 | \$174 |
| 15" H Tackable Acoustical Fabric Tiles | | | | | | | | | | | |
| 15" H x 24" W | HRVT1524T | 2 ② | 0.8 | \$73 | \$82 | \$90 | \$98 | \$114 | \$132 | \$148 | \$156 |
| 15" H x 30" W | HRVT1530T | 2 ② | 0.9 | \$74 | \$85 | \$95 | \$105 | \$127 | \$148 | \$159 | \$169 |
| 15" H x 36" W | HRVT1536T | 2 ② | 1.1 | \$81 | \$92 | \$102 | \$112 | \$134 | \$155 | \$166 | \$176 |
| 15" H x 42" W | HRVT1542T | 2 ② | 1.3 | \$83 | \$96 | \$108 | \$123 | \$156 | \$167 | \$177 | \$188 |
| 15" H x 48" W | HRVT1548T | 2 ② | 1.5 | \$91 | \$104 | \$116 | \$131 | \$164 | \$175 | \$185 | \$196 |
| 15" H x 60" W | HRVT1560T | 3 ② | 1.8 | \$104 | \$117 | \$129 | \$144 | \$177 | \$188 | \$198 | \$209 |
| 22½" H Tackable Acoustical Tiles | | | | | | | | | | | |
| 22½" H x 24" W | HRVT2224T | 2 | 1.1 | \$83 | \$93 | \$102 | \$112 | \$131 | \$153 | \$167 | \$176 |
| 22½" H x 30" W | HRVT2230T | 2 | 1.4 | \$86 | \$98 | \$109 | \$122 | \$145 | \$173 | \$200 | \$210 |
| 22½" H x 36" W | HRVT2236T | 2 | 1.6 | \$95 | \$110 | \$123 | \$134 | \$171 | \$201 | \$212 | \$222 |
| 22½" H x 42" W | HRVT2242T | 2 | 1.9 | \$102 | \$117 | \$130 | \$144 | \$187 | \$211 | \$222 | \$233 |
| 22½" H x 48" W | HRVT2248T | 2 | 2.2 | \$109 | \$124 | \$137 | \$151 | \$194 | \$218 | \$229 | \$240 |
| 22½" H x 60" W | HRVT2260T | 3 | 2.6 | \$126 | \$141 | \$154 | \$168 | \$211 | \$235 | \$246 | \$257 |
| 30" H Tackable Acoustical Tiles | | | | | | | | | | | |
| 30" H x 24" W | HRVT3024T | 2 ② | 1.4 | \$99 | \$110 | \$120 | \$131 | \$153 | \$180 | \$191 | \$201 |
| 30" H x 30" W | HRVT3030T | 2 ② | 1.8 | \$103 | \$116 | \$128 | \$143 | \$168 | \$202 | \$246 | \$256 |
| 30" H x 36" W | HRVT3036T | 2 ② | 2.1 | \$111 | \$129 | \$145 | \$157 | \$210 | \$248 | \$259 | \$269 |
| 30" H x 42" W | HRVT3042T | 3 ② | 2.4 | \$126 | \$142 | \$157 | \$169 | \$223 | \$260 | \$272 | \$282 |
| 30" H x 48" W | HRVT3048T | 3 ② | 2.8 | \$134 | \$150 | \$165 | \$177 | \$231 | \$268 | \$280 | \$290 |
| 30" H x 60" W | HRVT3060T | 4 ② | 3.4 | \$151 | \$167 | \$182 | \$194 | \$248 | \$285 | \$297 | \$307 |
| 37" H Tackable Acoustical Tiles | | | | | | | | | | | |
| 37" H x 24" W | HRVT3724T | 2 ② | 2.0 | \$113 | \$129 | \$144 | \$162 | \$215 | \$247 | \$259 | \$269 |
| 37" H x 30" W | HRVT3730T | 3 ② | 2.4 | \$129 | \$145 | \$160 | \$178 | \$231 | \$263 | \$275 | \$285 |
| 37" H x 36" W | HRVT3736T | 4 ② | 2.9 | \$147 | \$166 | \$185 | \$206 | \$270 | \$317 | \$328 | \$339 |
| 37" H x 42" W | HRVT3742T | 4 ② | 3.4 | \$164 | \$185 | \$205 | \$229 | \$310 | \$358 | \$368 | \$379 |
| 37" H x 48" W | HRVT3748T | 5 ② | 3.8 | \$172 | \$193 | \$215 | \$238 | \$321 | \$370 | \$382 | \$393 |
| 37" H x 60" W | HRVT3760T | 6 | 4.6 | \$197 | \$223 | \$249 | \$280 | \$362 | \$422 | \$433 | \$445 |

① Segment bars ordered separately. See page 448.

NOTES:

- Tiles attach directly onto the panels. No additional hardware is needed.
- Tiles are non-dedicated.
- For monolithic applications, subtract 5" from the frame height to determine monolithic tile height.
- ④ Fabric tiles have a Class A fire rating.
- ① Tiles do not include segment bars, must be ordered separately. See page 448. Not needed on monolithic tiles.
- ① One segment bar required per panel reveal, per panel side.

HOW TO SPECIFY

| | |
|----------------------------|----------------------------|
| Select Model Number | Select Fabric Color |
| | See pages 424-425 |
| HRVT1524T | APN11 |



ABOUND® Tackable Acoustical Tiles

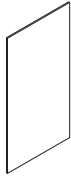

| DESCRIPTION | MODEL | SHIP WEIGHT | CUBE | LIST PRICE BY FABRIC GRADE | | | | | | | | |
|--|-----------|-------------|------|----------------------------|-------|-------|-------|-------|-------|-------|-------|--|
| | | | | AA | A | B | C | D | E | F | G | |
| 45" H Tackable Acoustical Tiles | | | | | | | | | | | | |
| 45" H x 24" W | HRVT4524T | 2 | 2.3 | \$125 | \$144 | \$164 | \$185 | \$251 | \$299 | \$310 | \$322 | |
| 45" H x 30" W | HRVT4530T | 3 | 2.9 | \$141 | \$162 | \$182 | \$207 | \$290 | \$338 | \$350 | \$362 | |
| 45" H x 36" W | HRVT4536T | 5 | 3.4 | \$168 | \$189 | \$211 | \$234 | \$317 | \$366 | \$378 | \$389 | |
| 45" H x 42" W | HRVT4542T | 5 | 4.0 | \$197 | \$218 | \$238 | \$263 | \$345 | \$394 | \$406 | \$418 | |
| 45" H x 48" W | HRVT4548T | 6 | 4.5 | \$222 | \$243 | \$271 | \$288 | \$371 | \$420 | \$432 | \$443 | |
| 45" H x 60" W | HRVT4560T | 7 | 5.6 | \$242 | \$268 | \$295 | \$326 | \$407 | \$467 | \$479 | \$491 | |



| | | | | | | | | | | | | |
|--|-----------|---|-----|-------|-------|-------|-------|-------|-------|-------|-------|--|
| 52 1/2" H Tackable Acoustical Tiles | | | | | | | | | | | | |
| 52 1/2" H x 24" W | HRVT5224T | 2 | 2.6 | \$138 | \$166 | \$196 | \$227 | \$309 | \$362 | \$374 | \$408 | |
| 52 1/2" H x 30" W | HRVT5230T | 3 | 3.2 | \$157 | \$189 | \$223 | \$257 | \$347 | \$407 | \$420 | \$471 | |
| 52 1/2" H x 36" W | HRVT5236T | 4 | 3.8 | \$185 | \$217 | \$251 | \$283 | \$374 | \$435 | \$448 | \$499 | |
| 52 1/2" H x 42" W | HRVT5242T | 5 | 4.4 | \$205 | \$241 | \$279 | \$312 | \$415 | \$476 | \$488 | \$560 | |
| 52 1/2" H x 48" W | HRVT5248T | 6 | 4.9 | \$231 | \$267 | \$307 | \$338 | \$441 | \$535 | \$548 | \$619 | |
| 52 1/2" H x 60" W | HRVT5260T | 7 | 6.1 | \$249 | \$291 | \$334 | \$368 | \$500 | \$576 | \$588 | \$659 | |

Segment bars ordered separately. See page 448.



| | | | | | | | | | | | | |
|--|-----------|---|-----|-------|-------|-------|-------|-------|-------|-------|-------|--|
| 60" H Tackable Acoustical Tiles | | | | | | | | | | | | |
| 60" H x 24" W | HRVT6024T | 3 | 3.0 | \$147 | \$178 | \$211 | \$245 | \$333 | \$387 | \$400 | \$441 | |
| 60" H x 30" W | HRVT6030T | 4 | 3.7 | \$166 | \$202 | \$240 | \$277 | \$369 | \$434 | \$447 | \$511 | |
| 60" H x 36" W | HRVT6036T | 6 | 4.4 | \$193 | \$229 | \$267 | \$302 | \$395 | \$460 | \$474 | \$538 | |
| 60" H x 42" W | HRVT6042T | 6 | 5.1 | \$209 | \$250 | \$294 | \$330 | \$439 | \$504 | \$517 | \$608 | |
| 60" H x 48" W | HRVT6048T | 7 | 5.8 | \$237 | \$278 | \$322 | \$358 | \$467 | \$576 | \$590 | \$680 | |
| 60" H x 60" W | HRVT6060T | 9 | 7.2 | \$252 | \$299 | \$347 | \$383 | \$531 | \$613 | \$625 | \$716 | |

Segment bars ordered separately. See page 448.

NOTES:

- Tiles are non-dedicated.
- Tiles attach directly onto the panels. No additional hardware is needed.
- For monolithic applications, subtract 5" from the frame height to determine monolithic tile height.
- Fabric tiles have a Class A fire rating.
- Tiles do not include segment bars, must be ordered separately. See page 448. Not needed on monolithic tiles.
- One segment bar required per panel reveal, per panel side.

HOW TO SPECIFY

| | |
|---|--|
| <p>Select Model Number</p> <p>HRVT4524T</p> | <p>Select Fabric Color</p> <p>See pages 424-425</p> <p>APN11</p> |
|---|--|

ABOUND[®] Power/Data Fabric Tiles

GSA SIN 33721



Icon Legend on page 19

WORKSTATIONS



| DESCRIPTION | MODEL | SHIP WEIGHT | CUBE | LIST PRICE BY FABRIC GRADE | | | | | | | | | |
|--------------------------------------|-----------|-------------|------|----------------------------|-------|-------|-------|-------|-------|-------|-------|--|--|
| | | | | AA | A | B | C | D | E | F | G | | |
| 15''H Power/Data Fabric Tiles | | | | | | | | | | | | | |
| 15''H x 24''W | HRVT1524E | 2 | 0.8 | \$144 | \$153 | \$161 | \$169 | \$185 | \$203 | \$219 | \$227 | | |
| 15''H x 30''W | HRVT1530E | 2 | 0.9 | \$145 | \$156 | \$166 | \$176 | \$198 | \$219 | \$230 | \$240 | | |
| 15''H x 36''W | HRVT1536E | 2 | 1.1 | \$153 | \$164 | \$174 | \$184 | \$206 | \$227 | \$238 | \$248 | | |
| 15''H x 42''W | HRVT1542E | 2 | 1.3 | \$155 | \$168 | \$180 | \$195 | \$228 | \$239 | \$249 | \$260 | | |
| 15''H x 48''W | HRVT1548E | 2 | 1.5 | \$162 | \$175 | \$187 | \$202 | \$235 | \$246 | \$256 | \$267 | | |
| 15''H x 60''W | HRVT1560E | 3 | 1.8 | \$175 | \$188 | \$200 | \$215 | \$248 | \$259 | \$269 | \$280 | | |

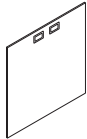

| | | | | | | | | | | | | | |
|--------------------------------------|-----------|---|-----|-------|-------|-------|-------|-------|-------|-------|-------|--|--|
| 30''H Power/Data Fabric Tiles | | | | | | | | | | | | | |
| 30''H x 24''W | HRVT3024E | 2 | 1.4 | \$168 | \$179 | \$189 | \$200 | \$222 | \$249 | \$260 | \$270 | | |
| 30''H x 30''W | HRVT3030E | 2 | 1.8 | \$173 | \$186 | \$198 | \$213 | \$238 | \$272 | \$316 | \$326 | | |
| 30''H x 36''W | HRVT3036E | 2 | 2.1 | \$184 | \$202 | \$218 | \$230 | \$283 | \$321 | \$332 | \$342 | | |
| 30''H x 42''W | HRVT3042E | 3 | 2.4 | \$201 | \$217 | \$232 | \$244 | \$298 | \$335 | \$347 | \$357 | | |
| 30''H x 48''W | HRVT3048E | 3 | 2.8 | \$207 | \$223 | \$238 | \$250 | \$304 | \$341 | \$353 | \$363 | | |
| 30''H x 60''W | HRVT3060E | 4 | 3.4 | \$222 | \$238 | \$253 | \$265 | \$319 | \$356 | \$368 | \$378 | | |

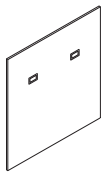

| | | | | | | | | | | | | | |
|--------------------------------------|-----------|---|-----|-------|-------|-------|-------|-------|-------|-------|-------|--|--|
| 37''H Power/Data Fabric Tiles | | | | | | | | | | | | | |
| 37''H x 24''W | HRVT3724E | 2 | 2.0 | \$186 | \$202 | \$217 | \$235 | \$288 | \$320 | \$332 | \$342 | | |
| 37''H x 30''W | HRVT3730E | 3 | 2.4 | \$203 | \$219 | \$234 | \$252 | \$305 | \$337 | \$349 | \$359 | | |
| 37''H x 36''W | HRVT3736E | 4 | 2.9 | \$215 | \$234 | \$253 | \$274 | \$338 | \$385 | \$396 | \$407 | | |
| 37''H x 42''W | HRVT3742E | 4 | 3.4 | \$229 | \$250 | \$270 | \$294 | \$375 | \$423 | \$433 | \$444 | | |
| 37''H x 48''W | HRVT3748E | 5 | 3.8 | \$246 | \$267 | \$289 | \$312 | \$395 | \$444 | \$456 | \$467 | | |
| 37''H x 60''W | HRVT3760E | 6 | 4.7 | \$271 | \$297 | \$323 | \$354 | \$436 | \$496 | \$507 | \$519 | | |

Segment bars ordered separately. See page 448.

NOTES:

- Power/Data tiles are tackable and acoustical.
- Tiles attach directly onto the panels. No additional hardware is needed.
- Tiles are non-dedicated.
- 24''W tiles have one port. Other widths have two.
- Power/Data grommet opening is 2¹/₈''W x 1³/₈''H. With glides retracted grommets are 30'' from the floor and 10¹/₂'' from the edge of the frame.
- Power/Data ports are factory installed.

Fabric tiles have a Class A fire rating.

Ports on all tile sizes are located above the worksurface. Tiles cannot be flipped to change port location.

Tiles do not include segment bars, must be ordered separately. See page 448. Can be used in any combination.

One segment bar required per panel reveal, per panel side.

Electrical mounting brackets must be ordered separately. See page 613.

HOW TO SPECIFY

| | | |
|---|--|---|
| <p>Select Model Number</p> <p>HRVT1524E</p> | <p>Select Fabric Color</p> <p>See pages 424-425</p> <p>APN11</p> | <p>Select Electrical Power/Data Grommet Color</p> <p>See page 423</p> <p>T5</p> |
|---|--|---|



ABOUND® Power/Data Fabric Tiles

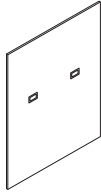

| DESCRIPTION | MODEL | SHIP WEIGHT | CUBE | LIST PRICE BY FABRIC GRADE | | | | | | | | |
|-------------------------------------|------------------|-------------|------|----------------------------|-------|-------|-------|-------|-------|-------|-------|--|
| | | | | AA | A | B | C | D | E | F | G | |
| 45"H Power/Data Fabric Tiles | | | | | | | | | | | | |
| 45"H x 24"W | HRVT4524E | 2 | 2.3 | \$200 | \$219 | \$239 | \$260 | \$326 | \$374 | \$385 | \$397 | |
| 45"H x 30"W | HRVT4530E | 3 | 2.9 | \$215 | \$236 | \$256 | \$281 | \$364 | \$412 | \$424 | \$436 | |
| 45"H x 36"W | HRVT4536E | 5 | 3.4 | \$244 | \$265 | \$287 | \$310 | \$393 | \$442 | \$454 | \$465 | |
| 45"H x 42"W | HRVT4542E | 5 | 4.0 | \$271 | \$292 | \$312 | \$337 | \$419 | \$468 | \$480 | \$492 | |
| 45"H x 48"W | HRVT4548E | 6 | 4.5 | \$298 | \$319 | \$347 | \$364 | \$447 | \$496 | \$508 | \$519 | |
| 45"H x 60"W | HRVT4560E | 7 | 5.6 | \$318 | \$344 | \$371 | \$402 | \$483 | \$543 | \$555 | \$567 | |

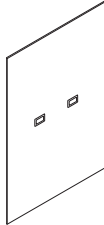

| | | | | | | | | | | | | |
|--------------------------------------|------------------|---|-----|-------|-------|-------|-------|-------|-------|-------|-------|--|
| 52½"H Power/Data Fabric Tiles | | | | | | | | | | | | |
| 52½"H x 24"W | HRVT5224E | 2 | 2.8 | \$212 | \$242 | \$272 | \$302 | \$385 | \$432 | \$450 | \$484 | |
| 52½"H x 30"W | HRVT5230E | 3 | 3.4 | \$232 | \$267 | \$301 | \$335 | \$424 | \$483 | \$498 | \$549 | |
| 52½"H x 36"W | HRVT5236E | 4 | 4.0 | \$259 | \$293 | \$327 | \$359 | \$450 | \$511 | \$524 | \$575 | |
| 52½"H x 42"W | HRVT5242E | 5 | 4.6 | \$279 | \$317 | \$355 | \$388 | \$490 | \$551 | \$564 | \$635 | |
| 52½"H x 48"W | HRVT5248E | 6 | 5.1 | \$307 | \$345 | \$385 | \$416 | \$519 | \$613 | \$626 | \$696 | |
| 52½"H x 60"W | HRVT5260E | 7 | 6.3 | \$325 | \$368 | \$411 | \$445 | \$577 | \$653 | \$665 | \$736 | |

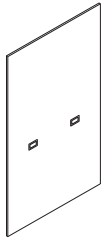

| | | | | | | | | | | | | |
|-------------------------------------|------------------|---|-----|-------|-------|-------|-------|-------|-------|-------|-------|--|
| 60"H Power/Data Fabric Tiles | | | | | | | | | | | | |
| 60"H x 24"W | HRVT6024E | 3 | 3.0 | \$219 | \$250 | \$283 | \$317 | \$405 | \$459 | \$472 | \$513 | |
| 60"H x 30"W | HRVT6030E | 4 | 3.7 | \$242 | \$278 | \$316 | \$353 | \$445 | \$510 | \$523 | \$587 | |
| 60"H x 36"W | HRVT6036E | 6 | 4.4 | \$268 | \$304 | \$342 | \$377 | \$470 | \$535 | \$549 | \$613 | |
| 60"H x 42"W | HRVT6042E | 6 | 5.1 | \$285 | \$326 | \$370 | \$406 | \$515 | \$580 | \$593 | \$684 | |
| 60"H x 48"W | HRVT6048E | 7 | 5.8 | \$312 | \$353 | \$397 | \$433 | \$542 | \$651 | \$665 | \$755 | |
| 60"H x 60"W | HRVT6060E | 9 | 7.2 | \$328 | \$375 | \$423 | \$459 | \$607 | \$689 | \$701 | \$792 | |

Segment bars ordered separately. See page 448.

NOTES:

- Tiles are non-dedicated.
- Tiles attach directly onto the panels. No additional hardware is needed.
- 24"W tiles have one port. Other widths have two.
- Power/Data grommet opening is 2 1/16"W x 1 1/8"H. With glides retracted grommet are 30" from the floor and 10 1/2" from the edge of the frame.
- Power/Data ports are factory installed.
- Fabric tiles have a Class A fire rating.
- Ports on all tile sizes are located above the worksurface. Tiles cannot be flipped to change port location.
- Tiles do not include segment bars, must be ordered separately. See page 448. Can be used in any combination.
- One segment bar required per panel reveal, per panel side.
- Electrical mounting brackets must be ordered separately. See page 613.

HOW TO SPECIFY

| | | |
|--|---|--|
| <p>Select Model Number</p> <p>HRVT4524E</p> | <p>Select Fabric Color</p> <p>See pages 424-425</p> <p>APN11</p> | <p>Select Electrical Power/Data Grommet Color</p> <p>See page 423</p> <p>T5</p> |
|--|---|--|

ABOUND® Hard-surface Tiles

GSA SIN 33721



Icon Legend on page 19

WORKSTATIONS

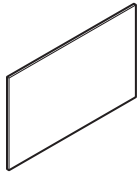

DESCRIPTION

15" Hard-surface Tile and Mounting Kit

15"H x 24"W
15"H x 30"W
15"H x 36"W
15"H x 42"W
15"H x 48"W
15"H x 60"W

MODEL

HRVT1524HS2
HRVT1530HS2
HRVT1536HS2
HRVT1542HS2
HRVT1548HS2
HRVT1560HS2

SHIP WEIGHT CUBE

11 0.8
13 0.9
15 1.1
17 1.3
21 1.5
25 1.8

LIST PRICE BY LAMINATE GRADE

L1 L2

\$239 **\$249**
\$251 **\$261**
\$269 **\$279**
\$285 **\$295**
\$298 **\$313**
\$338 **\$353**

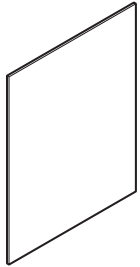

30" Hard-surface Tile and Mounting Kit

30"H x 24"W
30"H x 30"W
30"H x 36"W
30"H x 42"W
30"H x 48"W
30"H x 60"W

HRVT3024HS2
HRVT3030HS2
HRVT3036HS2
HRVT3042HS2
HRVT3048HS2
HRVT3060HS2

17 1.4
19 1.8
21 2.1
24 2.4
28 2.8
30 3.4

\$292 **\$307**
\$314 **\$329**
\$349 **\$364**
\$381 **\$396**
\$402 **\$422**
\$441 **\$461**

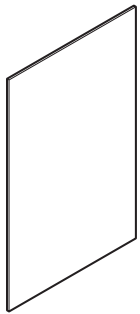

37" Hard-surface Tile and Mounting Kit

37"H x 24"W
37"H x 30"W
37"H x 36"W
37"H x 42"W
37"H x 48"W
37"H x 60"W

HRVT3724HS2
HRVT3730HS2
HRVT3736HS2
HRVT3742HS2
HRVT3748HS2
HRVT3760HS2

17 1.4
17 1.8
19 2.1
21 2.4
24 2.8
30 3.4

\$356 **\$376**
\$392 **\$412**
\$430 **\$450**
\$473 **\$493**
\$511 **\$536**
\$578 **\$603**

NOTES:

- Tiles are made from high-pressure laminate.
- Available in all standard HON laminates.
- On woodgrain laminates, grain direction is vertical.
- Specify paint color.
- 15"H and 30"H tiles are non-dedicated and can be used in any tile position (except on 42"H frames.)

- ❗ All tiles ship with Custom Bracket Kit installed on the tile.
- ❗ One segment bar is required per panel reveal, per panel side.
- ❗ Tiles do not ship with segment bars — must be ordered separately. See page 448. Segment bars are not needed for 42"H monolithic tiles.

HOW TO SPECIFY

| | | |
|---|---|---|
| <p>Select Model Number</p> <p>HRVT1524HS2</p> | <p>Select Laminate Color</p> <p>See page 423</p> <p>H</p> | <p>Select Paint Color</p> <p>See page 423</p> <p>T1</p> |
|---|---|---|

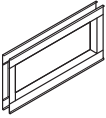
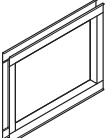

ABOUND® Clear Glass Tiles

| | DESCRIPTION | MODEL | SHIP WEIGHT | CUBE | LIST PRICE BY PAINT GRADE | |
|---|-------------------------------|------------------|-------------|------|---------------------------|---------------|
| | | | | | P1 | P2 |
|  | 15”H Clear Glass Tiles | | | | | |
| | 15”H x 24”W | HRVT1524G | 12 | 0.8 | \$515 | \$534 |
| | 15”H x 30”W | HRVT1530G | 15 | 0.9 | \$545 | \$564 |
| | 15”H x 36”W | HRVT1536G | 17 | 1.1 | \$576 | \$595 |
| | 15”H x 42”W | HRVT1542G | 19 | 1.3 | \$615 | \$635 |
| | 15”H x 48”W | HRVT1548G | 20 | 1.5 | \$661 | \$681 |
| | 15”H x 60”W | HRVT1560G | 26 | 1.8 | \$790 | \$810 |
|  | 30”H Clear Glass Tiles | | | | | |
| | 30”H x 24”W | HRVT3024G | 15 | 1.4 | \$684 | \$704 |
| | 30”H x 30”W | HRVT3030G | 21 | 1.8 | \$730 | \$750 |
| | 30”H x 36”W | HRVT3036G | 22 | 2.1 | \$777 | \$797 |
| | 30”H x 42”W | HRVT3042G | 25 | 2.4 | \$840 | \$860 |
| | 30”H x 48”W | HRVT3048G | 28 | 2.9 | \$904 | \$924 |
| | 30”H x 60”W | HRVT3060G | 33 | 3.4 | \$1059 | \$1079 |

! Segment bars ordered separately. See page 448.

NOTES:

- Glass is off-set and may be placed on either side of the frame.
- Tile is a single-pane, tempered glass.
- For worksurfaces that can be used with both Abound® and Accelerate® systems, see pages 617-629.
- ! Glass tiles have a Class A fire rating.
- ! Tiles do not include segment bars, must be ordered separately. See page 448. Can be used in any combination.
- ! Glass tiles cannot be placed in the second tier (20”-35” range) due to interference with the horizontal support. Glass tiles cannot be placed in the bottom tier of a frame.
- ! Glass tiles will not work with 42”H frames — use stackers with glass on 42½”H panels.
- ! When stacking on 42½”H frames, panel slots will be off by ½” compared to any other height panel.

HOW TO SPECIFY

| | |
|--|--|
| <p>Select Model Number</p> <p>HRVT1524G</p> | <p>Select Interior Shroud Paint Color</p> <p>See page 423. Available in all P1/P2 paint colors.</p> <p>T1</p> |
|--|--|

ABOUND® Frosted Glass Tiles

GSA SIN 33721



Icon Legend on page 19

WORKSTATIONS

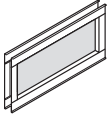

DESCRIPTION

15”H Frosted Glass Tiles

15”H x 24”W
15”H x 30”W
15”H x 36”W
15”H x 42”W
15”H x 48”W
15”H x 60”W

MODEL

SHIP WEIGHT

CUBE

LIST PRICE BY PAINT GRADE

P1

P2

| | | | | |
|------------------|----|-----|--------------|---------------|
| HRVT1524R | 12 | 0.8 | \$633 | \$652 |
| HRVT1530R | 15 | 0.9 | \$680 | \$699 |
| HRVT1536R | 17 | 1.1 | \$726 | \$745 |
| HRVT1542R | 19 | 1.3 | \$777 | \$797 |
| HRVT1548R | 20 | 1.5 | \$838 | \$858 |
| HRVT1560R | 26 | 1.8 | \$980 | \$1000 |

30”H Frosted Glass Tiles

30”H x 24”W
30”H x 30”W
30”H x 36”W
30”H x 42”W
30”H x 48”W
30”H x 60”W

| | | | | |
|------------------|----|-----|---------------|---------------|
| HRVT3024R | 15 | 1.4 | \$894 | \$914 |
| HRVT3030R | 21 | 1.8 | \$954 | \$974 |
| HRVT3036R | 22 | 2.1 | \$1018 | \$1038 |
| HRVT3042R | 25 | 2.4 | \$1095 | \$1115 |
| HRVT3048R | 28 | 2.9 | \$1172 | \$1192 |
| HRVT3060R | 33 | 3.4 | \$1345 | \$1365 |

! Segment bars ordered separately. See page 448.

NOTES:

- Glass is off-set and may be placed on either side of the frame.
- Tile is a single-pane, tempered glass.
- For worksurfaces that can be used with both Abound® and Accelerate® systems, see pages 617-629.
- ! Glass tiles have a Class A fire rating.
- ! Tiles do not include segment bars, must be ordered separately. See page 448. Can be used in any combination.
- ! Glass tiles cannot be placed in the second tier (20”-35” range) due to interference with the horizontal support. Glass tiles cannot be placed in the bottom tier of a frame.
- ! Glass tiles will not work with 42”H frames — use stackers with glass on 42½”H panels.
- ! When stacking on 42½”H frames, panel slots will be off by ½” compared to any other height panel.

HOW TO SPECIFY

Select
Model Number

Select
Interior Shroud Paint Color

See page 423. Available in all P1/P2 paint colors.

HRVT1524R . T1



Icon Legend on page 19

ABOUND® Frameless Glass

WORKSTATIONS

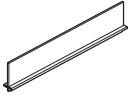

DESCRIPTION

7 1/2" H Frameless Glass

| |
|---|
| 7 1/2" H x 24" W |
| 7 1/2" H x 30" W |
| 7 1/2" H x 36" W |
| 7 1/2" H x 42" W |
| 7 1/2" H x 48" W |
| 7 1/2" H x 54" W (24" + 30") |
| 7 1/2" H x 60" W |
| 7 1/2" H x 66" W (30" + 36") |
| 7 1/2" H x 72" W (36" + 36") |
| 7 1/2" H x 78" W (48" + 30") |
| 7 1/2" H x 84" W (36" + 48" or 42" + 42") |
| 7 1/2" H x 90" W (42" + 48") |
| 7 1/2" H x 96" W (48" + 48" or 36" + 60") |

| FLAT MODEL | CHAMFERED MODEL | SHIP WEIGHT | CUBE | CLEAR GLASS | FROSTED GLASS |
|------------|-----------------|-------------|------|-------------|---------------|
| HRVT0724FF | HRVT0724F | 18 | 0.5 | \$457 | \$492 |
| HRVT0730FF | HRVT0730F | 18 | 0.5 | \$489 | \$526 |
| HRVT0736FF | HRVT0736F | 21 | 0.6 | \$568 | \$611 |
| HRVT0742FF | HRVT0742F | 25 | 0.7 | \$598 | \$644 |
| HRVT0748FF | HRVT0748F | 28 | 0.8 | \$640 | \$690 |
| HRVT0754FF | HRVT0754F | 28 | 0.8 | \$711 | \$765 |
| HRVT0760FF | HRVT0760F | 35 | 1.0 | \$781 | \$842 |
| HRVT0766FF | HRVT0766F | 35 | 1.0 | \$856 | \$922 |
| HRVT0772FF | HRVT0772F | 42 | 1.9 | \$929 | \$1001 |
| HRVT0778FF | HRVT0778F | 42 | 1.9 | \$998 | \$1075 |
| HRVT0784FF | HRVT0784F | 50 | 2.1 | \$1065 | \$1148 |
| HRVT0790FF | HRVT0790F | 50 | 2.1 | \$1139 | \$1226 |
| HRVT0796FF | HRVT0796F | 57 | 2.4 | \$1205 | \$1297 |

NOTES: For models 54"W-96"W, glass can span multiple panel widths. See examples of panel sizes by glass width above.

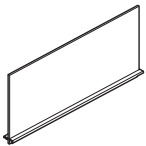

15" H Frameless Glass

| |
|--|
| 15" H x 24" W |
| 15" H x 30" W |
| 15" H x 36" W |
| 15" H x 42" W |
| 15" H x 48" W |
| 15" H x 54" W (24" + 30") |
| 15" H x 60" W |
| 15" H x 66" W (30" + 36") |
| 15" H x 72" W (36" + 36") |
| 15" H x 78" W (48" + 30") |
| 15" H x 84" W (36" + 48" or 42" + 42") |
| 15" H x 90" W (42" + 48") |
| 15" H x 96" W (48" + 48" or 36" + 60") |

| | | | | | |
|------------|-----------|----|-----|--------|--------|
| HRVT1524FF | HRVT1524F | 28 | 1.5 | \$514 | \$551 |
| HRVT1530FF | HRVT1530F | 28 | 1.5 | \$546 | \$587 |
| HRVT1536FF | HRVT1536F | 34 | 1.8 | \$633 | \$680 |
| HRVT1542FF | HRVT1542F | 39 | 2.0 | \$674 | \$724 |
| HRVT1548FF | HRVT1548F | 45 | 2.3 | \$720 | \$774 |
| HRVT1554FF | HRVT1554F | 51 | 2.6 | \$798 | \$859 |
| HRVT1560FF | HRVT1560F | 57 | 2.8 | \$877 | \$943 |
| HRVT1566FF | HRVT1566F | 62 | 3.2 | \$960 | \$1032 |
| HRVT1572FF | HRVT1572F | 67 | 3.5 | \$1041 | \$1119 |
| HRVT1578FF | HRVT1578F | 63 | 3.7 | \$1185 | \$1273 |
| HRVT1584FF | HRVT1584F | 78 | 3.9 | \$1323 | \$1422 |
| HRVT1590FF | HRVT1590F | 74 | 4.2 | \$1363 | \$1465 |
| HRVT1596FF | HRVT1596F | 89 | 4.4 | \$1401 | \$1507 |

NOTES: For models 54"W-96"W, glass can span multiple panel widths. See suggested panel sizes by glass width above.

NOTES:

- Tile is a single-pane, 3/8" laminated safety glass.
- Available in clear or frosted glass.
- New top cap ships with Frameless Glass which fits around the glass insert.
- Frameless Glass can span multiple panels with one piece of glass.
- Lamination is in the center of the glass, making both clear and frosted glass a writable surface with dry-erase markers.
- ⚠ Glass tiles have a Class A fire rating.
- ⚠ Frameless Glass can only be used on the top of panels. Glass integrates into top cap trim.
- ⚠ Power and data cords cannot lay in the top of panel frames when using frameless glass.
- ⚠ Variable height trim for Frameless Glass must be ordered when using panel heights one step up; see page 454.
- ⚠ Cannot hang or stack on top of Frameless Glass.
- ⚠ Abound® power pole cannot be used with Frameless Glass. Freestanding power pole HH870070 can be used at the end of run or one panel needs to be specified without Frameless Glass for ceiling in-feed to enter the panel.

HOW TO SPECIFY

| | | |
|--|---|--|
| <p>Select Model Number</p> <p>HRVT0724F</p> | <p>Select Glass Option</p> <p>G Clear R Frosted</p> <p>G</p> | <p>Select Paint Color</p> <p>See page 423 P1 Paint (no upcharge) P2 Paint (\$17 upcharge)</p> <p>T1</p> |
|--|---|--|

ABOUND[®] Pass-thru Tiles

GSA SIN 33721



Icon Legend on page 19

WORKSTATIONS

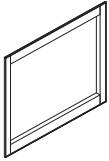

| DESCRIPTION | MODEL | SHIP WEIGHT | CUBE | LIST PRICE BY PAINT GRADE | |
|---------------------------------|------------------|-------------|------|---------------------------|--------------|
| | | | | P1 | P2 |
| 30" H Pass-Thru Tile Kit | | | | | |
| 22½" H x 24" W | HRVT3024P | 8 | 1.2 | \$143 | \$163 |
| 22½" H x 30" W | HRVT3030P | 8 | 1.5 | \$163 | \$183 |
| 22½" H x 36" W | HRVT3036P | 9 | 1.8 | \$180 | \$200 |
| 22½" H x 42" W | HRVT3042P | 10 | 2.1 | \$187 | \$207 |
| 22½" H x 48" W | HRVT3048P | 11 | 2.3 | \$207 | \$227 |
| 22½" H x 60" W | HRVT3060P | 12 | 2.9 | \$215 | \$235 |

NOTES: Pass-thru opening is 22½" H. To be used with 30" H tiles. Order one 7½" H fabric tiles per pass-thru tile, if finishing only one side of panel.

! Must order a quantity of two (2) 7½" H fabric tiles per pass-thru tile, if finishing both sides of panel.

HOW TO SPECIFY

| | |
|---|---|
| <p>Select Model Number</p> <p>HRVT3024P</p> | <p>Select Paint Color</p> <p>See page 423</p> <p>T1</p> |
|---|---|

| DESCRIPTION | MODEL | SHIP WEIGHT | CUBE | LIST PRICE BY FABRIC GRADE | | | | | | | | |
|-----------------------------------|------------------|-------------|------|----------------------------|--------------|--------------|--------------|--------------|--------------|--------------|--------------|--|
| | | | | AA | A | B | C | D | E | F | G | |
| 7½" H Fabric Tackable Tile | | | | | | | | | | | | |
| 7½" H x 24" W | HRVT0724T | 2 ⑤ | 1.4 | \$70 | \$74 | \$77 | \$79 | \$85 | \$90 | \$95 | \$98 | |
| 7½" H x 30" W | HRVT0730T | 2 ⑤ | 1.8 | \$82 | \$86 | \$89 | \$93 | \$99 | \$106 | \$109 | \$112 | |
| 7½" H x 36" W | HRVT0736T | 2 ⑤ | 2.1 | \$88 | \$92 | \$95 | \$99 | \$105 | \$112 | \$115 | \$118 | |
| 7½" H x 42" W | HRVT0742T | 2 ⑤ | 2.4 | \$97 | \$102 | \$106 | \$110 | \$120 | \$123 | \$127 | \$131 | |
| 7½" H x 48" W | HRVT0748T | 2 ⑤ | 2.8 | \$103 | \$108 | \$112 | \$116 | \$126 | \$129 | \$133 | \$137 | |
| 7½" H x 60" W | HRVT0760T | 3 ⑤ | 3.4 | \$123 | \$143 | \$147 | \$152 | \$164 | \$168 | \$171 | \$174 | |

NOTES:

• Order one 7½" H fabric tiles per pass-thru tile, if finishing only one side of panel.

! Must order a quantity of two (2) 7½" H fabric tiles per pass-thru tile, if finishing both sides of panel.

HOW TO SPECIFY

| | |
|---|--|
| <p>Select Model Number</p> <p>HRVT0724T</p> | <p>Select Fabric Color</p> <p>See pages 424-425</p> <p>APN15</p> |
|---|--|



ABOUND[®] Slotted Tool Tiles

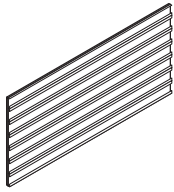

DESCRIPTION

15”H Slotted Tool Tiles

- 15”H x 24”W
- 15”H x 30”W
- 15”H x 36”W
- 15”H x 42”W
- 15”H x 48”W
- 15”H x 60”W

ⓘ Segment bars ordered separately. See page 448.

| MODEL | SHIP WEIGHT | CUBE | LIST PRICE BY PAINT GRADE | | |
|-----------|-------------|------|---------------------------|-------|-------|
| | | | P1 | P2 | P3 |
| HRVT1524W | 11 | 0.8 | \$289 | \$318 | \$341 |
| HRVT1530W | 13 | 0.9 | \$311 | \$340 | \$367 |
| HRVT1536W | 15 | 1.1 | \$332 | \$361 | \$392 |
| HRVT1542W | 17 | 1.3 | \$355 | \$384 | \$419 |
| HRVT1548W | 20 | 1.5 | \$375 | \$404 | \$442 |
| HRVT1560W | 24 | 1.8 | \$398 | \$427 | \$469 |

NOTES:

- Tiles made from sturdy aluminum extrusion and steel supports with a powder coat finish.
- Choose from hang-on accessories for a variety of organizational options. See page 466.
- ⓘ Tiles do not include segment bars, must be ordered separately. See page 448. Can be used in any combination.
- ⓘ Weight capacity of hang-on accessories should not exceed 80 pounds.

HOW TO SPECIFY

Select Model Number

HRVT1524W

Select Paint Color

See page 182 in the 2021 Shared Spaces Pricer
P1, P2, and P3 Paint Option

P8S



SYSTEMS PAPER MANAGEMENT SUPPORT BAR

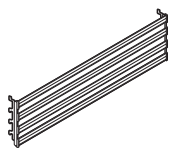

DESCRIPTION

Systems Paper Management Support Bars

- 24”W x 5”H
- 30”W x 5”H
- 36”W x 5”H
- 42”W x 5”H
- 48”W x 5”H
- 60”W x 5”H

ⓘ Recommended weight capacity not to exceed 80 pounds.

| MODEL | SHIP WEIGHT | CUBE | LIST PRICE BY PAINT GRADE | | |
|----------|-------------|------|---------------------------|-------|-------|
| | | | P1 | P2 | P3 |
| HNPBSW24 | 1.3 | 0.4 | \$210 | \$222 | \$232 |
| HNPBSW30 | 1.5 | 0.5 | \$224 | \$236 | \$246 |
| HNPBSW36 | 2.0 | 0.6 | \$232 | \$244 | \$254 |
| HNPBSW42 | 5.0 | 0.7 | \$244 | \$256 | \$266 |
| HNPBSW48 | 7.0 | 0.8 | \$254 | \$266 | \$276 |
| HNPBSW60 | 9.0 | 0.9 | \$289 | \$301 | \$311 |

NOTES:

- Paper management bar attaches to Systems Panels to accommodate work flow accessories.

HOW TO SPECIFY

Select Model Number

HNPBSW24

Select Paint Color

See page 182 in the 2021 Shared Spaces Pricer
P1, P2, and P3 Paint Option

P8S

SYSTEMS PAPER MANAGEMENT ACCESSORIES

GSA SIN 33721



Icon Legend on page 19

WORKSTATIONS

| | DESCRIPTION | MODEL | SHIP WEIGHT | CUBE | LIST PRICE BY PAINT GRADE | | |
|--|---|--------|-------------|------|---------------------------|-------|-------|
| | | | | | P1 | P2 | P3 |
|  | Accessories for Slotted Tool Tiles Paper Shelf 15"W x 9½"D x 2"H NOTES: Paper Shelf holds letter size paper and inter-office envelopes. | HPPMPS | 2 | 0.3 | \$110 | \$122 | \$133 |
|  | Accessory Shelf 21¾"W x 9"D x 2"H NOTES: Accessory Shelf holds office supplies and personal effects. | HPPMAS | 2 | 0.3 | \$114 | \$126 | \$137 |
|  | Tray 9"W x 10¾"D x 2"H | HPPMPT | 2 | 0.3 | \$139 | \$151 | \$162 |
|  | Pencil Holder 5¼"W x 1½"D x 5"H | HPPMPB | 1 | 0.2 | \$114 | \$126 | \$137 |
|  | Sorter Tray 6"W x 10"D x 2½"H NOTES: Sorter Tray provides 3 slots for organizing files. | HPPMST | 2 | 0.3 | \$150 | \$162 | \$173 |
|  | Folder Bin 12¼"W x 1¼"D x 9"H NOTES: Folder Bin accommodates manila envelopes and can be hung from other folder binds to maximize storage. | HPPMFB | 2 | 0.3 | \$114 | \$126 | \$137 |

NOTES:

- For use with Slotted Tool Tiles and Systems Paper Management Support Bars on page 465.

HOW TO SPECIFY

| | |
|-----------------------------------|---|
| <p>Select Model Number</p> | <p>Select Paint Color</p> <p>See page 182 in the 2021 Shared Spaces Pricer P1, P2, and P3 Paint Option</p> |
| <p>H P P M P S .</p> | <p>P 8 S</p> |



ABOUND[®] Markerboard Tiles

| | DESCRIPTION | MODEL | SHIP WEIGHT | CUBE | LIST PRICE |
|--|--|-----------|-------------|------|------------|
| | 15"H Markerboard Tiles | | | | |
| | 15"H x 24"W | HRVT1524M | 4 | 1.2 | \$263 |
| | 15"H x 30"W | HRVT1530M | 4 | 1.8 | \$281 |
| | 15"H x 36"W | HRVT1536M | 5 | 2.5 | \$295 |
| | 15"H x 42"W | HRVT1542M | 5 | 3.4 | \$313 |
| | 15"H x 48"W | HRVT1548M | 6 | 4.3 | \$322 |
| | 15"H x 60"W | HRVT1560M | 7 | 6.7 | \$334 |
| | 30"H Markerboard Tiles | | | | |
| | 30"H x 24"W | HRVT3024M | 6 | 1.2 | \$288 |
| | 30"H x 30"W | HRVT3030M | 7 | 1.8 | \$309 |
| | 30"H x 36"W | HRVT3036M | 8 | 2.5 | \$340 |
| | 30"H x 42"W | HRVT3042M | 10 | 3.4 | \$362 |
| | 30"H x 48"W | HRVT3048M | 11 | 4.3 | \$398 |
| | 30"H x 60"W | HRVT3060M | 13 | 6.7 | \$440 |
| | Magnetic Markerboard Tray 15" Natural Aluminum | HRVTRAYM | 4 | 0.4 | \$67 |
| | Natural Aluminum only, no need to specify paint. | | | | |

NOTES:

- Markerboard tile has a painted, steel surface.
- Accepts magnetic accessories.
- Markerboard tray attaches to the tile magnetically. Order separately.
- Tiles do not include segment bars, must be ordered separately. See page 448. Can be used in any combination.
- Markerboard cleaning instructions: For everyday cleaning, use Chlorox[®] wipes. Use citrus cleaner if a permanent marker is used by accident. A citrus cleaner is not recommended for everyday use as it leaves residue.

HOW TO SPECIFY

| | |
|--|--|
| <p>Select Model Number</p> <p>HRVT1524M</p> | <p>Select Paint Color</p> <p>X No Specification Needed</p> <p>X</p> |
|--|--|

ABOUND[®] Painted Metal Tiles

GSA SIN 33721



Icon Legend on page 19

WORKSTATIONS

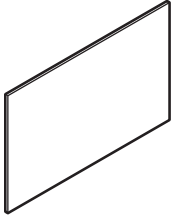

DESCRIPTION

15'H Painted Metal Tile

15"H x 24"W
15"H x 30"W
15"H x 36"W
15"H x 42"W
15"H x 48"W
15"H x 60"W

MODEL

SHIP WEIGHT

CUBE

LIST PRICE BY PAINT GRADE

P1

P2

| | | | | |
|------------|---|-----|-------|-------|
| HRVT1524PM | 4 | 1.2 | \$168 | \$189 |
| HRVT1530PM | 4 | 1.8 | \$180 | \$201 |
| HRVT1536PM | 5 | 2.5 | \$193 | \$214 |
| HRVT1542PM | 5 | 3.4 | \$209 | \$230 |
| HRVT1548PM | 6 | 4.3 | \$229 | \$250 |
| HRVT1560PM | 7 | 6.7 | \$253 | \$274 |

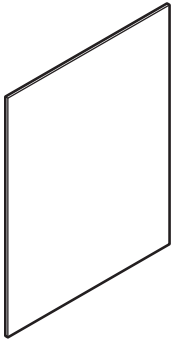

30'H Painted Metal Tile

30"H x 24"W
30"H x 30"W
30"H x 36"W
30"H x 42"W
30"H x 48"W
30"H x 60"W

| | | | | |
|------------|----|-----|-------|-------|
| HRVT3024PM | 6 | 1.2 | \$245 | \$278 |
| HRVT3030PM | 7 | 1.8 | \$267 | \$300 |
| HRVT3036PM | 8 | 2.5 | \$300 | \$333 |
| HRVT3042PM | 10 | 3.4 | \$322 | \$355 |
| HRVT3048PM | 11 | 4.3 | \$359 | \$392 |
| HRVT3060PM | 13 | 6.7 | \$402 | \$435 |

NOTES:

- Painted steel construction.

! Tiles do not include segment bars, must be ordered separately. See page 448. Can be used in any combination.

HOW TO SPECIFY

Select
Model Number

Select
Paint Color

See page 423

HRVT1524PM.

T3

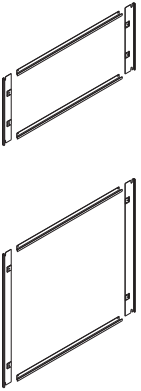

ABOUND® Custom Material Bracket Kit

| | DESCRIPTION | MODEL | SHIP WEIGHT | CUBE | LIST PRICE |
|---|---|------------|-------------|-------|------------|
|  | Custom Material Mounting Bracket Kit | | | | |
| | 15"H x 24"W | HRVT1524CK | 1 ☹ | 0.8 | \$75 |
| | 15"H x 30"W | HRVT1530CK | 1 ☹ | 0.9 | \$78 |
| | 15"H x 36"W | HRVT1536CK | 1 ☹ | 1.1 | \$84 |
| | 15"H x 42"W | HRVT1542CK | 1 ☹ | 1.3 | \$86 |
| | 15"H x 48"W | HRVT1548CK | 2 ☹ | 1.5 | \$92 |
| | 15"H x 60"W | HRVT1560CK | 2 ☹ | 1.8 | \$101 |
| | 30"H x 24"W | HRVT3024CK | 3 ☹ | 1.4 | \$75 |
| | 30"H x 30"W | HRVT3030CK | 3 ☹ | 1.8 | \$78 |
| | 30"H x 36"W | HRVT3036CK | 3 ☹ | 2.1 | \$84 |
| | 30"H x 42"W | HRVT3042CK | 4 ☹ | 2.4 | \$86 |
| | 30"H x 48"W | HRVT3048CK | 5 ☹ | 2.8 | \$92 |
| 30"H x 60"W | HRVT3060CK | 5 ☹ | 3.4 | \$101 | |

NOTES: Custom Material Bracket Kits can be ordered to use with Customer's Own Material. Please contact HON Customer Support for exact dimensions if further information is needed.

| | | | | | |
|---|-------------------|--------|-----|-----|------|
|  | Coat Hooks | | | | |
| | Package of six | HHPMC6 | 1 ☹ | 0.2 | \$94 |

NOTES: Compatible with Accelerate® and Abound® panels. Coat hooks hang directly into slotted Abound panel frame.
 ☹ Black only. Ship 6 per package.

HOW TO SPECIFY

Select Model Number

| | | | | | | | | | |
|---|---|---|---|---|---|---|---|---|---|
| H | R | V | T | 1 | 5 | 2 | 4 | C | K |
|---|---|---|---|---|---|---|---|---|---|

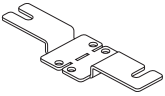
| | DESCRIPTION | MODEL | SHIP WEIGHT | CUBE | LIST PRICE |
|---|-------------------------------|--------|-------------|------|------------|
|  | Abound® Anchor Bracket | | | | |
| | Package of ten | HRABAB | 5 ☹ | 0.08 | \$95 |

NOTES: For use when panels need to be anchored to the floor such as high traffic areas or community spaces.
 ☹ Only available in Black (P).
 ☹ Only for use at the end of a wing panel.
SPECIFYING EXAMPLE: HRABAB.P

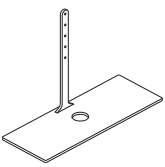
| | DESCRIPTION | MODEL | SHIP WEIGHT | | LIST PRICE BY PAINT GRADE | |
|---|--|--------|-------------|------|---------------------------|-------|
| | | | WEIGHT | CUBE | P1 | P2 |
|  | Abound® Stability Foot | HRFTAB | 3 | 0.1 | \$413 | \$423 |
| | NOTES: Stabilizes bottom of panel from movement. Will not prohibit movement at top of panel. ☹ Only for use at the end of a wing panel. | | | | | |

NOTES:

- ☹ The Anchor Bracket and Stability Foot are not intended to create a freestanding panel. Please follow Abound® stability standards.
- ☹ Attachment hardware for floor anchor not included.

HOW TO SPECIFY

| | | | | | | | |
|---|--------------------|---|---|---|---|---|--------------|
| Select Model Number | Select Paint Color | | | | | | |
| <table border="1"> <tr> <td>H</td><td>R</td><td>F</td><td>T</td><td>A</td><td>B</td> </tr> </table> | H | R | F | T | A | B | See page 423 |
| H | R | F | T | A | B | | |
| <table border="1"> <tr> <td>T</td><td>1</td> </tr> </table> | T | 1 | | | | | |
| T | 1 | | | | | | |

ABOUND[®] Gallery Panels — Wing

OPEN MARKET



Icon Legend on page 19

WORKSTATIONS

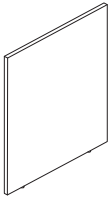

| DESCRIPTION | MODEL | SHIP WEIGHT | CUBE | LIST PRICE BY LAMINATE GRADE | |
|---|-----------|-------------|------|------------------------------|--------|
| | | | | L1 | L2 |
| Wing End of Run or Spanning End of Run | | | | | |
| 35"H x 27"W | HRVG3527L | 30.1 | 2.5 | \$388 | \$405 |
| 35"H x 33"W | HRVG3533L | 36.8 | 3.0 | \$472 | \$493 |
| 35"H x 39"W | HRVG3539L | 43.6 | 3.6 | \$534 | \$558 |
| 35"H x 45"W | HRVG3545L | 50.3 | 4.1 | \$593 | \$620 |
| 35"H x 51"W | HRVG3551L | 57.0 | 4.6 | \$639 | \$668 |
| 35"H x 63"W | HRVG3563L | 70.4 | 5.7 | \$727 | \$760 |
| 35"H x 75"W | HRVG3575L | 83.8 | 6.7 | \$883 | \$923 |
| 42"H x 27"W | HRVG4227L | 42.5 | 2.9 | \$421 | \$440 |
| 42"H x 33"W | HRVG4233L | 50.0 | 3.6 | \$511 | \$534 |
| 42"H x 39"W | HRVG4239L | 58.0 | 4.2 | \$581 | \$607 |
| 42"H x 45"W | HRVG4245L | 65.0 | 4.8 | \$627 | \$655 |
| 42"H x 51"W | HRVG4251L | 73.5 | 5.4 | \$694 | \$725 |
| 42"H x 63"W | HRVG4263L | 89.0 | 6.7 | \$780 | \$815 |
| 42"H x 75"W | HRVG4275L | 104.5 | 7.9 | \$900 | \$941 |
| 50"H x 27"W | HRVG5027L | 49.0 | 3.5 | \$484 | \$506 |
| 50"H x 33"W | HRVG5033L | 58.0 | 4.2 | \$567 | \$593 |
| 50"H x 39"W | HRVG5039L | 67.5 | 4.9 | \$632 | \$661 |
| 50"H x 45"W | HRVG5045L | 77.0 | 5.6 | \$715 | \$747 |
| 50"H x 51"W | HRVG5051L | 86.0 | 6.4 | \$752 | \$786 |
| 50"H x 63"W | HRVG5063L | 104.5 | 7.8 | \$845 | \$883 |
| 50"H x 75"W | HRVG5075L | 123.0 | 9.3 | \$979 | \$1023 |

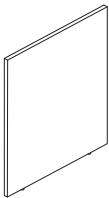

| | | | | | |
|--------------------|-----------|-------|-----|-------|-------|
| Wing Middle | | | | | |
| 35"H x 24"W | HRVG3524L | 26.8 | 2.4 | \$368 | \$384 |
| 35"H x 30"W | HRVG3530L | 33.5 | 2.9 | \$449 | \$469 |
| 35"H x 36"W | HRVG3536L | 40.2 | 3.3 | \$500 | \$522 |
| 35"H x 42"W | HRVG3542L | 46.9 | 3.8 | \$559 | \$584 |
| 35"H x 48"W | HRVG3548L | 53.6 | 4.4 | \$617 | \$645 |
| 35"H x 60"W | HRVG3560L | 67.0 | 5.4 | \$711 | \$743 |
| 42"H x 24"W | HRVG4224L | 38.5 | 2.6 | \$399 | \$417 |
| 42"H x 30"W | HRVG4230L | 46.0 | 3.3 | \$486 | \$508 |
| 42"H x 36"W | HRVG4236L | 54.0 | 3.9 | \$542 | \$567 |
| 42"H x 42"W | HRVG4242L | 62.0 | 4.5 | \$606 | \$633 |
| 42"H x 48"W | HRVG4248L | 69.5 | 5.1 | \$652 | \$682 |
| 42"H x 60"W | HRVG4260L | 85.0 | 6.3 | \$761 | \$795 |
| 50"H x 24"W | HRVG5024L | 44.5 | 3.1 | \$459 | \$480 |
| 50"H x 30"W | HRVG5030L | 53.0 | 3.8 | \$540 | \$564 |
| 50"H x 36"W | HRVG5036L | 63.0 | 4.6 | \$596 | \$623 |
| 50"H x 42"W | HRVG5042L | 72.0 | 5.3 | \$666 | \$696 |
| 50"H x 48"W | HRVG5048L | 81.5 | 6.0 | \$734 | \$767 |
| 50"H x 60"W | HRVG5060L | 100.0 | 7.5 | \$828 | \$866 |

NOTES:

- Gallery Panels come standard with two adjustable leveling glides.
- When specifying Wing End of Run panels, the Gallery Panels are 3" wider to allow for the panel to cover the width of the spine.
- Mid-configuration creates 1½" space between the system panels. This gap matches the thickness of the Gallery Panel.
- Wing End of Run widths of 51", 63", and 75"W can be used as spanning end of run configurations.
- Gallery Panels come standard with two adjustable leveling glides.
- Gallery Panels require connectors to attach to the spine of the panel. See connectors on page 473.
- Gallery Panels up to 60"W can specify vertical or horizontal woodgrain direction. Panels larger than 60"W will have horizontal woodgrain.
- ! Minimum panel length must be 50% of the Gallery Panel for stability.
- ! When system panel is higher than the Gallery Panel, system's variable height trim kit must be specified to finish off the exposed frame.
- ! Standard Gallery Panels can only connect to standard panel frames. Use Gallery-to-Gallery Panels to connect Standard Gallery Panels to other Gallery Panels.
- ! Gallery Panels longer than 60"W require a floor or storage support.

HOW TO SPECIFY

| | | | | |
|--|--|--|---|--|
| <p>Select Model Number</p> <p>HRVG3527L</p> | <p>Select Laminate</p> <p>See page 423</p> <p>C</p> | <p>Select Edge</p> <p>See page 423</p> <p>C</p> | <p>Select Grain Direction</p> <p>VST Vertical Grain (not available on 63"W or wider) VLG Horizontal Grain and Solid Laminate only</p> <p>VST</p> | <p>Select Glide</p> <p>G Glide</p> <p>G</p> |
|--|--|--|---|--|



Gallery Panels — Wing, Accepts Glass

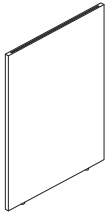

| DESCRIPTION | MODEL | SHIP WEIGHT | CUBE | LIST PRICE BY LAMINATE GRADE | |
|--|------------|-------------|------|------------------------------|--------|
| | | | | L1 | L2 |
| Wing End of Run or Spanning End of Run, Accepts Glass | | | | | |
| 35”H x 27”W | HRVG3527LG | 30.1 | 2.5 | \$527 | \$551 |
| 35”H x 33”W | HRVG3533LG | 36.8 | 3.0 | \$611 | \$638 |
| 35”H x 39”W | HRVG3539LG | 43.6 | 3.6 | \$675 | \$705 |
| 35”H x 45”W | HRVG3545LG | 50.3 | 4.1 | \$732 | \$765 |
| 35”H x 51”W | HRVG3551LG | 57.0 | 4.6 | \$776 | \$811 |
| 35”H x 63”W | HRVG3563LG | 70.4 | 5.7 | \$867 | \$906 |
| 35”H x 75”W | HRVG3575LG | 83.8 | 6.7 | \$1019 | \$1065 |
| 42”H x 27”W | HRVG4227LG | 42.5 | 2.9 | \$560 | \$585 |
| 42”H x 33”W | HRVG4233LG | 50.0 | 3.6 | \$650 | \$679 |
| 42”H x 39”W | HRVG4239LG | 58.0 | 4.2 | \$718 | \$751 |
| 42”H x 45”W | HRVG4245LG | 66.0 | 4.8 | \$766 | \$801 |
| 42”H x 51”W | HRVG4251LG | 73.5 | 5.4 | \$832 | \$870 |
| 42”H x 63”W | HRVG4263LG | 89.0 | 6.7 | \$918 | \$960 |
| 42”H x 75”W | HRVG4275LG | 104.5 | 7.9 | \$1037 | \$1084 |
| 50”H x 27”W | HRVG5027LG | 49.0 | 3.5 | \$622 | \$650 |
| 50”H x 33”W | HRVG5033LG | 58.0 | 4.2 | \$705 | \$737 |
| 50”H x 39”W | HRVG5039LG | 67.5 | 4.9 | \$770 | \$805 |
| 50”H x 45”W | HRVG5045LG | 77.0 | 5.6 | \$853 | \$892 |
| 50”H x 51”W | HRVG5051LG | 86.0 | 6.4 | \$890 | \$930 |
| 50”H x 63”W | HRVG5063LG | 104.5 | 7.8 | \$983 | \$1028 |
| 50”H x 75”W | HRVG5075LG | 123.0 | 9.3 | \$1118 | \$1169 |

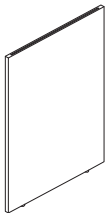

| DESCRIPTION | MODEL | SHIP WEIGHT | CUBE | LIST PRICE BY LAMINATE GRADE | |
|-----------------------------------|------------|-------------|------|------------------------------|--------|
| | | | | L1 | L2 |
| Wing Middle, Accepts Glass | | | | | |
| 35”H x 24”W | HRVG3524LG | 26.8 | 2.4 | \$507 | \$530 |
| 35”H x 30”W | HRVG3530LG | 33.5 | 2.9 | \$588 | \$614 |
| 35”H x 36”W | HRVG3536LG | 40.2 | 3.3 | \$640 | \$669 |
| 35”H x 42”W | HRVG3542LG | 46.9 | 3.8 | \$698 | \$729 |
| 35”H x 48”W | HRVG3548LG | 53.6 | 4.4 | \$756 | \$790 |
| 35”H x 60”W | HRVG3560LG | 67.0 | 5.4 | \$852 | \$890 |
| 42”H x 24”W | HRVG4224LG | 38.5 | 2.6 | \$537 | \$561 |
| 42”H x 30”W | HRVG4230LG | 46.0 | 3.3 | \$625 | \$653 |
| 42”H x 36”W | HRVG4236LG | 54.0 | 3.9 | \$681 | \$712 |
| 42”H x 42”W | HRVG4242LG | 62.0 | 4.5 | \$744 | \$778 |
| 42”H x 48”W | HRVG4248LG | 69.5 | 5.1 | \$790 | \$826 |
| 42”H x 60”W | HRVG4260LG | 85.0 | 6.3 | \$897 | \$938 |
| 50”H x 24”W | HRVG5024LG | 44.5 | 3.1 | \$597 | \$624 |
| 50”H x 30”W | HRVG5030LG | 54.0 | 3.8 | \$678 | \$709 |
| 50”H x 36”W | HRVG5036LG | 63.0 | 4.6 | \$735 | \$768 |
| 50”H x 42”W | HRVG5042LG | 72.0 | 5.3 | \$805 | \$842 |
| 50”H x 48”W | HRVG5048LG | 81.5 | 6.0 | \$853 | \$893 |
| 50”H x 60”W | HRVG5060LG | 100.0 | 7.5 | \$966 | \$1010 |

NOTES:

- Gallery Panels come standard with two adjustable leveling glides.
- When specifying Wing End of Run panels, the Gallery Panels are 3” wider to allow for the panel to cover the width of the spine.
- Mid-configuration creates 1½” space between the system panels. This gap matches the thickness of the Gallery Panel.
- Wing End of Run widths of 51”, 63”, and 75”W can be used as spanning end of run configurations.
- Gallery Panels come standard with two adjustable leveling glides.
- Gallery Panels require connectors to attach to the spine of the panel. See connectors on page 473.
- Gallery Panels up to 60”W can specify vertical or horizontal woodgrain direction. Panels larger than 60”W will have horizontal woodgrain.
- ! Minimum panel length must be 50% of the Gallery Panel for stability.
- ! When system panel is higher than the Gallery Panel, system’s variable height trim kit must be specified to finish off the exposed frame.
- ! Standard Gallery Panels can only connect to standard panel frames. Use Gallery-to-Gallery Panels to connect STANDARD Gallery Panels to other Gallery Panels.
- ! Gallery Panels longer than 60”W require a floor or storage support.

HOW TO SPECIFY

| | | | | |
|--|---|---|--|---|
| <p>Select Model Number</p> <p>HRVG3527LG</p> | <p>Select Laminate</p> <p>See page 423</p> <p>C</p> | <p>Select Edge</p> <p>See page 423</p> <p>C</p> | <p>Select Grain Direction</p> <p>VST Vertical Grain (not available on 63”W or wider) VLG Horizontal Grain and Solid Laminate only</p> <p>VST</p> | <p>Select Glide</p> <p>G Glide</p> <p>G</p> |
|--|---|---|--|---|

ABOUND[®] Gallery Glass

OPEN MARKET



Icon Legend on page 19

WORKSTATIONS

| | DESCRIPTION | MODEL | SHIP WEIGHT | CUBE | CLEAR GLASS | FROSTED GLASS |
|--|--|----------------------------------|-------------|------|--------------|---------------|
| | 7½”H Gallery Glass, Wing, End of Run | | | | | |
| | 7½”H x 24”W, For 27”D Panels | SPLH-ABND-GALGLSS.M482172 | 9.0 | 0.7 | \$397 | \$434 |
| | 7½”H x 30”W, For 33”D Panels | SPLH-ABND-GALGLSS.M482174 | 10.5 | 0.9 | \$420 | \$457 |
| | 7½”H x 36”W, For 39”D Panels | SPLH-ABND-GALGLSS.M482176 | 12.0 | 1.1 | \$481 | \$518 |
| | 7½”H x 42”W, For 45”D Panels | SPLH-ABND-GALGLSS.M482178 | 13.0 | 1.3 | \$508 | \$545 |
| | 7½”H x 48”W, For 51”D Panels | SPLH-ABND-GALGLSS.M482180 | 14.5 | 1.5 | \$561 | \$598 |
| | 7½”H x 60”W, For 63”D Panels | SPLH-ABND-GALGLSS.M482182 | 17.0 | 1.8 | \$660 | \$697 |
| | 7½”H Gallery Glass, Middle | | | | | |
| | 7½”H x 21”W, For 24”D Panels | SPLH-ABND-GALGLSS.M482171 | 8.0 | 0.7 | \$387 | \$424 |
| | 7½”H x 27”W, For 30”D Panels | SPLH-ABND-GALGLSS.M482173 | 10.0 | 0.8 | \$409 | \$446 |
| | 7½”H x 33”W, For 36”D Panels | SPLH-ABND-GALGLSS.M482175 | 11.0 | 1.0 | \$430 | \$467 |
| | 7½”H x 39”W, For 42”D Panels | SPLH-ABND-GALGLSS.M482177 | 12.5 | 1.2 | \$493 | \$530 |
| | 7½”H x 45”W, For 48”D Panels | SPLH-ABND-GALGLSS.M482179 | 14.0 | 1.4 | \$540 | \$577 |
| | 7½”H x 57”W, For 60”D Panels | SPLH-ABND-GALGLSS.M482181 | 16.0 | 1.7 | \$649 | \$686 |
| NOTES: Compatible with Gallery-to-Gallery connections, see page 475-478. | | | | | | |
| | 7½”H Gallery Glass, Spanning End of Run | | | | | |
| | 7½”H x 48”W, For 51”D Panels | SPLH-ABND-GALGLSS.M482180 | 14.5 | 1.5 | \$561 | \$598 |
| | 7½”H x 60”W, For 63”D Panels | SPLH-ABND-GALGLSS.M482182 | 17.0 | 1.8 | \$660 | \$697 |
| | 7½”H x 72”W, For 75”D Panels | SPLH-ABND-GALGLSS.M482183 | 19.5 | 2.2 | \$780 | \$817 |

NOTES:

- Gallery Panels are 3” wider than corresponding glass to allow for proper fit and function.
- Glass is inset 1½” from end of Standard Gallery Panels. Gallery-to-Gallery Panels have ½” glass inset.

- ❗ Cannot hang or stack on top of Frameless Glass.
- ❗ Frameless Glass can only be used on the top of Gallery Panels. Glass integrates into notch cutout in the top of the panel.

HOW TO SPECIFY

| | |
|---|---|
| <p>Select Model Number</p> <p>S P L H - A B N D - G A L G L S S . M 4 8 2 1 7 1 .</p> | <p>Select Glass</p> <p>Q Clear Glass R Frosted Glass</p> <p>Q</p> |
|---|---|

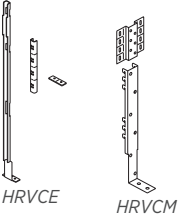

ABOUND[®] Gallery Connector Kits

| | DESCRIPTION | MODEL | SHIP WEIGHT | CUBE | LIST PRICE BY PAINT GRADE | |
|---|-------------------------------------|--------------|-------------|------|---------------------------|--------------|
| | | | | | P1 | P2 |
|  | Gallery Panel Connectors | | | | | |
| | Spanning End of Run and L Connector | HRVCE | 0.83 | 0.1 | \$83 | \$90 |
| | Wing Middle Attachment Brackets | HRVCM | 0.62 | 0.1 | \$96 | \$105 |

| | DESCRIPTION | MODEL | SHIP WEIGHT | CUBE | LIST PRICE |
|---|-------------------------------|-----------------|-------------|------|--------------|
|  | Gallery Connector Kits | | | | |
| | 35" | HRVC35GP | 1.0 | 0.3 | \$193 |
| | 42" | HRVC42GP | 1.5 | 0.4 | \$215 |
| | 50" | HRVC50GP | 1.5 | 0.5 | \$225 |
| | 65" | HRVC65GP | 2.0 | 0.6 | \$261 |

| | DESCRIPTION | MODEL | SHIP WEIGHT | CUBE | LIST PRICE |
|--|--------------------------------------|----------------|-------------|------|-------------|
|  | Gallery Panel-to-Storage Kits | | | | |
| | Laminate Storage Ganging Kit | HRVGLSK | 0.1 | 0.1 | \$46 |
| | Metal Storage Ganging Kit | HRVGMSK | 0.1 | 0.1 | \$10 |

NOTES:

- HRVCE is used in L and spanning (T) end of run applications.
- Wing Middle Connector Kits accommodate both single-sided and dual-sided applications.
- For more rigidity, the Gallery Panel can be tied to a storage or a non-adjustable surface. Use HRVGLSK for laminate or HRVGMSK for metal storage.
- HAT bases can be tied to Gallery Panels using HAT-to-Gallery brackets on page 479.
- ! Wing Middle Connector Kits must be used in any Wing Middle application in conjunction with model HRVCM.
- ! Wing Middle Connector Kits are required for Wing Middle applications and are used only with Wing Middle Gallery Panels.
- ! Gallery Panels can only connect to standard panel frames; Gallery Panels cannot connect to each other.

HOW TO SPECIFY

| | |
|---|--|
| <p>Select Model Number</p> <p>HRVC42GP</p> | <p>Select Paint Color</p> <p>See page 423</p> <p>T1</p> |
|---|--|

| |
|--|
| <p>Select Model Number</p> <p>HRVGMSK</p> |
|--|

ABOUND® Gallery Panel Tackboards

OPEN MARKET



Icon Legend on page 19

WORKSTATIONS

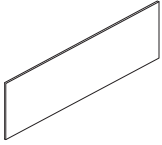

| DESCRIPTION | MODEL | SHIP WEIGHT | CUBE | LIST PRICE BY FABRIC GRADE | | | | | | | | |
|---------------------------------|----------------|-------------|------|----------------------------|-------|-------|-------|-------|-------|-------|-------|--|
| | | | | AA | A | B | C | D | E | F | G | |
| Gallery Panel Tackboards | | | | | | | | | | | | |
| 36"W x 11"H | HRVTB11 | 7 | 1.1 | \$280 | \$285 | \$288 | \$291 | \$294 | \$299 | \$304 | \$309 | |
| 36"W x 18½"H | HRVTB18 | 10 | 1.8 | \$329 | \$334 | \$337 | \$340 | \$343 | \$348 | \$353 | \$358 | |

NOTES:

- Tackboard attaches to Gallery Panel by screwing painted metal frame onto Gallery Panel surface. Fabric insert attaches to painted metal frame with hook and loop.
- Attachment hardware for Tackboard is provided.

! No template is provided for placement and leveling of Tackboard.

HOW TO SPECIFY

| | |
|----------------------------|----------------------|
| Select Model Number | Select Fabric |
| | See pages 424-425 |
| HRVTB11 | APN11 |



Icon Legend on page 19

ABOUT® Gallery-to-Gallery Connections

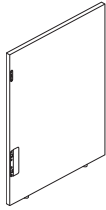

| DESCRIPTION | MODEL | SHIP WEIGHT | CUBE | LIST PRICE BY LAMINATE GRADE | |
|----------------------------------|-------------|-------------|------|------------------------------|--------|
| | | | | L1 | L2 |
| L-Connections, Right Hand | | | | | |
| 35"H x 18"W | HRVG3518GGR | 23.6 | 2.0 | \$612 | \$637 |
| 35"H x 24"W | HRVG3524GGR | 30.5 | 2.6 | \$660 | \$687 |
| 35"H x 30"W | HRVG3530GGR | 37.4 | 3.1 | \$712 | \$741 |
| 35"H x 36"W | HRVG3536GGR | 44.3 | 3.6 | \$764 | \$795 |
| 35"H x 42"W | HRVG3542GGR | 51.1 | 4.1 | \$820 | \$854 |
| 35"H x 48"W | HRVG3548GGR | 58.0 | 4.7 | \$881 | \$918 |
| 35"H x 60"W | HRVG3560GGR | 71.8 | 5.7 | \$945 | \$985 |
| 42"H x 18"W | HRVG4218GGR | 28.5 | 2.4 | \$636 | \$662 |
| 42"H x 24"W | HRVG4224GGR | 36.9 | 3.0 | \$686 | \$714 |
| 42"H x 30"W | HRVG4230GGR | 45.3 | 3.7 | \$740 | \$770 |
| 42"H x 36"W | HRVG4236GGR | 53.7 | 4.3 | \$798 | \$831 |
| 42"H x 42"W | HRVG4242GGR | 62.1 | 4.9 | \$863 | \$899 |
| 42"H x 48"W | HRVG4248GGR | 70.5 | 5.6 | \$931 | \$970 |
| 42"H x 60"W | HRVG4260GGR | 87.3 | 6.8 | \$1001 | \$1043 |
| 50"H x 18"W | HRVG5018GGR | 33.4 | 2.8 | \$686 | \$714 |
| 50"H x 24"W | HRVG5024GGR | 43.3 | 3.5 | \$740 | \$770 |
| 50"H x 30"W | HRVG5030GGR | 53.2 | 4.3 | \$798 | \$831 |
| 50"H x 36"W | HRVG5036GGR | 63.1 | 5.0 | \$857 | \$893 |
| 50"H x 42"W | HRVG5042GGR | 73.1 | 5.7 | \$920 | \$958 |
| 50"H x 48"W | HRVG5048GGR | 83.0 | 6.5 | \$988 | \$1030 |
| 50"H x 60"W | HRVG5060GGR | 102.8 | 7.9 | \$1062 | \$1107 |

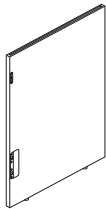

| DESCRIPTION | MODEL | SHIP WEIGHT | CUBE | LIST PRICE BY LAMINATE GRADE | |
|---|--------------|-------------|------|------------------------------|--------|
| | | | | L1 | L2 |
| L-Connections, Right Hand, Accepts Glass | | | | | |
| 35"H x 18"W | HRVG3518GGRG | 23.6 | 2.0 | \$707 | \$736 |
| 35"H x 24"W | HRVG3524GGRG | 30.5 | 2.6 | \$763 | \$794 |
| 35"H x 30"W | HRVG3530GGRG | 37.4 | 3.1 | \$824 | \$858 |
| 35"H x 36"W | HRVG3536GGRG | 44.3 | 3.6 | \$885 | \$922 |
| 35"H x 42"W | HRVG3542GGRG | 51.1 | 4.1 | \$950 | \$990 |
| 35"H x 48"W | HRVG3548GGRG | 58.0 | 4.7 | \$1021 | \$1064 |
| 35"H x 60"W | HRVG3560GGRG | 71.8 | 5.7 | \$1097 | \$1143 |
| 42"H x 18"W | HRVG4218GGRG | 28.4 | 2.4 | \$723 | \$753 |
| 42"H x 24"W | HRVG4224GGRG | 36.9 | 3.0 | \$781 | \$813 |
| 42"H x 30"W | HRVG4230GGRG | 45.3 | 3.7 | \$844 | \$879 |
| 42"H x 36"W | HRVG4236GGRG | 53.7 | 4.3 | \$911 | \$949 |
| 42"H x 42"W | HRVG4242GGRG | 62.1 | 4.9 | \$985 | \$1026 |
| 42"H x 48"W | HRVG4248GGRG | 70.5 | 5.6 | \$1064 | \$1109 |
| 42"H x 60"W | HRVG4260GGRG | 87.3 | 6.8 | \$1145 | \$1194 |
| 50"H x 18"W | HRVG5018GGRG | 33.4 | 2.8 | \$763 | \$794 |
| 50"H x 24"W | HRVG5024GGRG | 43.3 | 3.5 | \$824 | \$858 |
| 50"H x 30"W | HRVG5030GGRG | 53.2 | 4.3 | \$889 | \$926 |
| 50"H x 36"W | HRVG5036GGRG | 63.1 | 5.0 | \$955 | \$995 |
| 50"H x 42"W | HRVG5042GGRG | 73.1 | 5.7 | \$1026 | \$1069 |
| 50"H x 48"W | HRVG5048GGRG | 83.0 | 6.5 | \$1103 | \$1150 |
| 50"H x 60"W | HRVG5060GGRG | 102.8 | 7.9 | \$1186 | \$1236 |

NOTES:

- Gallery-to-Gallery Panels connect to other Gallery Panels and are available in L-, T-, and Non-symmetrical T-configurations.
- When specifying Gallery-to-Gallery Panels, the installation template (HRVGTGG) is required. The recommendation is one template for every 30 panels. Templates are reusable.
- Gallery-to-Gallery Panels must be of equal or lower height than the Standard Gallery Panel attached. The Gallery-to-Gallery Panel cannot be taller than the adjacent panel. If this is needed, please reach out to Tailored Solutions for a custom solution.
- Made of 1/8" board with HPL laminate.
- Can be specified with matching or contrasting edge.
- Edgeband is 2mm ABS.
- Available in woodgrain and solid laminates.
- Woodgrain laminates can be specified with vertical grain up to 48"W. Horizontal grain is available on all sizes.
- Gallery-to-Gallery Panel widths are available in 18", 24", 30", 36", 42", 48", and 60"W.
- Gallery Panels offer 2 1/2" leveling capability.
- Overall heights line up with adjacent panel.
- Gallery-to-Gallery Panels cap over Standard Gallery Panels and are oversized by 1/8" to maintain true interior dimensions.
- Available with or without the integrated glass option.
- Glass specified separately, see 7 1/2"H Gallery Glass on page 472.
- Gallery Panels for use with glass have separate model numbers.
- Gallery-to-Gallery Panels are secured with an inset flat bracket under a painted metal cover.
- L-panels are handed.

HOW TO SPECIFY

| | | | | | |
|--|--|--|--|---|--|
| <p>Select Model Number</p> <p>HRVG4236GGR</p> | <p>Select Laminate</p> <p>See page 423</p> <p>H</p> | <p>Select Edge</p> <p>See page 423</p> <p>H</p> | <p>Select Grain Direction</p> <p>VLG Horizontal Grain and Solid Laminate only VST Vertical Grain</p> <p>VLG</p> | <p>Select Paint Color</p> <p>See page 423</p> <p>P8T</p> | <p>Select Glide</p> <p>G Glide</p> <p>G</p> |
|--|--|--|--|---|--|

ABOUND[®] Gallery-to-Gallery Connections

OPEN MARKET



Icon Legend on page 19

WORKSTATIONS

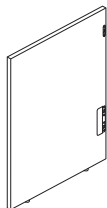

| DESCRIPTION | MODEL | SHIP WEIGHT | CUBE | LIST PRICE BY LAMINATE GRADE | |
|--|---------------|-------------|------|------------------------------|--------|
| | | | | L1 | L2 |
| L-Connections, Left Hand | | | | | |
| 35"H x 18"W | HRVG3518GGGL | 23.6 | 2.0 | \$612 | \$637 |
| 35"H x 24"W | HRVG3524GGGL | 30.5 | 2.6 | \$660 | \$687 |
| 35"H x 30"W | HRVG3530GGGL | 37.4 | 3.1 | \$712 | \$741 |
| 35"H x 36"W | HRVG3536GGGL | 44.3 | 3.6 | \$764 | \$795 |
| 35"H x 42"W | HRVG3542GGGL | 51.1 | 4.1 | \$820 | \$854 |
| 35"H x 48"W | HRVG3548GGGL | 58.0 | 4.7 | \$881 | \$918 |
| 35"H x 60"W | HRVG3560GGGL | 71.8 | 5.7 | \$945 | \$985 |
| 42"H x 18"W | HRVG4218GGGL | 28.5 | 2.4 | \$636 | \$662 |
| 42"H x 24"W | HRVG4224GGGL | 36.9 | 3.0 | \$686 | \$714 |
| 42"H x 30"W | HRVG4230GGGL | 45.3 | 3.7 | \$740 | \$770 |
| 42"H x 36"W | HRVG4236GGGL | 53.7 | 4.3 | \$798 | \$831 |
| 42"H x 42"W | HRVG4242GGGL | 62.1 | 4.9 | \$863 | \$899 |
| 42"H x 48"W | HRVG4248GGGL | 70.5 | 5.6 | \$931 | \$970 |
| 42"H x 60"W | HRVG4260GGGL | 87.3 | 6.8 | \$1001 | \$1043 |
| 50"H x 18"W | HRVG5018GGGL | 33.4 | 2.8 | \$686 | \$714 |
| 50"H x 24"W | HRVG5024GGGL | 43.3 | 3.5 | \$740 | \$770 |
| 50"H x 30"W | HRVG5030GGGL | 53.2 | 4.3 | \$798 | \$831 |
| 50"H x 36"W | HRVG5036GGGL | 63.1 | 5.0 | \$857 | \$893 |
| 50"H x 42"W | HRVG5042GGGL | 73.1 | 5.7 | \$920 | \$958 |
| 50"H x 48"W | HRVG5048GGGL | 83.0 | 6.5 | \$988 | \$1030 |
| 50"H x 60"W | HRVG5060GGGL | 102.8 | 7.9 | \$1062 | \$1107 |
| L-Connections, Left Hand, Accepts Glass | | | | | |
| 35"H x 18"W | HRVG3518GGGLG | 23.6 | 2.0 | \$707 | \$736 |
| 35"H x 24"W | HRVG3524GGGLG | 30.5 | 2.6 | \$763 | \$794 |
| 35"H x 30"W | HRVG3530GGGLG | 37.4 | 3.1 | \$824 | \$858 |
| 35"H x 36"W | HRVG3536GGGLG | 44.3 | 3.6 | \$885 | \$922 |
| 35"H x 42"W | HRVG3542GGGLG | 51.1 | 4.1 | \$950 | \$990 |
| 35"H x 48"W | HRVG3548GGGLG | 58.0 | 4.7 | \$1021 | \$1064 |
| 35"H x 60"W | HRVG3560GGGLG | 71.8 | 5.7 | \$1097 | \$1143 |
| 42"H x 18"W | HRVG4218GGGLG | 28.4 | 2.4 | \$723 | \$753 |
| 42"H x 24"W | HRVG4224GGGLG | 36.9 | 3.0 | \$781 | \$813 |
| 42"H x 30"W | HRVG4230GGGLG | 45.3 | 3.7 | \$844 | \$879 |
| 42"H x 36"W | HRVG4236GGGLG | 53.7 | 4.3 | \$911 | \$949 |
| 42"H x 42"W | HRVG4242GGGLG | 62.1 | 4.9 | \$985 | \$1026 |
| 42"H x 48"W | HRVG4248GGGLG | 70.5 | 5.6 | \$1064 | \$1109 |
| 42"H x 60"W | HRVG4260GGGLG | 87.3 | 6.8 | \$1145 | \$1194 |
| 50"H x 18"W | HRVG5018GGGLG | 33.4 | 2.8 | \$763 | \$794 |
| 50"H x 24"W | HRVG5024GGGLG | 43.3 | 3.5 | \$824 | \$858 |
| 50"H x 30"W | HRVG5030GGGLG | 53.2 | 4.3 | \$889 | \$926 |
| 50"H x 36"W | HRVG5036GGGLG | 63.1 | 5.0 | \$955 | \$995 |
| 50"H x 42"W | HRVG5042GGGLG | 73.1 | 5.7 | \$1026 | \$1069 |
| 50"H x 48"W | HRVG5048GGGLG | 83.0 | 6.5 | \$1103 | \$1150 |
| 50"H x 60"W | HRVG5060GGGLG | 102.8 | 7.9 | \$1186 | \$1236 |

NOTES:

- Gallery-to-Gallery Panels connect to other Gallery Panels and are available in L-, T-, and Non-symmetrical T-configurations.
- When specifying Gallery-to-Gallery Panels, the installation template (HRVGTGG) is required. The recommendation is one template for every 30 panels. Templates are reusable.
- Gallery-to-Gallery Panels must be of equal or lower height than the Standard Gallery Panel attached. The Gallery-to-Gallery Panel cannot be taller than the adjacent panel. If this is needed, please reach out to Tailored Solutions for a custom solution.
- Made of 1/8" board with HPL laminate.
- Can be specified with matching or contrasting edge.
- Edgeband is 2mm ABS.
- Available in woodgrain and solid laminates.
- Woodgrain laminates can be specified with vertical grain up to 48"W. Horizontal grain is available on all sizes.
- Gallery-to-Gallery Panel widths are available in 18", 24", 30", 36", 42", 48", and 60"W.
- Gallery Panels offer 2 1/2" leveling capability.
- Overall heights line up with adjacent panel.
- Gallery-to-Gallery Panels cap over Standard Gallery Panels and are oversized by 1/8" to maintain true interior dimensions.
- Available with or without the integrated glass option.
- Glass specified separately, see 7 1/2"H Gallery Glass on page 472.
- Gallery Panels for use with glass have separate model numbers.
- Gallery-to-Gallery Panels are secured with an inset flat bracket under a painted metal cover.
- L-panels are handed.

HOW TO SPECIFY

| | | | | | |
|---|---|---|---|--|---|
| <p>Select Model Number</p> <p>HRVG4236GGGLG</p> | <p>Select Laminate</p> <p>See page 423</p> <p>H</p> | <p>Select Edge</p> <p>See page 423</p> <p>H</p> | <p>Select Grain Direction</p> <p>VLG Horizontal Grain and Solid Laminate only VST Vertical Grain</p> <p>VLG</p> | <p>Select Paint Color</p> <p>See page 423</p> <p>P8T</p> | <p>Select Glide</p> <p>G Glide</p> <p>G</p> |
|---|---|---|---|--|---|



Icon Legend on page 19

ABOUT® Gallery-to-Gallery Connections

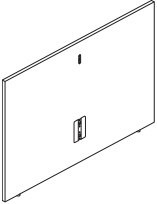
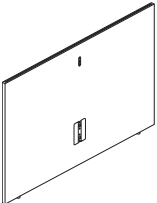
| DESCRIPTION | MODEL | SHIP WEIGHT | CUBE | LIST PRICE BY LAMINATE GRADE | |
|--|--------------|-------------|------|------------------------------|--------|
| | | | | L1 | L2 |
| T-Connections | | | | | |
|  35"H x 18"W | HRVG3518GGT | 23.6 | 2.0 | \$703 | \$729 |
| 35"H x 36"W | HRVG3536GGT | 44.3 | 3.6 | \$862 | \$895 |
| 35"H x 42"W | HRVG3542GGT | 51.1 | 4.1 | \$921 | \$957 |
| 35"H x 48"W | HRVG3548GGT | 58.0 | 4.7 | \$984 | \$1023 |
| 35"H x 60"W | HRVG3560GGT | 71.8 | 5.7 | \$1052 | \$1094 |
| 35"H x 72"W | HRVG3572GGT | 85.5 | 6.8 | \$1137 | \$1182 |
| | | | | | |
| 42"H x 18"W | HRVG4218GGT | 28.5 | 2.4 | \$728 | \$755 |
| 42"H x 36"W | HRVG4236GGT | 53.7 | 4.3 | \$897 | \$932 |
| 42"H x 42"W | HRVG4242GGT | 62.1 | 4.9 | \$964 | \$1002 |
| 42"H x 48"W | HRVG4248GGT | 70.5 | 5.6 | \$1038 | \$1079 |
| 42"H x 60"W | HRVG4260GGT | 87.3 | 6.8 | \$1110 | \$1154 |
| 42"H x 72"W | HRVG4272GGT | 104.1 | 8.1 | \$1214 | \$1263 |
| | | | | | |
| 50"H x 18"W | HRVG5018GGT | 33.4 | 2.8 | \$779 | \$808 |
| 50"H x 36"W | HRVG5036GGT | 63.1 | 5.0 | \$962 | \$1000 |
| 50"H x 42"W | HRVG5042GGT | 73.1 | 5.7 | \$1035 | \$1076 |
| 50"H x 48"W | HRVG5048GGT | 83.0 | 6.5 | \$1113 | \$1157 |
| 50"H x 60"W | HRVG5060GGT | 102.8 | 7.9 | \$1199 | \$1247 |
| 50"H x 72"W | HRVG5072GGT | 122.7 | 9.4 | \$1292 | \$1344 |
| T-Connections, Accepts Glass | | | | | |
|  35"H x 18"W | HRVG3518GGTG | 23.6 | 2.0 | \$803 | \$833 |
| 35"H x 36"W | HRVG3536GGTG | 44.3 | 3.6 | \$988 | \$1027 |
| 35"H x 42"W | HRVG3542GGTG | 51.1 | 4.1 | \$1057 | \$1099 |
| 35"H x 48"W | HRVG3548GGTG | 58.0 | 4.7 | \$1131 | \$1176 |
| 35"H x 60"W | HRVG3560GGTG | 71.8 | 5.7 | \$1212 | \$1261 |
| 35"H x 72"W | HRVG3572GGTG | 85.5 | 6.8 | \$1299 | \$1352 |
| | | | | | |
| 42"H x 18"W | HRVG4218GGTG | 28.5 | 2.4 | \$820 | \$851 |
| 42"H x 36"W | HRVG4236GGTG | 53.7 | 4.3 | \$1016 | \$1056 |
| 42"H x 42"W | HRVG4242GGTG | 62.1 | 4.9 | \$1093 | \$1136 |
| 42"H x 48"W | HRVG4248GGTG | 70.5 | 5.6 | \$1178 | \$1225 |
| 42"H x 60"W | HRVG4260GGTG | 87.3 | 6.8 | \$1263 | \$1314 |
| 42"H x 72"W | HRVG4272GGTG | 104.1 | 8.1 | \$1366 | \$1422 |
| | | | | | |
| 50"H x 18"W | HRVG5018GGTG | 33.4 | 2.8 | \$860 | \$893 |
| 50"H x 36"W | HRVG5036GGTG | 63.1 | 5.0 | \$1070 | \$1112 |
| 50"H x 42"W | HRVG5042GGTG | 73.1 | 5.7 | \$1153 | \$1199 |
| 50"H x 48"W | HRVG5048GGTG | 83.0 | 6.5 | \$1242 | \$1292 |
| 50"H x 60"W | HRVG5060GGTG | 102.8 | 7.9 | \$1337 | \$1391 |
| 50"H x 72"W | HRVG5072GGTG | 122.7 | 9.4 | \$1443 | \$1502 |

NOTES:

- Gallery-to-Gallery Panels connect to other Gallery Panels and are available in L-, T-, and Non-symmetrical T-configurations.
- When specifying Gallery-to-Gallery Panels, the installation template (HRVGTGG) is required. The recommendation is one template for every 30 panels. Templates are reusable.
- Gallery-to-Gallery Panels must be of equal or lower height than the Standard Gallery Panel attached. The Gallery-to-Gallery Panel cannot be taller than the adjacent panel. If this is needed, please reach out to Tailored Solutions for a custom solution.
- Made of 1½" board with HPL laminate.
- Can be specified with matching or contrasting edge.
- Edgeband is 2mm ABS.
- Available in woodgrain and solid laminates.
- Non-symmetrical T-panels vary in size on either side of the adjacent panel.
- Woodgrain laminates can be specified with vertical grain up to 48"W. Horizontal grain is available on all sizes.
- Gallery-to-Gallery Panel widths are available in 18", 24", 30", 36", 42", 48", and 60"W.
- Gallery Panels offer 2½" leveling capability.
- Overall heights line up with adjacent panel.
- Gallery-to-Gallery Panels cap over Standard Gallery Panels and are oversized by 1/8" to maintain true interior dimensions.
- Available with or without the integrated glass option.
- Glass specified separately, see 7½"H Gallery Glass on page 472.
- Gallery Panels for use with glass have separate model numbers.
- Gallery-to-Gallery Panels are secured with an inset flat bracket under a painted metal cover.

HOW TO SPECIFY

| | | | | | |
|----------------------------|------------------------|--------------------|--|---------------------------|---------------------|
| Select Model Number | Select Laminate | Select Edge | Select Grain Direction | Select Paint Color | Select Glide |
| See page 423 | See page 423 | See page 423 | VLG Horizontal Grain and Solid Laminate only VST Vertical Grain | See page 423 | G Glide |
| HRVG4242GGT | H | H | VLG | P8T | G |

ABOUND® Gallery-to-Gallery Connections

OPEN MARKET



Icon Legend on page 19

WORKSTATIONS

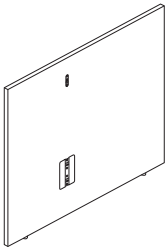

| DESCRIPTION | MODEL | SHIP WEIGHT | CUBE | LIST PRICE BY LAMINATE GRADE | |
|------------------------------------|----------------|-------------|------|------------------------------|--------|
| | | | | L1 | L2 |
| Non-Symmetrical Connections | | | | | |
| 35"H x 18"W/24"W | HRVG351824GGNS | 51.1 | 4.1 | \$921 | \$957 |
| 35"H x 24"W/18"W | HRVG352418GGNS | 51.1 | 4.1 | \$921 | \$957 |
| 35"H x 18"W/30"W | HRVG351830GGNS | 58.0 | 4.7 | \$984 | \$1023 |
| 35"H x 30"W/18"W | HRVG353018GGNS | 58.0 | 4.7 | \$984 | \$1023 |
| 35"H x 24"W/30"W | HRVG352430GGNS | 64.9 | 5.2 | \$1019 | \$1059 |
| 35"H x 30"W/24"W | HRVG353024GGNS | 64.9 | 5.2 | \$1019 | \$1059 |
| 42"H x 18"W/24"W | HRVG421824GGNS | 62.1 | 4.9 | \$964 | \$1002 |
| 42"H x 24"W/18"W | HRVG422418GGNS | 62.1 | 4.9 | \$964 | \$1002 |
| 42"H x 18"W/30"W | HRVG421830GGNS | 70.5 | 5.6 | \$1038 | \$1079 |
| 42"H x 30"W/18"W | HRVG423018GGNS | 70.5 | 5.6 | \$1038 | \$1079 |
| 42"H x 24"W/30"W | HRVG422430GGNS | 78.9 | 6.2 | \$1074 | \$1117 |
| 42"H x 30"W/24"W | HRVG423024GGNS | 78.9 | 6.2 | \$1074 | \$1117 |
| 50"H x 18"W/24"W | HRVG501824GGNS | 73.1 | 5.7 | \$1035 | \$1076 |
| 50"H x 24"W/18"W | HRVG502418GGNS | 73.1 | 5.7 | \$1035 | \$1076 |
| 50"H x 18"W/30"W | HRVG501830GGNS | 83.0 | 6.5 | \$1113 | \$1157 |
| 50"H x 30"W/18"W | HRVG503018GGNS | 83.0 | 6.5 | \$1113 | \$1157 |
| 50"H x 24"W/30"W | HRVG502430GGNS | 92.9 | 7.2 | \$1157 | \$1203 |
| 50"H x 30"W/24"W | HRVG503024GGNS | 92.9 | 7.2 | \$1157 | \$1203 |

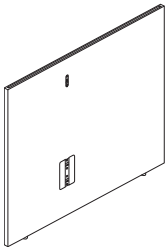

| DESCRIPTION | MODEL | SHIP WEIGHT | CUBE | LIST PRICE BY LAMINATE GRADE | |
|---|-----------------|-------------|------|------------------------------|--------|
| | | | | L1 | L2 |
| Non-Symmetrical Connections, Accepts Glass | | | | | |
| 35"H x 18"W/24"W | HRVG351824GGNSG | 51.1 | 4.1 | \$1057 | \$1099 |
| 35"H x 24"W/18"W | HRVG352418GGNSG | 51.1 | 4.1 | \$1057 | \$1099 |
| 35"H x 18"W/30"W | HRVG351830GGNSG | 58.0 | 4.7 | \$1131 | \$1176 |
| 35"H x 30"W/18"W | HRVG353018GGNSG | 58.0 | 4.7 | \$1131 | \$1176 |
| 35"H x 24"W/30"W | HRVG352430GGNSG | 64.9 | 5.2 | \$1173 | \$1220 |
| 35"H x 30"W/24"W | HRVG353024GGNSG | 64.9 | 5.2 | \$1173 | \$1220 |
| 42"H x 18"W/24"W | HRVG421824GGNSG | 62.1 | 4.9 | \$1093 | \$1136 |
| 42"H x 24"W/18"W | HRVG422418GGNSG | 62.1 | 4.9 | \$1093 | \$1136 |
| 42"H x 18"W/30"W | HRVG421830GGNSG | 70.5 | 5.6 | \$1178 | \$1225 |
| 42"H x 30"W/18"W | HRVG423018GGNSG | 70.5 | 5.6 | \$1178 | \$1225 |
| 42"H x 24"W/30"W | HRVG422430GGNSG | 78.9 | 6.2 | \$1219 | \$1268 |
| 42"H x 30"W/24"W | HRVG423024GGNSG | 78.9 | 6.2 | \$1219 | \$1268 |
| 50"H x 18"W/24"W | HRVG501824GGNSG | 73.1 | 5.7 | \$1153 | \$1199 |
| 50"H x 24"W/18"W | HRVG502418GGNSG | 73.1 | 5.7 | \$1153 | \$1199 |
| 50"H x 18"W/30"W | HRVG501830GGNSG | 83.0 | 6.5 | \$1242 | \$1292 |
| 50"H x 30"W/18"W | HRVG503018GGNSG | 83.0 | 6.5 | \$1242 | \$1292 |
| 50"H x 24"W/30"W | HRVG502430GGNSG | 92.9 | 7.2 | \$1290 | \$1342 |
| 50"H x 30"W/24"W | HRVG503024GGNSG | 92.9 | 7.2 | \$1290 | \$1342 |

NOTES:

- Gallery-to-Gallery Panels connect to other Gallery Panels and are available in L-, T-, and Non-symmetrical T-configurations.
- When specifying Gallery-to-Gallery Panels, the installation template (HRVGTGG) is required. The recommendation is one template for every 30 panels. Templates are reusable.
- Gallery-to-Gallery Panels must be of equal or lower height than the Standard Gallery Panel attached. The Gallery-to-Gallery Panel cannot be taller than the adjacent panel. If this is needed, please reach out to Tailored Solutions for a custom solution.
- Made of 1½" board with HPL laminate.
- Can be specified with matching or contrasting edge.
- Edgeband is 2mm ABS.
- Available in woodgrain and solid laminates.
- Non-symmetric T-panels vary in size on either side of the adjacent panel.
- Woodgrain laminates can be specified with vertical grain up to 48"W. Horizontal grain is available on all sizes.
- Gallery-to-Gallery Panel widths are available in 18", 24", 30", 36", 50", 48", and 60"W.
- Gallery Panels offer 2½" leveling capability.
- Overall heights line up with adjacent panel.
- Gallery-to-Gallery Panels cap over Standard Gallery Panels and are oversized by 1½" to maintain true interior dimensions.
- Available with or without the integrated glass option.
- Glass specified separately, see 7½"H Gallery Glass on page 472.
- Gallery Panels for use with glass have separate model numbers.
- Gallery-to-Gallery Panels are secured with an inset flat bracket under a painted metal cover.

HOW TO SPECIFY

| | | | | | |
|----------------------------|--|------------------------------------|---|---|--------------------------------|
| Select Model Number | Select Laminate See page 423 | Select Edge See page 423 | Select Grain Direction VLG Horizontal Grain and Solid Laminate only VST Vertical Grain | Select Paint Color See page 423 | Select Glide G Glide |
| HRVG421830GGNS | H | H | VLG | P8T | G |



Height Adjustable Tie-In Brackets

| | DESCRIPTION | MODEL | SHIP WEIGHT | CUBE | LIST PRICE BY PAINT GRADE | | |
|--|--|-----------------|--------------------|-------------|---------------------------|-------|-------|
| | | | | | P1 | P2 | P3 |
| | Rectangle Leg, T-Foot Brackets HAT to Panel, Left Hand | HHALRETL | 4.0 | 0.2 | \$162 | \$177 | \$185 |
| | HAT to Panel, Right Hand | HHALRETR | 4.0 | 0.2 | \$162 | \$177 | \$185 |
| | HAT to Gallery Panel | HHALRETG | 3.5 | 0.2 | \$162 | \$177 | \$185 |
| | Rectangle Leg, C-Foot Brackets HAT to Panel, Left Hand | HHALRECL | 4.0 | 0.2 | \$162 | \$177 | \$185 |
| | HAT to Panel, Right Hand | HHALRECR | 4.0 | 0.2 | \$162 | \$177 | \$185 |
| | HAT to Gallery Panel ⓘ Not compatible with Coordinate™ model HHABETA2S2L. | HHALRECG | 3.5 | 0.2 | \$162 | \$177 | \$185 |
| | DESCRIPTION | MODEL | SHIP WEIGHT | CUBE | LIST PRICE | | |
| | Gallery-to-Gallery Template | HRVGTGG | 1.1 | 0.5 | \$63 | | |
| | HAT-to-Gallery Template | HHALGPT | 1.1 | 0.1 | \$49 | | |

NOTES:

- Tie-in brackets are used to tie a height adjustable table to either a Standard Panel or Gallery Panel for added rigidity.
- Bracket ties into the approach side of the height adjustable workstation — this removes the need for a wing panel.
- Can be used as a value engineering option to replace wing panels.
- Available in all paint colors to match panel trim or coordinating colors to the height adjustable base.
- Brackets telescope to account for 24" and 30" deep worksurfaces and screen attachments.

ⓘ Brackets must be used on a return panel, not a spine wall, except if stations are back-to-back on a spine wall and a tie-in bracket is used at a minimum every 96".

ⓘ C-legs with a 30"D worksurface and a screen must be specified with T-leg brackets.

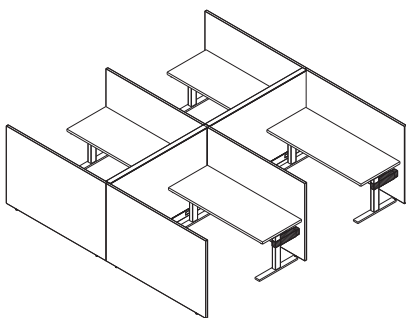

SINGLE BRACKET

Systems Application

- Max Height (with Glass): 65"H
- Max Width: 96"; tops greater than 72"W **will not align.**

Gallery Panel Application

- Max Height (with Glass): 65"H
- Max Width: 75"; no top size restrictions.

DUAL-SIDED PANEL BENCH

Systems Application

- Max Height (with Glass): 65"H
- Bracket needed every 96" on both sides; tops greater than 72"W **will not align.**

Gallery Panel Application

- Max Height (with Glass): 65"H
- Bracket Needed: Single Panel (75") with brackets on each leg (same height).

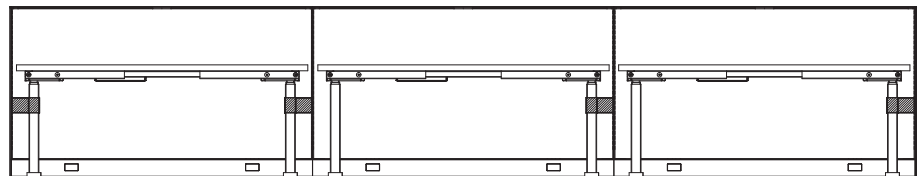

ⓘ Overhead storage cannot be used without return panels.

HOW TO SPECIFY

| | |
|--|---|
| <p>Select Model Number</p> <p>HHALRECL .</p> | <p>Select Paint Color</p> <p>See page 423</p> <p>DW</p> |
|--|---|

ACCELERATE®

Want to see more? Scan here
to check out hon.com.



WORKSTATIONS



Accelerate® 120° Degree Workstations
shown with Contain® and Voi®.

ACCELERATE®

Today's office moves at the speed of light. And that means you need a sensible, streamlined workflow that can adapt to any employee, project, or space. Accelerate workstations are designed with meaningful connection, peak productivity, and seamless adaptability in mind. Whether it's operating as a stand-alone or in a large, open space, Accelerate optimizes any environment with easy-to-configure layout options, exceptional storage capabilities, and stunning customization choices.



FEATURES

- Customize your spaces! Add fabric stackers for height and privacy, or glass stackers to let the light in.
- Accelerate's crisp details have been designed to meet today's contemporary aesthetic. Clean. Minimal. Beautiful.
- Accelerate panels are compatible with other HON products, like Abode™ desks, Contain® storage and more.
- The interchangeable components allow you to customize your space with a clean, contemporary look — and change your mind without changing your furniture.

ACCELERATE® ORDERING INFORMATION

WORKSURFACES, COUNTERTOPS, CORNER SHELVES W/EDGE BAND

L1 LAMINATES CODES

Woodgrain

| | |
|--------------------|------|
| ◆ Bourbon Cherry | H |
| ◆ Cognac | COGN |
| ◆ Florence Walnut | LFW1 |
| ◆ Harvest | C |
| ◆ Kingswood Walnut | LK11 |
| ◆ Mahogany | N |
| ◆ Mocha | MOCH |
| ◆ Natural Maple | D |
| ◆ Pinnacle | PINC |
| ◆ Shaker Cherry | F |
| ◆ Sterling Ash | LSA1 |

Solid

| | |
|------------------|------|
| ◆ Black | P |
| ◆ Charcoal | S |
| ◆ Designer White | LDW1 |
| ◆ Loft | LOFT |

Patterned

| | |
|---------------------|------|
| ◆ Handspun Chestnut | LAHC |
| ◆ Handspun Dove | LAHD |
| ◆ Handspun Pearl | LAHP |
| ◆ Handspun Slate | LAHS |
| ◆ Sheer Mesh * | A5 |
| ◆ Silver Mesh | B9 |
| ◆ Steel Mesh * | A9 |
| ◆ Canyon Zephyr * | K9 |
| ◆ Desert Zephyr * | K8 |
| ◆ Shadow Zephyr * | K1 |
| ◆ Gray | G2 |
| ◆ Grey Tigris * | L6 |
| ◆ White | G1 |
| ◆ Whitestone * | K4 |

L2 LAMINATES CODES

Woodgrain

| | |
|------------------|------|
| ◆ Lowell Ash | LLA1 |
| ◆ Natural Recon | LNR1 |
| ◆ Phantom Ecru | LPE1 |
| ◆ Portico Teak | LPT1 |
| ◆ Skyline Walnut | LSW1 |

(Door panels not available in L2)

WORKSURFACE EDGE BAND

| | |
|--------------------|------|
| ◆ Black | P |
| ◆ Bourbon Cherry | H |
| ◆ Brownstone | EY |
| ◆ Charcoal | S |
| ◆ Cognac | COGN |
| ◆ Designer White | DW |
| ◆ Florence Walnut | FW |
| ◆ Fossil | EH |
| ◆ Greige | R |
| ◆ Harvest | C |
| ◆ Kingswood Walnut | KI |
| ◆ Light Gray | Q |
| ◆ Loft | LOFT |
| ◆ Lowell Ash | DL |
| ◆ Mahogany | N |
| ◆ Mocha | MOCH |
| ◆ Muslin | T |
| ◆ Natural Maple | D |
| ◆ Natural Recon | NR |
| ◆ Phantom Ecru | PE |
| ◆ Pinnacle | PINC |
| ◆ Platinum | K |
| ◆ Portico Teak | DP |
| ◆ Shadow * | SHDW |
| ◆ Shaker Cherry | F |
| ◆ Skyline Walnut | SW |
| ◆ Sterling Ash | SA |

WORKSURFACE GROMMET

| | |
|---------------------|------|
| ◆ Black | P |
| ◆ Brownstone | EY |
| ◆ Charcoal | S |
| ◆ Fossil | EH |
| ◆ Greige | T5 |
| ◆ Light Gray | Q |
| ◆ Loft | LOFT |
| ◆ Muslin | T3 |
| ◆ Shadow * | SHDW |
| ◆ Titanium | T1 |
| ◆ Designer White | DW |
| ◆ Platinum Metallic | T1 |

FRAMES, TRIM, METAL TILES, CUSTOM BRACKET KIT, WORKSURFACE SUPPORTS, STEEL OVERHEAD STORAGE CHASSIS

PAINT CODES

P1

| | |
|------------------|------|
| ◆ Black | P |
| ◆ Brownstone | P7D |
| ◆ Charcoal | S |
| ◆ Designer White | PJW |
| ◆ Fossil | P28 |
| ◆ Greige | T5 |
| ◆ Light Gray | Q |
| ◆ Loft | LOFT |
| ◆ Muslin | T3 |
| ◆ Putty | L |
| ◆ Shadow * | SHDW |
| ◆ Titanium | P8T |

P2

| | |
|----------------------|-----|
| ◆ Champagne Metallic | T4 |
| ◆ Platinum Metallic | T1 |
| ◆ Silver | PR6 |
| ◆ Solar Black | P8X |

DUPLEX/PORTED TILE

PLASTIC CODES

| | |
|------------------|------|
| ◆ Black | P |
| ◆ Brownstone | P7D |
| ◆ Charcoal | S |
| ◆ Designer White | DW |
| ◆ Loft | LOFT |
| ◆ Muslin | T3 |
| ◆ Titanium | TI |

Recommendations

| Paint | Duplex-Data Code |
|-----------------------|-------------------|
| Black P | Black P |
| Brownstone P7D | Brownstone EY |
| Charcoal S | Charcoal S |
| Designer White PJW | Designer White DW |
| Fossil P28 | Charcoal S |
| Greige T5 | Muslin T3 |
| Light Gray Q | Loft LOFT |
| Loft LOFT | Loft LOFT |
| Muslin T3 | Muslin T3 |
| Putty L | Black P |
| Shadow SHDW | Muslin T3 |
| Silver PR6 | Titanium T1 |
| Titanium P8T | Titanium T1 |
| Champagne Metallic T4 | Muslin T3 |
| Platinum Metallic T1 | Titanium T1 |

► LAMINATE TOPS

SPECIFY: Model Number.
Laminate.
Edge Color.
Grommet Color

EXAMPLE: HWR2424P.K8.R.T5

► PANELS

SPECIFY: Model Number.
Fabric
Paint

EXAMPLE: HETP3520FP.APN11.S

► CONNECTORS

SPECIFY: Model Number.
Paint

EXAMPLE: HEC35PS.T3

◆◆◆ For lead time information see page 19.

* De-emphasized

Replacement Duplex Receptacle Covers are made from a polymer material and are available in the following colors only:

| | |
|--------|------|
| Black | P |
| Muslin | T3 |
| Shadow | SHDW |

ACCELERATE[®] FABRIC PATTERNS & CODES

PRICE CODE AA

| FACTOR | FACT |
|-----------|--------|
| ◆ Bark | FACT20 |
| ◆ Barley | FACT15 |
| ◆ Cascade | FACT25 |
| ◆ Feather | FACT30 |

PRICE CODE A

| APPOINT | APN |
|---------------|-------|
| ◆ Artichoke | APN11 |
| ◆ Blackberry | APN32 |
| ◆ Bronze | APN22 |
| ◆ Carbon | APN28 |
| ◆ Chai | APN12 |
| ◆ Cherry | APN30 |
| ◆ Dark Pewter | APN17 |
| ◆ Dune | APN15 |
| ◆ Espresso | APN23 |
| ◆ Framboise | APN31 |
| ◆ Frost | APN34 |
| ◆ Jet | APN27 |
| ◆ Lawn | APN25 |
| ◆ Mandarin | APN29 |
| ◆ Morel | APN09 |
| ◆ Nimbus | APN16 |
| ◆ Platinum | APN24 |
| ◆ Turquoise | APN26 |

CENTURION CU

| | |
|-------------|------|
| ◆ Apricot | CU47 |
| ◆ Bark | CU25 |
| ◆ Black | CU10 |
| ◆ Espresso | CU49 |
| ◆ Fog | CU03 |
| ◆ Frost | CU22 |
| ◆ Goldenrod | CU27 |
| ◆ Indigo | CU06 |
| ◆ Iris | CU50 |
| ◆ Iron Ore | CU19 |
| ◆ Jade | CU83 |
| ◆ Marsala | CU63 |
| ◆ Morel | CU24 |
| ◆ Navy | CU98 |
| ◆ Peacock | CU97 |
| ◆ Pear | CU84 |
| ◆ Ruby | CU67 |
| ◆ Sapphire | CU09 |

PRICE CODE A *continued*

| ETCH* | ECH |
|-------------|-------|
| ◆ Axis | ECH13 |
| ◆ Blend | ECH14 |
| ◆ Cast | ECH12 |
| ◆ Highlight | ECH10 |
| ◆ Midtone | ECH11 |
| ◆ Outline | ECH08 |
| ◆ Shade | ECH09 |
| ◆ Tonal | ECH16 |
| ◆ Vanish | ECH15 |

EXCHANGE* EXG

| | |
|-------------|--------|
| ◆ Iron | EXG916 |
| ◆ Nickel | EXG914 |
| ◆ Pistachio | EXG910 |
| ◆ Root | EXG913 |
| ◆ Rupee | EXG903 |
| ◆ Shadow | EXG911 |
| ◆ Silver | EXG915 |
| ◆ Sisal | EXG917 |
| ◆ Stone | EXG912 |

LANDSCAPE* LN

| | |
|------------|------|
| ◆ Azure | LN55 |
| ◆ Cornsilk | LN15 |
| ◆ Drift | LN05 |
| ◆ Khaki | LN20 |
| ◆ Sheen | LN10 |
| ◆ Slate | LN35 |
| ◆ Umber | LN25 |
| ◆ Urban | LN30 |

LUCY* LC

| | |
|------------|------|
| ◆ Aspen | LC32 |
| ◆ Cornsilk | LC30 |
| ◆ Dusk | LC22 |
| ◆ Fawn | LC33 |
| ◆ Graphite | LC34 |
| ◆ Mist | LC20 |
| ◆ Neutra | LC24 |
| ◆ Pewter | LC35 |
| ◆ Snowdrop | LC28 |

PRICE CODE A *continued*

| REFLECTIONS* | REF |
|--------------|-------|
| ◆ Galvanized | REF29 |
| ◆ Ice | REF20 |
| ◆ Loggia | REF21 |
| ◆ Mistral | REF28 |
| ◆ Moonstone | REF23 |
| ◆ Pewter | REF22 |
| ◆ Stainless | REF24 |
| ◆ Vanilla | REF25 |
| ◆ Winter | REF27 |

REFUGE* RFG

| | |
|------------|-------|
| ◆ Artesian | RFG96 |
| ◆ Dune | RFG92 |
| ◆ Eclipse | RFG90 |
| ◆ Frost | RFG93 |
| ◆ Glacier | RFG91 |
| ◆ Mineral | RFG98 |
| ◆ Tidal | RFG94 |

SARTO* SRT

| | |
|--------------|-------|
| ◆ Ash | SRT88 |
| ◆ Fog | SRT14 |
| ◆ Lemongrass | SRT49 |
| ◆ Mist | SRT45 |
| ◆ Mushroom | SRT76 |
| ◆ Oyster | SRT18 |
| ◆ Reef | SRT64 |
| ◆ Sesame | SRT93 |
| ◆ Shale | SRT52 |

TEMPEST* TP

| | |
|---------------|------|
| ◆ Dragonfly | TP30 |
| ◆ Frost | TP15 |
| ◆ Full Stream | TP80 |
| ◆ Gold Rush | TP10 |
| ◆ Slate | TP45 |
| ◆ Tumbleweed | TP70 |
| ◆ Wind Chill | TP40 |
| ◆ Zebra | TP35 |

NOTES: Centurion fabric not available on panels that exceed a width and height of 54".

Analog, Disperse, and Exchange panel fabrics will be applied pattern cut. Disperse will not be available on 72"W panels.

◆◆◆ For lead time information see page 19.

* Directional fabrics

ACCELERATE® FABRIC PATTERNS & CODES

| PRICE CODE B | | PRICE CODE B <i>continued</i> | | PRICE CODE B <i>continued</i> | | PRICE CODE B <i>continued</i> | |
|----------------|--------|-------------------------------|--------|-------------------------------|--------|-------------------------------|--------|
| DISPERSE* | DISP | MICA* | MCA | SPIN* | SPIN | TERRAIN* | TRRN |
| ◆ Autumn | DISP03 | ◆ Anthracite | MCA11 | ◆ Alabaster | SPIN02 | ◆ Bay | TRRN05 |
| ◆ Branch | DISP10 | ◆ Breeze | MCA18 | ◆ Cavern | SPIN03 | ◆ Bayou | TRRN35 |
| ◆ Coffee Bean | DISP13 | ◆ Bronze | MCA13 | ◆ Cobblestone | SPIN04 | ◆ Canyon | TRRN30 |
| ◆ Dusk | DISP09 | ◆ Buff | MCA14 | ◆ Ember | SPIN06 | ◆ Cliff | TRRN45 |
| ◆ Emerald City | DISP08 | ◆ Cremini | MCA17 | ◆ Flame | SPIN07 | ◆ Crest | TRRN25 |
| ◆ Gold Rush | DISP02 | ◆ Crystal | MCAWIT | ◆ Heron | SPIN13 | ◆ Delta | TRRN10 |
| ◆ Igloo | DISP11 | ◆ Dew | MCA20 | ◆ Oat | SPIN01 | ◆ Plateau | TRRN15 |
| ◆ Ink | DISP06 | ◆ Dove | MCA12 | ◆ Ocean | SPIN12 | ◆ Ridge | TRRN20 |
| ◆ Mist | DISP12 | ◆ Fresh | MCA16 | ◆ Plum | SPIN15 | ◆ Valley | TRRN40 |
| ◆ Oatmeal | DISP15 | ◆ Mineral | MCA15 | ◆ Pool | SPIN11 | | |
| ◆ Prince | DISP07 | ◆ Nectar | MCA19 | ◆ Raven | SPIN10 | | |
| ◆ Reservoir | DISP01 | ◆ Shale | MCA10 | ◆ Rhubarb | SPIN14 | | |
| ◆ Rose | DISP04 | | | ◆ Tropic | SPIN08 | | |
| ◆ Spring | DISP05 | | | ◆ Willow | SPIN05 | | |
| ◆ Steel | DISP16 | | | | | | |
| ◆ Taupe | DISP14 | | | | | | |

NOTES: Disperse and Exchange panel fabrics will be applied pattern cut. Disperse will not be available on 72"W panels.

◆◆◆ For lead time information see page 19.
* Directional fabrics

ACCELERATE® Typicals



Icon Legend on page 19

WORKSTATIONS

| QTY | DESCRIPTION | MODEL | FABRIC GRADE | LIST PRICE | PRICE EXTENSION |
|-----|--|-------------|--------------|------------|-----------------|
| 2 | Accelerate® Top Cap 72"W | HETC72 | | \$114 | \$228 |
| 2 | Tackable Panel 50"H x 72"W | HETP5072FP | | \$643 | \$1,286 |
| 1 | "L" Connector 50"H | HEC50PLN | | \$144 | \$144 |
| 1 | "L" Connector Strap | HECSL | | \$17 | \$17 |
| 2 | Panel Finished End Covers 50"H | HEFEC50P | | \$65 | \$130 |
| 2 | Electrical Power Harness Panels w/Duplex Capacity | HH871272 | | \$239 | \$478 |
| 1 | Duplex Receptacle Circuit 1 3-1 & 2-2 | HH871501 | | \$47 | \$47 |
| 1 | Duplex Receptacle Circuit 4 3-1 & 2-2 | HH871504 | | \$47 | \$47 |
| 1 | Base In-Feed Cable Base 3-1 & 2-2 | HH879072 | | \$253 | \$253 |
| 1 | Rectangular Worksurface 24"D x 48"W | HWR2448P | | \$446 | \$446 |
| 1 | Rectangular Worksurface 24"D x 72"W | HWR2472P | | \$583 | \$583 |
| 1 | 24"D Cantilever - One Pair | HCTL242 | | \$93 | \$93 |
| 1 | Flat Bracket 24"D | HHN831124 | | \$72 | \$72 |
| 1 | External Stiffener 48"W | HLSSL25C60 | | \$106 | \$106 |
| 1 | Flagship® Series Freestanding Pedestal "A" Pull B/B 15"W x 22½"D x 28"H | H19723A | | \$837 | \$837 |
| 1 | Flagship® Series Freestanding Pedestal "A" Pull F/F 15"W x 22½"D x 28"H | H19823A | | \$837 | \$837 |
| 1 | Pedestal-to-Panel Bracket, Left | HPD2PNBRK2L | | \$122 | \$122 |
| 1 | Pedestal-to-Panel Bracket, Right | HPD2PNBRK2R | | \$122 | \$122 |
| 1 | Lota® Mid-Back Chair | H2281 | 1 | \$828 | \$828 |

TOTAL: \$6,676

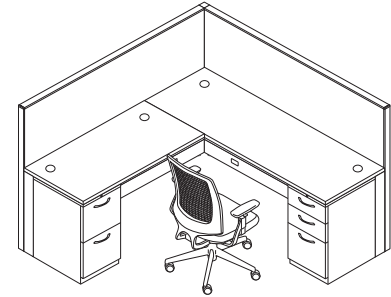

| QTY | DESCRIPTION | MODEL | FABRIC GRADE | LIST PRICE | PRICE EXTENSION |
|-----|--|-------------|--------------|------------|-----------------|
| 2 | Tackable Top-Tier Glass Panel 50"H x 20"W | HETP5020DP | | \$561 | \$1,122 |
| 2 | Tackable Top-Tier Glass Panel 50"H x 42"W | HETP5042DP | | \$665 | \$1,330 |
| 5 | Tackable Panel 65"H x 24"W | HETP6524FP | | \$395 | \$1,975 |
| 2 | Tackable Panel 65"H x 48"W | HETP6548FP | | \$506 | \$1,012 |
| 2 | Accelerate® Top Cap 72"W | HETC72 | | \$114 | \$228 |
| 3 | Accelerate® Top Cap 24"W | HETC24 | | \$42 | \$126 |
| 2 | Accelerate® Top Cap 20"W | HETC20 | | \$42 | \$84 |
| 2 | Accelerate® Top Cap 42"W | HETC42 | | \$68 | \$136 |
| 4 | Worksurface Bracket Kits | HWSB2 | | \$52 | \$208 |
| 2 | Flat Bracket 24"D | HHN831124 | | \$72 | \$144 |
| 2 | Straight Connector Kits | HSCKTPS | | \$22 | \$44 |
| 2 | "L" Connector 50"H | HEC50PLN | | \$144 | \$288 |
| 2 | "L" Connector 65"H | HEC65PLN | | \$161 | \$322 |
| 1 | "T" Connector 65"H | HEC65PTN | | \$155 | \$155 |
| 4 | "L" Connector Strap | HECSL | | \$17 | \$68 |
| 1 | "T" Connector Strap | HECST | | \$24 | \$24 |
| 2 | Panel Finished End Covers 50"H | HEFEC50P | | \$65 | \$130 |
| 1 | Panel Finished End Covers 65"H | HEFEC65P | | \$73 | \$73 |
| 2 | In-line Variable Height Finishing Kit 15"W | HEVHF15P | | \$64 | \$128 |
| 2 | Electrical Power Harness 3-1 & 2-2 48"W | HH871248 | | \$239 | \$478 |
| 1 | Electrical Pass-Thru w/o Power Block 3-1 & 2-2 48"W | HH871048 | | \$137 | \$137 |
| 1 | Base In-Feed Cable Base 3-1 & 2-2 | HH879072 | | \$253 | \$253 |
| 1 | Duplex Receptacle Circuit 1 3-1 & 2-2 | HH871501 | | \$47 | \$47 |
| 1 | Duplex Receptacle Circuit 2 3-1 & 2-2 | HH871502 | | \$47 | \$47 |
| 1 | Duplex Receptacle Circuit 4 3-1 & 2-2 | HH871504 | | \$47 | \$47 |
| 1 | Duplex Receptacle Circuit 1 3-1 & 2-2 | HH871506 | | \$47 | \$47 |
| 2 | Rectangular Worksurface 18"D x 42"W | HWR1842P | | \$366 | \$732 |
| 2 | Rectangular Worksurface 24"D x 48"W | HWR2448P | | \$446 | \$892 |
| 2 | Worksurface to Tower Bracket Kits | HSTB2W1 | | \$88 | \$176 |
| 2 | Stack-on Storage w/Sliding Doors 14¼"D x 48"W x 13"H | HLSSL1448S | | \$1,208 | \$2,416 |
| 2 | Voi® for Systems Stack-on Storage Panel Mounted Bracket | HLSLPMB | | \$145 | \$290 |
| 2 | Voi® Mobile Pedestal 15¾"W x 21½"D x 21½"H | HLSL2016MP2 | 1 | \$893 | \$1,786 |
| 2 | Voi® Pedestal Cushion | HLSL2016PH2 | 2 | \$371 | \$742 |
| 1 | Voi® Personal Storage Tower (LH) 24"D x 24"W x 65"H | HLSLW446LP | | \$2,920 | \$2,920 |
| 1 | Voi® Personal Storage Tower (RH) 24"D x 24"W x 65"H | HLSLW446RP | | \$2,920 | \$2,920 |
| 2 | Nucleus® 4-Way Stretch Back Work Chair | HNI | 1 | \$932 | \$1,864 |

TOTAL: \$23,391

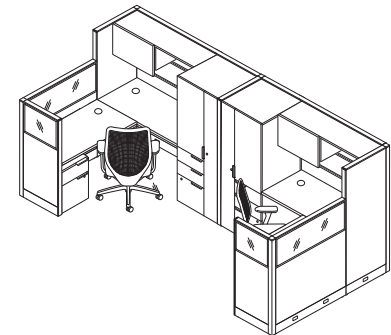



Icon Legend on page 19

ACCELERATE® Typicals

WORKSTATIONS

| QTY | DESCRIPTION | MODEL | FABRIC GRADE | LIST PRICE | PRICE EXTENSION |
|-----|--|------------|--------------|---------------|-----------------|
| 1 | In-Line Connector | HSCKTPS | | \$22 | \$22 |
| 2 | Tackable Panel 42½"H x 24"W | HETP4224FP | | \$326 | \$652 |
| 2 | Tackable Panel 42½"H x 60"W | HETP4260FP | | \$457 | \$914 |
| 2 | Accelerate® Top Cap 60"W | HETC60 | | \$94 | \$188 |
| 2 | Accelerate® Top Cap 24"W | HETC24 | | \$42 | \$84 |
| 4 | Accelerate® Countertop Kit | HECB42 | | \$60 | \$240 |
| 2 | Worksurface Bracket Kit | HWSB2 | | \$52 | \$104 |
| 1 | Universal Support Leg 24"D | HRVCLG24 | | \$218 | \$218 |
| 2 | "L" Connector 42½"H | HEC42PLN | | \$125 | \$250 |
| 2 | "L" Connector Strap | HECSL | | \$17 | \$34 |
| 1 | "T" Connector Strap | HECST | | \$24 | \$24 |
| 2 | Panel Finished End Covers 42½"H | HEFEC42P | | \$61 | \$122 |
| 1 | Base In-Feed Cable Base 3-1 & 2-2 | HH879072 | | \$253 | \$253 |
| 1 | Electrical Pass-Thru Cable w/Duplex For 24"W Panel | HH871124 | | \$143 | \$143 |
| 2 | Electrical Power Harness 3-1 & 2-2 60"W | HH871260 | | \$239 | \$478 |
| 2 | Duplex Receptacle Circuit 4 3-1 & 2-2 | HH871504 | | \$47 | \$94 |
| 2 | Rectangular Worksurface 24"D x 60"W | HWR2460P | | \$526 | \$1,052 |
| 2 | Straight Countertop 60"W x 15"D | HBCSR1560P | | \$417 | \$834 |
| 2 | Flagship® Mobile Series Pedestal "A" Pull B/B/F 15"W x 22½"D x 28"H | H18723A | | \$851 | \$1,702 |
| 2 | Ignition® Mid-Back Work Chair | HIWM3 | 1 | \$850 | \$1,700 |
| | | | | TOTAL: | \$9,108 |



| QTY | DESCRIPTION | MODEL | FABRIC GRADE | LIST PRICE | PRICE EXTENSION |
|-----|--|-------------|--------------|---------------|-----------------|
| 3 | Systems Corner Worksurface w/ 120° Curve Edge 42"W x 24"D | HBWCT4224P | | \$917 | \$2,751 |
| 3 | Systems 60° Wedge Worksurface Edgeband 24"W x 24"D | HCWQT2424P | | \$433 | \$1,299 |
| 3 | 120° 2-way Connector 35"H | HEC35P2N | | \$99 | \$297 |
| 3 | 120° 2-way Connector Strap | HECSV | | \$24 | \$72 |
| 2 | Panel Finished End Covers 35"H | HEFEC35P | | \$57 | \$114 |
| 4 | Frameless Glass 15"H x 42"W | HEFGS1542 | | \$613 | \$2,452 |
| 4 | Tackable Panel 35"H x 42"W | HETP3542FP | | \$350 | \$1,400 |
| 4 | Electrical Power Harness 3-1 & 2-2 Systems 42"W | HH871242 | | \$239 | \$956 |
| 1 | Duplex Receptacle Circuit 1 3-1 & 2-2 Systems | HH871501 | | \$47 | \$47 |
| 2 | Duplex Receptacle Circuit 2 3-1 & 2-2 Systems | HH871502 | | \$47 | \$94 |
| 2 | Duplex Receptacle Circuit 3 3-1 System Only | HH871503 | | \$47 | \$94 |
| 3 | Duplex Receptacle Circuit 4 3-1 & 2-2 Systems | HH871504 | | \$47 | \$141 |
| 1 | Base In-Feed Cable Base 3-1 & 2-2 Systems | HH879072 | | \$253 | \$253 |
| 3 | Mobile Pedestal 20"W x 15¼"D x 21½"H | HLSL2016MP2 | | \$893 | \$2,679 |
| 3 | Pedestal Cushion 20"W x 15¼"D x 1"H | HLSL2016PH2 | 2 | \$371 | \$1,113 |
| 2 | Abound® Left End Panel 29"H x 24"D | HRVEP2429L | | \$246 | \$492 |
| 2 | Abound® Right End Panel 29"H x 24"D | HRVEP2429R | | \$246 | \$492 |
| 2 | Systems Rectangular Worksurface Edgeband 24"D x 42"W | HWR2442P | | \$419 | \$838 |
| 6 | Universal Support Leg 24"D | HRVCLG24 | | \$218 | \$1,308 |
| | | | | TOTAL: | \$16,892 |

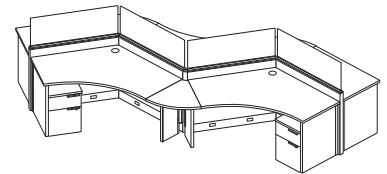

ACCELERATE® PANELS OVERVIEW

INTERSECTING CONNECTIONS

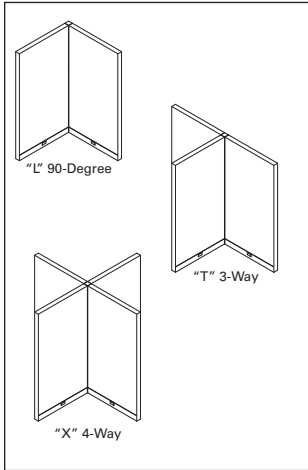

“L”, “T” and “X” connector kits are used when connecting frames at intersecting runs. For “L”, “T” and “X” connector kits, add 2¼” to the total length of the panel run for each intersection, whether located in the middle or at the end of the run.

Wall starter kits provide a means to affix a panel run to a permanent building wall. Kit adds ⅞” to length of panel run.

STACKING PANELS

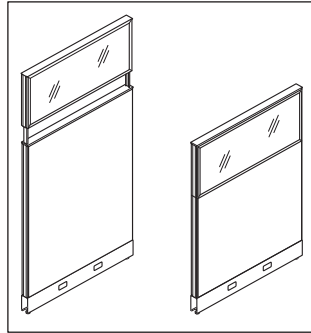

Stackers add 15” to the height of the base panel and can be ordered separately or as part of the panel model, see pages 491 and 494.

When adding stackers to an existing panel, a new connector must be ordered, to the tallest panel height.

Please note that Stacking Panels are not to be used freestanding and must match the panel width of the panel it is stacking on.

Cannot use a stacking panel on a Top Tier Glass Panel model.

Stackers ship with pins to connect stacker to post connector for added rigidity.

Stackers can be stacked up to 80”H on a base panel. Overheads can be placed on the first stacker only, up to 65”H. Voi overheads are not to be placed on stackers.

| | | |
|----------|---------|-------|
| Top View | | |
| Panel | | Panel |
| | ← 2¼" → | |
| Panel | S | Panel |

Extended straight connector kit “S” can be used to keep continuous runs dimensionally consistent with opposing panel runs which incorporate “T” or “X” intersections. (Add 2¼” to the length of the run for every extended straight connector used.)

IN-LINE CONNECTIONS

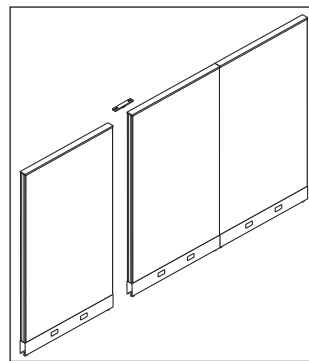

There is no incremental increase in dimension along the panel run when using an in-line connector kit.

END OF RUN

Finished end trim must be specified for the unconnected sides of panel. When adding a stacking panel, order finished end trim in the height that matches the total stacked height. Move the end cap from the standard frame end trim to the stacking frame end trim.

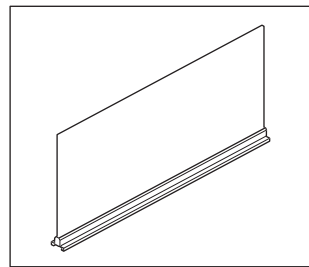

Accelerate® frameless glass is single pane, ⅜” thick laminate safety glass, available in clear or frosted glass.

Frameless glass is not allowed on top of glass stackers or glass header panels and hanging or stacking on frameless glass is not permitted.

Frameless glass can span multiple panels with one piece of glass, creating a clean, seamless look.

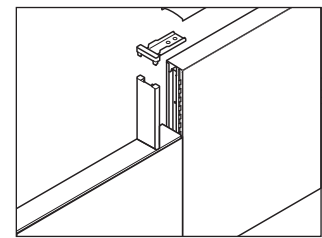

IN-LINE VARIABLE HEIGHT TRIM
In-line connections between different height panels require trim to cover the exposed frame of the taller panel.

VARIABLE HEIGHT CONNECTOR TRIM

L, X and T connections between different height panels require trim to cover the exposed connector. The bottom of the trim is flat to match the profile of the top cap. Models are designated as “Variable Height Connector Trim”. For variable height connections in a Y configuration, contact the Accelerate Specials Department.

Multiple-height connections are accomplished by combining standard height panel connectors (35”H, 42”H, 50”H and 65”H) with shorter trim kits (7”H, 15”H, 22”H and 30”H). Start from the top-down — select the standard connector that corresponds to the height and connection type of the tallest panel. (See examples.)

ACCELERATE® PANELS OVERVIEW

Example 1

Connectors required:
1-50"H "T" Connector
2-15"H Connector VH Kit
2-35"H End Trim
1-65"H End Trim

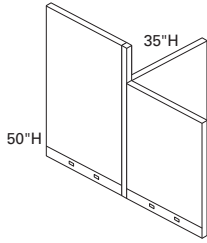

In variable height "T" connections — as shown above — you would use the connectors as indicated.

Example 2

Connectors required:
1-50"H "X" Connector
2-7½"H Connector VH Kit
2-50"H End Trim
2-42"H End Trim

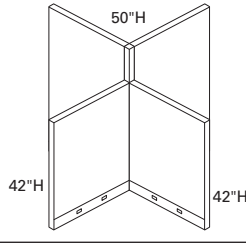

Example 3

Connectors required:
1-65"H "T" Connector
1-15"H Connector VH Kit
1-22½"H Connector VH Kit
1-65"H End Trim
1-50"H End Trim
1-42"H End Trim

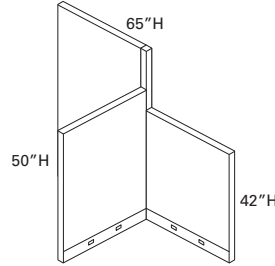

Example above represents Accelerate variable height "L" for 65" to 50".

TOP CAPS

Top caps must be specified as a separate model from the panel. Top caps can span more than one panel when panels are connected in an in-line.

ACCELERATE® WORKING WITH PANELS

PANELS

- Accelerate® Panels are 2½” thick and available in 4 heights / 8 widths.

NOTE: Actual panel height varies depending on position of levelers.

| NOMINAL PANEL HEIGHT | PANEL WIDTHS | | | | | | | |
|-------------------------|--------------|-----|-----|-----|-----|-----|-----|-----|
| | 20" | 24" | 30" | 36" | 42" | 48" | 60" | 72" |
| 35" | 20" | 24" | 30" | 36" | 42" | 48" | 60" | 72" |
| 42½" | 20" | 24" | 30" | 36" | 42" | 48" | 60" | 72" |
| 50" | 20" | 24" | 30" | 36" | 42" | 48" | 60" | 72" |
| 65" | 20" | 24" | 30" | 36" | 42" | 48" | 60" | 72" |

Maximum Receptacle Capacity in Panel Base Pathways

| Widths | 20 | 24 | 30 | 36 | 42 | 48 | 60 | 72 |
|--------------------------------------|-----|----|----|----|----|----|----|----|
| Maximum of 1 duplex per panel side | N/A | X | | | | | | |
| Maximum of 2 duplexes per panel side | N/A | | X | X | X | X | X | X |

The center of the duplex is always 12” from the end of the panel on all Accelerate® panels.

PANEL SPECIFICATION AND INSTALLATION NOTES

Definitions:

Parent Panel Run – Panels (or a single panel) configured in a straight line intended to divide space. It is usually longer than the panels used to stabilize it.

Return Panels – Panels attached to a parent run for the purpose of stabilizing it. Return panels may also have the effect of dividing space.

Note: Return panels must be no more than 30” lower than the maximum height of the parent panel run. When stacking, the maximum height allowed is 80”. This includes frameless glass. If attaching overhead storage, return panels must be the same height as parent run.

Method 1: Opposing Returns

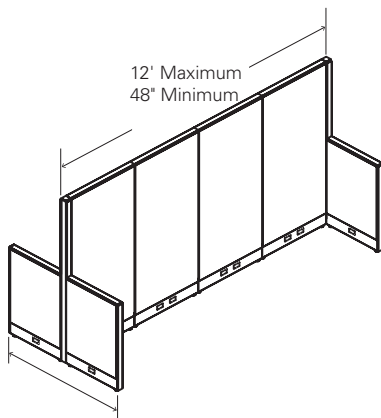

Method 2: Single-Sided

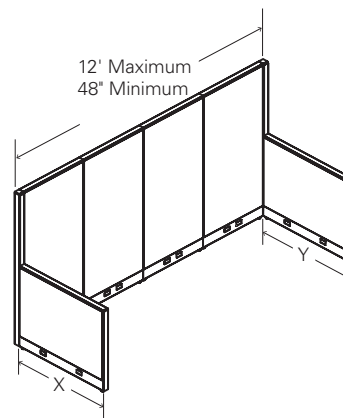

A parent panel run must be a minimum of 4 feet and a maximum of 12 feet, and must have a minimum of two return panels extended in opposing directions on each side of the parent run.

| Panel Run Length | Minimum Return Panels | Minimum Return Panels with Stack-ons |
|------------------|-----------------------|--------------------------------------|
| 48" | 20" | 20" |
| 54" | 20" | 20" |
| 60" | 20" | 20" |
| 66" | 20" | 20" |
| 72" | 20" | 20" |
| 78" | 20" | 20" |
| 84" | 20" | 20" |
| 90" | 20" | 20" |
| 96" | 20" | 20" |
| 102" | 20" | 20" |
| 108" | 24" | 24" |
| 114" | 24" | 24" |
| 120" | 24" | 24" |
| 144" | 24" | 24" |

A parent panel run must be a minimum of 4 feet and a maximum of 12 feet, and must have a minimum of two return panels (X+Y) extended in one direction (one at the beginning and at the end of the parent run) as defined below.

| Panel Run Length | Minimum Return Panels Total (X+Y) | Minimum Return Panels Total (X+Y) with Stack-ons |
|------------------|-----------------------------------|--|
| 48" | 84" | 84" |
| 54" | 84" | 84" |
| 60" | 84" | 84" |
| 66" | 84" | 84" |
| 72" | 84" | 84" |
| 78" | 84" | 84" |
| 84" | 84" | 84" |
| 90" | 84" | 84" |
| 96" | 84" | 84" |
| 102" | 84" | 84" |
| 108" | 84" | 96" |
| 114" | 84" | 96" |
| 120" | 84" | 96" |
| 144" | 84" | 96" |

Design:

- Slots allow hanging worksurfaces and hang-on units, in 1” increments.
- Panels standard with two adjustable leveling glides.
- No panel creep.
- Meets or exceeds ANSI/BIFMA Standards.

Top Tier and Stacking Panels

- Available in tackable fabric as well as clear and frosted glass.
- Select from a full height panel/top tier panels or stackers.
- Stackers can be stacked up to 80”H on a base panel.
- Overheads can be placed on the first stacker only, up to 65”H. Voi overheads are not to be placed on stackers.

ACCELERATE® CONNECTOR OVERVIEW

CONNECTOR KITS — ACCELERATE®

| | |
|------------|---|
| TPS | In-line Connector |
| PSN | Extended Straight Connector |
| PLN | “L” Connector |
| PTN | “T” Connector |
| PXN | “X” Connector |
| P2N | 120° 2-way Connector |
| P3N | 120° 3-way Connector |
| CV | Connector Variable Height Finishing Kit |
| VH | In-line Variable Height Finishing Kit |

ADDITIONAL MODELS FOR USE WITH CONNECTOR KITS

| | |
|-----------|---------------------|
| FE | Finished End Covers |
| WS | Wall Starter Kit |
| WT | Wall Track |

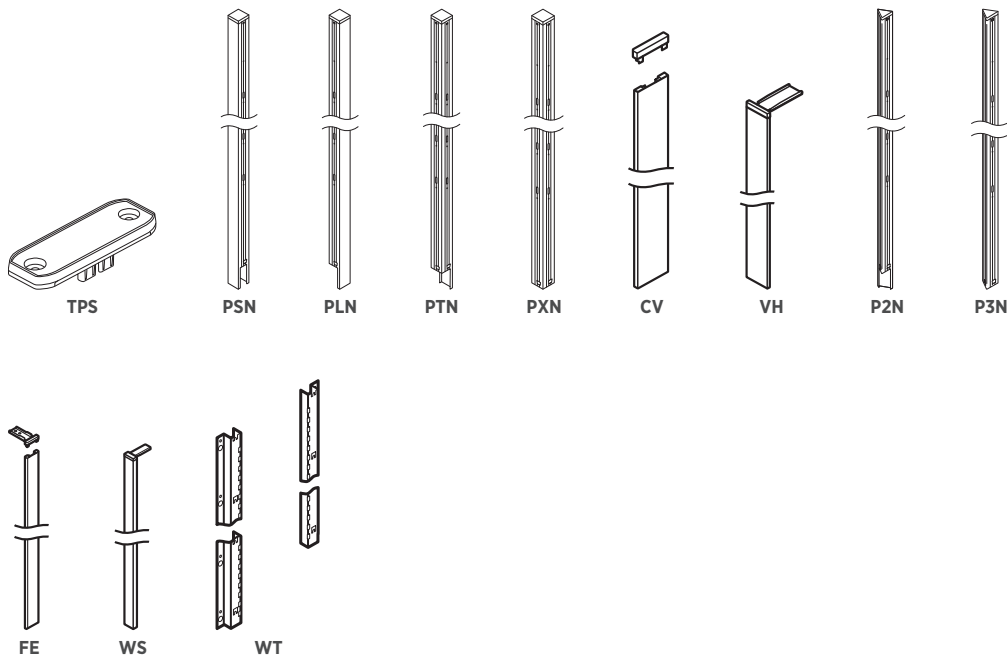

Panel-to-Panel Connector

- Attaches same height, panel-to-panel in a straight run with screws.
- Ensures alignment on panels in a straight run.

Wall Starter Kit (see page 499)

- Anchor devices are not supplied with the wall starter kit. Refer to Accelerate® Installation Instructions for appropriate hardware.
- Adds 7/8" to length of run.

ACCELERATE® Tackable Raceway Panels

GSA SIN 33721



Icon Legend on page 19

WORKSTATIONS

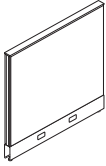

DESCRIPTION

35" H Tackable Acoustical Panels

35" H x 20" W
35" H x 24" W
35" H x 30" W
35" H x 36" W
35" H x 42" W
35" H x 48" W
35" H x 60" W
35" H x 72" W*

MODEL

SHIP WEIGHT

CUBE

CORE LIST PRICE BY CODE

AA

A

B

| | | | | | |
|------------|----|-----|-------|-------|-------|
| HETP3520FP | 13 | 1.0 | \$296 | \$307 | \$326 |
| HETP3524FP | 14 | 1.2 | \$308 | \$319 | \$361 |
| HETP3530FP | 16 | 1.5 | \$322 | \$335 | \$380 |
| HETP3536FP | 18 | 1.8 | \$345 | \$359 | \$406 |
| HETP3542FP | 20 | 2.1 | \$350 | \$365 | \$418 |
| HETP3548FP | 23 | 2.4 | \$368 | \$384 | \$439 |
| HETP3560FP | 27 | 3.0 | \$400 | \$418 | \$483 |
| HETP3572FP | 33 | 3.6 | \$560 | \$579 | \$652 |

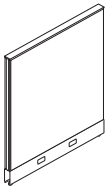

42 1/2" H Tackable Acoustical Panels

42 1/2" H x 20" W
42 1/2" H x 24" W
42 1/2" H x 30" W
42 1/2" H x 36" W
42 1/2" H x 42" W
42 1/2" H x 48" W
42 1/2" H x 60" W
42 1/2" H x 72" W*

| | | | | | |
|------------|----|-----|-------|-------|-------|
| HETP4220FP | 14 | 1.2 | \$312 | \$325 | \$357 |
| HETP4224FP | 16 | 1.5 | \$326 | \$339 | \$371 |
| HETP4230FP | 18 | 1.8 | \$345 | \$357 | \$396 |
| HETP4236FP | 20 | 2.2 | \$363 | \$377 | \$419 |
| HETP4242FP | 23 | 2.6 | \$395 | \$411 | \$460 |
| HETP4248FP | 25 | 3.0 | \$410 | \$428 | \$487 |
| HETP4260FP | 30 | 3.7 | \$457 | \$476 | \$545 |
| HETP4272FP | 36 | 4.4 | \$589 | \$611 | \$690 |

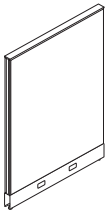

50" H Tackable Acoustical Panels

50" H x 20" W
50" H x 24" W
50" H x 30" W
50" H x 36" W
50" H x 42" W
50" H x 48" W
50" H x 60" W
50" H x 72" W*

| | | | | | |
|------------|----|-----|-------|-------|-------|
| HETP5020FP | 16 | 1.4 | \$358 | \$373 | \$436 |
| HETP5024FP | 17 | 1.7 | \$371 | \$386 | \$449 |
| HETP5030FP | 20 | 2.2 | \$382 | \$398 | \$442 |
| HETP5036FP | 22 | 2.6 | \$394 | \$410 | \$460 |
| HETP5042FP | 25 | 3.0 | \$441 | \$459 | \$517 |
| HETP5048FP | 28 | 3.5 | \$467 | \$487 | \$552 |
| HETP5060FP | 32 | 4.3 | \$509 | \$530 | \$604 |
| HETP5072FP | 38 | 5.2 | \$643 | \$666 | \$752 |

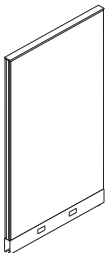

65" H Tackable Acoustical Panels

65" H x 20" W
65" H x 24" W
65" H x 30" W
65" H x 36" W
65" H x 42" W
65" H x 48" W
65" H x 60" W
65" H x 72" W*

| | | | | | |
|------------|----|-----|-------|-------|-------|
| HETP6520FP | 19 | 1.9 | \$381 | \$396 | \$444 |
| HETP6524FP | 20 | 2.3 | \$395 | \$410 | \$458 |
| HETP6530FP | 23 | 2.8 | \$416 | \$432 | \$483 |
| HETP6536FP | 26 | 3.4 | \$446 | \$464 | \$522 |
| HETP6542FP | 29 | 3.9 | \$485 | \$504 | \$569 |
| HETP6548FP | 32 | 4.5 | \$506 | \$526 | \$599 |
| HETP6560FP | 37 | 5.6 | \$540 | \$560 | \$642 |
| HETP6572FP | 43 | 6.8 | \$731 | \$754 | \$846 |

NOTES:

- Panels are 2 1/8" thick.
- Baserails ship standard with panels.
- Top caps ordered separately; see page 493.
- Packaging: stretch wrapped with edge protection.
- Base rail matches trim color.
- For worksurfaces that can be used with Abound® and Accelerate® systems, see pages 617-629.
- Panel end trim ordered separately; see page 499.
- Panels may be connected end to end, with wall starter kit, or with panel connectors; see pages 497-499.
- Order Accelerate® connectors separately; see page 497.
- Panels have a class A fire rating.
- Bulk packing is available in quantities of 3 or 9.
- Fabrics and finishes available on pages 481-483.

- ! Raceway panels option only.
- ! Do not remove electrical knockouts unless duplex is needed. For replacement covers, see page 610.
- ! Accepts electrical power kits, except for 20"W. See page 608 for electrical.
- ! Stack on panels add 15" of height and can be added to any monolithic panel. See stackers on pages 494-495.
- ! Disperse and Analog fabrics are not available on 72"W panels.
- ! If adding to existing panels produced prior to 04/13/16, please contact Customer Support for compatibility.
- ! If a third cutout for data is desired, order the separate kickplate model HEBPLATE.
- ! Panels should not be used in unsupported applications or take the place of permanent walls. Panels are intended to be supported with floor supports and/or storage or tied in with worksurfaces. Refer to Specifying and Design Guide pages.

HOW TO SPECIFY

Select Model Number

HETP3520FP

Select Fabric

See pages 482-483

APN15

Select Trim Color

See page 481

P1 Paint (no upcharge)
P2 Paint (\$30 upcharge)

S



Icon Legend on page 19

ACCELERATE® Top-Tier Glass Panels

WORKSTATIONS

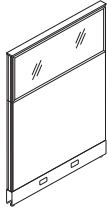

DESCRIPTION

50" H Tackable Panels — Top-Tier Glass

- 50" H x 20" W
- 50" H x 24" W
- 50" H x 30" W
- 50" H x 36" W
- 50" H x 42" W
- 50" H x 48" W
- 50" H x 60" W
- 50" H x 72" W*

| MODEL | SHIP WEIGHT | CUBE | CORE LIST PRICE BY CODE | | |
|------------|-------------|------|-------------------------|--------|--------|
| | | | AA | A | B |
| HETP5020DP | 21 Ⓢ | 1.4 | \$561 | \$581 | \$644 |
| HETP5024DP | 23 Ⓢ | 1.7 | \$585 | \$605 | \$668 |
| HETP5030DP | 27 Ⓢ | 2.2 | \$596 | \$618 | \$662 |
| HETP5036DP | 31 Ⓢ | 2.6 | \$608 | \$630 | \$680 |
| HETP5042DP | 34 Ⓢ | 3.0 | \$665 | \$689 | \$747 |
| HETP5048DP | 39 Ⓢ | 3.5 | \$694 | \$721 | \$786 |
| HETP5060DP | 46 | 4.3 | \$748 | \$778 | \$853 |
| HETP5072DP | 55 | 5.2 | \$997 | \$1030 | \$1115 |

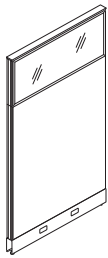

65" H Tackable Panels — Top-Tier Glass

- 65" H x 20" W
- 65" H x 24" W
- 65" H x 30" W
- 65" H x 36" W
- 65" H x 42" W
- 65" H x 48" W
- 65" H x 60" W
- 65" H x 72" W*

| | | | | | |
|------------|------|-----|--------|--------|--------|
| HETP6520DP | 24 Ⓢ | 1.9 | \$588 | \$609 | \$657 |
| HETP6524DP | 27 Ⓢ | 2.3 | \$605 | \$626 | \$674 |
| HETP6530DP | 30 Ⓢ | 2.8 | \$626 | \$648 | \$699 |
| HETP6536DP | 34 Ⓢ | 3.4 | \$661 | \$685 | \$743 |
| HETP6542DP | 39 Ⓢ | 3.9 | \$709 | \$735 | \$800 |
| HETP6548DP | 43 Ⓢ | 4.5 | \$733 | \$760 | \$833 |
| HETP6560DP | 51 | 5.6 | \$765 | \$795 | \$879 |
| HETP6572DP | 60 | 6.8 | \$1088 | \$1121 | \$1213 |

NOTES:

- On top-tier panel models, the glass tier is 15" H.
- Glass is clear or frosted, tempered safety glass.
- Panels are 2 1/8" thick.
- Panels have steel baserails.
- Packaging: stretch wrapped with edge protection.
- Base rail matches trim color.
- Top caps ordered separately; see page 493.
- For worksurfaces that can be used with Abound® and Accelerate® systems, see pages 617-629.
- Panel end trim ordered separately; see page 499.
- Panels may be connected end to end, with wall starter kit, or with panel connectors; see pages 497-499.
- Order Accelerate® connectors separately; see page 497.
- Panels have a class A fire rating.
- Bulk packing is available in quantities of 3 or 9.
- Fabrics and finishes available on pages 481-483.

- ⓘ Raceway panels option only.
- ⓘ Do not remove electrical knockouts unless duplex is needed. For replacement covers, see page 610.
- ⓘ Accepts electrical power kits, except for 20" W. See page 608 for electrical.
- ⓘ Cannot stack stacker on top-tier glass panels.
- ⓘ Disperse and Analog fabrics are not available on 72" W panels.
- ⓘ If adding to existing panels produced prior to 04/13/16, please contact Customer Support for compatibility.
- ⓘ If a third cutout for data is desired, order the separate kickplate model HEBPLATE.
- ⓘ Panels should not be used in unsupported applications or take the place of permanent walls. Panels are intended to be supported with floor supports and/or storage or tied in with worksurfaces. Refer to Specifying and Design Guide pages.

HOW TO SPECIFY

| | | | |
|-----------------------------------|--|---|--|
| <p>Select Model Number</p> | <p>Select Fabric</p> <p>See pages 482-483</p> | <p>Select Trim Color</p> <p>See page 481</p> <p>P1 Paint (no upcharge)</p> <p>P2 Paint (\$30 upcharge)</p> | <p>Select Glass</p> <p>Q Clear Glass</p> <p>R Frosted Glass (\$30 upcharge)</p> |
| HETP5020DP | APN15 | S | Q |

ACCELERATE® Panel Door

GSA SIN 33721



Icon Legend on page 19

WORKSTATIONS

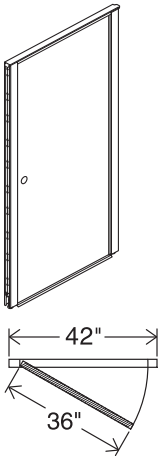

| DESCRIPTION | MODEL | SHIP WEIGHT | CUBE | LIST PRICE BY PAINT GRADE | |
|-------------|-------|-------------|------|---------------------------|----|
| | | | | P1 | P2 |

| | | | | | |
|---|------------------|-------|-----|---------------|---------------|
| Door Panel — Laminate 42"W x 80"H | HEPDMK42P | 155.0 | 7.3 | \$2123 | \$2156 |
|---|------------------|-------|-----|---------------|---------------|

NOTES: Ships with door, frame, hinges and hardware. Best placement of a door is at an L, T, X connector or wall starter connector for rigidity. Use of spanning top caps at an in-line will also help add additional rigidity.

❗ Must be used with a base panel and stacker equaling 80"H.

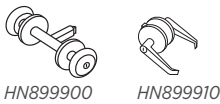

HN899900 HN899910

Standard Lock Set

Door knob (polished brass)
Door lever (brushed aluminum)

| | | | |
|-----------------|-------|-----|--------------|
| HN899900 | 2.0 ☹ | 0.1 | \$126 |
| HN899910 | 2.0 ☹ | 0.1 | \$347 |

NOTES: Door knob and lever are both keyed on one side.



Abound® and Accelerate® Sliding Door

50"H x 42"W
65"H x 42"W
80"H x 42"W

| | | | | |
|------------------|------|-----|---------------|---------------|
| HH15042SD | 28.0 | 5.5 | \$2266 | \$2302 |
| HH16542SD | 38.0 | 7.1 | \$2583 | \$2619 |
| HH18042SD | 46.0 | 8.6 | \$3160 | \$3196 |

❗ Door is only available in Frosted Translucent Acrylic. Specify paint for frame.

❗ Can only install Sliding Door at the end of a run, not at a corner.

❗ A Mounting Bracket Kit must be ordered for each sliding door corresponding to the mounting panels width (30", 36", 42", or 48"W).



Accelerate® Mounting Kit for Sliding Door

For 30"W Panel
For 36"W Panel
For 42"W Panel
For 48"W Panel

| | | | | |
|-----------------|-----|-----|--------------|--------------|
| HESDMK30 | 4.0 | 0.4 | \$189 | \$201 |
| HESDMK36 | 5.0 | 0.5 | \$199 | \$211 |
| HESDMK42 | 6.0 | 0.5 | \$207 | \$219 |
| HESDMK48 | 7.0 | 0.5 | \$217 | \$229 |

NOTES: Specify paint.



Carpet Grippers

NOTES: Used with Glide Towers
Shipped 12 per package
No need to specify paint

| | | | |
|---------------|-------|-----|-------------|
| HICG12 | 0.5 ☹ | 0.1 | \$23 |
|---------------|-------|-----|-------------|



Coat Hooks

Package of six

| | | | |
|---------------|-------|-----|-------------|
| HHPMC6 | 1.0 ☹ | 0.2 | \$94 |
|---------------|-------|-----|-------------|

NOTES: Compatible with Accelerate® and Abound® panels.

❗ Black only.

NOTES:

- Order handle separately. See handle model options above.
- Specify top caps separately when ordering the laminate panel door; see page 493.
- Order Accelerate® connectors separately; see page 497.
- Fabrics and finishes available on pages 481-483.
- The Sliding Doors are available in 50", 65", and 80"H models and can mount to 30", 36", 42", and 48"W panels.
- All doors are 42" wide, provide a 36"W opening, and are non-handed.

HOW TO SPECIFY

| | | |
|---|---|---|
| Select Model Number H E P D M K 4 2 P . | Select Trim Color See page 481 T 4 . | Select Door Laminate L2 Laminate Upcharge \$60 See page 481 H |
|---|---|---|



ACCELERATE® Top Caps

| DESCRIPTION | MODEL | SHIP WEIGHT | CUBE | LIST PRICE BY PAINT GRADE | |
|----------------------|--------|-------------|------|---------------------------|-------|
| | | | | P1 | P2 |
| Panel Top Cap | | | | | |
| 20"W | HETC20 | 1.5 | 0.3 | \$42 | \$62 |
| 24"W | HETC24 | 1.6 | 0.3 | \$42 | \$62 |
| 30"W | HETC30 | 1.8 | 0.3 | \$51 | \$71 |
| 36"W | HETC36 | 2.0 | 0.3 | \$65 | \$85 |
| 42"W | HETC42 | 2.2 | 0.3 | \$68 | \$88 |
| 48"W | HETC48 | 3.4 | 0.4 | \$76 | \$96 |
| 60"W | HETC60 | 3.9 | 0.6 | \$94 | \$114 |
| 66"W | HETC66 | 4.0 | 0.6 | \$110 | \$130 |
| 72"W | HETC72 | 5.3 | 0.8 | \$114 | \$134 |
| 78"W | HETC78 | 6.5 | 0.8 | \$119 | \$139 |
| 84"W | HETC84 | 6.7 | 0.9 | \$130 | \$150 |
| 90"W | HETC90 | 7.0 | 0.9 | \$136 | \$156 |
| 96"W | HETC96 | 7.2 | 0.9 | \$143 | \$163 |

NOTES:

- Models above are specified for panel models on pages 490-491.
 - Top caps ship separately from panels.
 - Top caps are able to span multiple panels for a clean aesthetic.
 - Top caps are bulk packed for ease at installation sites.
- ! If adding to existing panels produced prior to 04/13/16, please contact Customer Support for compatibility.

HOW TO SPECIFY

| | |
|----------------------------|---------------------------|
| Select Model Number | Select Paint Color |
| HE T C 2 0 . | T 3 |

| DESCRIPTION | MODEL | SHIP WEIGHT | CUBE | LIST PRICE BY PAINT GRADE | |
|---|-------------|-------------|------|---------------------------|-------|
| | | | | P1 | P2 |
| Accelerate® Base Pathway Cover w/Additional Knockout | | | | | |
| 36"W | HEBPLATE336 | 7 | 0.4 | \$82 | \$92 |
| 42"W | HEBPLATE342 | 8 | 0.4 | \$84 | \$94 |
| 48"W | HEBPLATE348 | 9 | 0.4 | \$88 | \$98 |
| 60"W | HEBPLATE360 | 11 | 0.5 | \$100 | \$110 |
| 72"W | HEBPLATE372 | 14 | 0.6 | \$111 | \$121 |

NOTES: Specify paint, see page 481.
SPECIFYING EXAMPLE: HEBPLATE336.T4

NOTES:

- ! Specify Pathways to match trim color.
- ! Standard raceways with two knockouts are standard on panels. If additional three knockout kickplate is ordered, the two port version can be saved or discarded.

HOW TO SPECIFY

| | |
|----------------------------|---------------------------|
| Select Model Number | Select Paint Color |
| HE B P L A T E 3 3 6 . | T 4 |

ACCELERATE® Stacking Panels

GSA SIN 33721



Icon Legend on page 19

WORKSTATIONS



DESCRIPTION

15”H Stacking Panels — Fabric

15”H x 20”W
15”H x 24”W
15”H x 30”W
15”H x 36”W
15”H x 42”W
15”H x 48”W
15”H x 60”W
15”H x 72”W

| MODEL | SHIP WEIGHT | CUBE | CORE LIST PRICE BY CODE | | |
|----------|-------------|------|-------------------------|-------|-------|
| | | | AA | A | B |
| HES1520F | 6 | 0.5 | \$203 | \$224 | \$272 |
| HES1524F | 7 | 0.6 | \$224 | \$245 | \$293 |
| HES1530F | 8 | 0.8 | \$242 | \$264 | \$315 |
| HES1536F | 9 | 0.9 | \$259 | \$283 | \$341 |
| HES1542F | 11 | 1.1 | \$280 | \$306 | \$371 |
| HES1548F | 12 | 1.2 | \$298 | \$325 | \$398 |
| HES1560F | 14 | 1.5 | \$337 | \$367 | \$451 |
| HES1572F | 17 | 1.8 | \$639 | \$672 | \$764 |

NOTES:

- Stacking panels ship without top caps.
- Stackers add 15” or 30” to the height of the base panel.
- Stacker ships with pins to connect stacker to post connector for added rigidity.
- Select complete panels with top-tier glass, or add glass/fabric stackers separately to existing panels. See page 491 for complete panels information.

- Not to be used freestanding.
- Stackers can be stacked up to 80”H on a base panel or 30” of stacker height total, whichever comes first.
- The first stacker on a base panel is weight bearing and can accommodate overhead storage up to 65”H.
- Stacking model must match the width of the panel it is stacking on.
- Total panel height cannot exceed 80” high. Glass stacker must be the top tier. A stacking panel cannot be placed above a glass panel or glass stacker. Frameless Glass can be installed on a fabric stacker.
- Voi overheads not to be placed on stackers.
- If adding to existing panels produced prior to 04/13/16, please contact Customer Support for compatibility.

HOW TO SPECIFY

| | |
|---|--|
| <p>Select Model Number</p> <p>H E S 1 5 2 0 F .</p> | <p>Select Fabric Color</p> <p>See pages 482-483</p> <p>A P N 1 1</p> |
|---|--|



ACCELERATE® Stacking Panels

| | DESCRIPTION | MODEL | SHIP WEIGHT | CUBE | CLEAR GLASS | FROSTED GLASS |
|--|--|--------------------------|-----------------|------|---------------|---------------|
| | 30”H Stacking Panels — Glass | | | | | |
| | 30”H x 20”W | HES3020G | 14 Ⓔ | 1.0 | \$661 | \$691 |
| | 30”H x 24”W | HES3024G | 17 Ⓔ | 1.2 | \$695 | \$725 |
| | 30”H x 30”W | HES3030G | 20 Ⓔ | 1.5 | \$788 | \$818 |
| | 30”H x 36”W | HES3036G | 23 Ⓔ | 1.8 | \$815 | \$845 |
| | 30”H x 42”W | HES3042G | 26 Ⓔ | 2.1 | \$901 | \$931 |
| | 30”H x 48”W | HES3048G | 29 Ⓔ | 2.4 | \$970 | \$1000 |
| | 30”H x 60”W | HES3060G | 36 | 3.0 | \$1112 | \$1142 |
| | NOTES: 30”H stacker ships with pins to connect stacker to post connector for added rigidity. | | | | | |
| | 15”H Stacking Panels — Glass | | | | | |
| | 15”H x 20”W | HES1520G | 8 Ⓔ | 0.5 | \$441 | \$471 |
| | 15”H x 24”W | HES1524G Ⓢ | 9 Ⓔ | 0.6 | \$467 | \$497 |
| | 15”H x 30”W | HES1530G Ⓢ | 11 Ⓔ | 0.8 | \$526 | \$556 |
| | 15”H x 36”W | HES1536G Ⓢ | 12 Ⓔ | 0.9 | \$545 | \$575 |
| | 15”H x 42”W | HES1542G | 14 Ⓔ | 1.1 | \$602 | \$632 |
| | 15”H x 48”W | HES1548G Ⓢ | 16 Ⓔ | 1.2 | \$648 | \$678 |
| | 15”H x 60”W | HES1560G Ⓢ | 19 Ⓔ | 1.5 | \$741 | \$771 |
| | | 15”H x 72”W | HES1572G | 22 | 1.8 | \$903 |

NOTES:

- Stacking panels ship without top caps.
- Stackers add 15” or 30” to the height of the base panel.
- Stacker ships with pins to connect stacker to post connector for added rigidity.
- Select complete panels with top-tier glass, or add glass/fabric stackers separately to existing panels. See page 491 for complete panels information.
- !** Not to be used freestanding.
- !** Stackers can be stacked up to 80”H on a base panel or 30” of stacker height total, whichever comes first.
- !** The first stacker on a base panel is weight bearing and can accommodate overhead storage up to 65”H.
- !** Stacking model must match the width of the panel it is stacking on.
- !** Total panel height cannot exceed 80” high. Glass stacker must be the top tier. A stacking panel cannot be placed above a glass panel or glass stacker. Frameless Glass can be installed on a fabric stacker.
- !** If adding to existing panels produced prior to 04/13/16, please contact Customer Support for compatibility.

HOW TO SPECIFY

| | | |
|---|--|--|
| <p>Select Model Number</p> <p>HES3020G</p> | <p>Select Paint Color</p> <p>See page 481 P1 Paint (no upcharge) P2 Paint (\$30 upcharge)</p> <p>T1</p> | <p>Select Glass</p> <p>Q Clear Glass R Frosted Glass</p> <p>Q</p> |
|---|--|--|

ACCELERATE® Frameless Glass

GSA SIN 33721



Icon Legend on page 19

WORKSTATIONS

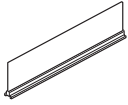

DESCRIPTION

Frameless Glass Stacker

7½"H x 20"W
7½"H x 24"W
7½"H x 30"W
7½"H x 36"W
7½"H x 42"W
7½"H x 48"W
7½"H x 54"W
7½"H x 60"W
7½"H x 66"W
7½"H x 72"W

| MODEL | SHIP WEIGHT | CUBE | CLEAR GLASS | FROSTED GLASS |
|-----------|-------------|------|-------------|---------------|
| HEFGS0720 | 17 | 0.7 | \$347 | \$377 |
| HEFGS0724 | 18 | 0.8 | \$410 | \$447 |
| HEFGS0730 | 18 | 1.0 | \$441 | \$482 |
| HEFGS0736 | 21 | 1.2 | \$507 | \$554 |
| HEFGS0742 | 25 | 1.5 | \$541 | \$591 |
| HEFGS0748 | 28 | 1.5 | \$582 | \$636 |
| HEFGS0754 | 28 | 1.7 | \$656 | \$717 |
| HEFGS0760 | 35 | 1.8 | \$712 | \$778 |
| HEFGS0766 | 35 | 2.0 | \$793 | \$865 |
| HEFGS0772 | 42 | 2.2 | \$842 | \$920 |

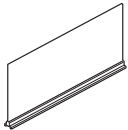

Frameless Glass Stacker

15"H x 20"W
15"H x 24"W
15"H x 30"W
15"H x 36"W
15"H x 42"W
15"H x 48"W
15"H x 54"W
15"H x 60"W
15"H x 66"W
15"H x 72"W

| | | | | |
|-----------|----|-----|-------|--------|
| HEFGS1520 | 27 | 1.2 | \$430 | \$460 |
| HEFGS1524 | 28 | 1.4 | \$466 | \$503 |
| HEFGS1530 | 28 | 1.7 | \$498 | \$539 |
| HEFGS1536 | 34 | 2.0 | \$571 | \$618 |
| HEFGS1542 | 39 | 2.3 | \$613 | \$663 |
| HEFGS1548 | 45 | 2.6 | \$661 | \$715 |
| HEFGS1554 | 51 | 2.7 | \$723 | \$784 |
| HEFGS1560 | 57 | 3.0 | \$806 | \$872 |
| HEFGS1566 | 62 | 3.3 | \$880 | \$952 |
| HEFGS1572 | 67 | 3.6 | \$950 | \$1028 |



DESCRIPTION

Frameless Glass Finishing Kit

7½"H
15"H

| MODEL | SHIP WEIGHT | CUBE | LIST PRICE BY PAINT GRADE | |
|----------|-------------|------|---------------------------|------|
| | | | P1 | P2 |
| HEVHG07P | 2 | 0.2 | \$60 | \$69 |
| HEVHG15P | 2 | 0.4 | \$64 | \$73 |

NOTES: Specify paint, see page 483.

SPECIFYING EXAMPLE: HEVHG15P.PJW

NOTES:

- Glass is a single-pane, 3/8" laminated safety glass.
- Available in clear or frosted glass.
- Frameless Glass can span multiple panels with one piece of glass.
- Lamination is in the center of the glass, making both clear and frosted glass a writable surface with dry-erase markers.
- Glass tiles have a Class A fire rating.

! Frameless Glass cannot be used on top of glass stackers or headers.

! Frameless Glass can only be used on the top of panels. Glass integrates into top cap trim. Do not order a separate top cap model for your frame when using Frameless Glass.

! Cannot hang or stack on top of Frameless Glass.

! If adding to existing panels produced prior to July 2021, please contact Customer Support for compatibility.

HOW TO SPECIFY

| | | |
|---|--|---|
| Select Model Number <div style="border: 1px solid black; padding: 2px; display: flex; gap: 5px;"> HEFGS1520 </div> | Select Paint Color See page 481 P1 Paint (no upcharge) P2 Paint (\$17 upcharge) <div style="border: 1px solid black; padding: 2px; display: flex; gap: 5px;"> T1 </div> | Select Glass Option G Clear Glass R Frosted Glass <div style="border: 1px solid black; padding: 2px; display: flex; gap: 5px;"> G </div> |
|---|--|---|



Icon Legend on page 19

ACCELERATE®

Strengthened Connection Posts

| | DESCRIPTION | MODEL | SHIP | | LIST PRICE BY PAINT GRADE | | |
|--|--|------------|--------|------|---------------------------|-------|-------|
| | | | WEIGHT | CUBE | P1 | P2 | P3 |
| | 120° 2-Way Connector Posts | | | | | | |
| | For 35"H Panels | HEC35P2N | 6 | 0.5 | \$99 | \$108 | \$125 |
| | For 42½"H Panels | HEC42P2N | 6 | 0.5 | \$119 | \$128 | \$145 |
| | For 50"H Panels | HEC50P2N | 7 | 0.6 | \$138 | \$147 | \$164 |
| | For 57½"H Panels | HEC57P2N | 8 | 0.8 | \$148 | \$157 | \$174 |
| | For 65"H Panels | HEC65P2N | 8 | 0.8 | \$155 | \$164 | \$181 |
| | For 72½"H Panels | HEC72P2N | 9 | 0.9 | \$164 | \$173 | \$190 |
| | For 80"H Panels | HEC80P2N | 9 | 0.9 | \$171 | \$180 | \$197 |
| | 120° 3-Way Connector Posts | | | | | | |
| | For 35"H Panels | HEC35P3N | 6 | 0.5 | \$94 | \$103 | \$120 |
| | For 42½"H Panels | HEC42P3N | 6 | 0.5 | \$112 | \$121 | \$138 |
| | For 50"H Panels | HEC50P3N | 7 | 0.6 | \$133 | \$142 | \$159 |
| | For 57½"H Panels | HEC57P3N | 8 | 0.8 | \$141 | \$150 | \$167 |
| | For 65"H Panels | HEC65P3N | 8 | 0.8 | \$149 | \$158 | \$175 |
| | For 72½"H Panels | HEC72P3N | 9 | 0.9 | \$158 | \$167 | \$184 |
| | For 80"H Panels | HEC80P3N | 9 | 0.9 | \$166 | \$175 | \$192 |
| | Extended Straight Connector Posts | | | | | | |
| | For 35"H Panels | HEC35PSN | 6 | 0.5 | \$99 | \$108 | \$125 |
| | For 42½"H Panels | HEC42PSN | 6 | 0.5 | \$119 | \$128 | \$145 |
| | For 50"H Panels | HEC50PSN | 7 | 0.6 | \$138 | \$147 | \$164 |
| | For 57½"H Panels | HEC57PSN | 8 | 0.8 | \$148 | \$157 | \$174 |
| | For 65"H Panels | HEC65PSN | 8 | 0.8 | \$155 | \$164 | \$181 |
| | For 72½"H Panels | HEC72PSN | 9 | 0.9 | \$166 | \$175 | \$192 |
| | For 80"H Panels | HEC80PSN | 9 | 0.9 | \$171 | \$180 | \$197 |
| | "L" Connector Posts | | | | | | |
| | For 35"H Panels | HEC35PLN | 6 | 0.5 | \$104 | \$113 | \$130 |
| | For 42½"H Panels | HEC42PLN ☉ | 6 | 0.5 | \$125 | \$134 | \$151 |
| | For 50"H Panels | HEC50PLN ☉ | 7 | 0.6 | \$144 | \$153 | \$170 |
| | For 57½"H Panels | HEC57PLN ☉ | 8 | 0.8 | \$154 | \$163 | \$180 |
| | For 65"H Panels | HEC65PLN ☉ | 8 | 0.8 | \$161 | \$170 | \$187 |
| | For 72½"H Panels | HEC72PLN | 9 | 0.9 | \$169 | \$178 | \$195 |
| | For 80"H Panels | HEC80PLN | 9 | 0.9 | \$178 | \$187 | \$204 |
| | "T" Connector Posts | | | | | | |
| | For 35"H Panels | HEC35PTN | 6 | 0.5 | \$99 | \$108 | \$125 |
| | For 42½"H Panels | HEC42PTN ☉ | 6 | 0.5 | \$119 | \$128 | \$145 |
| | For 50"H Panels | HEC50PTN ☉ | 7 | 0.6 | \$138 | \$147 | \$164 |
| | For 57½"H Panels | HEC57PTN ☉ | 8 | 0.8 | \$148 | \$157 | \$174 |
| | For 65"H Panels | HEC65PTN ☉ | 8 | 0.8 | \$155 | \$164 | \$181 |
| | For 72½"H Panels | HEC72PTN | 9 | 0.9 | \$164 | \$173 | \$190 |
| | For 80"H Panels | HEC80PTN | 9 | 0.9 | \$171 | \$180 | \$197 |
| | "X" Connector Posts | | | | | | |
| | For 35"H Panels | HEC35PXN | 6 | 0.5 | \$94 | \$103 | \$120 |
| | For 42½"H Panels | HEC42PXN ☉ | 6 | 0.5 | \$112 | \$121 | \$138 |
| | For 50"H Panels | HEC50PXN ☉ | 7 | 0.6 | \$133 | \$142 | \$159 |
| | For 57½"H Panels | HEC57PXN ☉ | 8 | 0.8 | \$141 | \$150 | \$167 |
| | For 65"H Panels | HEC65PXN ☉ | 8 | 0.8 | \$149 | \$158 | \$175 |
| | For 72½"H Panels | HEC72PXN | 9 | 0.9 | \$158 | \$167 | \$184 |
| | For 80"H Panels | HEC80PXN | 9 | 0.9 | \$166 | \$175 | \$192 |

NOTES:

- Specify connectors based on number and placement of panels.
- Connector posts are specified separately from connector straps — specify post to tallest panel and straps based on connection (see variable height example on straps page).
- Specify connector to fit height of tallest panel.
- Connectors are made of extruded aluminum.
- Straight Connector model HSCKTPS ships standard in bulk pack.
- Connector posts where power pole will enter need to be specified with single connector straps, model HECS1.

☉ In-line connector must be specified for all in-line connections.

☉ If adding to existing panels produced prior to 04/13/2016, please contact Customer Support for compatibility.

HOW TO SPECIFY

| | |
|---|--|
| Select Model Number H E C 3 5 P 2 N . | Select Paint Color See page 481 T 3 |
|---|--|

| | DESCRIPTION | MODEL | SHIP WEIGHT | CUBE | LIST PRICE |
|--|---|---------|-------------|------|------------|
| | 120° 2-Way Connector Strap | HECSV | 1.4 | 0.2 | \$24 |
| | 120° 3-Way Connector Strap | HECSY | 2.2 | 0.2 | \$29 |
| | Extended Straight Connector Strap | HECSS | 1.6 | 0.2 | \$24 |
| | "L" Connector Strap | HECSL | 1.5 | 0.2 | \$17 |
| | "T" Connector Strap | HECST | 2.3 | 0.2 | \$24 |
| | "X" Connector Strap | HECSX | 3.0 | 0.2 | \$29 |
| | Single Connector Strap | HECSI | 1.9 | 0.2 | \$17 |
| | In-line Connector NOTES: No need to specify finish. SPECIFYING EXAMPLE: HSCKTPS.X | HSCKTPS | 0.5 | 0.1 | \$22 |

NOTES:

- Strengthened Connection Straps provide more rigidity to panel connections, especially when not tied into a station with a worksurface or storage, i.e., when Coordinate™ Height Adjustable bases are used or when using panels strictly to divide space without tying in other components.
- Connector strap type should be specified based on the tallest panel connection type. Connector straps and posts are specified separately.
- Lower height panels will connect with variable height trim.
- See examples below.
- Connector straps can be retrofitted on any existing Accelerate® stations that were produced from April 2016 to present.
- Will fit on existing connector posts — only straps would need to be specified.
- Single Straps (HECSI) are used when power poles enter at the connector post and in variable height applications where the tallest panel is a single and one or more panels is lower.

Connector Post



New Connector Straps

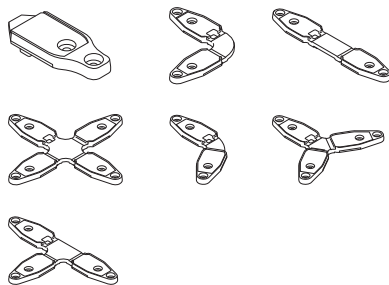

+

"T" 2 High, "L" 1 Low

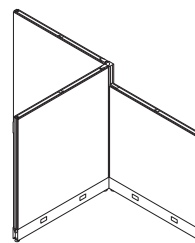

- 1 — "T" Connector Post
- 1 — VH Post Trim
- 3 — Top Caps
- 3 — End Caps
- 1 — "L" Connector Strap

"T" 1 High, "L" 2 Low

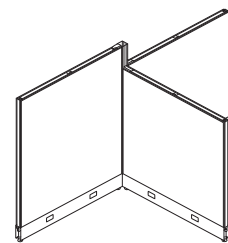

- 1 — "T" Connector Post
- 2 — VH Post Trim
- 3 — Top Caps
- 3 — End Caps
- 1 — Single Connector Strap

HOW TO SPECIFY

Select Model Number



Variable Height Finished End and Wall Starter Kits



| DESCRIPTION | MODEL | SHIP WEIGHT | CUBE | LIST PRICE BY PAINT GRADE | |
|----------------------------|----------|-------------|------|---------------------------|------|
| | | | | P1 | P2 |
| Finished End Covers | | | | | |
| 35"H | HEFEC35P | 3 | 0.4 | \$57 | \$66 |
| 42½"H | HEFEC42P | 3 | 0.5 | \$61 | \$70 |
| 50"H | HEFEC50P | 4 | 0.6 | \$65 | \$74 |
| 57½"H | HEFEC57P | 5 | 0.6 | \$68 | \$77 |
| 65"H | HEFEC65P | 5 | 0.7 | \$73 | \$82 |
| 72½"H | HEFEC72P | 6 | 0.8 | \$78 | \$87 |
| 80"H | HEFEC80P | 6 | 0.9 | \$81 | \$90 |

NOTES: Finished End Covers include top bracket, end trim clips and end trim.



| | | | | | |
|--|----------|---|-----|------|------|
| In-line Variable Height Finishing Kit | | | | | |
| 7½"H | HEVHF07P | 2 | 0.2 | \$60 | \$69 |
| 15"H | HEVHF15P | 2 | 0.4 | \$64 | \$73 |
| 22½"H | HEVHF22P | 3 | 0.4 | \$75 | \$84 |
| 30"H | HEVHF30P | 3 | 0.4 | \$88 | \$97 |

NOTES: In-line Variable Height Finishing Kits include top and bottom bracket, end trim clips and end trim. In-line Variable Height Finishing Kit is used to connect a finished in-line panel connection.



| | | | | | |
|--|----------|---|-----|------|------|
| Connector Variable Height Finishing Kit | | | | | |
| 7½"H | HECVH07P | 2 | 0.2 | \$60 | \$69 |
| 15"H | HECVH15P | 2 | 0.4 | \$64 | \$73 |
| 22½"H | HECVH22P | 3 | 0.4 | \$75 | \$84 |
| 30"H | HECVH30P | 3 | 0.4 | \$88 | \$97 |

NOTES: Connector Variable Height Finishing Kits include top and bottom bracket, end trim and end trim connection piece.



| | | | | | |
|-------------------------|---------|---|-----|-------|-------|
| Wall Starter Kit | | | | | |
| 35"H | HEWS35P | 4 | 0.4 | \$96 | \$105 |
| 42½"H | HEWS42P | 4 | 0.5 | \$101 | \$110 |
| 50"H | HEWS50P | 5 | 0.6 | \$105 | \$114 |
| 57½"H | HEWS57P | 6 | 0.6 | \$111 | \$120 |
| 65"H | HEWS65P | 6 | 0.7 | \$119 | \$128 |
| 72½"H | HEWS72P | 7 | 0.8 | \$127 | \$136 |
| 80"H | HEWS80P | 7 | 0.9 | \$133 | \$142 |

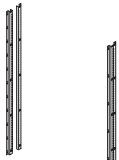

| | | | | | |
|----------------------------------|-----------|---|-----|-------|-------|
| Permanent Wall Hanger Kit | | | | | |
| 2½"W x 7/8"D x 66"H | HRVC35PCE | 6 | 0.7 | \$243 | \$263 |
| 4¼"W x 7/8"D x 66"H | HRVC35PCM | 3 | 0.7 | \$128 | \$138 |

Anchor devices are not supplied with this model. Refer to Abound® Installation instructions for appropriate hardware. Attachment to masonry walls is not recommended.

Specify paint

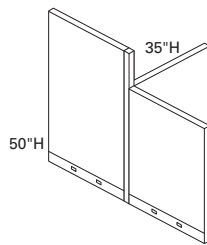

T-Connection Connector, Variable Height Finishing Kit

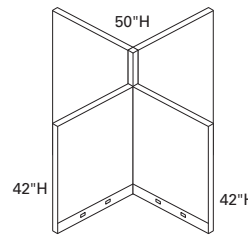

X-Connection Connector, Variable Height Finishing Kit

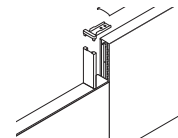

In-line Variable Height Trim Kit

NOTES:

- In-line Variable Height Finishing Kit is used to connect a finished in-line panel connection.
- Connector variable height finishing kit is used at a drop in height at an L, T, X, or S connection.
- All kits come with all hardware needed to install the kit.
- Variable height kit needs to be specified any time a change of panel height occurs.
- Finished end covers must be specified at all end of panel runs.
- If adding to existing panels produced prior to 04/13/16, please contact Customer Support for compatibility.

HOW TO SPECIFY

| | |
|--|---|
| <p>Select Model Number</p> <p>HEFEC35P</p> | <p>Select Paint Color</p> <p>See page 481</p> <p>T3</p> |
|--|---|

ACCELERATE® Bracket Kits and Stability Feet

GSA SIN 33721



Icon Legend on page 19

WORKSTATIONS



DESCRIPTION

Accelerate® Anchor Bracket
Package of ten

NOTES: For use when panels need to be anchored to the floor such as high traffic areas or community spaces.

⚠ Only available in Black (P).

SPECIFYING EXAMPLE: HEABAC.P

MODEL SHIP WEIGHT CUBE LIST PRICE

HEABAC 5 0.08 \$95

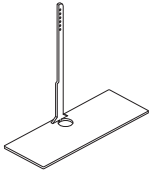

DESCRIPTION

Accelerate® Stability Foot

NOTES: Stabilizes bottom of panel from movement. Will not prohibit movement at top of panel.

MODEL SHIP WEIGHT CUBE LIST PRICE BY PAINT GRADE
P1 P2

HEFTAC 3 0.1 \$413 \$423

NOTES:

- ⚠ The Anchor Bracket and Stability Foot are not intended to create a freestanding panel. Please follow Accelerate® stability standards.
- ⚠ Attachment hardware for floor anchor not included.

HOW TO SPECIFY

| | |
|---|--|
| <p>Select Model Number</p> <p>HEFTAC .</p> | <p>Select Paint Color</p> <p>See page 481</p> <p>T1</p> |
|---|--|



Empower 2- and 4-Pack Benching Systems with Ignition® Seating, Voi® and Contain® Storage and Arrange® Tables.

EMPOWER®

Need a simple way to get up and running fast? No problem. Looking to expand and customize workstations for a growing business? Empower does that, too. With Empower benching, you've got the power to do more. Offer more personal space. Enjoy more adaptability. Route power more efficiently. It's simple to order, easy to install and quick to reconfigure. When you Empower your people, you keep pace with the changing demands of today's workplace.



FEATURES

- With numerous laminate selections to choose from, it's easy to get the exact look you want.
- Integrated height adjustability supports the work style of any user.
- Frosted glass. Colorful fabrics. Magnetic metal. Empower screens add style, privacy and functionality.
- Choose from multiple paint finishes to blend in or stand out.
- As the main electrical artery, power and data cables are laid into the trough.
- Plug power modules into the duplex in the trough and attach them to the worksurface for easy access to electrical and USB ports.
- Power entry can be accommodated through the ceiling, floor, or wall.
- Keep cords collected and controlled from floor to wire trough with vertebra.
- Support any work style by adding HON pedestals, credenzas and storage towers to Empower benching.

EMPOWER[®] FABRIC SCREENS — ALL PANEL MODELS

PRICE CODE AA

| FACTOR | FACT |
|-----------|--------|
| ◆ Bark | FACT20 |
| ◆ Barley | FACT15 |
| ◆ Cascade | FACT25 |
| ◆ Feather | FACT30 |

PRICE CODE A

| APPOINT | APN |
|---------------|-------|
| ◆ Artichoke | APN11 |
| ◆ Blackberry | APN32 |
| ◆ Bronze | APN22 |
| ◆ Carbon | APN28 |
| ◆ Chai | APN12 |
| ◆ Cherry | APN30 |
| ◆ Dark Pewter | APN17 |
| ◆ Dune | APN15 |
| ◆ Espresso | APN23 |
| ◆ Framboise | APN31 |
| ◆ Frost | APN34 |
| ◆ Jet | APN27 |
| ◆ Lawn | APN25 |
| ◆ Mandarin | APN29 |
| ◆ Morel | APN09 |
| ◆ Nimbus | APN16 |
| ◆ Platinum | APN24 |
| ◆ Turquoise | APN26 |

CENTURION CU

| | |
|-------------|------|
| ◆ Apricot | CU47 |
| ◆ Bark | CU25 |
| ◆ Black | CU10 |
| ◆ Espresso | CU49 |
| ◆ Fog | CU03 |
| ◆ Frost | CU22 |
| ◆ Goldenrod | CU27 |
| ◆ Indigo | CU06 |
| ◆ Iris | CU50 |
| ◆ Iron Ore | CU19 |
| ◆ Jade | CU83 |
| ◆ Marsala | CU63 |
| ◆ Morel | CU24 |
| ◆ Navy | CU98 |
| ◆ Peacock | CU97 |
| ◆ Pear | CU84 |
| ◆ Ruby | CU67 |
| ◆ Sapphire | CU09 |

PRICE CODE A *continued*

| ETCH* | ECH |
|-------------|-------|
| ◆ Axis | ECH13 |
| ◆ Blend | ECH14 |
| ◆ Cast | ECH12 |
| ◆ Highlight | ECH10 |
| ◆ Midtone | ECH11 |
| ◆ Outline | ECH08 |
| ◆ Shade | ECH09 |
| ◆ Tonal | ECH16 |
| ◆ Vanish | ECH15 |

EXCHANGE* EXG

| | |
|-------------|--------|
| ◆ Iron | EXG916 |
| ◆ Nickel | EXG914 |
| ◆ Pistachio | EXG910 |
| ◆ Root | EXG913 |
| ◆ Rupee | EXG903 |
| ◆ Shadow | EXG911 |
| ◆ Silver | EXG915 |
| ◆ Sisal | EXG917 |
| ◆ Stone | EXG912 |

LANDSCAPE* LN

| | |
|------------|------|
| ◆ Azure | LN55 |
| ◆ Cornsilk | LN15 |
| ◆ Drift | LN05 |
| ◆ Khaki | LN20 |
| ◆ Sheen | LN10 |
| ◆ Slate | LN35 |
| ◆ Umber | LN25 |
| ◆ Urban | LN30 |

LUCY* LC

| | |
|------------|------|
| ◆ Aspen | LC32 |
| ◆ Cornsilk | LC30 |
| ◆ Dusk | LC22 |
| ◆ Fawn | LC33 |
| ◆ Graphite | LC34 |
| ◆ Mist | LC20 |
| ◆ Neutra | LC24 |
| ◆ Pewter | LC35 |
| ◆ Snowdrop | LC28 |

PRICE CODE A *continued*

| REFLECTIONS* | REF |
|--------------|-------|
| ◆ Galvanized | REF29 |
| ◆ Ice | REF20 |
| ◆ Loggia | REF21 |
| ◆ Mistral | REF28 |
| ◆ Moonstone | REF23 |
| ◆ Pewter | REF22 |
| ◆ Stainless | REF24 |
| ◆ Vanilla | REF25 |
| ◆ Winter | REF27 |

REFUGE* RFG

| | |
|------------|-------|
| ◆ Artesian | RFG96 |
| ◆ Dune | RFG92 |
| ◆ Eclipse | RFG90 |
| ◆ Frost | RFG93 |
| ◆ Glacier | RFG91 |
| ◆ Mineral | RFG98 |
| ◆ Tidal | RFG94 |

SARTO* SRT

| | |
|--------------|-------|
| ◆ Ash | SRT88 |
| ◆ Fog | SRT14 |
| ◆ Lemongrass | SRT49 |
| ◆ Mist | SRT45 |
| ◆ Mushroom | SRT76 |
| ◆ Oyster | SRT18 |
| ◆ Reef | SRT64 |
| ◆ Sesame | SRT93 |
| ◆ Shale | SRT52 |

TEMPEST* TP

| | |
|---------------|------|
| ◆ Dragonfly | TP30 |
| ◆ Frost | TP15 |
| ◆ Full Stream | TP80 |
| ◆ Gold Rush | TP10 |
| ◆ Slate | TP45 |
| ◆ Tumbleweed | TP70 |
| ◆ Wind Chill | TP40 |
| ◆ Zebra | TP35 |

NOTES: Analog, Disperse, and Exchange panel fabrics will be applied pattern cut. Disperse will not be available on 72"W panels.

◆◆◆ For lead time information see page 19.

* Directional fabrics

EMPOWER® FABRIC SCREENS — ALL PANEL MODELS

| PRICE CODE B | | PRICE CODE B <i>continued</i> | | PRICE CODE B <i>continued</i> | | PRICE CODE B <i>continued</i> | |
|------------------|-------------|-------------------------------|------------|-------------------------------|-------------|-------------------------------|-------------|
| ANALOG* | ANLG | MICA* | MCA | SPIN* | SPIN | TERRAIN* | TRRN |
| ◆ Album | ANLG06 | ◆ Anthracite | MCA11 | ◆ Alabaster | SPIN02 | ◆ Bay | TRRN05 |
| ◆ Cartridge | ANLG04 | ◆ Breeze | MCA18 | ◆ Cavern | SPIN03 | ◆ Bayou | TRRN35 |
| ◆ Cassette | ANLG09 | ◆ Bronze | MCA13 | ◆ Cobblestone | SPIN04 | ◆ Canyon | TRRN30 |
| ◆ Dial | ANLG02 | ◆ Buff | MCA14 | ◆ Ember | SPIN06 | ◆ Cliff | TRRN45 |
| ◆ Media | ANLG08 | ◆ Cremini | MCA17 | ◆ Flame | SPIN07 | ◆ Crest | TRRN25 |
| ◆ Reel | ANLG07 | ◆ Crystal | MCAWIT | ◆ Heron | SPIN13 | ◆ Delta | TRRN10 |
| ◆ Signal | ANLG03 | ◆ Dew | MCA20 | ◆ Oat | SPIN01 | ◆ Plateau | TRRN15 |
| ◆ Stereo | ANLG01 | ◆ Dove | MCA12 | ◆ Ocean | SPIN12 | ◆ Ridge | TRRN20 |
| ◆ Track | ANLG05 | ◆ Fresh | MCA16 | ◆ Plum | SPIN15 | ◆ Valley | TRRN40 |
| | | ◆ Mineral | MCA15 | ◆ Pool | SPIN11 | | |
| COAST* | COA | ◆ Nectar | MCA19 | ◆ Raven | SPIN10 | | |
| ◆ Channel | COA14 | ◆ Shale | MCA10 | ◆ Rhubarb | SPIN14 | | |
| ◆ Dune | COA03 | | | ◆ Tropic | SPIN08 | | |
| ◆ Headlands | COA10 | | | ◆ Willow | SPIN05 | | |
| ◆ Marsh | COA02 | | | | | | |
| ◆ Pebble | COA12 | | | | | | |
| ◆ Pier | COA13 | | | | | | |
| ◆ Shoal | COA01 | | | | | | |
| ◆ Silt | COA06 | | | | | | |
| ◆ Tide | COA08 | | | | | | |
| DISPERSE* | DISP | | | | | | |
| ◆ Autumn | DISP03 | | | | | | |
| ◆ Branch | DISP10 | | | | | | |
| ◆ Coffee Bean | DISP13 | | | | | | |
| ◆ Dusk | DISP09 | | | | | | |
| ◆ Emerald City | DISP08 | | | | | | |
| ◆ Gold Rush | DISP02 | | | | | | |
| ◆ Igloo | DISP11 | | | | | | |
| ◆ Ink | DISP06 | | | | | | |
| ◆ Mist | DISP12 | | | | | | |
| ◆ Oatmeal | DISP15 | | | | | | |
| ◆ Prince | DISP07 | | | | | | |
| ◆ Reservoir | DISP01 | | | | | | |
| ◆ Rose | DISP04 | | | | | | |
| ◆ Spring | DISP05 | | | | | | |
| ◆ Steel | DISP16 | | | | | | |
| ◆ Taupe | DISP14 | | | | | | |

NOTES: Analog, Disperse, and Exchange panel fabrics will be applied pattern cut. Disperse will not be available on 72"W panels.

◆◆◆ For lead time information see page 19.

* Directional fabrics

EMPOWER[®] FINISH OPTIONS

WORKSURFACES

L1 LAMINATES CODES

- Woodgrain**
- ◆ Bourbon Cherry H
 - ◆ Cognac COGN
 - ◆ Florence Walnut LFW1
 - ◆ Harvest C
 - ◆ Kingswood Walnut LK11
 - ◆ Mahogany N
 - ◆ Mocha MOCH
 - ◆ Natural Maple D
 - ◆ Pinnacle PINC
 - ◆ Shaker Cherry F
 - ◆ Sterling Ash LSA1

- Solid**
- ◆ Black P
 - ◆ Charcoal S
 - ◆ Designer White LDW1
 - ◆ Loft LOFT

- Patterned**
- ◆ Handspun Chestnut LAHC
 - ◆ Handspun Dove LAHD
 - ◆ Handspun Pearl LAHP
 - ◆ Handspun Slate LAHS
 - ◆ Sheer Mesh * A5
 - ◆ Silver Mesh B9
 - ◆ Steel Mesh * A9
 - ◆ Canyon Zephyr * K9
 - ◆ Desert Zephyr * K8
 - ◆ Shadow Zephyr * K1
 - ◆ Gray G2
 - ◆ Grey Tigris * L6
 - ◆ White G1
 - ◆ Whitestone * K4

L2 LAMINATES CODES

- Woodgrain**
- ◆ Lowell Ash LLA1
 - ◆ Natural Recon LNR1
 - ◆ Phantom Ecrú LPE1
 - ◆ Portico Teak LPT1
 - ◆ Skyline Walnut LSW1

WORKSURFACE EDGE BAND

- Woodgrain**
- ◆ Bourbon Cherry H
 - ◆ Cognac COGN
 - ◆ Florence Walnut FW
 - ◆ Harvest C
 - ◆ Kingswood Walnut KI
 - ◆ Lowell Ash DL
 - ◆ Mahogany N
 - ◆ Mocha MOCH
 - ◆ Natural Maple D
 - ◆ Natural Recon NR
 - ◆ Phantom Ecrú PE
 - ◆ Pinnacle PINC
 - ◆ Portico Teak DP
 - ◆ Shaker Cherry F
 - ◆ Skyline Walnut SW
 - ◆ Sterling Ash SA

WORKSURFACE EDGE BAND *continued*

- Solid**
- ◆ Black P
 - ◆ Brownstone EY
 - ◆ Charcoal S
 - ◆ Designer White LDW1
 - ◆ Fossil EH
 - ◆ Greige R
 - ◆ Loft LOFT
 - ◆ Muslin T
 - ◆ Platinum K
 - ◆ Shadow * SHDW

END OF RUN SCREENS

L1 LAMINATES CODES

- Woodgrain**
- ◆ Bourbon Cherry H
 - ◆ Cognac COGN
 - ◆ Florence Walnut LFW1
 - ◆ Harvest C
 - ◆ Kingswood Walnut LK11
 - ◆ Mahogany N
 - ◆ Mocha MOCH
 - ◆ Natural Maple D
 - ◆ Pinnacle PINC
 - ◆ Shaker Cherry F
 - ◆ Sterling Ash LSA1

- Solid**
- ◆ Black P
 - ◆ Charcoal S
 - ◆ Designer White LDW1
 - ◆ Loft LOFT

- Patterned**
- ◆ Sheer Mesh A5
 - ◆ Silver Mesh B9

L2 LAMINATES CODES

- Woodgrain**
- ◆ Lowell Ash LLA1
 - ◆ Natural Recon LNR1
 - ◆ Phantom Ecrú LPE1
 - ◆ Portico Teak LPT1
 - ◆ Skyline Walnut LSW1

STATIC LEGS AND TROUGHS

PAINTS CODES

- P1**
- ◆ Black P
 - ◆ Brownstone P7D
 - ◆ Charcoal S
 - ◆ Designer White PJW
 - ◆ Fossil P28
 - ◆ Greige T5
 - ◆ Light Gray Q
 - ◆ Loft LOFT
 - ◆ Muslin T3
 - ◆ Putty L
 - ◆ Shadow * SHDW
 - ◆ Titanium P8T

- P2**
- ◆ Champagne Metallic T4
 - ◆ Platinum Metallic T1
 - ◆ Silver PR6
 - ◆ Solar Black P8X

- P3**
- ◆ Atom P8S
 - ◆ Bullseye PJF
 - ◆ Ember P8P
 - ◆ Ion P8N
 - ◆ Iris P8J
 - ◆ Krypton P8F
 - ◆ Regatta P8M

POWER POLE

PAINTS CODES

- P1**
- ◆ Black P
 - ◆ Charcoal S
 - ◆ Designer White PJW
 - ◆ Greige T5
 - ◆ Light Gray Q
 - ◆ Loft LOFT
 - ◆ Muslin T3
 - ◆ Shadow * SHDW

PAINTED METAL SCREENS AND SCREEN BRACKETS

PAINTS CODES

- P1**
- ◆ Black P
 - ◆ Brownstone P7D
 - ◆ Charcoal S
 - ◆ Designer White PJW
 - ◆ Fossil P28
 - ◆ Greige T5
 - ◆ Light Gray Q
 - ◆ Loft LOFT
 - ◆ Muslin T3
 - ◆ Putty L
 - ◆ Shadow * SHDW
 - ◆ Titanium P8T

- P2**
- ◆ Champagne Metallic T4
 - ◆ Platinum Metallic T1
 - ◆ Silver PR6
 - ◆ Solar Black P8X
 - ◆ White Markerboard MKB

- P3**
- ◆ Atom P8S
 - ◆ Bullseye PJF
 - ◆ Ember P8P
 - ◆ Ion P8N
 - ◆ Iris P8J
 - ◆ Krypton P8F
 - ◆ Regatta P8M

Recommended Color to use with Duplex and Data Electric Kits

| Paint | Duplex-Data Code |
|-----------------------|-------------------|
| Black P | Black P |
| Brownstone P7D | Brownstone EY |
| Charcoal S | Charcoal S |
| Designer White PJW | Designer White DW |
| Fossil P28 | Charcoal S |
| Greige T5 | Muslin T3 |
| Light Gray Q | Loft LOFT |
| Loft LOFT | Loft LOFT |
| Muslin T3 | Muslin T3 |
| Putty L | Black P |
| Shadow SHDW | Muslin T3 |
| Silver PR6 | Titanium T1 |
| Titanium P8T | Titanium T1 |
| Champagne Metallic T4 | Muslin T3 |
| Platinum Metallic T1 | Titanium T1 |

| WORKSURFACE LAMINATES | CODES | EDGE BAND OPTIONS | | | | | | | | | | | |
|-----------------------|-------|-------------------|---------------------|-------------|------------|---------------|-----------|-----------------|--------------|-------------|------------|----------------|--------------|
| | | Matching Edge | Designer White (DW) | Loft (LOFT) | Muslin (T) | Shadow (SHDW) | Black (P) | Brownstone (EY) | Charcoal (S) | Fossil (EH) | Greige (R) | Light Gray (Q) | Platinum (K) |
| Black | P | | | | | | * | | | | | | |
| Bourbon Cherry | H | * | * | | * | | | | | | | | |
| Charcoal | S | | | | | | | * | | | | | |
| Cognac | COGN | * | * | | * | | | | | | | | |
| Designer White | LDW1 | | * | | | | | | | | | | |
| Handspun Chestnut | LAHC | * | * | * | * | | * | * | * | * | * | * | * |
| Handspun Dove | LAHD | * | * | * | * | | * | * | * | * | * | * | * |
| Handspun Pearl | LAHP | * | * | * | * | | * | * | * | * | * | * | * |
| Handspun Slate | LAHS | * | * | * | * | | * | * | * | * | * | * | * |
| Harvest | C | * | * | | * | | | | | | | | |
| Loft | LOFT | | | * | | | | | | | | | |
| Lowell Ash | LLA1 | * | * | * | * | | | | | | | | |
| Mahogany | N | * | * | * | * | * | | | | | | | |
| Mocha | MOCH | * | * | * | * | | | | | | | | |
| Natural Maple | D | * | * | * | * | | | | | | | | |
| Natural Recon | LNR1 | * | * | * | * | | | | | | | | |
| Phantom Ecrú | LPE1 | * | * | * | * | | | | | | | | |
| Pinnacle | PINC | * | * | * | * | | | | | | | | |
| Portico Teak | LPT1 | * | * | * | * | | | | | | | | |
| Shaker Cherry | F | * | * | * | * | * | | | | | | | |
| Sheer Mesh | A5 | | | * | | | | | | | | | |
| Silver Mesh | B9 | | | * | | | | | | | | | |
| Skyline Walnut | LSW1 | * | * | * | * | | | | | | | | |
| Sterling Ash | LSA1 | * | * | * | * | * | | | | | | | |

◆◆◆ For lead time information see page 19.
* De-emphasized

EMPOWER[®]

Step-by-Step Guide

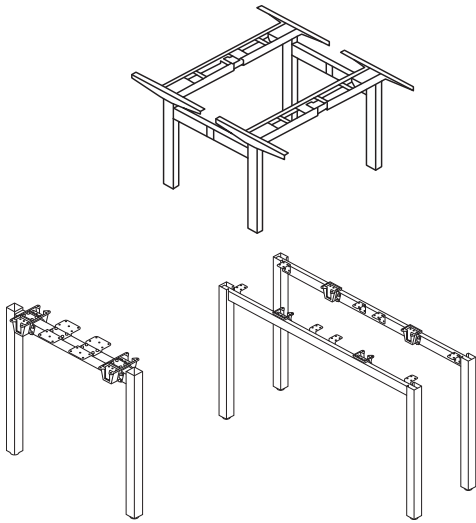

STEP 1: LEGS

All necessary brackets ship attached to the legs.

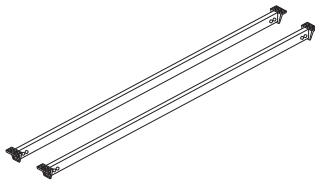

STEP 2: SUPPORT BEAMS (STATIC ONLY)

All necessary brackets ship attached to the beam. Simply fasten to the legs with the provided screws.

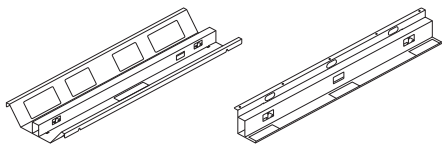

STEP 3: TROUGHS

Slide the trough over the support beams for double-sided. Screw the trough into the surface for single-sided.

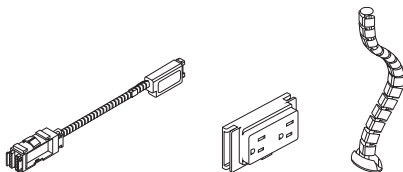

STEP 4: ELECTRICAL

Slide 8-wire harnesses/duplexes into pre-installed clips on the trough. Lay in data if necessary and cover.

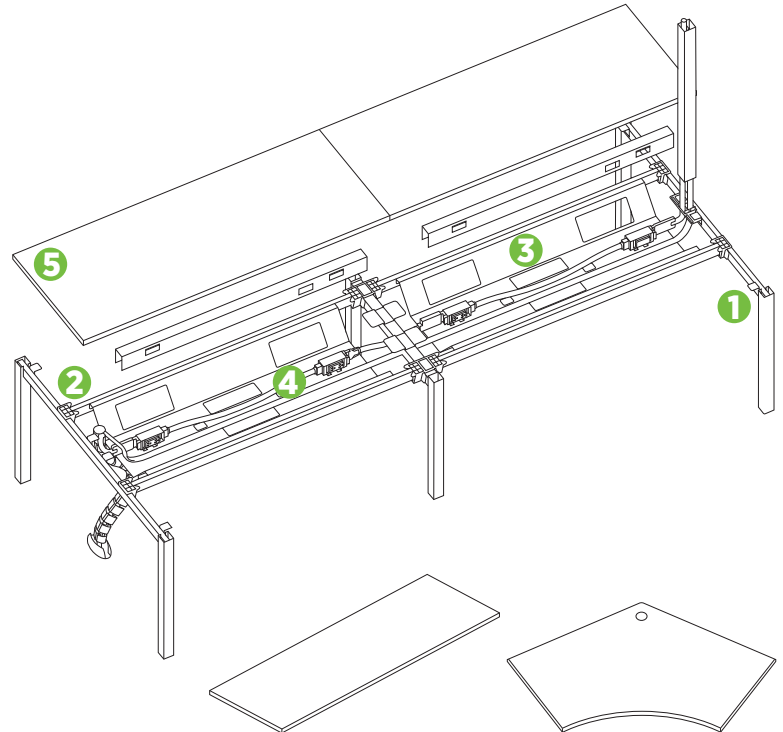

STEP 5: WORKSURFACES

All necessary brackets ship attached to the beam. Simply fasten to the legs with the provided screws.

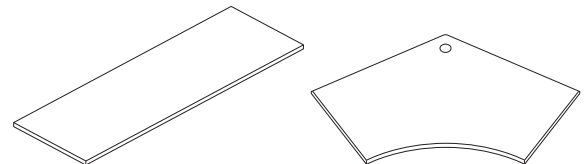

STEP 6: SCREENS

Drop shared screens into installed brackets, slide side screens into place or attach end of run screens at end of worksurfaces.

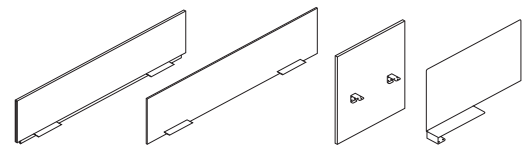

STEP 7: STORAGE

Choose your storage, from pedestals, to credenzas to towers — whatever suits your needs.

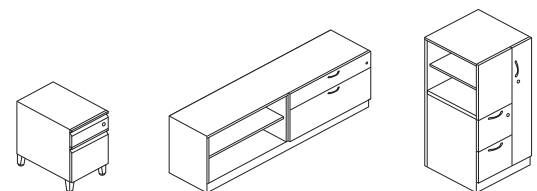

EMPOWER[®] 72"W Typical with 24"D Worksurfaces



Icon Legend on page 19

WORKSTATIONS

| QTY | DESCRIPTION | MODEL | LIST PRICE | PRICE EXTENSION |
|---------------|---|------------|----------------|-----------------|
| 2 | Worksurface, Edgeband, No Grommets 24" x 72" | HWR2472PN | \$583 | \$1,166 |
| 1 | Double Depth U-Leg (Box of 2) | HMPEL4828 | \$1,251 | \$1,251 |
| 1 | Support Beams (Box of 2) 72"W | HMPUB272 | \$775 | \$775 |
| 1 | Shared Trough 72"W | HMPROUGH72 | \$528 | \$528 |
| 1 | End of Run Electrical Kit 72"W | HMPEEK72 | \$249 | \$249 |
| 1 | Duplex 1 | HH871501 | \$47 | \$47 |
| 1 | Duplex 2 | HH871502 | \$47 | \$47 |
| 1 | Duplex 3 | HH871503 | \$47 | \$47 |
| 1 | Duplex 4 | HH871504 | \$47 | \$47 |
| TOTAL: | | | \$4,157 | |

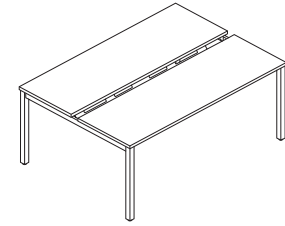

**2-PACK — 72"
72"W x 51"D**

| QTY | DESCRIPTION | BUNDLE SKU | LIST PRICE |
|-----|--|------------|----------------|
| 1 | 2-PACK BUNDLE Includes all Components Listed Above | HMP2472PK2 | \$4,396 |

SPECIFYING EXAMPLE: Model.Laminate.Edgeband.Paint2.DuplexColor

NOTES: Typical DO NOT include power in-feeds, screens, storage, or seating.

ADD 1 FABRIC SCREEN: \$803— SEE PAGE 535

ADD 2 MOBILE PEDESTALS: \$1,326— SEE PAGE 569

SEE PAGE 538 FOR BUNDLE SKU INFORMATION

| QTY | DESCRIPTION | MODEL | LIST PRICE | PRICE EXTENSION |
|---------------|---|------------|----------------|-----------------|
| 4 | Worksurface, Edgeband, No Grommets 24" x 72" | HWR2472PN | \$583 | \$2,332 |
| 1 | Double Depth U-Leg (Box of 2) | HMPEL4828 | \$1,251 | \$1,251 |
| 1 | Double Depth Shared U-Leg (Singles) | HMPSL4828 | \$516 | \$516 |
| 2 | Support Beams (Box of 2) 72"W | HMPUB272 | \$775 | \$1,550 |
| 2 | Shared Trough 72"W | HMPROUGH72 | \$528 | \$1,056 |
| 1 | Power Harness 72"W | HH871272 | \$239 | \$239 |
| 1 | End of Run Electrical Kit 72"W | HMPEEK72 | \$249 | \$249 |
| 2 | Duplex 1 | HH871501 | \$47 | \$94 |
| 2 | Duplex 2 | HH871502 | \$47 | \$94 |
| 2 | Duplex 3 | HH871503 | \$47 | \$94 |
| 2 | Duplex 4 | HH871504 | \$47 | \$94 |
| TOTAL: | | | \$7,569 | |

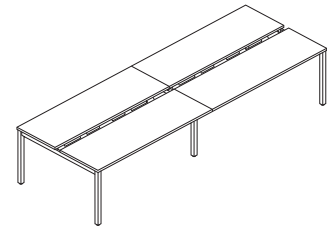

**4-PACK — 72"
144"W x 51"D**

| QTY | DESCRIPTION | BUNDLE SKU | LIST PRICE |
|-----|--|------------|----------------|
| 1 | 4-PACK BUNDLE Includes all Components Listed Above | HMP2472PK4 | \$7,569 |

SPECIFYING EXAMPLE: Model.Laminate.Edgeband.Paint2.DuplexColor

NOTES: Typical DO NOT include power in-feeds, screens, storage, or seating.

ADD 2 FABRIC SCREENS: \$1,606— SEE PAGE 535

ADD 4 MOBILE PEDESTALS: \$2,652— SEE PAGE 569

SEE PAGE 538 FOR BUNDLE SKU INFORMATION



Icon Legend on page 19

EMPOWER[®]

72"W Typicals with 24"D Worksurfaces

| QTY | DESCRIPTION | MODEL | LIST PRICE | PRICE EXTENSION |
|---------------|---|------------|------------|-----------------|
| 6 | Worksurface, Edgeband, No Grommets 24" x 72" | HWR2472PN | \$583 | \$3,498 |
| 1 | Double Depth U-Leg (Box of 2) | HMPEL4828 | \$1,251 | \$1,251 |
| 2 | Double Depth Shared U-Leg (Singles) | HMPSL4828 | \$516 | \$1,032 |
| 3 | Support Beams (Box of 2) 72"W | HMPUB272 | \$775 | \$2,325 |
| 3 | Shared Trough 72"W | HMPROUGH72 | \$528 | \$1,584 |
| 2 | Power Harness 72"W | HH871272 | \$239 | \$478 |
| 1 | End of Run Electrical Kit 72"W | HMPEEK72 | \$249 | \$249 |
| 3 | Duplex 1 | HH871501 | \$47 | \$141 |
| 3 | Duplex 2 | HH871502 | \$47 | \$141 |
| 3 | Duplex 3 | HH871503 | \$47 | \$141 |
| 3 | Duplex 4 | HH871504 | \$47 | \$141 |
| TOTAL: | | | | \$10,981 |

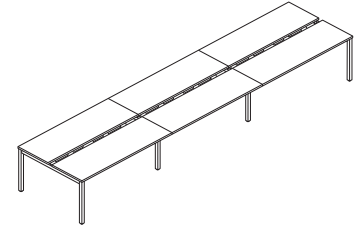

6-PACK — 72"
216" W x 51" D

| QTY | DESCRIPTION | BUNDLE SKU | LIST PRICE |
|-----|--|------------|-----------------|
| 1 | 6-PACK BUNDLE Includes all Components Listed Above | HMP2472PK6 | \$10,981 |

SPECIFYING EXAMPLE: Model.Laminate.Edgeband.Paint2.DuplexColor

NOTES: Typicals DO NOT include power in-feeds, screens, storage, or seating.

ADD 3 FABRIC SCREENS: \$2,409 — SEE PAGE 535

ADD 6 MOBILE PEDESTALS: \$3,978 — SEE PAGE 569

SEE PAGE 538 FOR BUNDLE SKU INFORMATION

| QTY | DESCRIPTION | MODEL | LIST PRICE | PRICE EXTENSION |
|---------------|---|------------|------------|-----------------|
| 8 | Worksurface, Edgeband, No Grommets 24" x 72" | HWR2472PN | \$583 | \$4,664 |
| 1 | Double Depth U-Leg (Box of 2) | HMPEL4828 | \$1,251 | \$1,251 |
| 3 | Double Depth Shared U-Leg (Singles) | HMPSL4828 | \$516 | \$1,548 |
| 4 | Support Beams (Box of 2) 72"W | HMPUB272 | \$775 | \$3,100 |
| 4 | Shared Trough 72"W | HMPROUGH72 | \$528 | \$2,112 |
| 3 | Power Harness 72"W | HH871272 | \$239 | \$717 |
| 1 | End of Run Electrical Kit 72"W | HMPEEK72 | \$249 | \$249 |
| 4 | Duplex 1 | HH871501 | \$47 | \$188 |
| 4 | Duplex 2 | HH871502 | \$47 | \$188 |
| 4 | Duplex 3 | HH871503 | \$47 | \$188 |
| 4 | Duplex 4 | HH871504 | \$47 | \$188 |
| TOTAL: | | | | \$14,393 |

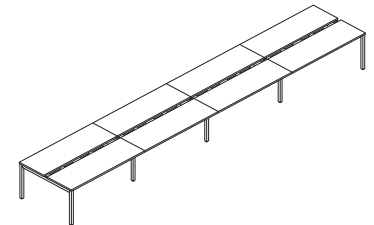

8-PACK — 72"
288" W x 51" D

| QTY | DESCRIPTION | BUNDLE SKU | LIST PRICE |
|-----|--|------------|-----------------|
| 1 | 8-PACK BUNDLE Includes all Components Listed Above | HMP2472PK8 | \$14,393 |

SPECIFYING EXAMPLE: Model.Laminate.Edgeband.Paint2.DuplexColor

NOTES: Typicals DO NOT include power in-feeds, screens, storage, or seating.

ADD 4 FABRIC SCREENS: \$3,212 — SEE PAGE 535

ADD 8 MOBILE PEDESTALS: \$5,304 — SEE PAGE 569

SEE PAGE 538 FOR BUNDLE SKU INFORMATION



| QTY | DESCRIPTION | MODEL | LIST PRICE | PRICE EXTENSION |
|-----|---|--------------|------------|-----------------|
| 2 | Electrical Power Harness Panels w/Duplex Capacity | HH871272 | \$239 | \$478 |
| 1 | End of Run Electrical Kit 72"W | HMPPEEK72 | \$249 | \$249 |
| 1 | Duplex Receptacle Circuit 1 3-1 & 2-2 Systems | HH871501 | \$47 | \$47 |
| 1 | Duplex Receptacle Circuit 2 3-1 & 2-2 Systems | HH871502 | \$47 | \$47 |
| 1 | Duplex Receptacle Circuit 3 3-1 System Only | HH871503 | \$47 | \$47 |
| 3 | Duplex Receptacle Circuit 4 3-1 & 2-2 Systems | HH871504 | \$47 | \$141 |
| 1 | Single Depth U-Leg (Box of 2) | HMPPEL2428 | \$625 | \$625 |
| 1 | Single Depth Return Leg — Left | HMPRLEL2428 | \$381 | \$381 |
| 2 | Single Depth Return Leg — Right | HMPRREL2428 | \$381 | \$762 |
| 2 | Single Depth Shared U-Leg (Singles) | HMPSL2428 | \$381 | \$762 |
| 3 | Single-Side Trough 72"W | HMPSTROUGH72 | \$561 | \$1,683 |
| 2 | Support Beams (Box of 1) 48"W | HMPUB148 | \$315 | \$630 |
| 1 | Support Beams (Box of 1) 60"W | HMPUB160 | \$352 | \$352 |
| 3 | Support Beams (Box of 1) 72"W | HMPUB172 | \$390 | \$1,170 |
| 2 | Systems Rectangular Worksurface, Edgeband, No Grommets 24"D x 36"W | HWR2436PN | \$382 | \$764 |
| 1 | Systems Rectangular Worksurface, Edgeband, No Grommets 24"D x 48"W | HWR2448PN | \$446 | \$446 |
| 3 | Systems Rectangular Worksurface, Edgeband, No Grommets 24"D x 72"W | HWR2472PN | \$583 | \$1,749 |

TOTAL: \$10,333

NOTES: Typicals DO NOT include power in-feeds, screens, storage, or seating.

ADD 3 FABRIC SCREENS: \$2,178 — SEE PAGE 535

ADD 3 MOBILE PEDESTALS: \$1,989 — SEE PAGE 569

SEE PAGE 538 FOR BUNDLE SKU INFORMATION

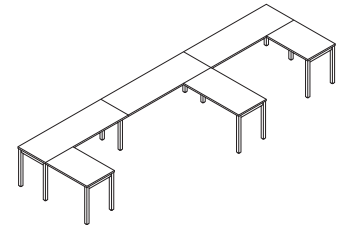

**6-PACK W/RETURNS — 72"
216"W x 72"D**

| QTY | DESCRIPTION | MODEL | LIST PRICE | PRICE EXTENSION |
|-----|---|--------------|------------|-----------------|
| 2 | Electrical Power Harness Panels w/Duplex Capacity | HH871272 | \$239 | \$478 |
| 1 | End of Run Electrical Kit 72"W | HMPPEEK72 | \$249 | \$249 |
| 3 | Duplex Receptacle Circuit 1 3-1 & 2-2 Systems | HH871501 | \$47 | \$141 |
| 3 | Duplex Receptacle Circuit 2 3-1 & 2-2 Systems | HH871502 | \$47 | \$141 |
| 3 | Duplex Receptacle Circuit 3 3-1 System Only | HH871503 | \$47 | \$141 |
| 3 | Duplex Receptacle Circuit 4 3-1 & 2-2 Systems | HH871504 | \$47 | \$141 |
| 1 | Double Depth U-Leg (Box of 2) | HMPPEL4828 | \$1,251 | \$1,251 |
| 2 | Single Depth Return Leg — Left | HMPRLEL2428 | \$381 | \$762 |
| 2 | Single Depth Return Leg — Right | HMPRREL2428 | \$381 | \$762 |
| 2 | Double Depth Shared U-Leg (Singles) | HMPSL4828 | \$516 | \$1,032 |
| 3 | Shared Trough 72"W | HMPSTROUGH72 | \$528 | \$1,584 |
| 3 | Support Beams (Box of 1) 48"W | HMPUB148 | \$315 | \$945 |
| 1 | Support Beams (Box of 1) 60"W | HMPUB160 | \$352 | \$352 |
| 3 | Support Beams (Box of 2) 72"W | HMPUB272 | \$775 | \$2,325 |
| 3 | Systems Rectangular Worksurface, Edgeband, No Grommets 24"D x 36"W | HWR2436PN | \$382 | \$1,146 |
| 1 | Systems Rectangular Worksurface, Edgeband, No Grommets 24"D x 48"W | HWR2448PN | \$446 | \$446 |
| 6 | Systems Rectangular Worksurface, Edgeband, No Grommets 24"D x 72"W | HWR2472PN | \$583 | \$3,498 |

TOTAL: \$15,394

NOTES: Typicals DO NOT include power in-feeds, screens, storage, or seating.

ADD 3 FABRIC SCREENS: \$2,409 — SEE PAGE 535

ADD 6 MOBILE PEDESTALS: \$3,978 — SEE PAGE 569

SEE PAGE 538 FOR BUNDLE SKU INFORMATION

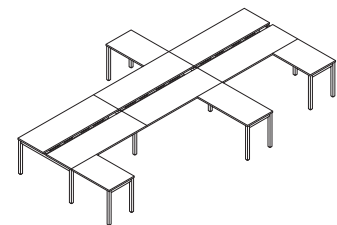

**3-PACK W/RETURNS — 72"
216"W x 132"D**



Icon Legend on page 19

EMPOWER[®]

60"W Typical with 24"D Worksurfaces

| QTY | DESCRIPTION | MODEL | LIST PRICE | PRICE EXTENSION |
|---------------|---|------------|----------------|-----------------|
| 2 | Worksurface, Edgeband, No Grommets 24" x 60" | HWR2460PN | \$526 | \$1,052 |
| 1 | Double Depth U-Leg (Box of 2) | HMPEL4828 | \$1,251 | \$1,251 |
| 1 | Support Beams (Box of 2) 60"W | HMPUB260 | \$700 | \$700 |
| 1 | Shared Trough 60"W | HMPROUGH60 | \$481 | \$481 |
| 1 | End of Run Electrical Kit 60"W | HMPEEK60 | \$249 | \$249 |
| 1 | Duplex 1 | HH871501 | \$47 | \$47 |
| 1 | Duplex 2 | HH871502 | \$47 | \$47 |
| 1 | Duplex 3 | HH871503 | \$47 | \$47 |
| 1 | Duplex 4 | HH871504 | \$47 | \$47 |
| TOTAL: | | | \$3,921 | |

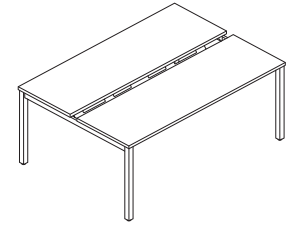

2-PACK — 60"
60"W x 51"D

| QTY | DESCRIPTION | BUNDLE SKU | LIST PRICE |
|-----|--|------------|----------------|
| 1 | 2-PACK BUNDLE Includes all Components Listed Above | HMP2460PK2 | \$4,409 |

SPECIFYING EXAMPLE: Model.Laminate.Edgeband.Paint2.DuplexColor

NOTES: Typicals DO NOT include power in-feeds, screens, storage, or seating.

ADD 1 FABRIC SCREEN: \$724 — SEE PAGE 535

ADD 2 MOBILE PEDESTALS: \$1,326 — SEE PAGE 569

SEE PAGE 538 FOR BUNDLE SKU INFORMATION

| QTY | DESCRIPTION | MODEL | LIST PRICE | PRICE EXTENSION |
|---------------|---|------------|----------------|-----------------|
| 4 | Worksurface, Edgeband, No Grommets 24" x 60" | HWR2460PN | \$526 | \$2,104 |
| 1 | Double Depth U-Leg (Box of 2) | HMPEL4828 | \$1,251 | \$1,251 |
| 1 | Double Depth Shared U-Leg (Singles) | HMPSL4828 | \$516 | \$516 |
| 2 | Support Beams (Box of 2) 60"W | HMPUB260 | \$700 | \$1,400 |
| 2 | Shared Trough 60"W | HMPROUGH60 | \$481 | \$962 |
| 1 | Power Harness 60"W | HH871260 | \$239 | \$239 |
| 1 | End of Run Electrical Kit 60"W | HMPEEK60 | \$249 | \$249 |
| 2 | Duplex 1 | HH871501 | \$47 | \$94 |
| 2 | Duplex 2 | HH871502 | \$47 | \$94 |
| 2 | Duplex 3 | HH871503 | \$47 | \$94 |
| 2 | Duplex 4 | HH871504 | \$47 | \$94 |
| TOTAL: | | | \$7,097 | |

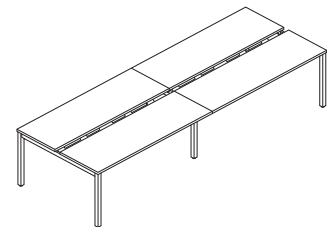

4-PACK — 60"
144"W x 51"D

| QTY | DESCRIPTION | BUNDLE SKU | LIST PRICE |
|-----|--|------------|----------------|
| 1 | 4-PACK BUNDLE Includes all Components Listed Above | HMP2460PK4 | \$7,097 |

SPECIFYING EXAMPLE: Model.Laminate.Edgeband.Paint2.DuplexColor

NOTES: Typicals DO NOT include power in-feeds, screens, storage, or seating.

ADD 2 FABRIC SCREENS: \$1,448 — SEE PAGE 535

ADD 4 MOBILE PEDESTALS: \$2,652 — SEE PAGE 569

SEE PAGE 538 FOR BUNDLE SKU INFORMATION

EMPOWER[®]

60"W Typicals with 24"D Worksurfaces



Icon Legend on page 19

WORKSTATIONS

| QTY | DESCRIPTION | MODEL | LIST PRICE | PRICE EXTENSION |
|---------------|---|-------------|------------|-----------------|
| 6 | Worksurface, Edgeband, No Grommets 24" x 60" | HWR2460PN | \$526 | \$3,156 |
| 1 | Double Depth U-Leg (Box of 2) | HMPEL4828 | \$1,251 | \$1,251 |
| 2 | Double Depth Shared U-Leg (Singles) | HMPSL4828 | \$516 | \$1,032 |
| 3 | Support Beams (Box of 2) 60"W | HMPUB260 | \$700 | \$2,100 |
| 3 | Shared Trough 60"W | HMPTROUGH60 | \$481 | \$1,443 |
| 2 | Power Harness 60"W | HH871260 | \$239 | \$478 |
| 1 | End of Run Electrical Kit 60"W | HMPEEK60 | \$249 | \$249 |
| 3 | Duplex 1 | HH871501 | \$47 | \$141 |
| 3 | Duplex 2 | HH871502 | \$47 | \$141 |
| 3 | Duplex 3 | HH871503 | \$47 | \$141 |
| 3 | Duplex 4 | HH871504 | \$47 | \$141 |
| TOTAL: | | | | \$10,273 |

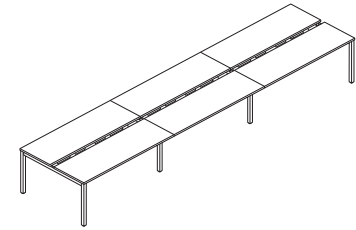

**6-PACK — 60"
180"W x 51"D**

| QTY | DESCRIPTION | BUNDLE SKU | LIST PRICE |
|-----|--|------------|-----------------|
| 1 | 6-PACK BUNDLE Includes all Components Listed Above | HMP2460PK6 | \$10,273 |

SPECIFYING EXAMPLE: Model.Laminate.Edgeband.Paint2.DuplexColor

NOTES: Typicals DO NOT include power in-feeds, screens, storage, or seating.

ADD 3 FABRIC SCREENS: \$2,172 — SEE PAGE 535

ADD 6 MOBILE PEDESTALS: \$3,978 — SEE PAGE 569

SEE PAGE 538 FOR BUNDLE SKU INFORMATION

| QTY | DESCRIPTION | MODEL | LIST PRICE | PRICE EXTENSION |
|---------------|---|-------------|------------|-----------------|
| 8 | Worksurface, Edgeband, No Grommets 24" x 60" | HWR2460PN | \$526 | \$4,208 |
| 1 | Double Depth U-Leg (Box of 2) | HMPEL4828 | \$1,251 | \$1,251 |
| 3 | Double Depth Shared U-Leg (Singles) | HMPSL4828 | \$516 | \$1,548 |
| 4 | Support Beams (Box of 2) 60"W | HMPUB260 | \$700 | \$2,800 |
| 4 | Shared Trough 60"W | HMPTROUGH60 | \$481 | \$1,924 |
| 3 | Power Harness 60"W | HH871260 | \$239 | \$717 |
| 1 | End of Run Electrical Kit 60"W | HMPEEK60 | \$249 | \$249 |
| 4 | Duplex 1 | HH871501 | \$47 | \$188 |
| 4 | Duplex 2 | HH871502 | \$47 | \$188 |
| 4 | Duplex 3 | HH871503 | \$47 | \$188 |
| 4 | Duplex 4 | HH871504 | \$47 | \$188 |
| TOTAL: | | | | \$13,449 |

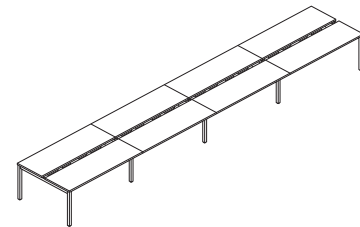

**8-PACK — 60"
240"W x 51"D**

| QTY | DESCRIPTION | BUNDLE SKU | LIST PRICE |
|-----|--|------------|-----------------|
| 1 | 8-PACK BUNDLE Includes all Components Listed Above | HMP2460PK8 | \$13,449 |

SPECIFYING EXAMPLE: Model.Laminate.Edgeband.Paint2.DuplexColor

NOTES: Typicals DO NOT include power in-feeds, screens, storage, or seating.

ADD 4 FABRIC SCREENS: \$2,896 — SEE PAGE 535

ADD 8 MOBILE PEDESTALS: \$5,304 — SEE PAGE 569

SEE PAGE 538 FOR BUNDLE SKU INFORMATION



Icon Legend on page 19

EMPOWER[®]

72"W Typicals with 30"D Worksurfaces

| QTY | DESCRIPTION | MODEL | LIST PRICE | PRICE EXTENSION |
|---------------|---|------------|----------------|-----------------|
| 2 | Worksurface, Edgeband, No Grommets 30" x 72" | HWR3072PN | \$653 | \$1,306 |
| 1 | Double Depth U-Leg (Box of 2) | HMPEL6028 | \$1,375 | \$1,375 |
| 1 | Support Beams (Box of 2) 72"W | HMPUB272 | \$775 | \$775 |
| 1 | Shared Trough 72"W | HMPROUGH72 | \$528 | \$528 |
| 1 | End of Run Electrical Kit 72"W | HMPEEK72 | \$249 | \$249 |
| 1 | Duplex 1 | HH871501 | \$47 | \$47 |
| 1 | Duplex 2 | HH871502 | \$47 | \$47 |
| 1 | Duplex 3 | HH871503 | \$47 | \$47 |
| 1 | Duplex 4 | HH871504 | \$47 | \$47 |
| TOTAL: | | | \$4,421 | |

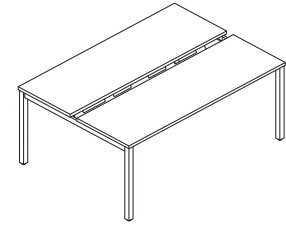

2-PACK — 72"
72"W x 63"D

| QTY | DESCRIPTION | BUNDLE SKU | LIST PRICE |
|-----|--|------------|----------------|
| 1 | 2-PACK BUNDLE Includes all Components Listed Above | HMP3072PK2 | \$4,660 |

SPECIFYING EXAMPLE: Model.Laminate.Edgeband.Paint2.DuplexColor

NOTES: Typicals DO NOT include power in-feeds, screens, storage, or seating.

ADD 1 FABRIC SCREEN: \$803 — SEE PAGE 535

ADD 2 MOBILE PEDESTALS: \$1,326 — SEE PAGE 569

SEE PAGE 538 FOR BUNDLE SKU INFORMATION

| QTY | DESCRIPTION | MODEL | LIST PRICE | PRICE EXTENSION |
|---------------|---|------------|----------------|-----------------|
| 4 | Worksurface, Edgeband, No Grommets 30" x 72" | HWR3072PN | \$653 | \$2,612 |
| 1 | Double Depth U-Leg (Box of 2) | HMPEL6028 | \$1,375 | \$1,375 |
| 1 | Double Depth Shared U-Leg (Singles) | HMPSL6028 | \$567 | \$567 |
| 2 | Support Beams (Box of 2) 72"W | HMPUB272 | \$775 | \$1,550 |
| 2 | Shared Trough 72"W | HMPROUGH72 | \$528 | \$1,056 |
| 1 | Power Harness 72"W | HH871272 | \$239 | \$239 |
| 1 | End of Run Electrical Kit 72"W | HMPEEK72 | \$249 | \$249 |
| 2 | Duplex 1 | HH871501 | \$47 | \$94 |
| 2 | Duplex 2 | HH871502 | \$47 | \$94 |
| 2 | Duplex 3 | HH871503 | \$47 | \$94 |
| 2 | Duplex 4 | HH871504 | \$47 | \$94 |
| TOTAL: | | | \$8,024 | |

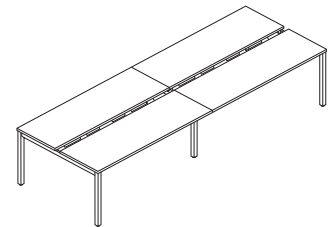

4-PACK — 72"
144"W x 63"D

| QTY | DESCRIPTION | BUNDLE SKU | LIST PRICE |
|-----|--|------------|----------------|
| 1 | 4-PACK BUNDLE Includes all Components Listed Above | HMP3072PK4 | \$8,024 |

SPECIFYING EXAMPLE: Model.Laminate.Edgeband.Paint2.DuplexColor

NOTES: Typicals DO NOT include power in-feeds, screens, storage, or seating.

ADD 2 FABRIC SCREENS: \$1,606 — SEE PAGE 535

ADD 4 MOBILE PEDESTALS: \$2,652 — SEE PAGE 569

SEE PAGE 538 FOR BUNDLE SKU INFORMATION

EMPOWER® 72"W Typicals with 30"D Worksurfaces



Icon Legend on page 19

WORKSTATIONS

| QTY | DESCRIPTION | MODEL | LIST PRICE | PRICE EXTENSION |
|---------------|---|------------|------------|-----------------|
| 6 | Worksurface, Edgeband, No Grommets 30" x 72" | HWR3072PN | \$653 | \$3,918 |
| 1 | Double Depth U-Leg (Box of 2) | HMPEL6028 | \$1,375 | \$1,375 |
| 2 | Double Depth Shared U-Leg (Singles) | HMPSL6028 | \$567 | \$1,134 |
| 3 | Support Beams (Box of 2) 72"W | HMPUB272 | \$775 | \$2,325 |
| 3 | Shared Trough 72"W | HMPROUGH72 | \$528 | \$1,584 |
| 2 | Power Harness 72"W | HH871272 | \$239 | \$478 |
| 1 | End of Run Electrical Kit 72"W | HMPEEK72 | \$249 | \$249 |
| 3 | Duplex 1 | HH871501 | \$47 | \$141 |
| 3 | Duplex 2 | HH871502 | \$47 | \$141 |
| 3 | Duplex 3 | HH871503 | \$47 | \$141 |
| 3 | Duplex 4 | HH871504 | \$47 | \$141 |
| TOTAL: | | | | \$11,627 |

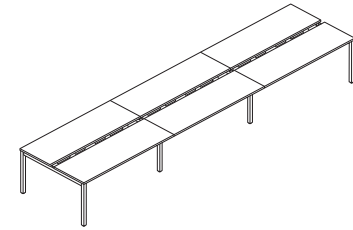

**6-PACK — 72"
216"W x 63"D**

| QTY | DESCRIPTION | BUNDLE SKU | LIST PRICE |
|-----|--|------------|-----------------|
| 1 | 6-PACK BUNDLE Includes all Components Listed Above | HMP3072PK6 | \$11,627 |

SPECIFYING EXAMPLE: Model.Laminate.Edgeband.Paint2.DuplexColor

NOTES: Typicals DO NOT include power in-feeds, screens, storage, or seating.

ADD 3 FABRIC SCREENS: \$2,409 — SEE PAGE 535

ADD 6 MOBILE PEDESTALS: \$3,978 — SEE PAGE 569

SEE PAGE 538 FOR BUNDLE SKU INFORMATION

| QTY | DESCRIPTION | MODEL | LIST PRICE | PRICE EXTENSION |
|---------------|---|------------|------------|-----------------|
| 8 | Worksurface, Edgeband, No Grommets 30" x 72" | HWR3072PN | \$653 | \$5,224 |
| 1 | Double Depth U-Leg (Box of 2) | HMPEL6028 | \$1,375 | \$1,375 |
| 3 | Double Depth Shared U-Leg (Singles) | HMPSL6028 | \$567 | \$1,701 |
| 4 | Support Beams (Box of 2) 72"W | HMPUB272 | \$775 | \$3,100 |
| 4 | Shared Trough 72"W | HMPROUGH72 | \$528 | \$2,112 |
| 3 | Power Harness 72"W | HH871272 | \$239 | \$717 |
| 1 | End of Run Electrical Kit 72"W | HMPEEK72 | \$249 | \$249 |
| 4 | Duplex 1 | HH871501 | \$47 | \$188 |
| 4 | Duplex 2 | HH871502 | \$47 | \$188 |
| 4 | Duplex 3 | HH871503 | \$47 | \$188 |
| 4 | Duplex 4 | HH871504 | \$47 | \$188 |
| TOTAL: | | | | \$15,230 |

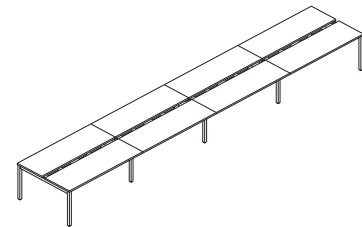

**8-PACK — 72"
288"W x 63"D**

| QTY | DESCRIPTION | BUNDLE SKU | LIST PRICE |
|-----|--|------------|-----------------|
| 1 | 8-PACK BUNDLE Includes all Components Listed Above | HMP3072PK8 | \$15,230 |

SPECIFYING EXAMPLE: Model.Laminate.Edgeband.Paint2.DuplexColor

NOTES: Typicals DO NOT include power in-feeds, screens, storage, or seating.

ADD 4 FABRIC SCREENS: \$3,212 — SEE PAGE 535

ADD 8 MOBILE PEDESTALS: \$5,304 — SEE PAGE 569

SEE PAGE 538 FOR BUNDLE SKU INFORMATION



Icon Legend on page 19

EMPOWER[®]

60"W Typicals with 30"D Worksurfaces

| QTY | DESCRIPTION | MODEL | LIST PRICE | PRICE EXTENSION |
|---------------|---|------------|----------------|-----------------|
| 2 | Worksurface, Edgeband, No Grommets 30" x 60" | HWR3060PN | \$573 | \$1,146 |
| 1 | Double Depth U-Leg (Box of 2) | HMPEL6028 | \$1,375 | \$1,375 |
| 1 | Support Beams (Box of 2) 60"W | HMPUB260 | \$700 | \$700 |
| 1 | Shared Trough 60"W | HMPROUGH60 | \$481 | \$481 |
| 1 | End of Run Electrical Kit 60"W | HMPEEK60 | \$249 | \$249 |
| 1 | Duplex 1 | HH871501 | \$47 | \$47 |
| 1 | Duplex 2 | HH871502 | \$47 | \$47 |
| 1 | Duplex 3 | HH871503 | \$47 | \$47 |
| 1 | Duplex 4 | HH871504 | \$47 | \$47 |
| TOTAL: | | | \$4,139 | |

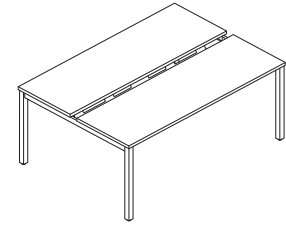

2-PACK — 60"
60"W x 63"D

| QTY | DESCRIPTION | BUNDLE SKU | LIST PRICE |
|-----|--|------------|----------------|
| 1 | 2-PACK BUNDLE Includes all Components Listed Above | HMP3060PK2 | \$4,378 |

SPECIFYING EXAMPLE: Model.Laminate.Edgeband.Paint2.DuplexColor

NOTES: Typicals DO NOT include power in-feeds, screens, storage, or seating.

ADD 1 FABRIC SCREEN: \$724 — SEE PAGE 535

ADD 2 MOBILE PEDESTALS: \$1,326 — SEE PAGE 569

SEE PAGE 538 FOR BUNDLE SKU INFORMATION

| QTY | DESCRIPTION | MODEL | LIST PRICE | PRICE EXTENSION |
|---------------|---|------------|----------------|-----------------|
| 4 | Worksurface, Edgeband, No Grommets 30" x 60" | HWR3060PN | \$573 | \$2,292 |
| 1 | Double Depth U-Leg (Box of 2) | HMPEL6028 | \$1,375 | \$1,375 |
| 1 | Double Depth Shared U-Leg (Singles) | HMPSL6028 | \$567 | \$567 |
| 2 | Support Beams (Box of 2) 60"W | HMPUB260 | \$700 | \$1,400 |
| 2 | Shared Trough 60"W | HMPROUGH60 | \$481 | \$962 |
| 1 | Power Harness 60"W | HH871260 | \$239 | \$239 |
| 1 | End of Run Electrical Kit 60"W | HMPEEK60 | \$249 | \$249 |
| 2 | Duplex 1 | HH871501 | \$47 | \$94 |
| 2 | Duplex 2 | HH871502 | \$47 | \$94 |
| 2 | Duplex 3 | HH871503 | \$47 | \$94 |
| 2 | Duplex 4 | HH871504 | \$47 | \$94 |
| TOTAL: | | | \$7,460 | |

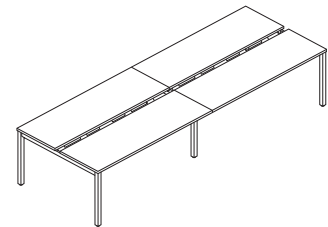

4-PACK — 60"
144"W x 63"D

| QTY | DESCRIPTION | BUNDLE SKU | LIST PRICE |
|-----|--|------------|----------------|
| 1 | 4-PACK BUNDLE Includes all Components Listed Above | HMP3060PK4 | \$7,460 |

SPECIFYING EXAMPLE: Model.Laminate.Edgeband.Paint2.DuplexColor

NOTES: Typicals DO NOT include power in-feeds, screens, storage, or seating.

ADD 2 FABRIC SCREENS: \$1,448 — SEE PAGE 535

ADD 4 MOBILE PEDESTALS: \$2,652 — SEE PAGE 569

SEE PAGE 538 FOR BUNDLE SKU INFORMATION

EMPOWER®

60"W Typicals with 30"D Worksurfaces



Icon Legend on page 19

WORKSTATIONS

| QTY | DESCRIPTION | MODEL | LIST PRICE | PRICE EXTENSION |
|---------------|---|-------------|------------|-----------------|
| 6 | Worksurface, Edgeband, No Grommets 30" x 60" | HWR3060PN | \$573 | \$3,438 |
| 1 | Double Depth U-Leg (Box of 2) | HMPEL6028 | \$1,375 | \$1,375 |
| 2 | Double Depth Shared U-Leg (Singles) | HMPSL6028 | \$567 | \$1,134 |
| 3 | Support Beams (Box of 2) 60"W | HMPUB260 | \$700 | \$2,100 |
| 3 | Shared Trough 60"W | HMPTROUGH60 | \$481 | \$1,443 |
| 2 | Power Harness 60"W | HH871260 | \$239 | \$478 |
| 1 | End of Run Electrical Kit 60"W | HMPEEK60 | \$249 | \$249 |
| 3 | Duplex 1 | HH871501 | \$47 | \$141 |
| 3 | Duplex 2 | HH871502 | \$47 | \$141 |
| 3 | Duplex 3 | HH871503 | \$47 | \$141 |
| 3 | Duplex 4 | HH871504 | \$47 | \$141 |
| TOTAL: | | | | \$10,781 |

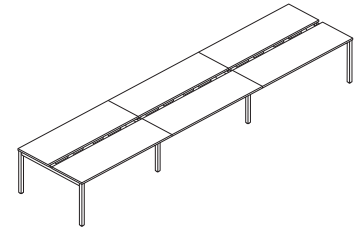

**6-PACK — 60"
180"W x 63"D**

| QTY | DESCRIPTION | BUNDLE SKU | LIST PRICE |
|-----|--|------------|-----------------|
| 1 | 6-PACK BUNDLE Includes all Components Listed Above | HMP3060PK6 | \$10,781 |

SPECIFYING EXAMPLE: Model.Laminate.Edgeband.Paint2.DuplexColor

NOTES: Typicals DO NOT include power in-feeds, screens, storage, or seating.

ADD 3 FABRIC SCREENS: \$2,172 — SEE PAGE 535

ADD 6 MOBILE PEDESTALS: \$3,978 — SEE PAGE 569

SEE PAGE 538 FOR BUNDLE SKU INFORMATION

| QTY | DESCRIPTION | MODEL | LIST PRICE | PRICE EXTENSION |
|---------------|---|-------------|------------|-----------------|
| 8 | Worksurface, Edgeband, No Grommets 30" x 60" | HWR3060PN | \$573 | \$4,584 |
| 1 | Double Depth U-Leg (Box of 2) | HMPEL6028 | \$1,375 | \$1,375 |
| 3 | Double Depth Shared U-Leg (Singles) | HMPSL6028 | \$567 | \$1,701 |
| 4 | Support Beams (Box of 2) 60"W | HMPUB260 | \$700 | \$2,800 |
| 4 | Shared Trough 60"W | HMPTROUGH60 | \$481 | \$1,924 |
| 3 | Power Harness 60"W | HH871260 | \$239 | \$717 |
| 1 | End of Run Electrical Kit 60"W | HMPEEK60 | \$249 | \$249 |
| 4 | Duplex 1 | HH871501 | \$47 | \$188 |
| 4 | Duplex 2 | HH871502 | \$47 | \$188 |
| 4 | Duplex 3 | HH871503 | \$47 | \$188 |
| 4 | Duplex 4 | HH871504 | \$47 | \$188 |
| TOTAL: | | | | \$14,102 |

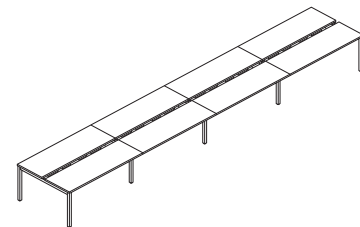

**8-PACK — 60"
240"W x 63"D**

| QTY | DESCRIPTION | BUNDLE SKU | LIST PRICE |
|-----|--|------------|-----------------|
| 1 | 8-PACK BUNDLE Includes all Components Listed Above | HMP3060PK8 | \$14,102 |

SPECIFYING EXAMPLE: Model.Laminate.Edgeband.Paint2.DuplexColor

NOTES: Typicals DO NOT include power in-feeds, screens, storage, or seating.

ADD 4 FABRIC SCREENS: \$2,896 — SEE PAGE 535

ADD 8 MOBILE PEDESTALS: \$5,304 — SEE PAGE 569

SEE PAGE 538 FOR BUNDLE SKU INFORMATION



Icon Legend on page 19

EMPOWER® 120° Workstation Typical

WORKSTATIONS

| QTY | DESCRIPTION | MODEL | LIST PRICE | PRICE EXTENSION |
|---------------|---|----------------|------------|-----------------|
| 3 | 120 Degree Corner Worksurfaces with Curved User Edge, No Grommets 48"W x 30"D | HBWCT4830PN | \$1,282 | \$3,846 |
| 3 | Double Depth U-Leg (Single Leg) | HMP120EL4828 | \$627 | \$1,881 |
| 3 | Single Post Leg 28½"H | HMP120POST | \$328 | \$984 |
| 3 | Support Beams (Box of 2) 48"W | HMP120UB248 | \$629 | \$1,887 |
| 3 | Double-Sided Trough 48"W | HMP120TROUGH48 | \$437 | \$1,311 |
| TOTAL: | | | | \$9,909 |



3-PACK – 120°

NOTES: Typicals DO NOT include power in-feeds, screens, storage, or seating.

ADD 3 FABRIC SCREENS: \$1,836 — SEE PAGE 535

ADD 3 MOBILE PEDESTALS: \$1,989 — SEE PAGE 569

| QTY | DESCRIPTION | MODEL | LIST PRICE | PRICE EXTENSION |
|---------------|---|----------------|------------|-----------------|
| 6 | 120 Degree Corner Worksurfaces with Curved User Edge, No Grommets 48"W x 30"D | HBWCT4830PN | \$1,282 | \$7,692 |
| 4 | Double Depth U-Leg (Single Leg) | HMP120EL6028 | \$689 | \$2,756 |
| 6 | Single Post Leg 28½"H | HMP120POST | \$328 | \$1,968 |
| 6 | Support Beams (Box of 2) 48"W | HMP120UB248 | \$629 | \$3,774 |
| 6 | Double-Sided Trough 48"W | HMP120TROUGH48 | \$437 | \$2,622 |
| 2 | Double Depth Shared U-Leg (Singles) | HMP120SL6028 | \$567 | \$1,134 |
| 2 | Worksurface with Edgeband 48"W x 30"D | HWR3048PN | \$481 | \$962 |
| 1 | Support Beams (Box of 2) 48"W | HMPUB248 | \$629 | \$629 |
| 1 | Double-Sided Trough 48"W | HMP120TROUGH48 | \$437 | \$437 |
| TOTAL: | | | | \$21,974 |

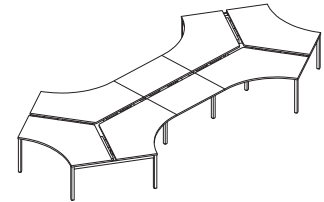

DOG BONE – 120°

NOTES: Typicals DO NOT include power in-feeds, screens, storage, or seating.

ADD 7 FABRIC SCREENS: \$4,284 — SEE PAGE 535

ADD 6 MOBILE PEDESTALS: \$3,978 — SEE PAGE 569

EMPOWER® 120° Workstation Typical



Icon Legend on page 19

WORKSTATIONS

| QTY | DESCRIPTION | MODEL | LIST PRICE | PRICE EXTENSION |
|---------------|---|----------------|------------|-----------------|
| 9 | 120 Degree Corner Worksurfaces with Curved User Edge, No Grommets 48"W x 30"D | HBWCT4830PN | \$1,282 | \$11,538 |
| 5 | Double Depth U-Leg (Single Leg) | HMP120EL4828 | \$627 | \$3,135 |
| 9 | Single Post Leg 28½"H | HMP120POST | \$328 | \$2,952 |
| 9 | Support Beams (Box of 2) 48"W | HMP120UB248 | \$629 | \$5,661 |
| 9 | Double-Sided Trough 48"W | HMP120TROUGH48 | \$437 | \$3,933 |
| 2 | Double Depth Shared U-Leg (Singles) | HMPSL4828 | \$516 | \$1,032 |
| TOTAL: | | | | \$28,251 |

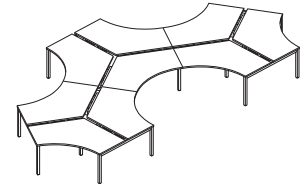

MULTIPLE PODS — 120°

NOTES: Typical DO NOT include power in-feeds, screens, storage, or seating.

ADD 9 FABRIC SCREENS: \$5,508 — SEE PAGE 535

ADD 9 MOBILE PEDESTALS: \$5,967 — SEE PAGE 569



Icon Legend on page 19

72"W Height Adjustable Typicals with 24"D Worksurfaces

| QTY | DESCRIPTION | MODEL | LIST PRICE | PRICE EXTENSION |
|---------------|---|---------------|------------|-----------------|
| 2 | Worksurface, Edgeband, No Grommets 23" x 70" | HHATW2370EM | \$583 | \$1,166 |
| 1 | Height Adjustable Base | HMPHA2S4C | \$2,518 | \$2,518 |
| 1 | Height Adjustable Shared Trough 72"W | HMPHATROUGH72 | \$528 | \$528 |
| 2 | Single-Sided Trough Lid | HMPHASLID72 | \$153 | \$306 |
| 1 | End of Run Electrical Kit 72"W | HMPEEK72 | \$249 | \$249 |
| 1 | Duplex 1 | HH871501 | \$47 | \$47 |
| 1 | Duplex 2 | HH871502 | \$47 | \$47 |
| 1 | Duplex 3 | HH871503 | \$47 | \$47 |
| 1 | Duplex 4 | HH871504 | \$47 | \$47 |
| TOTAL: | | | | \$4,955 |

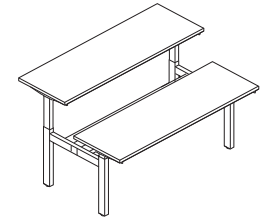
**2-PACK — 72"**
72"W x 51"D

| QTY | DESCRIPTION | BUNDLE SKU | LIST PRICE |
|-----|--|--------------|----------------|
| 1 | 2-PACK BUNDLE Includes all Components Listed Above | HMPHA2472PK2 | \$5,200 |

SPECIFYING EXAMPLE: Model.Laminate.Edgeband.BasePaint.TroughPaint.DuplexColor

NOTES: Typicals DO NOT include power in-feeds, screens, storage, or seating.

ADD 2 FABRIC SCREENS: \$1,606— SEE PAGE 535**ADD 2 MOBILE PEDESTALS: \$1,326— SEE PAGE 569****SEE PAGE 539 FOR BUNDLE SKU INFORMATION**

| QTY | DESCRIPTION | MODEL | LIST PRICE | PRICE EXTENSION |
|---------------|---|---------------|------------|-----------------|
| 4 | Worksurface, Edgeband, No Grommets 23" x 70" | HHATW2370EM | \$583 | \$2,332 |
| 2 | Height Adjustable Base | HMPHA2S4C | \$2,518 | \$5,036 |
| 2 | Height Adjustable Shared Trough 72"W | HMPHATROUGH72 | \$528 | \$1,056 |
| 4 | Single-Sided Trough Lid | HMPHASLID72 | \$153 | \$612 |
| 1 | Power Harness 72"W | HH871272 | \$239 | \$239 |
| 1 | End of Run Electrical Kit 72"W | HMPEEK72 | \$249 | \$249 |
| 2 | Duplex 1 | HH871501 | \$47 | \$94 |
| 2 | Duplex 2 | HH871502 | \$47 | \$94 |
| 2 | Duplex 3 | HH871503 | \$47 | \$94 |
| 2 | Duplex 4 | HH871504 | \$47 | \$94 |
| TOTAL: | | | | \$9,900 |

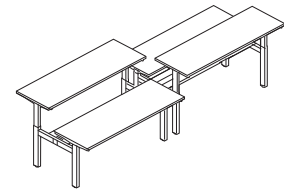
**4-PACK — 72"**
144"W x 51"D

| QTY | DESCRIPTION | BUNDLE SKU | LIST PRICE |
|-----|--|--------------|----------------|
| 1 | 4-PACK BUNDLE Includes all Components Listed Above | HMPHA2472PK4 | \$9,912 |

SPECIFYING EXAMPLE: Model.Laminate.Edgeband.BasePaint.TroughPaint.DuplexColor

NOTES: Typicals DO NOT include power in-feeds, screens, storage, or seating.

ADD 4 FABRIC SCREENS: \$3,212— SEE PAGE 535**ADD 4 MOBILE PEDESTALS: \$2,652— SEE PAGE 569****SEE PAGE 539 FOR BUNDLE SKU INFORMATION**



| QTY | DESCRIPTION | MODEL | LIST PRICE | PRICE EXTENSION |
|---------------|---|---------------|------------|-----------------|
| 6 | Worksurface, Edgeband, No Grommets 23" x 70" | HHATW237OEM | \$583 | \$3,498 |
| 3 | Height Adjustable Base | HMPHA2S4C | \$2,518 | \$7,554 |
| 3 | Height Adjustable Shared Trough 72"W | HMPHATROUGH72 | \$528 | \$1,584 |
| 6 | Single-Sided Trough Lid | HMPHASLID72 | \$153 | \$918 |
| 2 | Power Harness 72"W | HH871272 | \$239 | \$478 |
| 1 | End of Run Electrical Kit 72"W | HMPEEK72 | \$249 | \$249 |
| 3 | Duplex 1 | HH871501 | \$47 | \$141 |
| 3 | Duplex 2 | HH871502 | \$47 | \$141 |
| 3 | Duplex 3 | HH871503 | \$47 | \$141 |
| 3 | Duplex 4 | HH871504 | \$47 | \$141 |
| TOTAL: | | | | \$14,845 |

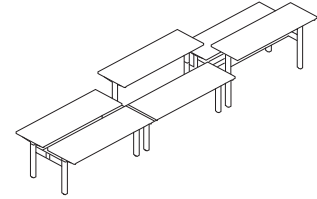

6-PACK — 72"
216"W x 51"D

| QTY | DESCRIPTION | BUNDLE SKU | LIST PRICE |
|-----|--|--------------|-----------------|
| 1 | 6-PACK BUNDLE Includes all Components Listed Above | HMPHA2472PK6 | \$14,863 |

SPECIFYING EXAMPLE: Model.Laminate.Edgeband.BasePaint.TroughPaint.DuplexColor

NOTES: Typicals DO NOT include power in-feeds, screens, storage, or seating.

ADD 6 FABRIC SCREENS: \$4,818 — SEE PAGE 535

ADD 6 MOBILE PEDESTALS: \$3,978 — SEE PAGE 569

SEE PAGE 539 FOR BUNDLE SKU INFORMATION

| QTY | DESCRIPTION | MODEL | LIST PRICE | PRICE EXTENSION |
|---------------|---|---------------|------------|-----------------|
| 8 | Worksurface, Edgeband, No Grommets 23" x 70" | HHATW237OEM | \$583 | \$4,664 |
| 4 | Height Adjustable Base | HMPHA2S4C | \$2,518 | \$10,072 |
| 4 | Height Adjustable Shared Trough 72"W | HMPHATROUGH72 | \$528 | \$2,112 |
| 8 | Single-Sided Trough Lid | HMPHASLID72 | \$153 | \$1,224 |
| 3 | Power Harness 72"W | HH871272 | \$239 | \$717 |
| 1 | End of Run Electrical Kit 72"W | HMPEEK72 | \$249 | \$249 |
| 4 | Duplex 1 | HH871501 | \$47 | \$188 |
| 4 | Duplex 2 | HH871502 | \$47 | \$188 |
| 4 | Duplex 3 | HH871503 | \$47 | \$188 |
| 4 | Duplex 4 | HH871504 | \$47 | \$188 |
| TOTAL: | | | | \$19,790 |

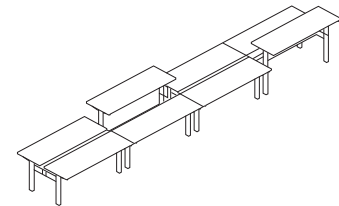

8-PACK — 72"
288"W x 51"D

| QTY | DESCRIPTION | BUNDLE SKU | LIST PRICE |
|-----|--|--------------|-----------------|
| 1 | 8-PACK BUNDLE Includes all Components Listed Above | HMPHA2472PK8 | \$19,814 |

SPECIFYING EXAMPLE: Model.Laminate.Edgeband.BasePaint.TroughPaint.DuplexColor

NOTES: Typicals DO NOT include power in-feeds, screens, storage, or seating.

ADD 8 FABRIC SCREENS: \$6,424 — SEE PAGE 535

ADD 8 MOBILE PEDESTALS: \$5,304 — SEE PAGE 569

SEE PAGE 539 FOR BUNDLE SKU INFORMATION



Icon Legend on page 19

| QTY | DESCRIPTION | MODEL | LIST PRICE | PRICE EXTENSION |
|---------------|---|---------------|------------|-----------------|
| 2 | Worksurface, Edgeband, No Grommets 23" x 58" | HHATW2358EM | \$526 | \$1,052 |
| 1 | Height Adjustable Base | HMPHA2S4C | \$2,518 | \$2,518 |
| 1 | Height Adjustable Shared Trough 60"W | HMPHATROUGH60 | \$481 | \$481 |
| 2 | Single-Sided Trough Lid | HMPHASLID60 | \$139 | \$278 |
| 1 | End of Run Electrical Kit 60"W | HMPEEK60 | \$249 | \$249 |
| 1 | Duplex 1 | HH871501 | \$47 | \$47 |
| 1 | Duplex 2 | HH871502 | \$47 | \$47 |
| 1 | Duplex 3 | HH871503 | \$47 | \$47 |
| 1 | Duplex 4 | HH871504 | \$47 | \$47 |
| TOTAL: | | | | \$4,766 |

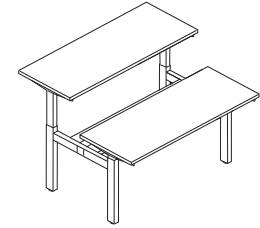
**2-PACK — 60"
60"W x 51"D**

| QTY | DESCRIPTION | BUNDLE SKU | LIST PRICE |
|-----|--|--------------|----------------|
| 1 | 2-PACK BUNDLE Includes all Components Listed Above | HMPHA2460PK2 | \$5,011 |

SPECIFYING EXAMPLE: Model.Laminate.Edgeband.BasePaint.TroughPaint.DuplexColor

NOTES: Typicals DO NOT include power in-feeds, screens, storage, or seating.

ADD 2 FABRIC SCREENS: \$1,448 — SEE PAGE 535**ADD 2 MOBILE PEDESTALS: \$1,326 — SEE PAGE 569****SEE PAGE 539 FOR BUNDLE SKU INFORMATION**

| QTY | DESCRIPTION | MODEL | LIST PRICE | PRICE EXTENSION |
|---------------|---|---------------|------------|-----------------|
| 4 | Worksurface, Edgeband, No Grommets 23" x 58" | HHATW2358EM | \$526 | \$2,104 |
| 2 | Height Adjustable Base | HMPHA2S4C | \$2,518 | \$5,036 |
| 2 | Height Adjustable Shared Trough 60"W | HMPHATROUGH60 | \$481 | \$962 |
| 4 | Single-Sided Trough Lid | HMPHASLID60 | \$139 | \$556 |
| 1 | Power Harness 60"W | HH871260 | \$239 | \$239 |
| 1 | End of Run Electrical Kit 60"W | HMPEEK60 | \$249 | \$249 |
| 2 | Duplex 1 | HH871501 | \$47 | \$94 |
| 2 | Duplex 2 | HH871502 | \$47 | \$94 |
| 2 | Duplex 3 | HH871503 | \$47 | \$94 |
| 2 | Duplex 4 | HH871504 | \$47 | \$94 |
| TOTAL: | | | | \$9,522 |

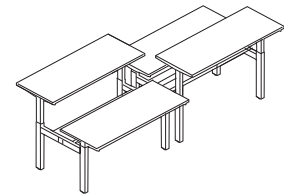
**4-PACK — 60"
120"W x 51"D**

| QTY | DESCRIPTION | BUNDLE SKU | LIST PRICE |
|-----|--|--------------|----------------|
| 1 | 4-PACK BUNDLE Includes all Components Listed Above | HMPHA2460PK4 | \$9,534 |

SPECIFYING EXAMPLE: Model.Laminate.Edgeband.BasePaint.TroughPaint.DuplexColor

NOTES: Typicals DO NOT include power in-feeds, screens, storage, or seating.

ADD 4 FABRIC SCREENS: \$2,896 — SEE PAGE 535**ADD 4 MOBILE PEDESTALS: \$2,652 — SEE PAGE 569****SEE PAGE 539 FOR BUNDLE SKU INFORMATION**



| QTY | DESCRIPTION | MODEL | LIST PRICE | PRICE EXTENSION |
|---------------|---|---------------|------------|-----------------|
| 6 | Worksurface, Edgeband, No Grommets 23" x 58" | HHATW2358EM | \$526 | \$3,156 |
| 3 | Height Adjustable Base | HMPHA2S4C | \$2,518 | \$7,554 |
| 3 | Height Adjustable Shared Trough 60"W | HMPHATROUGH60 | \$481 | \$1,443 |
| 6 | Single-Sided Trough Lid | HMPHASLID60 | \$139 | \$834 |
| 2 | Power Harness 60"W | HH871260 | \$239 | \$478 |
| 1 | End of Run Electrical Kit 60"W | HMPEEK60 | \$249 | \$249 |
| 3 | Duplex 1 | HH871501 | \$47 | \$141 |
| 3 | Duplex 2 | HH871502 | \$47 | \$141 |
| 3 | Duplex 3 | HH871503 | \$47 | \$141 |
| 3 | Duplex 4 | HH871504 | \$47 | \$141 |
| TOTAL: | | | | \$14,278 |

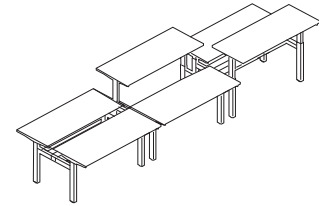

6-PACK — 60"
180"W x 51"D

| QTY | DESCRIPTION | BUNDLE SKU | LIST PRICE |
|-----|--|--------------|-----------------|
| 1 | 6-PACK BUNDLE Includes all Components Listed Above | HMPHA2460PK6 | \$14,296 |

SPECIFYING EXAMPLE: Model.Laminate.Edgeband.BasePaint.TroughPaint.DuplexColor

NOTES: Typicals DO NOT include power in-feeds, screens, storage, or seating.

ADD 6 FABRIC SCREENS: \$4,344 — SEE PAGE 535

ADD 6 MOBILE PEDESTALS: \$3,978 — SEE PAGE 569

SEE PAGE 539 FOR BUNDLE SKU INFORMATION

| QTY | DESCRIPTION | MODEL | LIST PRICE | PRICE EXTENSION |
|---------------|---|---------------|------------|-----------------|
| 8 | Worksurface, Edgeband, No Grommets 23" x 58" | HHATW2358EM | \$526 | \$4,208 |
| 4 | Height Adjustable Base | HMPHA2S4C | \$2,518 | \$10,072 |
| 4 | Height Adjustable Shared Trough 60"W | HMPHATROUGH60 | \$481 | \$1,924 |
| 8 | Single-Sided Trough Lid | HMPHASLID60 | \$139 | \$1,112 |
| 3 | Power Harness 60"W | HH871260 | \$239 | \$717 |
| 1 | End of Run Electrical Kit 60"W | HMPEEK60 | \$249 | \$249 |
| 4 | Duplex 1 | HH871501 | \$47 | \$188 |
| 4 | Duplex 2 | HH871502 | \$47 | \$188 |
| 4 | Duplex 3 | HH871503 | \$47 | \$188 |
| 4 | Duplex 4 | HH871504 | \$47 | \$188 |
| TOTAL: | | | | \$19,034 |

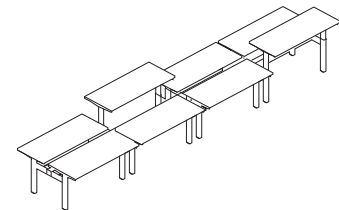

8-PACK — 60"
240"W x 51"D

| QTY | DESCRIPTION | BUNDLE SKU | LIST PRICE |
|-----|--|--------------|-----------------|
| 1 | 8-PACK BUNDLE Includes all Components Listed Above | HMPHA2460PK8 | \$19,058 |

SPECIFYING EXAMPLE: Model.Laminate.Edgeband.BasePaint.TroughPaint.DuplexColor

NOTES: Typicals DO NOT include power in-feeds, screens, storage, or seating.

ADD 8 FABRIC SCREENS: \$5,792 — SEE PAGE 535

ADD 8 MOBILE PEDESTALS: \$5,304 — SEE PAGE 569

SEE PAGE 539 FOR BUNDLE SKU INFORMATION



Icon Legend on page 19

72"W Height Adjustable Typicals with 30"D Worksurfaces

| QTY | DESCRIPTION | MODEL | LIST PRICE | PRICE EXTENSION |
|---------------|---|---------------|------------|-----------------|
| 2 | Worksurface, Edgeband, No Grommets 29" x 70" | HHATW2970EM | \$653 | \$1,306 |
| 1 | Height Adjustable Base | HMPHA2S4C | \$2,518 | \$2,518 |
| 1 | Height Adjustable Shared Trough 72"W | HMPHATROUGH72 | \$528 | \$528 |
| 2 | Single-Sided Trough Lid | HMPHASLID72 | \$153 | \$306 |
| 1 | End of Run Electrical Kit 72"W | HMPEEK72 | \$249 | \$249 |
| 1 | Duplex 1 | HH871501 | \$47 | \$47 |
| 1 | Duplex 2 | HH871502 | \$47 | \$47 |
| 1 | Duplex 3 | HH871503 | \$47 | \$47 |
| 1 | Duplex 4 | HH871504 | \$47 | \$47 |
| TOTAL: | | | | \$5,095 |

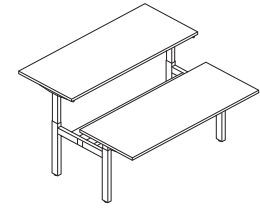
**2-PACK — 72"
72"W x 63"D**

| QTY | DESCRIPTION | BUNDLE SKU | LIST PRICE |
|-----|--|--------------|----------------|
| 1 | 2-PACK BUNDLE Includes all Components Listed Above | HMPHA3072PK2 | \$5,334 |

SPECIFYING EXAMPLE: Model.Laminate.Edgeband.BasePaint.TroughPaint.DuplexColor

NOTES: Typicals DO NOT include power in-feeds, screens, storage, or seating.

ADD 2 FABRIC SCREENS: \$1,606 — SEE PAGE 535

ADD 2 MOBILE PEDESTALS: \$1,326 — SEE PAGE 569

SEE PAGE 539 FOR BUNDLE SKU INFORMATION

| QTY | DESCRIPTION | MODEL | LIST PRICE | PRICE EXTENSION |
|---------------|---|---------------|------------|-----------------|
| 4 | Worksurface, Edgeband, No Grommets 29" x 70" | HHATW2970EM | \$653 | \$2,612 |
| 2 | Height Adjustable Base | HMPHA2S4C | \$2,518 | \$5,036 |
| 2 | Height Adjustable Shared Trough 72"W | HMPHATROUGH72 | \$528 | \$1,056 |
| 4 | Single-Sided Trough Lid | HMPHASLID72 | \$153 | \$612 |
| 1 | Power Harness 72"W | HH871272 | \$239 | \$239 |
| 1 | End of Run Electrical Kit 72"W | HMPEEK72 | \$249 | \$249 |
| 2 | Duplex 1 | HH871501 | \$47 | \$94 |
| 2 | Duplex 2 | HH871502 | \$47 | \$94 |
| 2 | Duplex 3 | HH871503 | \$47 | \$94 |
| 2 | Duplex 4 | HH871504 | \$47 | \$94 |
| TOTAL: | | | | \$10,180 |

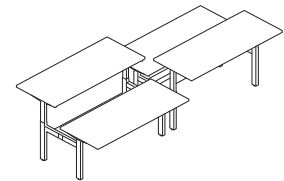
**4-PACK — 72"
144"W x 63"D**

| QTY | DESCRIPTION | BUNDLE SKU | LIST PRICE |
|-----|--|--------------|-----------------|
| 1 | 4-PACK BUNDLE Includes all Components Listed Above | HMPHA3072PK4 | \$10,180 |

SPECIFYING EXAMPLE: Model.Laminate.Edgeband.BasePaint.TroughPaint.DuplexColor

NOTES: Typicals DO NOT include power in-feeds, screens, storage, or seating.

ADD 4 FABRIC SCREENS: \$3,212 — SEE PAGE 535

ADD 4 MOBILE PEDESTALS: \$2,652 — SEE PAGE 569

SEE PAGE 539 FOR BUNDLE SKU INFORMATION



| QTY | DESCRIPTION | MODEL | LIST PRICE | PRICE EXTENSION |
|---------------|---|---------------|------------|-----------------|
| 6 | Worksurface, Edgeband, No Grommets 29" x 70" | HHATW297OEM | \$653 | \$3,918 |
| 3 | Height Adjustable Base | HMPHA2S4C | \$2,518 | \$7,554 |
| 3 | Height Adjustable Shared Trough 72"W | HMPHATROUGH72 | \$528 | \$1,584 |
| 6 | Single-Sided Trough Lid | HMPHASLID72 | \$153 | \$918 |
| 2 | Power Harness 72"W | HH871272 | \$239 | \$478 |
| 1 | End of Run Electrical Kit 72"W | HMPEEK72 | \$249 | \$249 |
| 3 | Duplex 1 | HH871501 | \$47 | \$141 |
| 3 | Duplex 2 | HH871502 | \$47 | \$141 |
| 3 | Duplex 3 | HH871503 | \$47 | \$141 |
| 3 | Duplex 4 | HH871504 | \$47 | \$141 |
| TOTAL: | | | | \$15,265 |

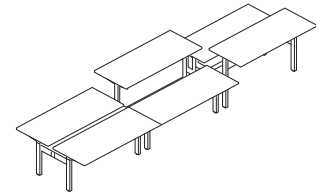

**6-PACK — 72"
216"W x 63"D**

| QTY | DESCRIPTION | BUNDLE SKU | LIST PRICE |
|-----|--|--------------|-----------------|
| 1 | 6-PACK BUNDLE Includes all Components Listed Above | HMPHA3072PK6 | \$15,265 |

SPECIFYING EXAMPLE: Model.Laminate.Edgeband.BasePaint.TroughPaint.DuplexColor

NOTES: Typicals DO NOT include power in-feeds, screens, storage, or seating.

ADD 6 FABRIC SCREENS: \$4,818 — SEE PAGE 535

ADD 6 MOBILE PEDESTALS: \$3,978 — SEE PAGE 569

SEE PAGE 539 FOR BUNDLE SKU INFORMATION

| QTY | DESCRIPTION | MODEL | LIST PRICE | PRICE EXTENSION |
|---------------|---|---------------|------------|-----------------|
| 8 | Worksurface, Edgeband, No Grommets 29" x 70" | HHATW297OEM | \$653 | \$5,224 |
| 4 | Height Adjustable Base | HMPHA2S4C | \$2,518 | \$10,072 |
| 4 | Height Adjustable Shared Trough 72"W | HMPHATROUGH72 | \$528 | \$2,112 |
| 8 | Single-Sided Trough Lid | HMPHASLID72 | \$153 | \$1,224 |
| 3 | Power Harness 72"W | HH871272 | \$239 | \$717 |
| 1 | End of Run Electrical Kit 72"W | HMPEEK72 | \$249 | \$249 |
| 4 | Duplex 1 | HH871501 | \$47 | \$188 |
| 4 | Duplex 2 | HH871502 | \$47 | \$188 |
| 4 | Duplex 3 | HH871503 | \$47 | \$188 |
| 4 | Duplex 4 | HH871504 | \$47 | \$188 |
| TOTAL: | | | | \$20,350 |

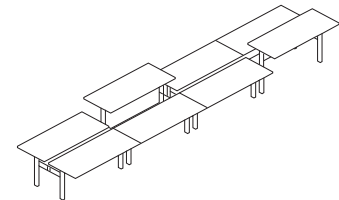

**8-PACK — 72"
288"W x 63"D**

| QTY | DESCRIPTION | BUNDLE SKU | LIST PRICE |
|-----|--|--------------|-----------------|
| 1 | 8-PACK BUNDLE Includes all Components Listed Above | HMPHA3072PK8 | \$20,350 |

SPECIFYING EXAMPLE: Model.Laminate.Edgeband.BasePaint.TroughPaint.DuplexColor

NOTES: Typicals DO NOT include power in-feeds, screens, storage, or seating.

ADD 8 FABRIC SCREENS: \$6,424 — SEE PAGE 535

ADD 8 MOBILE PEDESTALS: \$5,304 — SEE PAGE 569

SEE PAGE 539 FOR BUNDLE SKU INFORMATION



Icon Legend on page 19

| QTY | DESCRIPTION | MODEL | LIST PRICE | PRICE EXTENSION |
|---------------|---|---------------|------------|-----------------|
| 2 | Worksurface, Edgeband, No Grommets 29" x 58" | HHATW2958EM | \$573 | \$1,146 |
| 1 | Height Adjustable Base | HMPHA2S4C | \$2,518 | \$2,518 |
| 1 | Height Adjustable Shared Trough 60"W | HMPHATROUGH60 | \$481 | \$481 |
| 2 | Single-Sided Trough Lid | HMPHASLID60 | \$139 | \$278 |
| 1 | End of Run Electrical Kit 60"W | HMPEEK60 | \$249 | \$249 |
| 1 | Duplex 1 | HH871501 | \$47 | \$47 |
| 1 | Duplex 2 | HH871502 | \$47 | \$47 |
| 1 | Duplex 3 | HH871503 | \$47 | \$47 |
| 1 | Duplex 4 | HH871504 | \$47 | \$47 |
| TOTAL: | | | | \$4,860 |

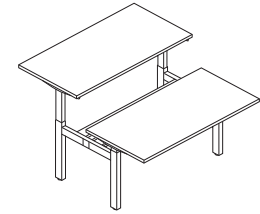
**2-PACK — 60"
60"W x 63"D**

| QTY | DESCRIPTION | BUNDLE SKU | LIST PRICE |
|-----|--|--------------|----------------|
| 1 | 2-PACK BUNDLE Includes all Components Listed Above | HMPHA3060PK2 | \$5,107 |

SPECIFYING EXAMPLE: Model.Laminate.Edgeband.BasePaint.TroughPaint.DuplexColor

NOTES: Typicals DO NOT include power in-feeds, screens, storage, or seating.

ADD 2 FABRIC SCREENS: \$1,448 — SEE PAGE 535**ADD 2 MOBILE PEDESTALS: \$1,326 — SEE PAGE 569****SEE PAGE 539 FOR BUNDLE SKU INFORMATION**

| QTY | DESCRIPTION | MODEL | LIST PRICE | PRICE EXTENSION |
|---------------|---|---------------|------------|-----------------|
| 4 | Worksurface, Edgeband, No Grommets 29" x 58" | HHATW2958EM | \$573 | \$2,292 |
| 2 | Height Adjustable Base | HMPHA2S4C | \$2,518 | \$5,036 |
| 2 | Height Adjustable Shared Trough 60"W | HMPHATROUGH60 | \$481 | \$962 |
| 4 | Single-Sided Trough Lid | HMPHASLID60 | \$139 | \$556 |
| 1 | Power Harness 60"W | HH871260 | \$239 | \$239 |
| 1 | End of Run Electrical Kit 60"W | HMPEEK60 | \$249 | \$249 |
| 2 | Duplex 1 | HH871501 | \$47 | \$94 |
| 2 | Duplex 2 | HH871502 | \$47 | \$94 |
| 2 | Duplex 3 | HH871503 | \$47 | \$94 |
| 2 | Duplex 4 | HH871504 | \$47 | \$94 |
| TOTAL: | | | | \$9,710 |

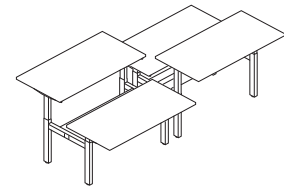
**4-PACK — 60"
120"W x 63"D**

| QTY | DESCRIPTION | BUNDLE SKU | LIST PRICE |
|-----|--|--------------|----------------|
| 1 | 4-PACK BUNDLE Includes all Components Listed Above | HMPHA3060PK4 | \$9,726 |

SPECIFYING EXAMPLE: Model.Laminate.Edgeband.BasePaint.TroughPaint.DuplexColor

NOTES: Typicals DO NOT include power in-feeds, screens, storage, or seating.

ADD 4 FABRIC SCREENS: \$2,896 — SEE PAGE 535**ADD 4 MOBILE PEDESTALS: \$2,652 — SEE PAGE 569****SEE PAGE 539 FOR BUNDLE SKU INFORMATION**



| QTY | DESCRIPTION | MODEL | LIST PRICE | PRICE EXTENSION |
|---------------|---|---------------|------------|-----------------|
| 6 | Worksurface, Edgeband, No Grommets 29" x 58" | HHATW2958EM | \$573 | \$3,438 |
| 3 | Height Adjustable Base | HMPHA2S4C | \$2,518 | \$7,554 |
| 3 | Height Adjustable Shared Trough 60"W | HMPHATROUGH60 | \$481 | \$1,443 |
| 6 | Single-Sided Trough Lid | HMPHASLID60 | \$139 | \$834 |
| 2 | Power Harness 60"W | HH871260 | \$239 | \$478 |
| 1 | End of Run Electrical Kit 60"W | HMPEEK60 | \$249 | \$249 |
| 3 | Duplex 1 | HH871501 | \$47 | \$141 |
| 3 | Duplex 2 | HH871502 | \$47 | \$141 |
| 3 | Duplex 3 | HH871503 | \$47 | \$141 |
| 3 | Duplex 4 | HH871504 | \$47 | \$141 |
| TOTAL: | | | | \$14,560 |

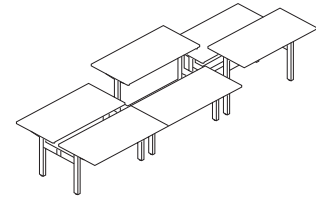

**6-PACK — 60"
180"W x 63"D**

| QTY | DESCRIPTION | BUNDLE SKU | LIST PRICE |
|-----|--|--------------|-----------------|
| 1 | 6-PACK BUNDLE Includes all Components Listed Above | HMPHA3060PK6 | \$14,584 |

SPECIFYING EXAMPLE: Model.Laminate.Edgeband.BasePaint.TroughPaint.DuplexColor

NOTES: Typicals DO NOT include power in-feeds, screens, storage, or seating.

ADD 6 FABRIC SCREENS: \$4,344 — SEE PAGE 535

ADD 6 MOBILE PEDESTALS: \$3,978 — SEE PAGE 569

SEE PAGE 539 FOR BUNDLE SKU INFORMATION

| QTY | DESCRIPTION | MODEL | LIST PRICE | PRICE EXTENSION |
|---------------|---|---------------|------------|-----------------|
| 8 | Worksurface, Edgeband, No Grommets 29" x 58" | HHATW2958EM | \$573 | \$4,584 |
| 4 | Height Adjustable Base | HMPHA2S4C | \$2,518 | \$10,072 |
| 4 | Height Adjustable Shared Trough 60"W | HMPHATROUGH60 | \$481 | \$1,924 |
| 8 | Single-Sided Trough Lid | HMPHASLID60 | \$139 | \$1,112 |
| 3 | Power Harness 60"W | HH871260 | \$239 | \$717 |
| 1 | End of Run Electrical Kit 60"W | HMPEEK60 | \$249 | \$249 |
| 4 | Duplex 1 | HH871501 | \$47 | \$188 |
| 4 | Duplex 2 | HH871502 | \$47 | \$188 |
| 4 | Duplex 3 | HH871503 | \$47 | \$188 |
| 4 | Duplex 4 | HH871504 | \$47 | \$188 |
| TOTAL: | | | | \$19,410 |

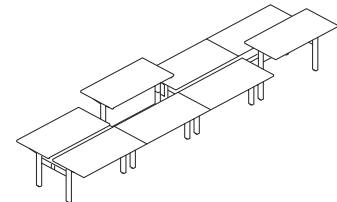

**8-PACK — 60"
240"W x 63"D**

| QTY | DESCRIPTION | BUNDLE SKU | LIST PRICE |
|-----|--|--------------|-----------------|
| 1 | 8-PACK BUNDLE Includes all Components Listed Above | HMPHA3060PK8 | \$19,442 |

SPECIFYING EXAMPLE: Model.Laminate.Edgeband.BasePaint.TroughPaint.DuplexColor

NOTES: Typicals DO NOT include power in-feeds, screens, storage, or seating.

ADD 8 FABRIC SCREENS: \$5,792 — SEE PAGE 535

ADD 8 MOBILE PEDESTALS: \$5,304 — SEE PAGE 569

SEE PAGE 539 FOR BUNDLE SKU INFORMATION

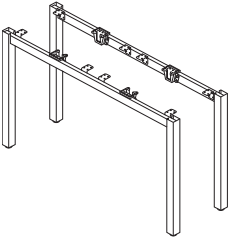
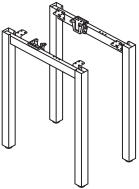
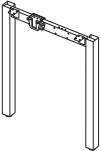

EMPOWER® Legs for Linear Applications

| | DESCRIPTION | MODEL | SHIP WEIGHT | CUBE | LIST PRICE BY PAINT GRADE | | |
|---|--|--|--------------|--------------|--------------------------------|--------------------------------|--------------------------------|
| | | | | | P1 | P2 | P3 |
|  | Double Depth U-Leg (Box of 2) 50½"D for use with 24"D Worksurfaces 62½"D for use with 30"D Worksurfaces NOTES: Ships as a box of 2 legs. | HMPPEL4828 ☉ HMPPEL6028 | 32.4 34.8 | 14.9 18.5 | \$1251 \$1375 | \$1255 \$1379 | \$1285 \$1412 |
| | Double Depth Shared U-Leg (Singles) 30"D for use with 24"D Worksurfaces 42"D for use with 30"D Worksurfaces | HMPPSL4828 ☉ HMPPSL6028 | 21.1 22.5 | 4.9 6.4 | \$516 \$567 | \$520 \$571 | \$530 \$582 |
|  | Single Depth U-Leg (Box of 2) 24"D for use with 24"D Worksurfaces 30"D for use with 30"D Worksurfaces | HMPPEL2428 HMPPEL3028 | 23.7 24.9 | 7.6 9.4 | \$625 \$689 | \$629 \$693 | \$653 \$720 |
| | Single Depth Shared U-Leg (Singles) 18"D for use with 24"D Worksurfaces 24"D for use with 30"D Worksurfaces | HMPPSL2428 HMPPSL3028 | 14.8 15.6 | 3.2 4.0 | \$381 \$419 | \$385 \$423 | \$398 \$438 |
|  | Single Depth Return U-Leg (Singles) Left Right NOTES: Return U-Legs ship with two flat brackets. | HMPPREL2428 HMPPREL2428 | 23.7 23.7 | 4.0 4.0 | \$381 \$381 | \$385 \$385 | \$398 \$398 |

HOW TO SPECIFY

| | |
|---|--|
| Select Model Number H M P E L 4 8 2 8 | Select Paint Color See page 504 T 1 |
|---|--|

EMPOWER® Legs for 120° Applications

GSA SIN 33721



Icon Legend on page 19

WORKSTATIONS

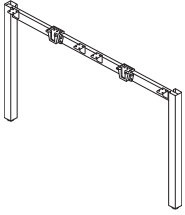

| DESCRIPTION | MODEL | SHIP WEIGHT | CUBE | LIST PRICE BY PAINT GRADE | | |
|--|---------------------|-------------|------|---------------------------|--------------|--------------|
| | | | | P1 | P2 | P3 |
| Double Depth U-Leg (Single Leg for 120° Applications) 50½"D for use with 24"D Worksurfaces | HMP120EL4828 | 19 | 7.9 | \$627 | \$631 | \$655 |
| 60½"D for use with 30"D Worksurfaces | HMP120EL6028 | 20 | 9.6 | \$689 | \$693 | \$720 |

NOTES: Ships as single leg for 120 degree applications.

! 120 degree surfaces must be used in back-to-back applications — cannot be used freestanding.

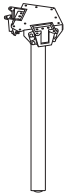

| DESCRIPTION | MODEL | SHIP WEIGHT | CUBE | P1 | P2 | P3 |
|--|-------------------|-------------|------|--------------|--------------|--------------|
| Post Leg for 120° Applications (Singles) 28½"H | HMP120POST | 10 | 1.4 | \$328 | \$332 | \$343 |

NOTES: One post leg needed per 120 degree worksurface. Post leg ships with attachment brackets needed to connect support beams and worksurfaces.

! 120 degree surfaces must be used in back-to-back applications — cannot be used freestanding.

| Worksurface Width | Electrical Model | Quantity |
|-------------------|------------------|----------|
| 36" | HH871124 | 1 |
| 36" | HH871148 | 2 |
| 42" | HH871124 | 1 |
| 42" | HH871160 | 2 |
| 48" | HH871124 | 1 |
| 48" | HH871172 | 2 |

HOW TO SPECIFY

| | |
|--|--|
| <p>Select Model Number</p> <p>HMP120EL4828 . T1</p> | <p>Select Paint Color</p> <p>See page 504</p> |
|--|--|



EMPOWER[®]

Support Beams

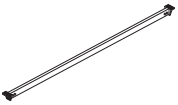
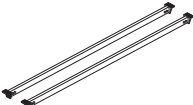
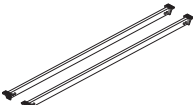
| | DESCRIPTION | MODEL | SHIP WEIGHT | CUBE | LIST PRICE |
|---|--|--------------------|-------------|------|--------------|
|  | Support Beams (Box of 1) | | | | |
| | 48"W | HMPUB148 | 7.0 | 0.5 | \$315 |
| | 60"W | HMPUB160 | 8.3 | 0.7 | \$352 |
| | 72"W | HMPUB172 | 9.6 | 0.9 | \$390 |
| | NOTES: One support beam per worksurface is needed. | | | | |
| | ! Available in graphite finish only. No specification needed. | | | | |
|  | Support Beams (Box of 2) | | | | |
| | 48"W | HMPUB248 | 13.3 | 0.5 | \$629 |
| | 60"W | HMPUB260 © | 15.8 | 0.7 | \$700 |
| | 72"W | HMPUB272 | 18.2 | 0.9 | \$775 |
| | NOTES: For use with double-sided stations. One support beam per worksurface is needed. | | | | |
| | ! Available in graphite finish only. No specification needed. | | | | |
|  | Support Beams for 120° Applications (Box of 2) | | | | |
| | 36"W | HMP120UB236 | 7.8 | 0.9 | \$499 |
| | 42"W | HMP120UB242 | 9.5 | 0.9 | \$561 |
| | 48"W | HMP120UB248 | 11.0 | 0.9 | \$629 |
| | NOTES: Two support beams per 120 degree worksurface are needed. | | | | |
| | ! Available in graphite finish only. No specification needed. | | | | |

NOTES:

- For use with stationary, single-sided stations. 36"W returns will use the 48"W Support Beam and 48"W returns will use the 60"W Support Beam.

HOW TO SPECIFY

Select
Model Number

H M P 1 2 0 U B 2 3 6

EMPOWER® Wire Troughs

GSA SIN 33721



Icon Legend on page 19

WORKSTATIONS

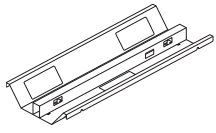

DESCRIPTION

Trough — Double-Sided

48"W
60"W
72"W

! Available in graphite finish only. No specification needed.

MODEL

HMPTROUGH48
HMPTROUGH60
HMPTROUGH72

SHIP WEIGHT

3.3
4.3
5.3

CUBE

5.3
6.8
8.3

LIST PRICE

\$437
\$481
\$528

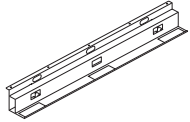

Trough — Single-Sided

48"W
60"W
72"W

! Available in graphite finish only. No specification needed.

HMPSTROUGH48
HMPSTROUGH60
HMPSTROUGH72

3.0
4.0
5.0

5.3
6.8
8.3

\$327
\$444
\$561

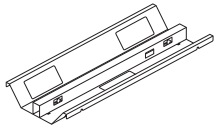

Trough — Double-Sided for 120° Applications

36"W
42"W
48"W

! Available in graphite finish only. No specification needed.

HMP120TROUGH36
HMP120TROUGH42
HMP120TROUGH48

6.9
8.4
9.9

3.8
3.8
5.3

\$356
\$394
\$437

NEW!

NOTES:

- Slots available in trough to zip tie data cables to the trough.
- Double-sided wire trough rests on top of support bars. No fasteners needed.
- Single-sided trough is used for single-sided applications only. Screws into bottom side of worksurface for attachment.

! For use with stationary Empower® only.

HOW TO SPECIFY

Select
Model Number

H M P T R O U G H 4 8



EMPOWER® Return Components

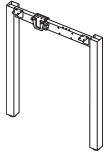

DESCRIPTION

Single Depth Return Leg (Singles)

Left
Right

NOTES: Return legs ship with two flat brackets.

| MODEL | SHIP WEIGHT | CUBE | LIST PRICE BY PAINT GRADE | | |
|------------|-------------|------|---------------------------|-------|-------|
| | | | P1 | P2 | P3 |
| HMPREL2428 | 23.7 | 4.0 | \$381 | \$385 | \$398 |
| HMPREL2428 | 23.7 | 4.0 | \$381 | \$385 | \$398 |

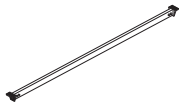

DESCRIPTION

Support Beams (Box of 1)

48"W
60"W

NOTES: For use with single-sided stations. 36"W returns will use the 48"W Support Beam and 48"W returns will use the 60"W Support Beam.

ⓘ Available in graphite finish only. No specification needed.

| MODEL | SHIP WEIGHT | CUBE | LIST PRICE |
|----------|-------------|------|------------|
| HMPUB148 | 7.0 | 0.5 | \$315 |
| HMPUB160 | 8.3 | 0.7 | \$352 |

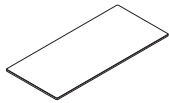

DESCRIPTION

24"D Worksurface with Edgeband

36"W x 24"D

NOTES: For use as a return surface only.

48"W x 24"D

NOTES: Can be used as a primary surface or a return surface.

| MODEL | SHIP WEIGHT | CUBE | LIST PRICE BY LAMINATE GRADE | |
|-----------|-------------|------|------------------------------|-------|
| | | | L1 | L2 |
| HWR2436PN | 46 ⓘ | 2.5 | \$382 | \$397 |
| HWR2448PN | 58 ⓘ | 3.3 | \$446 | \$461 |

NOTES:

- Worksurfaces are constructed of laminate on 1/8" solid core high-performance particleboard.
- Return legs ship with two flat brackets. 36"W returns will use the 48"W Support Beam and 48"W returns will use the 60"W Support Beam.
- ⓘ All worksurfaces load tested to BIFMA standards.
- ⓘ Stack-on storage cannot be used on Empower® benching.
- ⓘ For use with static linear applications only.

HOW TO SPECIFY

| | | |
|--|--|--|
| <p>Select Model Number</p> <p>H M P R L E L 2 4 2 8 .</p> | <p>Select Paint Color</p> <p>See page 504</p> <p>T 1</p> | |
| <p>Select Model Number</p> <p>H W R 2 4 3 6 P N .</p> | <p>Select Laminate Color</p> <p>See page 504</p> <p>L D W 1 .</p> | <p>Select Edgeband Color</p> <p>See page 504</p> <p>L D W 1</p> |







EMPOWER[®] Systems Worksurfaces

GSA SIN 33721

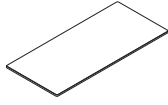

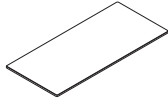

Icon Legend on page 19

WORKSTATIONS

| | DESCRIPTION | MODEL | SHIP WEIGHT | CUBE | LIST PRICE BY LAMINATE GRADE | |
|--|--|--|---|------|------------------------------|--------------|
| | | | | | L1 | L2 |
|  | 24"D Worksurface with Edgeband | | | | | |
| | 48"W x 24"D | HWR2448PN | 58  | 3.3 | \$446 | \$461 |
| | NOTES: Can be used as a primary surface or a return surface. | | | | | |
| | 60"W x 24"D | HWR2460PN  | 70 | 4.0 | \$526 | \$546 |
| | 72"W x 24"D | HWR2472PN | 89 | 4.8 | \$583 | \$603 |
| | NOTES: For use as a primary surface. | | | | | |
|  | 30"D Worksurface with Edgeband | | | | | |
| | 48"W x 30"D | HWR3048PN  | 58  | 3.3 | \$481 | \$496 |
| | 60"W x 30"D | HWR3060PN  | 70 | 4.0 | \$573 | \$593 |
| | 72"W x 30"D | HWR3072PN | 89 | 4.8 | \$653 | \$673 |

NOTES:

- Worksurfaces are constructed of laminate on 1/8" solid core high-performance particleboard.
-  All worksurfaces load tested to BIFMA standards.
-  Stack-on storage cannot be used on Empower[®] benching.
-  Height adjustable worksurfaces are reduced 2" in width and 0.75" in depth to prevent pinch points.

HOW TO SPECIFY

| | | |
|--|---|---|
| <p>Select Model Number</p> <p>HWR2448PN</p> | <p>Select Laminate Color</p> <p>See page 504</p> <p>LDW1</p> | <p>Select Edgeband Color</p> <p>See page 504</p> <p>LDW1</p> |
|--|---|---|



SYSTEMS WORKSURFACES

120 Degree Corner

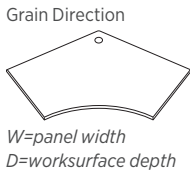

DESCRIPTION

Abound® and Accelerate® 120 Degree Corner Worksurfaces with Curved User Edge

36"W x 24"D
42"W x 24"D
48"W x 24"D

MODEL

HBWCT3624P
HBWCT4224P
HBWCT4824P

SHIP WEIGHT

75
96
107

CUBE

7.7
9.2
9.2

L1 LIST PRICE

\$856
\$917
\$1063

L2 LIST PRICE

\$871
\$932
\$1078

42"W x 30"D
48"W x 30"D

HBWCT4230P
HBWCT4830P

102
112

11.4
11.4

\$1205
\$1282

\$1220
\$1297

- HBWCT3624P will not accept the H4022, HE4022, H4028, or H4029 keyboard platforms.
- One small worksurface bracket standard with each worksurface.

❗ Corner worksurfaces must match exactly the panel behind them, i.e.: a 36" panel must be used on the back two sides of model HBWCT3624P.

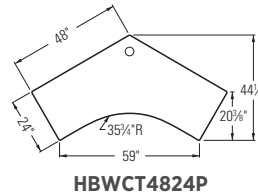
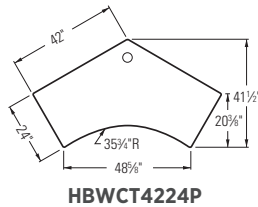
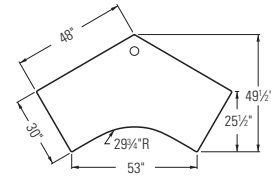
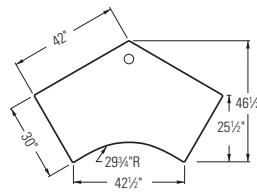
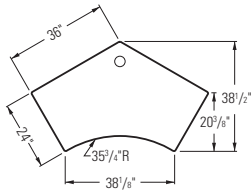

NOTES:

- Worksurfaces are constructed of laminate on 1/8" solid core high-performance particleboard.
- Add suffix "N" to Model Number for worksurfaces with no grommets. No upcharge.
- Refer to Worksurface Supports, pages 630-634.
- If used at an end of run, full end panel needs to be ordered — see page 630.

- ❗ Cannot use keyboard tray or full height pedestal under 120 degree corner worksurface.
- ❗ For use with linear applications only.

HOW TO SPECIFY

| | | | |
|---|---|---|--|
| <p>Select Model Number</p> <p>No Grommet option: Add "N" suffix (no upcharge)</p> <p>HBWCT3624P .</p> <p>HBWCT3624PN .</p> | <p>Select Laminate</p> <p>See page 481</p> <p>AS .</p> <p>AS .</p> | <p>Select Edge Color</p> <p>See page 481</p> <p>K .</p> <p>K .</p> | <p>Select Grommet Color</p> <p>See page 481</p> <p>T1</p> |
|---|---|---|--|

EMPOWER® Height Adjustable Bases

GSA SIN 33721 EXCEPT AS NOTED

Icon Legend on page 19

WORKSTATIONS

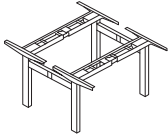

OPEN MARKET



DESCRIPTION

Height Adjustable Base
Back-to-Back Workstation

MODEL

HMPHA2S4C

SHIP WEIGHT

130

CUBE

5.3

LIST PRICE

\$2518

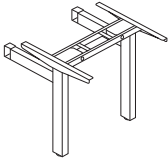

OPEN MARKET



End of Run Kit

! End of Run Kit needs to be attached to one side of HMPHA2S4C. End of Run Kit cannot stand on its own.

HMPHABEORKIT

15

3.1

\$194

NOTES:

• Bases are steel construction with telescoping horizontal frame that adjusts from 41"-71"W to accommodate 42"-72"W worksurfaces. Memory controller features four memory presets, programmable upper and lower limit, and keypad lock to prevent unintentional movement. Dour motor with 250 lbs. load capacity per surface. Travel range of 19 5/8" adjustment from 25 5/8" to 45 1/4" (excluding worksurface dimension).

! Height adjustable benching cannot be single-sided; must always be used in back to back layouts.

! HBSMAUSB and HBDMAUSB cannot be used in Empower® height adjustable applications.

DESCRIPTION

Trough for Height Adjustable Base — Double-Sided
48"W
60"W
72"W

MODEL

HMPHATROUGH48
HMPHATROUGH60 ©
HMPHATROUGH72

SHIP WEIGHT

5.0
6.5
7.0

CUBE

1.7
2.2
2.7

LIST PRICE

\$437
\$481
\$528

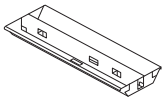

Trough for Height Adjustable End of Run
20"W

HMPHATROUGH20

3.0

0.4

\$353

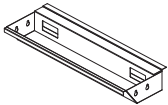

Single-Sided Trough Lid — Single Pack

For 48"W Trough
For 60"W Trough
For 72"W Trough
For Height Adjustable Base 20"W End of Run Trough

HMPHASLID48
HMPHASLID60 ©
HMPHASLID72
HMPHASLID20

3.0
4.0
5.0
2.0

0.4
0.5
0.6
0.4

\$128
\$139
\$153
\$103

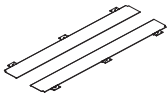

NOTES:

- Slots available in trough to zip tie data cables to the trough.
- Trough attaches to crossbeam connected to the height adjustable columns.
- 2 trough lids needed per double-sided trough.
- 1 trough lid needed for end of run trough.
- \$4 upcharge for P2 Paints.
- \$10 upcharge for P3 Paints on Trough Covers and End of Run Trough.
- \$20 upcharge for P3 Paints on Troughs.

HOW TO SPECIFY

| | |
|---|--|
| <p>Select Model Number</p> <p>H M P H A 2 S 4 C .</p> | <p>Select Paint Color</p> <p>P71 Black P8L Nickel PD8 White</p> <p>P 8 L</p> |
|---|--|

| | |
|---|--|
| <p>Select Model Number</p> <p>H M P H A T R O U G H 4 8 .</p> | <p>Select Paint Color</p> <p>See page 504</p> <p>P 8 S</p> |
|---|--|



EMPOWER[®] Systems Worksurfaces

| | DESCRIPTION | MODEL | SHIP WEIGHT | CUBE | LIST PRICE BY LAMINATE GRADE | |
|--|---------------------------------------|--------------------|-------------|------|------------------------------|--------------|
| | | | | | L1 | L2 |
| | 23"D Worksurface with Edgeband | | | | | |
| | 46"W x 23"D | HHATW2346EM | 58 | 3.1 | \$446 | \$461 |
| | 58"W x 23"D | HHATW2358EM | 70 | 3.9 | \$526 | \$546 |
| | 70"W x 23"D | HHATW2370EM | 89 | 4.6 | \$583 | \$603 |
| | 29"D Worksurface with Edgeband | | | | | |
| | 46"W x 29"D | HHATW2946EM | 68 | 3.9 | \$481 | \$496 |
| | 58"W x 29"D | HHATW2958EM | 101 | 4.8 | \$573 | \$593 |
| | 70"W x 29"D | HHATW2970EM | 105 | 5.7 | \$653 | \$673 |

NOTES:

- Worksurfaces are constructed of laminate on 1 1/8" solid core high-performance particleboard.
- ❗ All worksurfaces load tested to BIFMA standards.
- ❗ Stack-on storage cannot be used on Empower[®] benching.
- ❗ Height adjustable worksurfaces are reduced 2" in width and 0.75" in depth to prevent pinch points.

HOW TO SPECIFY

| | | |
|--|---|---|
| <p>Select Model Number</p> <p>HHATW2346EM</p> | <p>Select Laminate Color</p> <p>See page 504</p> <p>WHIT</p> | <p>Select Edgeband Color</p> <p>See page 504</p> <p>WHIT</p> |
|--|---|---|

EMPOWER[®] Side Screens

GSA SIN 33721



Icon Legend on page 19

WORKSTATIONS

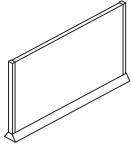

DESCRIPTION

Fabric Side Screen

24"D x 13"H
24"D x 20"H

30"D x 13"H
30"D x 20"H

MODEL

HMPDFS2413
HMPDFS2420

HMPDFS3013
HMPDFS3020

SHIP WEIGHT CUBE

4.5 2.1
4.5 1.6

5.0 1.9
5.0 2.2

LIST PRICE BY FABRIC GRADE

AA A B

\$439 \$459 \$479
\$485 \$505 \$525

\$484 \$504 \$524
\$534 \$554 \$574

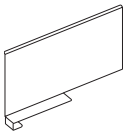

DESCRIPTION

Painted Metal Side Screen

24"D x 13"H
30"D x 13"H

MODEL

HMPDMS2413
HMPDMS3013

SHIP WEIGHT CUBE

6.3 2.0
7.7 2.8

LIST PRICE BY PAINT GRADE

P1 P2 P3

\$309 \$313 \$329
\$356 \$360 \$376

NOTES:

- Fabric screen adheres to the top of the worksurface with heavy-duty double stick tape.
- Metal screen slides over the edge of the worksurface and screws in under the worksurface.
- Metal screen is available in markerboard paint.
- For use on stationary and height adjustable setups.

HOW TO SPECIFY

| | | |
|---|--|--|
| Select Model Number H M P D F S 2 4 1 3 | Select Paint Color See page 504 T 1 | Select Fabric See pages 502-503 A P N 1 1 |
|---|--|--|

| | |
|---|--|
| Select Model Number H M P D M S 2 4 1 3 | Select Paint Color See page 504 P 8 S |
|---|--|



EMPOWER[®] Center Screens Fabric

WORKSTATIONS

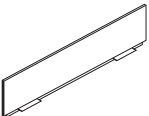
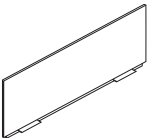
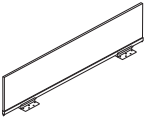
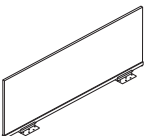
| DESCRIPTION | MODEL | SHIP WEIGHT | CUBE | LIST PRICE BY FABRIC GRADE | | | |
|---|--|---------------------|------|----------------------------|-------|-------|-------|
| | | | | AA | A | B | |
|  Fabric Screens (Shared) — 13”H 24”W 30”W 36”W 42”W 48”W 60”W ⓘ For use on stationary stations only. | HMPCFS2413 | 6.3 | 0.9 | \$332 | \$352 | \$372 | |
| | HMPCFS3013 | 7.3 | 1.1 | \$411 | \$431 | \$451 | |
| | HMPCFS3613 | 8.3 | 1.4 | \$501 | \$521 | \$541 | |
| | HMPCFS4213 | 9.3 | 1.6 | \$516 | \$536 | \$556 | |
| | HMPCFS4813 | 10.3 | 1.8 | \$636 | \$656 | \$676 | |
| | HMPCFS6013 | 12.3 | 2.3 | \$732 | \$752 | \$772 | |
| |  Fabric Screens (Shared) — 20”H 24”W 30”W 36”W 42”W 48”W 60”W ⓘ For use on stationary stations only. | HMPCFS2420 | 7.3 | 1.6 | \$422 | \$442 | \$462 |
| | | HMPCFS3020 | 8.5 | 1.6 | \$524 | \$544 | \$564 |
| | | HMPCFS3620 | 9.8 | 2.1 | \$637 | \$657 | \$677 |
| | | HMPCFS4220 | 11.0 | 2.4 | \$612 | \$632 | \$652 |
| HMPCFS4820 | | 12.3 | 2.8 | \$724 | \$744 | \$764 | |
| HMPCFS6020 | | 14.8 | 3.5 | \$803 | \$823 | \$843 | |
|  Fabric Screens (Single) — 13”H 36”W 42”W 48”W 54”W 60”W NOTES: For use on single-sided stationary stations or height adjustable stations (one per worksurface). | | HMPFSS3613 | 9.7 | 2.4 | \$495 | \$515 | \$535 |
| | | HMPFSS4213 | 11.0 | 1.7 | \$510 | \$530 | \$550 |
| | | HMPFSS4813 ⓘ | 12.3 | 2.9 | \$630 | \$650 | \$670 |
| | | HMPFSS5413 ⓘ | 13.6 | 2.4 | \$662 | \$682 | \$702 |
| | HMPFSS6013 ⓘ | 14.8 | 3.6 | \$726 | \$746 | \$766 | |
| |  Fabric Screens (Single) — 20”H 36”W 42”W 48”W 54”W 60”W NOTES: For use on single-sided stationary stations or height adjustable stations (one per worksurface). | HMPFSS3620 | 11.2 | 3.2 | \$631 | \$651 | \$671 |
| HMPFSS4220 | | 12.8 | 2.7 | \$606 | \$626 | \$646 | |
| HMPFSS4820 | | 14.3 | 4.0 | \$718 | \$738 | \$758 | |
| HMPFSS5420 | | 15.9 | 3.6 | \$752 | \$772 | \$792 | |
| HMPFSS6020 | | 17.3 | 4.9 | \$797 | \$817 | \$837 | |

NOTES:

- ⓘ Only single-sided screens can be specified with height adjustable workstations.
- ⓘ When using a power pole, the screen on the station with the pole must be 6” shorter to allow space for the pole to be mounted.

Fabric Screen Specifying Guide

| Static Rectangle Worksurface Width | Inset 6” on Each Side | Full Length |
|------------------------------------|-----------------------|-------------|
| 48” | 36” | 48” |
| 60” | 48” | 60” |
| 72” | 60” | N/A |

| 120 Side Width | Inset 6” on Each Side | Full Length |
|----------------|-----------------------|-------------|
| 36” | 24” | 36” |
| 42” | 30” | 42” |
| 48” | 36” | 48” |

| Height Adjustable Rectangle Worksurface Width | Inset 5” on Each Side | Inset 2” on Each Side |
|---|-----------------------|-----------------------|
| 48” (undersized) | 36” | 42” |
| 60” (undersized) | 48” | 54” |
| 72” (undersized) | 60” | N/A |

HOW TO SPECIFY

| | | |
|--|--|---|
| <p>Select Model Number</p> <p>H M P C F S 3 6 2 0 .</p> | <p>Select Paint Color</p> <p>See page 504 \$4 upcharge for P2 Paints \$20 upcharge for P3 Paints</p> <p>T 1 .</p> | <p>Select Fabric</p> <p>See pages 502-503</p> <p>A P N 1 1</p> |
|--|--|---|

EMPOWER® Center Screens Frosted Glass

GSA SIN 33721



Icon Legend on page 19

WORKSTATIONS

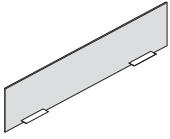

DESCRIPTION

Frosted Glass Screens (Shared) — 13”H

| MODEL | SHIP WEIGHT | CUBE | LIST PRICE BY PAINT GRADE | | |
|-------|-------------|------|---------------------------|-------|-------|
| | | | P1 | P2 | |
| 24”W | HMPFG2413 | 18.2 | 1.4 | \$365 | \$369 |
| 30”W | HMPFG3013 | 21.0 | 1.6 | \$452 | \$456 |
| 36”W | HMPFG3613 | 23.8 | 1.9 | \$549 | \$553 |
| 42”W | HMPFG4213 | 26.5 | 2.2 | \$569 | \$573 |
| 48”W | HMPFG4813 | 29.3 | 2.4 | \$671 | \$675 |
| 60”W | HMPFG6013 | 35.3 | 3.0 | \$804 | \$808 |
| 72”W | HMPFG7213 | 43.3 | 3.5 | \$883 | \$887 |

! For use on stationary stations only.

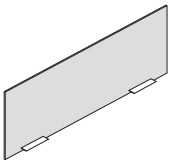

Frosted Glass Screens (Shared) — 20”H

| | | | | | |
|------|-----------|------|-----|-------|-------|
| 24”W | HMPFG2420 | 24.8 | 2.0 | \$463 | \$467 |
| 30”W | HMPFG3020 | 28.8 | 2.4 | \$576 | \$580 |
| 36”W | HMPFG3620 | 32.8 | 2.8 | \$671 | \$675 |
| 42”W | HMPFG4220 | 37.3 | 3.1 | \$672 | \$676 |
| 48”W | HMPFG4820 | 41.3 | 3.5 | \$794 | \$798 |
| 60”W | HMPFG6020 | 49.3 | 4.3 | \$882 | \$886 |
| 72”W | HMPFG7220 | 60.3 | 5.1 | \$969 | \$973 |

! For use on stationary stations only.

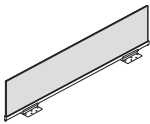

Frosted Glass Screens (Single) — 13”H

| | | | | | |
|------|------------|------|-----|-------|-------|
| 36”W | HMPFGS3613 | 25.2 | 1.9 | \$543 | \$547 |
| 42”W | HMPFGS4213 | 28.3 | 2.2 | \$563 | \$567 |
| 48”W | HMPFGS4813 | 31.3 | 2.4 | \$665 | \$669 |
| 54”W | HMPFGS5413 | 34.4 | 2.8 | \$728 | \$732 |
| 60”W | HMPFGS6013 | 37.8 | 3.0 | \$798 | \$802 |
| 72”W | HMPFGS7213 | 46.3 | 3.5 | \$877 | \$881 |

NOTES: For use on single-sided stationary stations or height adjustable stations (one per worksurface).

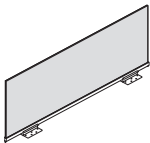

Frosted Glass Screens (Single) — 20”H

| | | | | | |
|------|------------|------|-----|-------|-------|
| 36”W | HMPFGS3620 | 34.2 | 2.8 | \$665 | \$669 |
| 42”W | HMPFGS4220 | 38.8 | 3.1 | \$666 | \$670 |
| 48”W | HMPFGS4820 | 43.3 | 3.5 | \$788 | \$792 |
| 54”W | HMPFGS5420 | 47.9 | 3.8 | \$829 | \$833 |
| 60”W | HMPFGS6020 | 51.8 | 4.3 | \$876 | \$880 |
| 72”W | HMPFGS7220 | 63.3 | 5.1 | \$963 | \$967 |

NOTES: For use on single-sided stationary stations or height adjustable stations (one per worksurface).

! 20”H glass cannot be used on 24”D single-sided stations.

NOTES:

- ! Only single-sided screens can be specified with height adjustable workstations.
- ! When using a power pole, the screen on the station with the pole must be 6” shorter to allow space for the pole to be mounted.

Glass Screen Specifying Guide

| Rectangle Worksurface Width | Inset 6” on Each Side | Full Length |
|-----------------------------|-----------------------|-------------|
| 48” | 36” | 48” |
| 60” | 48” | 60” |
| 72” | 60” | 72” |

| 120 Side Width | Inset 6” on Each Side | Full Length |
|----------------|-----------------------|-------------|
| 36” | 24” | 36” |
| 42” | 30” | 42” |
| 48” | 36” | 48” |

| Height Adjustable Rectangle Worksurface Width | Inset 5” on Each Side | Inset 2” on Each Side |
|---|-----------------------|-----------------------|
| 48” (undersized) | 36” | 42” |
| 60” (undersized) | 48” | 54” |
| 72” (undersized) | 60” | N/A |

HOW TO SPECIFY

| | | |
|--|--|---|
| Select Model Number <input type="text" value="HMPFG3613"/> | Select Paint Color See page 504 <input type="text" value="T1"/> | Select Frosted Glass <input type="text" value="R"/> |
|--|--|---|



Modesty Panels/End of Run Screens

| | DESCRIPTION | MODEL | SHIP WEIGHT | CUBE | LIST PRICE BY LAMINATE GRADE | |
|--|---|-------------------|-------------|------|------------------------------|--------------|
| | | | | | L1 | L2 |
| | Laminate Modesty Panels — 13”H | | | | | |
| | 36”W for use with 48”W Worksurfaces | HMPLM3613 | 12.9 | 1.9 | \$202 | \$212 |
| | 48”W for use with 60”W Worksurfaces | HMPLM4813 | 16.9 | 2.4 | \$303 | \$313 |
| | 60”W for use with 72”W Worksurfaces | HMPLM6013 | 19.9 | 2.9 | \$344 | \$354 |
| | NOTES: Vertical grain. | | | | | |
| | ! For use on single-sided stationary Empower® only. | | | | | |
| | Single-Side Laminate End of Run Screens | | | | | |
| | Single — 24”W x 26”H | HMPLM2426 | 16.9 | 2.2 | \$205 | \$215 |
| | Single — 24”W x 34”H | HMPLM2434 | 20.9 | 2.8 | \$225 | \$235 |
| | Single — 30”W x 26”H | HMPLM3026 | 20.5 | 2.7 | \$233 | \$243 |
| | Single — 30”W x 34”H | HMPLM3034 | 25.5 | 3.4 | \$257 | \$267 |
| | NOTES: 24”W and 48”W models used on 24”D Worksurfaces and 30”W and 60”W models are used on 30”D Worksurfaces. Vertical grain. | | | | | |
| | Double-Side Laminate End of Run Screens | | | | | |
| | Double — 48”W x 26”H | HMPLM4826 | 30.9 | 4.1 | \$300 | \$310 |
| | Double — 48”W x 34”H | HMPLM4834 | 38.9 | 5.2 | \$328 | \$338 |
| | Double — 60”W x 26”H | HMPLM6026 | 38.1 | 5.1 | \$405 | \$415 |
| | Double — 60”W x 34”H | HMPLM6034 | 48.3 | 6.4 | \$439 | \$449 |
| | NOTES: 24”W and 48”W models used on 24”D Worksurfaces and 30”W and 60”W models are used on 30”D Worksurfaces. Vertical grain. | | | | | |
| | Double-Side Laminate Gallery Panel for Height Adjustable | | | | | |
| | 48”W x 50”H | HMPLGP4850 | 82.0 | 6.6 | \$679 | \$689 |
| | 60”W x 50”H | HMPLGP6050 | 100.0 | 9.2 | \$752 | \$762 |
| | NOTES: Horizontal grain. | | | | | |

NOTES:

- End of run screens sit -1” inset on each side of the depth of the run.
- Static end of run screens are 13” below the surface and either 13”H or 20”H above the surface.
- Height adjustable end of run screens extend to the floor and are 50”H.

HOW TO SPECIFY

| | | |
|--|---|---|
| <p>Select Model Number</p> <p>HMPLM3613</p> | <p>Select Laminate Color</p> <p>See page 504</p> <p>PINCPINC</p> | <p>Select Paint Color</p> <p>Bracket paint must be specified</p> <p>T1</p> |
|--|---|---|

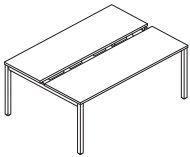
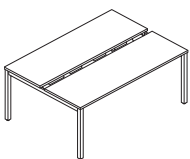
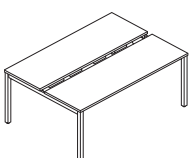
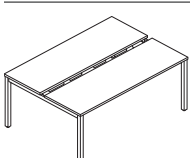
| | DESCRIPTION | MODEL | SHIP WEIGHT | CUBE | LIST PRICE BY LAMINATE GRADE | |
|---|--|-------------------|-------------|-------|------------------------------|----------------|
| | | | | | L1 | L2 |
|  | Bundles — 72"W with 24"D Worksurfaces | | | | | |
| | 2-Pack | HMP2472PK2 | 238.9 | 35.3 | \$4396 | \$4436 |
| | 4-Pack | HMP2472PK4 | 465.8 | 59.4 | \$7569 | \$7649 |
| | 6-Pack | HMP2472PK6 | 692.7 | 83.9 | \$10981 | \$11101 |
| | 8-Pack | HMP2472PK8 | 919.6 | 108.5 | \$14393 | \$14553 |
|  | Bundles — 60"W with 24"D Worksurfaces | | | | | |
| | 2-Pack | HMP2460PK2 | 198.9 | 35.3 | \$4409 | \$4449 |
| | 4-Pack | HMP2460PK4 | 385.8 | 59.4 | \$7097 | \$7177 |
| | 6-Pack | HMP2460PK6 | 572.7 | 83.9 | \$10273 | \$10393 |
| | 8-Pack | HMP2460PK8 | 759.6 | 108.5 | \$13449 | \$13609 |
|  | Bundles — 72"W with 30"D Worksurfaces | | | | | |
| | 2-Pack | HMP3072PK2 | 238.9 | 35.3 | \$4660 | \$4700 |
| | 4-Pack | HMP3072PK4 | 465.8 | 59.4 | \$8024 | \$8104 |
| | 6-Pack | HMP3072PK6 | 692.7 | 83.9 | \$11627 | \$11747 |
| | 8-Pack | HMP3072PK8 | 919.6 | 108.5 | \$15230 | \$15390 |
|  | Bundles — 60"W with 30"D Worksurfaces | | | | | |
| | 2-Pack | HMP3060PK2 | 198.9 | 35.3 | \$4378 | \$4418 |
| | 4-Pack | HMP3060PK4 | 385.8 | 59.4 | \$7460 | \$7540 |
| | 6-Pack | HMP3060PK6 | 572.7 | 83.9 | \$10781 | \$10901 |
| | 8-Pack | HMP3060PK8 | 759.6 | 108.5 | \$14102 | \$14262 |
| SPECIFYING EXAMPLE: Model.Laminate.Edgeband.Paint2.DuplexColor (S only) | | | | | | |

NOTES:

- Bundles include worksurfaces, support legs, support bars, wire management troughs, harnesses, and duplexes.
- Please specify in-feed, screens, storage, and seating separately.

ⓘ Stack-on storage cannot be used on Empower benching.

HOW TO SPECIFY

| | | | | |
|---|---|---|--|--|
| <p>Select Model Number</p> <p>HMP2472PK2</p> | <p>Select Laminate Color</p> <p>See page 504</p> <p>LDW1</p> | <p>Select Edgeband Color</p> <p>See page 504</p> <p>LDW1</p> | <p>Select Paint Color</p> <p>See page 504</p> <p>\$4 upcharge for P2 Paints</p> <p>T1</p> | <p>Select Duplex Color</p> <p>See page 504</p> <p>S</p> |
|---|---|---|--|--|



EMPOWER® Height Adjustable Typicals

| | DESCRIPTION | MODEL | SHIP WEIGHT | CUBE | LIST PRICE BY LAMINATE GRADE | |
|--|--|---------------------|-------------|------|------------------------------|----------------|
| | | | | | L1 | L2 |
| | Bundles — 72" W with 24" D Worksurfaces | | | | | |
| | 2-Pack | HMPHA2472PK2 | 331 | 19.1 | \$5200 | \$5240 |
| | 4-Pack | HMPHA2472PK4 | 662 | 37.6 | \$9912 | \$9992 |
| | 6-Pack | HMPHA2472PK6 | 993 | 56.2 | \$14863 | \$14983 |
| | 8-Pack | HMPHA2472PK8 | 1324 | 74.7 | \$19814 | \$19974 |
| | Bundles — 60" W with 24" D Worksurfaces | | | | | |
| | 2-Pack | HMPHA2460PK2 | 291 | 16.9 | \$5011 | \$5051 |
| | 4-Pack | HMPHA2460PK4 | 581 | 33.1 | \$9534 | \$9614 |
| | 6-Pack | HMPHA2460PK6 | 872 | 49.4 | \$14296 | \$14416 |
| | 8-Pack | HMPHA2460PK8 | 1162 | 65.7 | \$19058 | \$19218 |
| | Bundles — 72" W with 30" D Worksurfaces | | | | | |
| | 2-Pack | HMPHA3072PK2 | 363 | 21.3 | \$5334 | \$5374 |
| | 4-Pack | HMPHA3072PK4 | 726 | 41.9 | \$10180 | \$10260 |
| | 6-Pack | HMPHA3072PK6 | 1089 | 62.6 | \$15265 | \$15385 |
| | 8-Pack | HMPHA3072PK8 | 1452 | 83.3 | \$20350 | \$20510 |
| | Bundles — 60" W with 30" D Worksurfaces | | | | | |
| | 2-Pack | HMPHA3060PK2 | 353 | 18.7 | \$5107 | \$5147 |
| | 4-Pack | HMPHA3060PK4 | 705 | 36.7 | \$9726 | \$9806 |
| | 6-Pack | HMPHA3060PK6 | 1058 | 54.8 | \$14584 | \$14704 |
| | 8-Pack | HMPHA3060PK8 | 1410 | 72.9 | \$19442 | \$19602 |

SPECIFYING EXAMPLE: Model.Laminate.Edgeband.BasePaint.TroughPaint.DuplexColor

NOTES:

- Bundles include worksurfaces, wire management troughs, trough covers, harnesses, duplexes, and bases.
- Please specify in-feed, screens, storage, and seating separately.

- ! Stack-on storage cannot be used on Empower benching.
- ! HBSMAUSB and HBDMAUSB cannot be used in Empower® height adjustable applications.

HOW TO SPECIFY

| | | | | | |
|----------------------------|------------------------------|------------------------------|---|----------------------------------|----------------------------|
| Select Model Number | Select Laminate Color | Select Edgeband Color | Select Base Paint Color | Select Trough Paint Color | Select Duplex Color |
| | See page 504 | See page 504 | See page 504 Upcharge for P2 and P3 Paints | See page 504 | See page 504 |
| H M P H A 2 4 7 2 P K 2 . | L D W 1 . | L D W 1 . | T 1 . | S . | S . |

EMPOWER[®] ELECTRICAL SPECIFYING INFORMATION

To Order:

- Determine which electrical system you will use after consulting your electrician and computer support personnel:
 - The Four-circuit system (4-Hot/2-Neutral/2-Ground)**
 - 3 + 1 option
 - 2 + 2 option
 - The Three-circuit system (3-Hot/3-Neutral/2-Ground)**
 - Determine location, quantity and circuit of duplexes.
 - Determine the appropriate choice and use of Isolated, Isolated/Dedicated and Separate Neutral circuits.
 - Specify appropriate Power Harnesses* and Pass-Thru Cables.*
 - Determine the location, quantity and type of Power In-feed needed.
- * Select Power Harness models (HH8712XX) and Pass-Thru Cables (HH8711XX) with the last two digits being the same as the associated worksurface width.

Electrical System Options

The four-circuit, eight-wire electrical system is widely specified and trusted by hundreds of thousands of end-users. This proven system delivers four circuits for every power in-feed in either a 3 + 1 or 2 + 2 configuration. The isolated/dedicated circuits are ideal for sensitive computing equipment, while the common circuits are suitable for faxes, copiers, task lights and other peripherals.

Both the 3 + 1 and 2 + 2 systems use the same pre-wired components, making it easy to adjust as electrical needs change.

You can also choose a three-circuit, eight-wire system that has a dedicated neutral for every hot circuit. The three-circuit components have model numbers with an "A" suffix and appear in a gray box in this pricer.

Four-circuit, 3 + 1 Receptacle Option

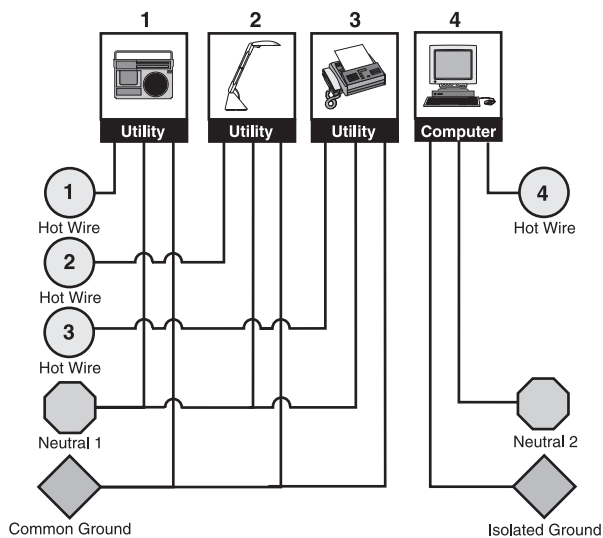

The 3 + 1 option is the electrical standard used by The HON Company for many years in most of their systems products. This wiring option provides three utility circuits plus an isolated/dedicated circuit for more sensitive equipment.

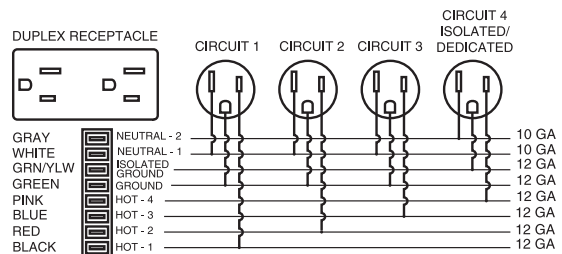

Four-circuit, 2 + 2 Receptacle Option

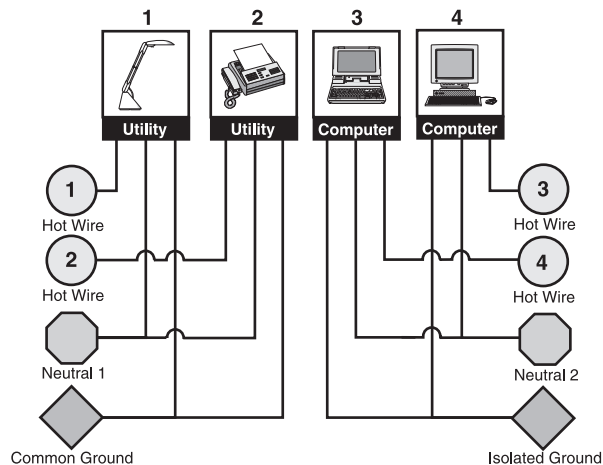

The 2 + 2 option is a wiring option that provides two utility circuits and two isolated circuits for more extensive computer usage applications.

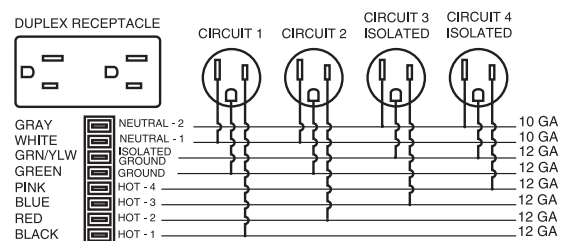

EMPOWER[®] ELECTRICAL SPECIFYING INFORMATION

Three-circuit, separate neutrals

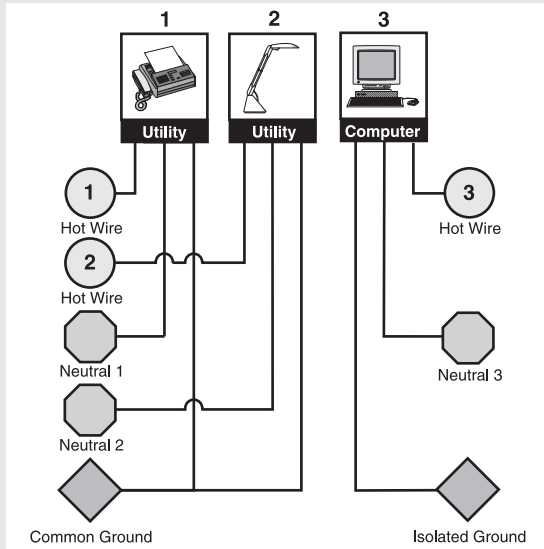

The Three-circuit, separate neutrals configuration is a wiring option that provides separate neutrals for each of the three circuits. Two circuits share a common ground, and one circuit is isolated/dedicated. The three-circuit components have model numbers with an "A" suffix and appear in a gray box in this pricer.

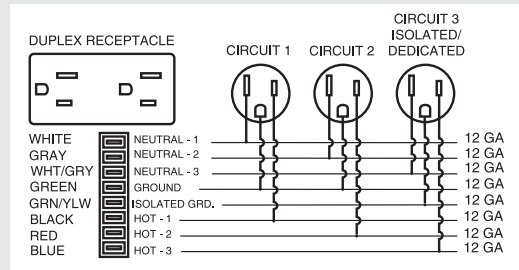

| Two 8-wire, 20 AMP (15 AMP Canadian) electrical systems are offered | | | | | |
|--|---------------------|--------------------------------------|---|---|--|
| Electrical System | Circuitry | Receptacle Capacity | | | |
| Four-circuit 4-Hot/2-Neutral/2-Ground (10 gauge neutral wires) | 3 + 1 | Common Circuit-1 HH873501 | Common Circuit-2 (1) HH873502 | Common Circuit-3 HH873503 | Iso/Dedicated Circuit-4 HH873504 |
| | 2 + 2 | Common Circuit-1 HH873501 | Common Circuit-2 HH873502 | Isolated Circuit-3 HH873506 | Isolated Circuit-4 HH873504 |
| Three-circuit 3-Hot/3-Neutral/2-Ground (12 gauge neutral wires) | w/separate neutrals | Common Circuit-1 HH873501A | Common Circuit-2 HH873502A | Iso/Dedicated Circuit-3 HH873503A | N/A |

(1) Circuit-2 (one of the 3 common circuits sharing a neutral wire) cannot be used with a single-phase building electrical supply.

Notes:

- Four-circuit components and three-circuit components (with suffix "A") cannot be used together.
- Components of the two systems are keyed differently to prevent components of one system from being connected to components of another system.
- HON Cat. Nos. are printed on the UL labels, and components are color-coded to provide visual identification of the different components.
- Four-circuit components have black plastic parts.
- Three-circuit components have rust-colored terminal ends and receptacle backs are rust colored.

Typical power usage by the most commonly specified office equipment.

Source: Industry Analysis, Inc., Rochester, NY

| EQUIPMENT | AMPS | EQUIPMENT | AMPS | EQUIPMENT | AMPS |
|-------------------|------|------------------------|-------------|---------------------|-------------|
| Computers | | Copiers | | FAX Machines | |
| Personal Computer | 3 | Desktop Copier | 15 | InkJet FAX | less than 1 |
| Notebook Computer | 3 | Console Copier | 20 | Thermal FAX | less than 1 |
| | | Copier/Duplicator | 30 | Plain paper FAX | 8 |
| Monitors | | Printers | | Task Lights | |
| 13" Color Monitor | 2 | Dot Matrix | less than 1 | 36" T8 Fluorescent | 0.2/bulb |
| 17" Color Monitor | 3 | InkJet | less than 1 | 48" T8 Fluorescent | 0.3/bulb |
| 21" Color Monitor | 4 | Personal Laser or LED | 8 | | |
| | | Workgroup Laser or LED | 15 | | |

Duplex Receptacles



15 AMP Receptacle

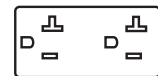

20 AMP Receptacle
(Required by some large copiers.)

EMPOWER[®] ELECTRICAL SPECIFYING INFORMATION

- Electrical components are UL Listed and CSA Certified.
- It is the customer's responsibility to ensure that use of the pre-wired electrical system, the number of receptacles used on a given circuit, and connection to a building power source, be in compliance with all local and national electrical codes.
- Contact Customer Service for additional information.
- Four-circuit components and Three-circuit components (with suffix "A") cannot be used together. See pages 540-541.
- ! A licensed electrician must make connections to a building electrical supply.

Definition of components:

Electrical Power Harness



- Used to distribute power in workstations.
- Power distribution in either direction.
- Specify Power Harness to match workstation width.
- Double-sided: receptacles can be inserted into both sides of Power Blocks.

Electrical Pass-Thru Cables

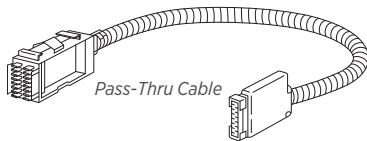

- Pass-Thru Cable With Duplex Capacity:
- Use in workstations where multiple receptacles are not required.
 - Added feature: has capacity for one receptacle on each side of a workstation. Feature offers future expansion and is an alternative to Power Harnesses.

Duplex Receptacles

- 15 amp outlet configuration.
- Models HH871601 and HH871601A have a 20 amp outlet configuration.
- Fit back-to-back into the Power Block(s) of Power and Pass-Thru Harnesses.
- Labeled with the provided circuit. Circuits connected to the Isolated Ground are identified with an orange triangle; circuits that do not share a neutral or ground have an orange circuit number.

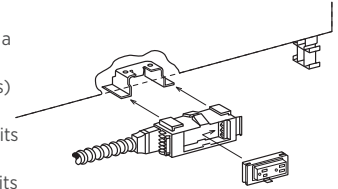

Power In-Feed Model (Floor or Ceiling) HMP144

- Used to connect the workstation electrical system to the building electrical supply.
- ! A licensed electrician must make connections to a building electrical supply.
- ! Conduit is UL listed Black Liquid-tight conduit (outside diameter is 7/8").



Note: In-feed cables listed above may be field-cut to desired length.

3-Pack 120 Degree Electric Specification Guide

| | A | B |
|-----------------|----------|----------|
| 36" 120 surface | HH871124 | HH871148 |
| 42" 120 surface | HH871124 | HH871160 |
| 48" 120 surface | HH871124 | HH871172 |

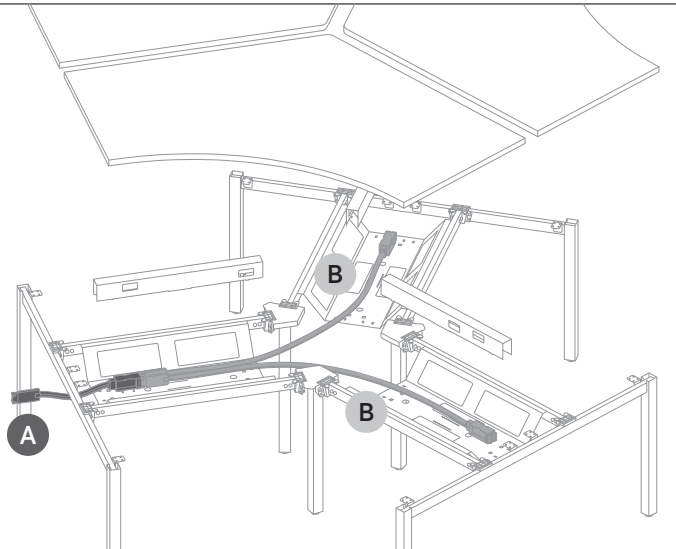

EMPOWER[®] ELECTRICAL SPECIFYING INFORMATION

- Electrical components are UL Listed and CSA Certified.
- It is the customer's responsibility to ensure that use of the pre-wired electrical system, the number of receptacles used on a given circuit, and connection to a building power source, be in compliance with all local and national electrical codes.
- ! A licensed electrician must make connections to a building electrical supply.

Vertebrae:
17 Cables, 0.250 Diameter (CAT-6)

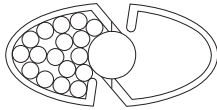

Single-Depth Cable Trough Cover Capacity:
13 Cables, 0.250 Diameter (CAT-6)

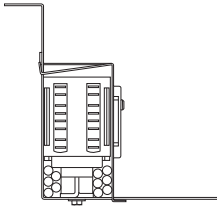

Double-Depth Cable Trough Cover Capacity:
14 Cables, 0.250 Diameter (CAT-6)

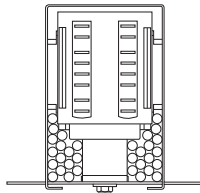

Data Cable Packing in Power Pole:
33 Cables, 0.250 Diameter (CAT-6)

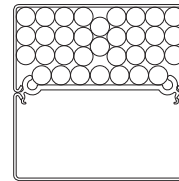

Data Cable Packing in Wire Trough Cover:
14 Cables, 0.250 Diameter (CAT-6)

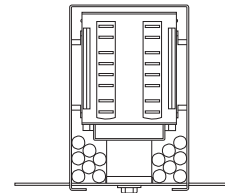











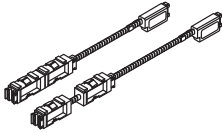





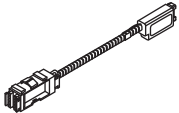

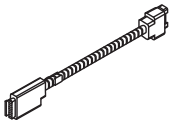

EMPOWER[®] Electrical and Data

GSA SIN 33721

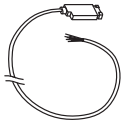
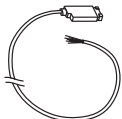

Icon Legend on page 19

WORKSTATIONS

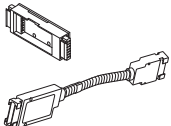
| | DESCRIPTION | MAX. RECEPT. CAP. PER PANEL SIDE | MODEL | | SHIP WEIGHT | CUBE | LIST PRICE |
|---|--|--|--|--|---|------|---------------|
| | | | FOUR-CIRCUIT 3+1 2+2 | THREE-CIRCUIT, SEPARATE NEUTRALS | | | |
|  | Electrical Power Harnesses, Frames — w/duplex capacity | | | | | | |
| | For 48"W | 2 | HH871248  | HH871248A | 3.0  | 0.5 | \$239 |
| | For 60"W | 2 | HH871260  | HH871260A | 3.0  | 0.5 | \$239 |
| | For 72"W | 2 | HH871272 | HH871272A | 5.0  | 0.5 | \$239 |
|  | Electrical Pass-Thru Cables, Frames — w/duplex capacity | | | | | | |
| | For 48"W | 1 | HH871148  | HH871148A | 2.5  | 0.5 | \$151 |
| | For 60"W | 1 | HH871160  | HH871160A | 3.0  | 0.5 | \$151 |
| | For 72"W | 1 | HH871172 | HH871172A | 5.0  | 0.5 | \$151 |
|  | Electrical Pass-Thru Harness without Power Block | | | | | | |
| | For 24"W Frames | 0 | HH871024 | HH871024A | 2.0  | 0.5 | \$132 |
| | For 48"W Frames | 0 | HH871048 | HH871048A | 3.0  | 0.5 | \$137 |
| | For 60"W Frames | 0 | HH871060 | HH871060A | 3.0  | 0.5 | \$137 |
| | For 72"W Frame Runs | 0 | HH871072 | | 4.0  | 0.5 | \$189 |
|  24" Pass-Thru Harness without Power Block is only used when specifying Power In-Feed with Sealtight as a floor in-feed. Harness is not needed for the standard in-feed. | | | | | | | |
|  | Power In-Feed — Sealtight | | | | | | |
| | 144" long conduit, Sealtight Cable — 7/8" diameter | | HMP144 | | 7.0 | 1.2 | \$367 |
| NOTES: For use as ceiling, floor and wall in-feed. If three-circuit, separate neutral in-feed is required, please contact Tailored Solutions. | | | | | | | |
|  | Metal Flexible Conduit | | | | | | |
| | 144" long conduit, Flex Cable — 7/8" dia. | | HMP1912 | | 4.0  | 0.5 | \$263 |
| NOTES: Metal Flexible Conduit. Best option for use with power pole due to bend radius flexibility. | | | | | | | |
|  | Power Jumper | | | | | | |
| | For End of Run | | HMPJUMP | | 2.0 | 0.3 | \$188 |

HOW TO SPECIFY

Select
Model Number

HH871248

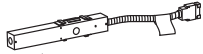

Use when local codes require



Each marked with
Circuit Number

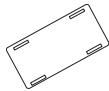

| DESCRIPTION | MODEL | | SHIP WEIGHT | CUBE | LIST PRICE |
|---|--------------------------------|--|-------------|------|--------------|
| | FOUR-CIRCUIT 3 + 1 2 + 2 | THREE-CIRCUIT, SEPARATE NEUTRALS | | | |
| Hardwire Applications Hardwire Power In-feed | HH871400 | HH871400A | 4.0 | 0.3 | \$247 |
| ! Customer to furnish all cabling and wiring from power entry to power source (approved for use by city of New York). | | | | | |
| Hardwire Junction Box (6-pack) | HH871500 | | 4.5 | 0.1 | \$526 |
| ! Hardwire Junction Boxes cannot be installed back-to-back in panel applications. | | | | | |
| ! Contact Tailored Solutions for back-to-back Junction Box standard special number. | | | | | |
| Duplex Receptacles | | | | | |
| Circuit 1 | HH871501 Ⓞ | HH871501A | 1.0 | 0.5 | \$47 |
| Circuit 2 | HH871502 Ⓞ | HH871502A | 1.0 | 0.5 | \$47 |
| Circuit 3 (except 2 + 2 — see below) | HH871503 Ⓞ | HH871503A | 1.0 | 0.5 | \$47 |
| Circuit 4 — isolated, dedicated circuit | HH871504 | | 1.0 | 0.5 | \$47 |
| Circuit 1 (20 amp outlet configuration) | HH871601 | | 1.0 | 0.5 | \$47 |
| Circuit 3 (2 + 2) | HH871506 | | 1.0 | 0.5 | \$47 |
| Specify Paint. Charcoal (S) matches Empower trough. | | | | | |

| DESCRIPTION | MODEL | SHIP WEIGHT | CUBE | LIST PRICE |
|---|------------------|-------------|------|-------------|
| Receptacle Cover Replacements Quantity 25 | HERECPCVR | 1.0 | 0.1 | \$82 |
| ! Specify Color—Available in Black (P), Muslin (T3) and Shadow (SHDW) only. | | | | |

NOTES:

- ! Customer must furnish conduit, wiring and designer type receptacles. (Approved for use by city of Chicago.)
- ! Junction boxes cannot be used back-to-back.

| Duplex Color Recommended to Coordinate with Paint Color | | | |
|---|-------------|----------------|-------------|
| Paint Color | Paint Code | Duplex Color | Duplex Code |
| Black | P | Black | P |
| Brownstone | P7D | Brownstone | EY |
| Charcoal | S | Charcoal | S |
| Designer White | PJW | Designer White | DW |
| Fossil | P28 | Charcoal | S |
| Greige | T5 | Muslin | T3 |
| Light Gray | Q | Loft | LOFT |
| Loft | LOFT | Loft | LOFT |
| Muslin | T3 | Muslin | T3 |
| Putty | L | Black | P |
| Shadow | SHDW | Muslin | T3 |
| Silver | PR6 | Titanium | TI |
| Titanium | P8T | Titanium | TI |
| Champagne Metallic | T4 | Muslin | T3 |
| Platinum Metallic | T1 | Titanium | Ti |

HOW TO SPECIFY

| | |
|--|--|
| <p>Select Model Number</p> <p>HH871400 .</p> | <p>Select Paint Color</p> <p>See page 504</p> <p>P</p> |
|--|--|

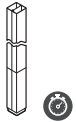

DESCRIPTION

Power Pole
10'5"

MODEL

HMPPP125

SHIP WEIGHT

14

CUBE

0.7

LIST PRICE

P1

\$512

NOTES: Power Pole ships with bracket to attach under stationary Empower® worksurfaces and feed directly into the Wire Management Trough. Power Pole will run to the floor on height adjustable Empower®.



DESCRIPTION

Vertebrae

MODEL

HMPVWM28

SHIP WEIGHT

3.0

CUBE

0.3

LIST PRICE

\$246

NOTES: 30"H x 3 1/8"W x 1 1/2"D. Ships unassembled. For additional information see the Workplace Tools section in the 2021 Shared Spaces Pricer. For use with stationary Empower®.

! Clear finish. Specify "X" for finish option.

SPECIFYING EXAMPLE: HMPVWM28.X

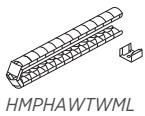

HMPHAWTWML



HMPHATFWML

Wire Managers for Height Adjustable

Workstation to Trough
Trough to Floor

HMPHAWTWML ☉

3.0

0.1

\$295

HMPHATFWML

2.0

0.3

\$269

! Wire Manager Workstation to Trough only available in black.

! HMPHATFWML Trough to Floor cable manager is 3" x 1 1/2".

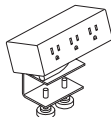

Model HPWRMOD3WC shown

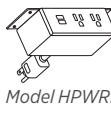

Model HPWRMOD2UWM shown

Power Modules

3 Receptacles with Worksurface Clamp
3 Receptacles with Under-Worksurface Mounting Bracket
2 Receptacles 2 USB with Worksurface Clamp
2 Receptacles 2 USB with Under-Worksurface Mounting Bracket

HPWRMOD3WC ☉

2.3 **S**

0.2

\$342

HPWRMOD3UWM

2.3

0.2

\$342

HPWRMOD2WC ☉

2.3

0.2

\$546

HPWRMOD2UWM

2.3

0.2

\$546

- 6' power cord with standard three-prong plug.
- Under-worksurface mounting bracket models work with any top that has a 5" x 5" square clearance.
- Worksurface clamp models work on any top with a 4" overhang.
- UL Listed.

NOTES: For additional information see the Workplace Tools section in the 2021 Shared Spaces Pricer.

! Color finish coordinates with HON's Charcoal or White. Specify STRM for Storm or SNW for Snow when ordering.
Example: HPWRMOD3WC.STRM.

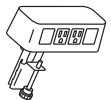

Power & Data Center

2 Receptacles 2 Data Accessory
• Standard with two receptacles and openings for two data ports.
• 6' power cord with standard three-prong plug.
• Fits on any worksurface with a 4" overhang.
• UL Listed.

HCOMDOME2

2.5 **S**

0.2

\$327

NOTES: For additional information see the Workplace Tools section in the 2021 Shared Spaces Pricer.

! Color finish coordinates with HON's Loft. Specify LOFT when ordering. Example: HCOMDOME2.LOFT

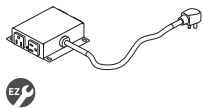

EZ

Under Worksurface Power Module — 4 Outlets, 10' Cord

• Includes 10' cord with three-prong plug.
• Fits in cable management troughs. See page 613.
• 4 outlets on side create easy access.

HPWRMOD2

1.5 **S**

0.2

\$441

NOTES: Power Modules will also work with standing-height applications for 10500 Series™ and Voi® desks. Mounting Clearance: 5.025" x 4.875" x 1.375". For additional information see the Workplace Tools section in the 2021 Shared Spaces Pricer.

! Black finish only, no specification needed.

HOW TO SPECIFY

Select Model Number

Select Finish Color

STRM Storm
SNW Snow
LOFT Loft

Specify Loft finish for HCOMDOME2 only

H M P P P 1 2 5 .

S T R M



Icon Legend on page 19

EMPOWER[®] Voi[®] Laminate Low Credenzas

WORKSTATIONS

| | DESCRIPTION | MODEL | SHIP WEIGHT | CUBE | L1 LIST | L2 UPCHARGES | | | | |
|--|--|--------------------|-------------|------|---------------|--------------|--------------|--------------|--------------|--------------|
| | | | | | | CHASSIS | FRONTS | | | |
| | Low Credenza, 2 File/2 Box 72"W x 20"D x 21½"H 60"W x 20"D x 21½"H NOTES: Unit is locking. | HLSL2072LD4 | 230 | 21.9 | \$1806 | \$40 | \$40 | | | |
| | | HLSL2060LD4 | 190 | 18.9 | \$1647 | \$35 | \$40 | | | |
| | Low Credenza, 2 File Drawers, Open Top 72"W x 20"D x 21½"H 60"W x 20"D x 21½"H NOTES: Unit is non-locking. | HLSL2072LD2 | 200 | 21.9 | \$1688 | \$40 | \$30 | | | |
| | | HLSL2060LD2 | 160 | 18.9 | \$1543 | \$35 | \$30 | | | |
| | Low Credenza, Left Hand Drawers 72"W x 20"D x 21½"H 60"W x 20"D x 21½"H NOTES: Unit is locking. | HLSL2072LL2 | 200 | 21.9 | \$1672 | \$40 | \$20 | | | |
| | | HLSL2060LL2 | 160 | 18.9 | \$1412 | \$35 | \$20 | | | |
| | Low Credenza, Right Hand Drawers 72"W x 20"D x 21½"H 60"W x 20"D x 21½"H NOTES: Unit is locking. | HLSL2072LR2 | 200 | 21.9 | \$1672 | \$40 | \$20 | | | |
| | | HLSL2060LR2 | 160 | 18.9 | \$1412 | \$35 | \$20 | | | |
| | Low Credenza, Open 72"W x 20"D x 21½"H 60"W x 20"D x 21½"H SPECIFYING EXAMPLE: HLSL2072LD0.Z (model.chassis only) | HLSL2072LD0 | 170 | 21.9 | \$1421 | \$40 | N/A | | | |
| | | HLSL2060LD0 | 130 | 18.9 | \$1180 | \$35 | N/A | | | |
| | Low Credenza, 4 Storage Doors 72"W x 20"D x 21½"H 60"W x 20"D x 21½"H NOTES: Unit is locking. | HLSL2072S4 | 190 | 21.9 | \$1792 | \$40 | \$40 | | | |
| | | HLSL2060S4 | 160 | 18.9 | \$1540 | \$35 | \$40 | | | |
| | Credenza Cushion 20"W x 36"D x 1"H for 72" Credenzas 20"W x 30"D x 1"H for 60" Credenzas NOTES: See pages 502-503 for available fabrics. SPECIFYING EXAMPLE: HLSL2036CH2.APN23 | HLSL2036CH2 | 11 | 2.2 | \$451 | \$489 | \$527 | \$566 | \$615 | \$665 |
| | | HLSL2030CH2 | 9 | 1.9 | \$418 | \$454 | \$490 | \$526 | \$572 | \$619 |

NOTES:

- Chassis and drawer fronts woodgrains and solid laminates are specified separately (see SIF options below).
- File drawers accept hanging folders in letter size.
- Multiple handle locations possible per customer preference.
- Seat cushions are available for low credenzas and mobile pedestals (specify separately).
- Storage accessory model HLSLDRWORG works with box doors.
- Adjustable hex leveling glides allow floor-standing furniture to be easily leveled without lifting the unit; glides have 1/4" adjustable range.
- Ships with one handle per drawer on all units.
- ! Locking units equipped with HON "One Key" interchangeable core removable locks. Keyed alike core must be ordered separately.

HOW TO SPECIFY

| | | | |
|--|--|---|--|
| <p>Select Model Number</p> <p>HLSL2072LD4</p> | <p>Select Chassis Laminate</p> <p>See page 183</p> <p>N</p> | <p>Select Drawer Front Laminate</p> <p>See page 183</p> <p>N</p> | <p>Select Pull Color</p> <p>See page 183</p> <p>Not specified for Open Credenza models HLSL2072LD0, HLSL2060LD0</p> <p>T4</p> |
|--|--|---|--|

EMPOWER® Voi® Laminate Low Credenzas

GSA SIN 33721



Icon Legend on page 19

WORKSTATIONS

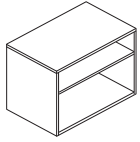

DESCRIPTION

Low Credenza — Open
30"W x 20"D x 21½"H
36"W x 20"D x 21½"H

MODEL

HLSL2030LDO
HLSL2036LDO

SHIP WEIGHT

65
85

CUBE

9.8
12.0

L1 LIST

\$977
\$1006

L2 UPCHARGES

CHASSIS **FRONTS**
\$25 N/A
\$30 N/A

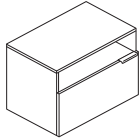

Low Credenza — Open Top, File Drawer
30"W x 20"D x 21½"H
36"W x 20"D x 21½"H

HLSL2030LD1
HLSL2036LD1

75
95

9.8
12.0

\$1085
\$1118

\$25 **\$15**
\$30 **\$15**

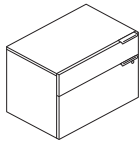

Low Credenza — 1 File Drawer, 1 Box Drawer
30"W x 20"D x 21½"H
36"W x 20"D x 21½"H

HLSL2030LD2
HLSL2036LD2

80
100

9.8
12.0

\$1206
\$1241

\$25 **\$20**
\$30 **\$20**

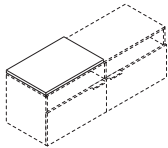

DESCRIPTION

Credenza Cushion
20"W x 36"D x 1"H for 72" Credenzas
20"W x 30"D x 1"H for 60" Credenzas

MODEL

HLSL2036CH2
HLSL2030CH2

SHIP WEIGHT

11
9

CUBE

2.2
1.9

1 2 3 4 5 6

\$451 **\$489** **\$527** **\$566** **\$615** **\$665**
\$418 **\$454** **\$490** **\$526** **\$572** **\$619**

NOTES: See pages 502-503 for available fabrics.

! For model HLSL2030CH2 must order two cushions to cover entire 60" Credenza surface.

SPECIFYING EXAMPLE: HLSL2036CH2.APN23

NOTES:

- File drawers accept hanging folders in letter size.
- Multiple handle locations possible per customer preference.
- Seat cushions are available for low credenzas and mobile pedestals (specify separately).
- Storage accessory model HLSLDRWORG works with box doors.
- Utilize in small footprint applications.
- Adjustable hex leveling glides allow floor-standing furniture to be easily leveled without lifting the unit; glides have 1¼" adjustable range.
- Ships with one handle per drawer on all units.

! Locking units equipped with HON "One Key" interchangeable core removable locks. Keyed alike core must be ordered separately.

HOW TO SPECIFY

| | | | |
|--|--|--|---|
| <p>Select Model Number</p> <p>See page 183</p> <p>H L S L 2 0 3 0 L D O .</p> | <p>Select Chassis Laminate</p> <p>See page 183</p> <p>N .</p> | <p>Select Drawer Front Laminate</p> <p>See page 183</p> <p>Not specified for Open Credenza models HLSL2030LDO, HLSL2036LDO</p> <p>N .</p> | <p>Select Pull Color</p> <p>See page 183</p> <p>Not specified for Open Credenza models HLSL2030LDO, HLSL2036LDO</p> <p>T 4</p> |
|--|--|--|---|



EMPOWER[®] Voi[®] Laminate Mobile Storage

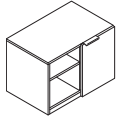

DESCRIPTION

Mobile Credenza
30"W x 20"D x 21½"H
NOTES: Unit is non-locking.

| MODEL | SHIP WEIGHT | CUBE | L1 LIST | L2 UPCHARGES | |
|-------------|-------------|------|---------|--------------|--------|
| | | | | CHASSIS | FRONTS |
| HLSL2030MCO | 80 | 9.8 | \$1566 | \$25 | \$10 |

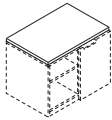

DESCRIPTION

Credenza Cushion
20"W x 30"D x 1"H for 60" Credenzas
NOTES: See pages 502-503 for available fabrics.
SPECIFYING EXAMPLE: HLSL2030CH2.APN23

| MODEL | SHIP WEIGHT | CUBE | 1 | 2 | 3 | 4 | 5 | 6 |
|-------------|-------------|------|-------|-------|-------|-------|-------|-------|
| HLSL2030CH2 | 9 | 1.9 | \$418 | \$454 | \$490 | \$526 | \$572 | \$619 |

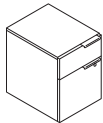

DESCRIPTION

Mobile Pedestal
15¾"W x 20⅞"D x 21⅞"H
NOTES: Unit is locking.

| MODEL | SHIP WEIGHT | CUBE | L1 LIST | L2 UPCHARGES | |
|-------------|-------------|------|---------|--------------|--------|
| | | | | CHASSIS | FRONTS |
| HLSL2016MP2 | 65 | 5.7 | \$893 | \$20 | \$10 |

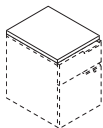

DESCRIPTION

Mobile Pedestal Cushion
15⅞"W x 20"D x 1"H for Pedestals
NOTES: See pages 502-503 for available fabrics.
SPECIFYING EXAMPLE: HLSL2016PH2.APN23

| MODEL | SHIP WEIGHT | CUBE | 1 | 2 | 3 | 4 | 5 | 6 |
|-------------|-------------|------|-------|-------|-------|-------|-------|-------|
| HLSL2016PH2 | 6 | 1.1 | \$347 | \$371 | \$395 | \$419 | \$450 | \$481 |

NOTES:

- Chassis and drawer fronts woodgrains and solid laminates are specified separately (see SIF options below).
- File drawers accept hanging folders in letter or legal size.
- Multiple handle locations possible per customer preference.
- Seat cushions are available for low credenzas, floor credenzas, and mobile pedestals (specify separately). See pages 547-549 for Pedestal and Credenza cushion models.
- Storage accessory model HSLDRWORG works with box doors.
- Standard box drawers operate on ball-bearing suspension with 70% extension. File drawers operate on ball-bearing suspension with 70% extension.
- Ships with one handle per drawer on all units.

! Locking units equipped with HON "One Key" interchangeable core removable locks. Keyed alike core must be ordered separately.

HOW TO SPECIFY

| | | | |
|--|--|---|--|
| <p>Select Model Number</p> <p>H L S L 2 0 3 0 M C O . N .</p> | <p>Select Chassis Laminate</p> <p>See page 504</p> <p>N .</p> | <p>Select Drawer Front Laminate</p> <p>See page 504</p> <p>N .</p> | <p>Select Pull Color</p> <p>P Black T4 Champagne T1 Platinum PJW Designer White PR6 Silver PBX Solar Black</p> <p>T 4</p> |
|--|--|---|--|

EMPOWER® Voi® Laminate Storage Towers

GSA SIN 33721



Icon Legend on page 19

WORKSTATIONS

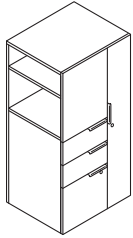

| DESCRIPTION | MODEL | SHIP WEIGHT | CUBE | L1 LIST | L2 UPCHARGES | |
|---|------------------|-------------|------|---------------|--------------|-------------|
| | | | | | CHASSIS | FRONTS |
| 24"W x 20"D Storage Tower — Right Hand Drawers, Left Hand Door | | | | | | |
| 24"W x 20"D x 50"H, Left | HLSLW045L | 167 | 17.4 | \$2159 | \$50 | \$35 |
| 24"W x 20"D x 65"H, Left | HLSLW046L | 200 | 22.5 | \$2449 | \$55 | \$35 |
| 24"W x 20"D Storage Tower — Left Hand Drawers, Right Hand Door | | | | | | |
| 24"W x 20"D x 50"H, Right | HLSLW045R | 167 | 17.4 | \$2159 | \$50 | \$35 |
| 24"W x 20"D x 65"H, Right | HLSLW046R | 200 | 22.5 | \$2449 | \$55 | \$35 |

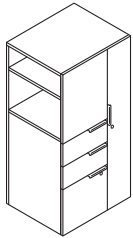

| | | | | | | |
|---|------------------|-----|------|---------------|-------------|-------------|
| 24"W x 24"D Storage Tower — Right Hand Drawers, Left Hand Door | | | | | | |
| 24"W x 24"D x 50"H, Left | HLSLW445L | 200 | 20.7 | \$2339 | \$55 | \$35 |
| 24"W x 24"D x 65"H, Left | HLSLW446L | 240 | 27.8 | \$2578 | \$60 | \$35 |
| 24"W x 24"D Storage Tower — Left Hand Drawers, Right Hand Door | | | | | | |
| 24"W x 24"D x 50"H, Right | HLSLW445R | 200 | 20.7 | \$2339 | \$55 | \$35 |
| 24"W x 24"D x 65"H, Right | HLSLW446R | 240 | 27.8 | \$2578 | \$60 | \$35 |

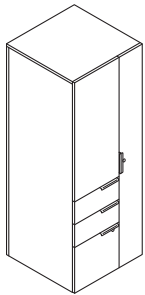

| | | | | | | |
|---|-------------------|-----|------|---------------|-------------|-------------|
| 24"W x 24"D Personal Storage Tower | | | | | | |
| 24"W x 24"D x 65"H, Left | HLSLW446LP | 250 | 27.8 | \$2920 | \$60 | \$35 |
| 24"W x 24"D x 65"H, Right | HLSLW446RP | 250 | 27.8 | \$2920 | \$60 | \$35 |

NOTES:

- Chassis and drawer fronts woodgrains and solid laminates are specified separately (see SIF options below).
- File drawers accept hanging folders in letter or legal size.
- Wardrobe, middle box drawer and file drawer are locking.
- Standard box drawers operate on ball-bearing suspension with full extension. File, lateral, and wide box drawers operate on ball-bearing suspension with full extension.
- Ships with one handle per drawer on all units.
- Adjustable hex leveling glides allow floor-standing furniture to be easily leveled without lifting the unit; glides have 1/4" adjustable range.
- Wardrobe/storage cabinet includes coat rod.
- Wardrobes contain easy access side storage shelves.

ⓘ Locking units equipped with HON "One Key" interchangeable core removable locks. Keyed alike core must be ordered separately.

HOW TO SPECIFY

| | | | |
|--|--|---|---|
| <p>Select Model Number</p> <p>HLSLW045L</p> | <p>Select Chassis Laminate</p> <p>See page 183</p> <p>N</p> | <p>Select Drawer Front Laminate</p> <p>See page 183</p> <p>N</p> | <p>Select Pull Color</p> <p>See page 183</p> <p>T4</p> |
|--|--|---|---|



Icon Legend on page 19

EMPOWER[®] Voi[®] Laminate Storage Towers

WORKSTATIONS

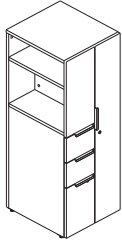

DESCRIPTION

18"W x 20"D Storage Towers — Right Hand Drawers, Left Hand Door

| | MODEL | SHIP WEIGHT | CUBE | L1 LIST | L2 UPCHARGES CHASSIS | FRONTS |
|--------------------------|------------------|-------------|------|---------------|----------------------|-------------|
| 18"W x 20"D x 50"H, Left | HLSLW085L | 139 | 13.4 | \$1943 | \$45 | \$35 |
| 18"W x 20"D x 65"H, Left | HLSLW086L | 167 | 17.3 | \$2208 | \$50 | \$35 |

18"W x 20"D Storage Towers — Left Hand Drawers, Right Hand Door

| | | | | | | |
|---------------------------|------------------|-----|------|---------------|-------------|-------------|
| 18"W x 20"D x 50"H, Right | HLSLW085R | 139 | 13.4 | \$1943 | \$45 | \$35 |
| 18"W x 20"D x 65"H, Right | HLSLW086R | 167 | 17.3 | \$2208 | \$50 | \$35 |

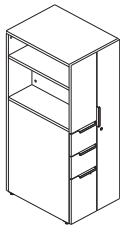

18"W x 24"D Storage Towers — Right Hand Drawers, Left Hand Door

| | | | | | | |
|--------------------------|------------------|-----|------|---------------|-------------|-------------|
| 18"W x 24"D x 50"H, Left | HLSLW485L | 167 | 15.8 | \$2212 | \$50 | \$35 |
| 18"W x 24"D x 65"H, Left | HLSLW486L | 200 | 21.5 | \$2452 | \$55 | \$35 |

18"W x 24"D Storage Towers — Left Hand Drawers, Right Hand Door

| | | | | | | |
|---------------------------|------------------|-----|------|---------------|-------------|-------------|
| 18"W x 24"D x 50"H, Right | HLSLW485R | 167 | 15.8 | \$2212 | \$50 | \$35 |
| 18"W x 24"D x 65"H, Right | HLSLW486R | 200 | 21.5 | \$2452 | \$55 | \$35 |

NOTES:

- Ships with one handle per drawer on all units.
- Chassis and drawer fronts woodgrains and solid laminates are specified separately (see SIF options below).
- File drawers accept hanging folders in letter or legal size.
- Standard box drawers operate on ball-bearing suspension with full extension. File and box drawers operate on ball-bearing suspension with full extension.
- Adjustable hex leveling glides allow floor-standing furniture to be easily leveled without lifting the unit; glides have 1/4" adjustable range.
- Wardrobe/storage cabinet includes coat rod.
- Wardrobes contain easy access side storage shelves.
- Wardrobe, middle box drawer and file drawer are locking.

! Locking units equipped with HON "One Key" interchangeable core removable locks. Keyed alike core must be ordered separately.

HOW TO SPECIFY

| | | | |
|---|--|--|---|
| <p>Select Model Number</p> <p>HL SLW085L</p> | <p>Select Chassis Laminate</p> <p>See page 183</p> <p>N</p> | <p>Select Door/Drawer Front Laminate</p> <p>See page 183</p> <p>N</p> | <p>Select Pull Color</p> <p>See page 183</p> <p>T4</p> |
|---|--|--|---|

EMPOWER[®] Contain[®] Metal Credenzas

GSA SIN 33721



Icon Legend on page 19

WORKSTATIONS

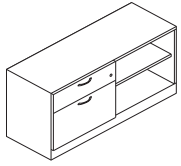

DESCRIPTION

Low Credenza, Box/Lateral Left, Open Shelf Right
72"W x 18"D x 22"H
60"W x 18"D x 22"H
48"W x 18"D x 22"H

MODEL

HSCP227218RBFOM
HSCP226018RBFOM
HSCP224818RBFOM

SHIP WEIGHT

150
130
111

CUBE

20.7
17.3
14.0

LIST PRICE BY PAINT GRADE

P1 P2 P3

\$2154 \$2221 \$2289
\$1943 \$2010 \$2078
\$1792 \$1859 \$1927

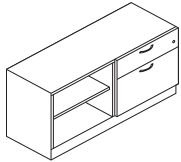

Low Credenza, Box/Lateral Right, Open Shelf Left
72"W x 18"D x 22"H
60"W x 18"D x 22"H
48"W x 18"D x 22"H

HSCP227218LBFOM
HSCP226018LBFOM
HSCP224818LBFOM

150
130
111

20.7
17.3
14.0

\$2154 \$2221 \$2289
\$1943 \$2010 \$2078
\$1792 \$1859 \$1927

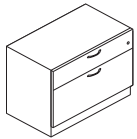

Low Credenza, Box/Lateral
36"W x 18"D x 22"H
30"W x 18"D x 22"H

HSCP223618BFM
HSCP223018BFM

87
76

10.6
9.0

\$1318 \$1351 \$1386
\$1263 \$1296 \$1331

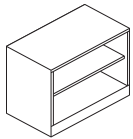

Open Shelf
36"W x 18"D x 22"H
30"W x 18"D x 22"H

HSCP223618O
HSCP223018O

66
60

10.6
9.0

\$939 \$972 \$1007
\$865 \$898 \$933

NOTES:

- Metal chassis and drawer fronts.
- Lateral and wide box drawers operate on ball-bearing suspension with full extension.
- Steel ball-bearing drawer suspensions.
- Ships complete with standard kickplate.
- Field installable counterweight sold separately.
- File drawers accept hanging folders in letter or legal size.
- Steel frame provides durability.
- Use with laminate tops and credenza seat cushions. Order separately — see pages 675-676.

⚠ Locking units equipped with HON "One Key" interchangeable core removable locks. Keyed alike core model HF23S, in Satin, must be ordered separately. See page 675.

HOW TO SPECIFY

| | | | |
|--|--|--|---|
| <p>Select Model Number</p> <p>H S C P 2 2 3 6 1 8 O .</p> | <p>Select Base</p> <p>BK Flush Plinth BX Recessed Plinth</p> <p>B K .</p> | <p>Select Case Paint</p> <p>See page 666</p> <p>P J W .</p> | <p>Select Shelf Paint</p> <p>See page 666</p> <p>P J W .</p> |
|--|--|--|---|

| | | | | | | |
|--|--|---|--|--|--|---|
| <p>Select Model Number</p> <p>H S C P 2 2 7 2 1 8 R B F O M .</p> | <p>Select Base</p> <p>BK Flush Plinth BX Recessed Plinth</p> <p>B K .</p> | <p>Select Pull</p> <p>A Arch PRO Silver R Radius N Integral S Square PR6 Silver</p> <p>A P R O .</p> | <p>Select Case Paint</p> <p>See page 666</p> <p>P J W .</p> | <p>Select Front Paint</p> <p>NA Matches Case</p> <p>N A .</p> | <p>Select Shelf Paint</p> <p>See page 666 Not specified for models HSCP223018BFM and HSCP223618BFM</p> <p>P J W .</p> | <p>Select Lock</p> <p>L Standard Lock X Omit Lock (- \$20) Not specified for models HSCP223618O and HSCP223018O</p> <p>L .</p> |
|--|--|---|--|--|--|---|



Icon Legend on page 19

EMPOWER® Contain® Footed Metal Credenzas

WORKSTATIONS

| | DESCRIPTION | MODEL | SHIP WEIGHT | CUBE | LIST PRICE BY PAINT GRADE | | |
|--|--|------------------------|-------------|------|---------------------------|---------------|---------------|
| | | | | | P1 | P2 | P3 |
| | Footed Low Credenza, Box/Lateral Left, Open Shelf Right | | | | | | |
| | 72"W x 18"D x 22"H | HSCF227218RBFOM | 150 | 17.7 | \$2327 | \$2394 | \$2462 |
| | 60"W x 18"D x 22"H | HSCF226018RBFOM | 130 | 14.9 | \$2118 | \$2185 | \$2253 |
| | 48"W x 18"D x 22"H | HSCF224818RBFOM | 111 | 12.0 | \$1932 | \$1999 | \$2067 |
| | Footed Low Credenza, Box/Lateral Right, Open Shelf Left | | | | | | |
| | 72"W x 18"D x 22"H | HSCF227218LBFOM | 150 | 17.7 | \$2327 | \$2394 | \$2462 |
| | 60"W x 18"D x 22"H | HSCF226018LBFOM | 130 | 14.9 | \$2118 | \$2185 | \$2253 |
| | 48"W x 18"D x 22"H | HSCF224818LBFOM | 111 | 12.0 | \$1932 | \$1999 | \$2067 |
| | Footed Low Credenza, Box/Lateral | | | | | | |
| | 36"W x 18"D x 22"H | HSCF223618BFM | 87 | 9.1 | \$1457 | \$1490 | \$1525 |
| | 30"W x 18"D x 22"H | HSCF223018BFM | 76 | 7.7 | \$1401 | \$1434 | \$1469 |
| | Footed Open Shelf | | | | | | |
| | 36"W x 18"D x 22"H | HSCF223618O | 66 | 9.1 | \$1079 | \$1112 | \$1147 |
| | 30"W x 18"D x 22"H | HSCF223018O | 60 | 7.7 | \$1004 | \$1037 | \$1072 |

NOTES:

- Lateral and wide box drawers operate on ball-bearing suspension with full extension.
 - Steel ball-bearing drawer suspensions.
 - Ships complete with standard footed base.
 - Field installable counterweight sold separately.
 - File drawers accept hanging folders in letter or legal size.
 - Steel frame provides durability.
 - Feet are shipped with the credenza unit and are easily assembled.
 - Use with laminate tops and credenza seat cushions. Order separately — see pages 675-676.
- ⓘ Locking units equipped with HON "One Key" interchangeable core removable locks. Keyed alike core model HF23S, in Satin, must be ordered separately. See page 675.

HOW TO SPECIFY

| | | | |
|--|---|--|---|
| <p>Select Model Number</p> <p>H S C F 2 2 3 6 1 8 0 .</p> | <p>Select Foot</p> <p>SF Contain Foot T1 Platinum Metallic PR6 Silver</p> <p>S F T 1 .</p> | <p>Select Case Paint</p> <p>See page 666</p> <p>P J W .</p> | <p>Select Shelf Paint</p> <p>See page 666</p> <p>P J W .</p> |
|--|---|--|---|

| | | | | | | |
|--|---|---|--|--|--|---|
| <p>Select Model Number</p> <p>H S C F 2 2 7 2 1 8 R B F O M .</p> | <p>Select Foot</p> <p>SF Contain Foot T1 Platinum Metallic PR6 Silver</p> <p>S F T 1 .</p> | <p>Select Pull</p> <p>A Arch PRO Silver R Radius N Integral S Square PR6 Silver</p> <p>A P R O .</p> | <p>Select Case Paint</p> <p>See page 666</p> <p>P J W .</p> | <p>Select Front Paint</p> <p>NA Matches Case</p> <p>N A .</p> | <p>Select Shelf Paint</p> <p>See page 666 Not specified for models HSCF223618BFM and HSCF223018BFM</p> <p>P J W .</p> | <p>Select Lock</p> <p>L Standard Lock X Omit Lock (- \$20) Not specified for models HSCF223618O and HSCF223018O</p> <p>L .</p> |
|--|---|---|--|--|--|---|



Icon Legend on page 19

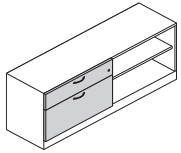

DESCRIPTION

Metal Low Credenza, Laminate Front, Box/Lateral Left, Open Shelf Right
 72"W x 18"D x 22"H
 60"W x 18"D x 22"H
 48"W x 18"D x 22"H

MODEL

HSCP227218RBFOL
HSCP226018RBFOL
HSCP224818RBFOL

SHIP WEIGHT

CUBE

LIST PRICE BY PAINT GRADE

P1 P2 P3

| | | | | |
|-----|------|--------|--------|--------|
| 152 | 20.7 | \$2389 | \$2456 | \$2524 |
| 132 | 17.3 | \$2179 | \$2246 | \$2314 |
| 113 | 14.0 | \$2027 | \$2094 | \$2162 |

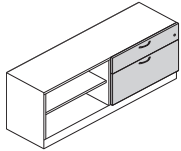

Metal Low Credenza, Laminate Front, Box/Lateral Right, Open Shelf Left
 72"W x 18"D x 22"H
 60"W x 18"D x 22"H
 48"W x 18"D x 22"H

HSCP227218LBFOL
HSCP226018LBFOL
HSCP224818LBFOL

| | | | | |
|-----|------|--------|--------|--------|
| 152 | 20.7 | \$2389 | \$2456 | \$2524 |
| 132 | 17.3 | \$2179 | \$2246 | \$2314 |
| 113 | 14.0 | \$2027 | \$2094 | \$2162 |

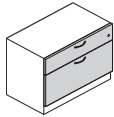

Metal Low Credenza, Laminate Front Box/Lateral
 36"W x 18"D x 22"H
 30"W x 18"D x 22"H

HSCP223618BFL
HSCP223018BFL

| | | | | |
|----|------|--------|--------|--------|
| 89 | 10.6 | \$1553 | \$1586 | \$1621 |
| 76 | 9.0 | \$1497 | \$1530 | \$1565 |

NOTES:

- Lateral and wide box drawers operate on ball-bearing suspension with full extension.
- Steel ball-bearing drawer suspensions.
- Ships complete with standard kickplate.
- Field installable counterweight sold separately.
- File drawers accept hanging folders in letter or legal size.
- Steel frame provides durability.
- Use with laminate tops and credenza seat cushions. Order separately — see pages 675-676.

ⓘ Locking units equipped with HON "One Key" interchangeable core removable locks. Keyed alike core model HF23S, in Satin, must be ordered separately. See page 675.

HOW TO SPECIFY

| Select Model Number | Select Base | Select Pull | Select Case Paint | Select Laminate | Select Shelf Paint | Select Lock |
|---------------------------------|---------------------------|--|-------------------|-----------------|--|---|
| | BX Recessed Plinth | A Arch PRO Silver S Square PR6 Silver | See page 666 | See page 666 | See page 666 Not specified for models HSCP223618BFL and HSCP223018BFL | L Standard Lock X Omit Lock (- \$20) |
| H S C P 2 2 7 2 1 8 R B F O L . | B X . | A P R O . | P J W . | L S A 1 . | P J W . | L |



Icon Legend on page 19

Contain® Footed Metal Credenzas with Laminate Fronts

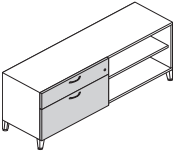
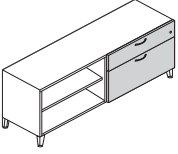
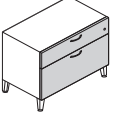
| | DESCRIPTION | MODEL | SHIP WEIGHT | CUBE | LIST PRICE BY PAINT GRADE | | |
|---|--|------------------------|-------------|------|---------------------------|---------------|---------------|
| | | | | | P1 | P2 | P3 |
|  | Footed Low Credenza, Laminate Front, Box/Lateral Left, Open Shelf Right | | | | | | |
| | 72"W x 18"D x 22"H | HSCF227218RBFOL | 152 | 17.7 | \$2564 | \$2631 | \$2699 |
| | 60"W x 18"D x 22"H | HSCF226018RBFOL | 132 | 14.9 | \$2352 | \$2419 | \$2487 |
| | 48"W x 18"D x 22"H | HSCF224818RBFOL | 113 | 12.0 | \$2167 | \$2234 | \$2302 |
|  | Footed Low Credenza, Laminate Front, Box/Lateral Right, Open Shelf Left | | | | | | |
| | 72"W x 18"D x 22"H | HSCF227218LBFOL | 152 | 17.7 | \$2564 | \$2631 | \$2699 |
| | 60"W x 18"D x 22"H | HSCF226018LBFOL | 132 | 14.9 | \$2352 | \$2419 | \$2487 |
| | 48"W x 18"D x 22"H | HSCF224818LBFOL | 113 | 12.0 | \$2167 | \$2234 | \$2302 |
|  | Footed Low Credenza, Laminate Front Box/Lateral | | | | | | |
| | 36"W x 18"D x 22"H | HSCF223618BFL | 89 | 9.1 | \$1692 | \$1725 | \$1760 |
| | 30"W x 18"D x 22"H | HSCF223018BFL | 78 | 7.7 | \$1638 | \$1671 | \$1706 |

NOTES:

- Lateral and wide box drawers operate on ball-bearing suspension with full extension.
- Steel ball-bearing drawer suspensions.
- Ships complete with standard footed base.
- Field installable counterweight sold separately.
- File drawers accept hanging folders in letter or legal size.
- Steel frame provides durability.
- Feet are shipped with the credenza unit and are easily assembled.
- Use with laminate tops and credenza seat cushions. Order separately — see pages 675-676.

! Locking units equipped with HON "One Key" interchangeable core removable locks. Keyed alike core model HF23S, in Satin, must be ordered separately. See page 675.

HOW TO SPECIFY

| | | | | | | |
|---|--|--|---|---|--|--|
| Select Model Number H S C F 2 2 7 2 1 8 R B F O L | Select Foot SF Contain Foot T1 Platinum Metallic PR6 Silver | Select Pull A Arch PRO Silver S Square PR6 Silver | Select Case Paint See page 666 P J W | Select Laminate See page 666 L S A 1 | Select Shelf Paint See page 666 Not specified for models HSCF223618BFL and HSCF223018BFL P J W | Select Lock L Standard Lock X Omit Lock (- \$20) L |
|---|--|--|---|---|--|--|

EMPOWER[®] Contain[®] Metal Credenzas Accessories

GSA SIN 33721



Icon Legend on page 19

WORKSTATIONS

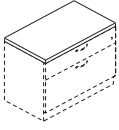

| DESCRIPTION | MODEL | SHIP WEIGHT CUBE | | | | | | | | | | | | | |
|---|-------------------|------------------|-----|-------|-------|-------|-------|-------|-------|-------|-------|-------|-------|-------|-------|
| | | 1 | 2 | 3 | 4 | 5 | 6 | 7 | 8 | 9 | 10 | 11 | 12 | | |
| Credenza Cushion 36"W x 18"D for 36", 60", and 72" Credenzas | HSCAUC1836 | 16.3 | 1.6 | \$313 | \$351 | \$389 | \$428 | \$477 | \$527 | \$577 | \$626 | \$676 | \$725 | \$775 | \$825 |
| 30"W x 18"D for 30", 48", and 60" Credenzas | HSCAUC1830 | 16.3 | 1.6 | \$292 | \$330 | \$368 | \$407 | \$456 | \$506 | \$556 | \$605 | \$655 | \$704 | \$754 | \$804 |
| 24"W x 18"D for 48" Credenzas | HSCAUC1824 | 16.3 | 1.9 | \$273 | \$311 | \$349 | \$388 | \$437 | \$487 | \$537 | \$586 | \$636 | \$685 | \$735 | \$785 |

NOTES: See pages 22-24 for available fabrics.
SPECIFYING EXAMPLE: HSCAUC1836.APN23

NOTES:

- For matching Pedestal Seats, see page 701.
- Credenza Cushions are available in 24", 30" and 36" size options.
- Choose from multiple upholstery options, see pages 22-24.

HOW TO SPECIFY

| | |
|----------------------------|----------------------|
| Select Model Number | Select Fabric |
| | See pages 22-24 |
| H S C A U C 1 8 3 6 . | A B 1 0 |

| | DESCRIPTION | MODEL | SHIP WEIGHT | CUBE | LIST PRICE |
|---|--------------------------------------|-----------------|-------------|------|--------------|
| | | | | | P1 |
| | Metal Box Divider 10 pack | HSCABD10 | 7 | 0.7 | \$189 |
| | 2 pack | HSCABD02 | 2 | 0.7 | \$48 |
| ! Metal dividers available in Black only. No need to specify. | | | | | |
| | Metal File Divider 10 pack | HSCAFD10 | 12 | 0.7 | \$224 |
| | 2 pack | HSCAFD02 | 3 | 0.7 | \$60 |
| ! Metal dividers available in Black only. No need to specify. | | | | | |



Icon Legend on page 19

EMPOWER® Contain® Metal Personal Towers

| | DESCRIPTION | MODEL | SHIP WEIGHT | CUBE | LIST PRICE BY PAINT GRADE | | |
|--|--|------------------------|-------------|------|---------------------------|---------------|---------------|
| | | | | | P1 | P2 | P3 |
| | Personal Tower with Metal Fronts, Door/Box/Box/File | | | | | | |
| | 65"H x 24"W x 24"D, Wardrobe Left | HSTP652424LBBFM | 178 | 27.2 | \$2266 | \$2343 | \$2411 |
| | 65"H x 24"W x 24"D, Wardrobe Right | HSTP652424RBBFM | 178 | 27.2 | \$2266 | \$2343 | \$2411 |
| | 50"H x 24"W x 24"D, Wardrobe Left | HSTP502424LBBFM | 146 | 21.2 | \$2120 | \$2197 | \$2265 |
| | 50"H x 24"W x 24"D, Wardrobe Right | HSTP502424RBBFM | 146 | 21.2 | \$2120 | \$2197 | \$2265 |
| | 42"H x 24"W x 24"D, Wardrobe Left | HSTP422424LBBFM | 132 | 16.8 | \$1822 | \$1872 | \$1947 |
| | 42"H x 24"W x 24"D, Wardrobe Right | HSTP422424RBBFM | 132 | 16.8 | \$1822 | \$1872 | \$1947 |
| | Personal Tower with Metal Fronts, Door/File/File | | | | | | |
| | 65"H x 24"W x 24"D, Wardrobe Left | HSTP652424LFFM | 178 | 27.2 | \$2208 | \$2285 | \$2353 |
| | 65"H x 24"W x 24"D, Wardrobe Right | HSTP652424RFFM | 178 | 27.2 | \$2208 | \$2285 | \$2353 |
| | 50"H x 24"W x 24"D, Wardrobe Left | HSTP502424LFFM | 146 | 21.1 | \$2065 | \$2142 | \$2210 |
| | 50"H x 24"W x 24"D, Wardrobe Right | HSTP502424RFFM | 146 | 21.1 | \$2065 | \$2142 | \$2210 |
| | 42"H x 24"W x 24"D, Wardrobe Left | HSTP422424LFFM | 132 | 16.8 | \$1765 | \$1815 | \$1890 |
| | 42"H x 24"W x 24"D, Wardrobe Right | HSTP422424RFFM | 132 | 16.8 | \$1765 | \$1815 | \$1890 |

NOTES:

- Metal chassis and drawer fronts.
- Steel frame provides durability.
- Leveling glides can be adjusted from outside or inside the case.
- Heavy-duty, telescoping ball-bearing slides.
- Baked, epoxy/polyester, powder coating finish.
- One lock secures doors and drawers.
- Pencil tray standard in top box drawer.
- One box divider standard in each box drawer.
- One crossrail standard in each file drawer.

! Locking units equipped with HON "One Key" interchangeable core removable locks. Keyed alike core model HF23S, in Satin, must be ordered separately. See page 675.

HOW TO SPECIFY

| Select Model Number | Select Base | Select Pull | Select Case Paint | Select Front Paint | Select Lock |
|-------------------------------|---|--|-------------------|------------------------|---|
| | BK Flush Plinth BX Recessed Plinth | A Arch PRO Silver R Radius N Integral S Square PR6 Silver | See page 666 | NA Matches Case | L Standard Lock X Omit Lock (- \$20) |
| H S T P 6 5 2 4 2 4 L F F M . | B X . | S P R 6 . | P 7 T . | N A . | L |

EMPOWER® Contain® Metal Side Access Towers

GSA SIN 33721



Icon Legend on page 19

WORKSTATIONS

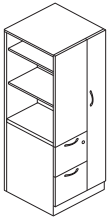
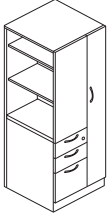

| DESCRIPTION | MODEL | SHIP WEIGHT | CUBE | LIST PRICE BY PAINT GRADE | | |
|--|-------------------------|-------------|------|---------------------------|---------------|---------------|
| | | | | P1 | P2 | P3 |
| Side Access Tower with Metal Fronts, Shelves/Box/Box/File | | | | | | |
| 65"H x 24"W x 24"D, Wardrobe Left | HSTSP652424LBBFM | 178 | 27.2 | \$2399 | \$2476 | \$2544 |
| 65"H x 24"W x 24"D, Wardrobe Right | HSTSP652424RBBFM | 178 | 27.2 | \$2399 | \$2476 | \$2544 |
| 50"H x 24"W x 24"D, Wardrobe Left | HSTSP502424LBBFM | 146 | 21.2 | \$2247 | \$2324 | \$2392 |
| 50"H x 24"W x 24"D, Wardrobe Right | HSTSP502424RBBFM | 146 | 21.2 | \$2247 | \$2324 | \$2392 |
| 42"H x 24"W x 24"D, Wardrobe Left | HSTSP422424LBBFM | 132 | 16.8 | \$2027 | \$2077 | \$2152 |
| 42"H x 24"W x 24"D, Wardrobe Right | HSTSP422424RBBFM | 132 | 16.8 | \$2027 | \$2077 | \$2152 |
| Side Access Tower with Metal Fronts, Shelves/File/File | | | | | | |
| 65"H x 24"W x 24"D, Wardrobe Left | HSTSP652424LFFM | 178 | 27.2 | \$2344 | \$2421 | \$2489 |
| 65"H x 24"W x 24"D, Wardrobe Right | HSTSP652424RFFM | 178 | 27.2 | \$2344 | \$2421 | \$2489 |
| 50"H x 24"W x 24"D, Wardrobe Left | HSTSP502424LFFM | 146 | 21.2 | \$2190 | \$2267 | \$2335 |
| 50"H x 24"W x 24"D, Wardrobe Right | HSTSP502424RFFM | 146 | 21.2 | \$2190 | \$2267 | \$2335 |
| 42"H x 24"W x 24"D, Wardrobe Left | HSTSP422424LFFM | 132 | 16.8 | \$1971 | \$2021 | \$2096 |
| 42"H x 24"W x 24"D, Wardrobe Right | HSTSP422424RFFM | 132 | 16.8 | \$1971 | \$2021 | \$2096 |

NOTES:

- Towers can be used to support a worksurface. In order to do so, order bracket model HSTB2W1.
- Metal chassis and drawer fronts.
- Steel frame provides durability.
- Leveling glides can be adjusted from outside or inside the case.
- Heavy-duty, telescoping ball-bearing slides.
- Baked, epoxy/polyester, powder coating finish.
- One lock secures doors and drawers.
- Pencil tray standard in top box drawer.
- One box divider standard in each box drawer.
- One crossrail standard in each file drawer.

ⓘ Locking units equipped with HON "One Key" interchangeable core removable locks. Keyed alike core model HF23S, in Satin, must be ordered separately. See page 675.

HOW TO SPECIFY

| | | | | | | |
|--|--|---|--|--|--|--|
| <p>Select Model Number</p> <p>H S T S P 6 5 2 4 2 4 L F F M .</p> | <p>Select Base</p> <p>BK Flush Plinth BX Recessed Plinth</p> <p>B X .</p> | <p>Select Pull</p> <p>A Arch PRO Silver R Radius N Integral S Square PR6 Silver</p> <p>S P R 6 .</p> | <p>Select Case Paint</p> <p>See page 666</p> <p>P 7 T .</p> | <p>Select Front Paint</p> <p>NA Matches Case</p> <p>N A .</p> | <p>Select Panel Paint</p> <p>NA Matches Case</p> <p>N A .</p> | <p>Select Lock</p> <p>L Standard X Lock Omit Lock (- \$20)</p> <p>L</p> |
|--|--|---|--|--|--|--|



Icon Legend on page 19

Contain® Metal Personal Towers with Laminate Fronts

| | DESCRIPTION | MODEL | SHIP WEIGHT | CUBE | LIST PRICE BY PAINT GRADE | | |
|--|---|------------------------|-------------|------|---------------------------|---------------|---------------|
| | | | | | P1 | P2 | P3 |
| | Personal Tower with Laminate Fronts, Door/Box/Box/File | | | | | | |
| | 65”H x 24”W x 24”D, Wardrobe Left | HSTP652424LBBFL | 178 | 27.2 | \$2595 | \$2672 | \$2740 |
| | 65”H x 24”W x 24”D, Wardrobe Right | HSTP652424RBBFL | 178 | 27.2 | \$2595 | \$2672 | \$2740 |
| | 50”H x 24”W x 24”D, Wardrobe Left | HSTP502424LBBFL | 146 | 21.2 | \$2430 | \$2507 | \$2575 |
| | 50”H x 24”W x 24”D, Wardrobe Right | HSTP502424RBBFL | 146 | 21.2 | \$2430 | \$2507 | \$2575 |
| | 42”H x 24”W x 24”D, Wardrobe Left | HSTP422424LBBFL | 132 | 16.8 | \$2086 | \$2136 | \$2211 |
| | 42”H x 24”W x 24”D, Wardrobe Right | HSTP422424RBBFL | 132 | 16.8 | \$2086 | \$2136 | \$2211 |
| | Personal Tower with Laminate Fronts, Door/File/File | | | | | | |
| | 65”H x 24”W x 24”D, Wardrobe Left | HSTP652424LFFL | 178 | 27.2 | \$2539 | \$2616 | \$2684 |
| | 65”H x 24”W x 24”D, Wardrobe Right | HSTP652424RFFL | 178 | 27.2 | \$2539 | \$2616 | \$2684 |
| | 50”H x 24”W x 24”D, Wardrobe Left | HSTP502424LFFL | 146 | 21.2 | \$2374 | \$2451 | \$2519 |
| | 50”H x 24”W x 24”D, Wardrobe Right | HSTP502424RFFL | 146 | 21.2 | \$2374 | \$2451 | \$2519 |
| | 42”H x 24”W x 24”D, Wardrobe Left | HSTP422424LFFL | 132 | 16.8 | \$2029 | \$2079 | \$2154 |
| | 42”H x 24”W x 24”D, Wardrobe Right | HSTP422424RFFL | 132 | 16.8 | \$2029 | \$2079 | \$2154 |

NOTES:

- Metal chassis with laminate drawer/door fronts.
- Steel frame provides durability.
- Leveling glides can be adjusted from outside or inside the case.
- Heavy-duty, telescoping ball-bearing slides.
- Baked, epoxy/polyester, powder coating finish.
- One lock secures doors and drawers.
- Pencil tray standard in top box drawer.
- One box divider standard in each box drawer.
- One crossrail standard in each file drawer.

! Locking units equipped with HON “One Key” interchangeable core removable locks. Keyed alike core model HF23S, in Satin, must be ordered separately. See page 675.

HOW TO SPECIFY

| | | | | | |
|-------------------------------|---------------------------|--|--------------------------|------------------------|---|
| Select Model Number | Select Base | Select Pull | Select Case Paint | Select Laminate | Select Lock |
| | BX Recessed Plinth | A Arch PRO Silver S Square PR6 Silver | See page 666 | See page 666 | L Standard Lock X Omit Lock (- \$20) |
| H S T P 6 5 2 4 2 4 L F F L . | B X . | S P R 6 . | P 7 T . | L S A 1 . | L |

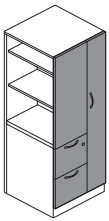
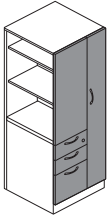

| DESCRIPTION | MODEL | SHIP WEIGHT | CUBE | LIST PRICE BY PAINT GRADE | | |
|---|-------------------------|-------------|------|---------------------------|---------------|---------------|
| | | | | P1 | P2 | P3 |
| Side Access Tower with Laminate Fronts, Shelves/Box/Box/File | | | | | | |
| 65"H x 24"W x 24"D, Wardrobe Left | HSTSP652424LBBFL | 178 | 27.2 | \$2750 | \$2827 | \$2895 |
| 65"H x 24"W x 24"D, Wardrobe Right | HSTSP652424RBBFL | 178 | 27.2 | \$2750 | \$2827 | \$2895 |
| 50"H x 24"W x 24"D, Wardrobe Left | HSTSP502424LBBFL | 146 | 21.2 | \$2574 | \$2651 | \$2719 |
| 50"H x 24"W x 24"D, Wardrobe Right | HSTSP502424RBBFL | 146 | 21.2 | \$2574 | \$2651 | \$2719 |
| 42"H x 24"W x 24"D, Wardrobe Left | HSTSP422424LBBFL | 132 | 16.8 | \$2322 | \$2372 | \$2447 |
| 42"H x 24"W x 24"D, Wardrobe Right | HSTSP422424RBBFL | 132 | 16.8 | \$2322 | \$2372 | \$2447 |
| Side Access Tower with Laminate Fronts, Shelves/File/File | | | | | | |
| 65"H x 24"W x 24"D, Wardrobe Left | HSTSP652424LFFL | 178 | 27.2 | \$2695 | \$2772 | \$2840 |
| 65"H x 24"W x 24"D, Wardrobe Right | HSTSP652424RFFL | 178 | 27.2 | \$2695 | \$2772 | \$2840 |
| 50"H x 24"W x 24"D, Wardrobe Left | HSTSP502424LFFL | 146 | 21.2 | \$2519 | \$2596 | \$2664 |
| 50"H x 24"W x 24"D, Wardrobe Right | HSTSP502424RFFL | 146 | 21.2 | \$2519 | \$2596 | \$2664 |
| 42"H x 24"W x 24"D, Wardrobe Left | HSTSP422424LFFL | 132 | 16.8 | \$2267 | \$2317 | \$2392 |
| 42"H x 24"W x 24"D, Wardrobe Right | HSTSP422424RFFL | 132 | 16.8 | \$2267 | \$2317 | \$2392 |

NOTES:

- Towers can be used to support a worksurface. In order to do so, order bracket model HSTB2W1.
- Metal chassis with laminate drawer/door fronts.
- Steel frame provides durability.
- Leveling glides can be adjusted from outside or inside the case.
- Heavy-duty, telescoping ball-bearing slides.
- Baked, epoxy/polyester, powder coating finish.
- One lock secures doors and drawers.
- Pencil tray standard in top box drawer.
- One box divider standard in each box drawer.
- One crossrail standard in each file drawer.

ⓘ Locking units equipped with HON "One Key" interchangeable core removable locks. Keyed alike core model HF23S, in Satin, must be ordered separately. See page 675.

HOW TO SPECIFY

| | | | | | |
|--|--|---|--|--|--|
| <p>Select Model Number</p> <p>H S T S P 6 5 2 4 2 4 L F F L .</p> | <p>Select Base</p> <p>BX Recessed Plinth</p> <p>B X .</p> | <p>Select Pull</p> <p>A Arch PRO Silver S Square PR6 Silver</p> <p>S P R 6 .</p> | <p>Select Case Paint</p> <p>See page 666</p> <p>P 7 T .</p> | <p>Select Laminate</p> <p>See page 666</p> <p>L S A 1 .</p> | <p>Select Lock</p> <p>L Standard Lock X Omit Lock (- \$20)</p> <p>L</p> |
|--|--|---|--|--|--|



Icon Legend on page 19

Contain® Footed Metal Personal Towers

| | DESCRIPTION | MODEL | SHIP WEIGHT | CUBE | LIST PRICE BY PAINT GRADE | | |
|--|---|------------------------|-------------|------|---------------------------|---------------|---------------|
| | | | | | P1 | P2 | P3 |
| | Footed Personal Tower with Metal Fronts, Door/Box/Box/File | | | | | | |
| | 65”H x 24”W x 24”D, Wardrobe Left | HSTF652424LBBFM | 178 | 25.8 | \$2399 | \$2476 | \$2544 |
| | 65”H x 24”W x 24”D, Wardrobe Right | HSTF652424RBBFM | 178 | 25.8 | \$2399 | \$2476 | \$2544 |
| | 50”H x 24”W x 24”D, Wardrobe Left | HSTF502424LBBFM | 146 | 19.8 | \$2255 | \$2332 | \$2400 |
| | 50”H x 24”W x 24”D, Wardrobe Right | HSTF502424RBBFM | 146 | 19.8 | \$2255 | \$2332 | \$2400 |
| | 42”H x 24”W x 24”D, Wardrobe Left | HSTF422424LBBFM | 132 | 18.2 | \$1955 | \$2005 | \$2080 |
| | 42”H x 24”W x 24”D, Wardrobe Right | HSTF422424RBBFM | 132 | 18.2 | \$1955 | \$2005 | \$2080 |
| | Footed Personal Tower with Metal Fronts, Door/File/File | | | | | | |
| | 65”H x 24”W x 24”D, Wardrobe Left | HSTF652424LFFM | 178 | 25.8 | \$2344 | \$2421 | \$2489 |
| | 65”H x 24”W x 24”D, Wardrobe Right | HSTF652424RFFM | 178 | 25.8 | \$2344 | \$2421 | \$2489 |
| | 50”H x 24”W x 24”D, Wardrobe Left | HSTF502424LFFM | 146 | 19.8 | \$2199 | \$2276 | \$2344 |
| | 50”H x 24”W x 24”D, Wardrobe Right | HSTF502424RFFM | 146 | 19.8 | \$2199 | \$2276 | \$2344 |
| | 42”H x 24”W x 24”D, Wardrobe Left | HSTF422424LFFM | 132 | 18.2 | \$1900 | \$1950 | \$2025 |
| | 42”H x 24”W x 24”D, Wardrobe Right | HSTF422424RFFM | 132 | 18.2 | \$1900 | \$1950 | \$2025 |

NOTES:

- Metal chassis and drawer fronts.
- Steel frame provides durability.
- Leveling glides can be adjusted from outside or inside the case.
- Heavy-duty, telescoping ball-bearing slides.
- Baked, epoxy/polyester, powder coating finish.
- One lock secures doors and drawers.
- Pencil tray standard in top box drawer.
- One box divider standard in each box drawer.
- One crossrail standard in each file drawer.

! Locking units equipped with HON “One Key” interchangeable core removable locks. Keyed alike core model HF23S, in Satin, must be ordered separately. See page 675.

HOW TO SPECIFY

| | | | | | |
|--|---|---|---|--|--|
| <p>Select Model Number</p> <p>H S T F 4 2 2 4 2 4 L B B F M .</p> | <p>Select Foot</p> <p>SF Contain Foot T1 Platinum Metallic PR6 Silver</p> <p>S F T 1 .</p> | <p>Select Pull</p> <p>A Arch PRO Silver R Radius N Integral S Square PR6 Silver</p> <p>S P R 6 .</p> | <p>Select Paint Color</p> <p>See page 666</p> <p>P 7 T .</p> | <p>Select Front Paint</p> <p>NA Matches Case</p> <p>N A .</p> | <p>Select Lock</p> <p>L Standard Lock X Omit Lock (- \$20)</p> <p>L</p> |
|--|---|---|---|--|--|



Icon Legend on page 19

WORKSTATIONS

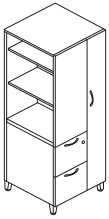
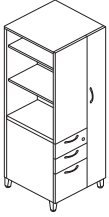

| DESCRIPTION | MODEL | SHIP WEIGHT | CUBE | LIST PRICE BY PAINT GRADE | | |
|---|-------------------------|-------------|------|---------------------------|---------------|---------------|
| | | | | P1 | P2 | P3 |
| Footed Side Access Tower with Metal Fronts, Shelves/Box/Box/File | | | | | | |
| 65"H x 24"W x 24"D, Wardrobe Left | HSTSF652424LBBFM | 178 | 25.8 | \$2534 | \$2611 | \$2679 |
| 65"H x 24"W x 24"D, Wardrobe Right | HSTSF652424RBBFM | 178 | 25.8 | \$2534 | \$2611 | \$2679 |
| 50"H x 24"W x 24"D, Wardrobe Left | HSTSF502424LBBFM | 146 | 19.8 | \$2380 | \$2457 | \$2525 |
| 50"H x 24"W x 24"D, Wardrobe Right | HSTSF502424RBBFM | 146 | 19.8 | \$2380 | \$2457 | \$2525 |
| 42"H x 24"W x 24"D, Wardrobe Left | HSTSF422424LBBFM | 132 | 18.2 | \$2162 | \$2212 | \$2287 |
| 42"H x 24"W x 24"D, Wardrobe Right | HSTSF422424RBBFM | 132 | 18.2 | \$2162 | \$2212 | \$2287 |
| Footed Side Access Tower with Metal Fronts, Shelves/File/File | | | | | | |
| 65"H x 24"W x 24"D, Wardrobe Left | HSTSF652424LFFM | 178 | 25.8 | \$2478 | \$2555 | \$2623 |
| 65"H x 24"W x 24"D, Wardrobe Right | HSTSF652424RFFM | 178 | 25.8 | \$2478 | \$2555 | \$2623 |
| 50"H x 24"W x 24"D, Wardrobe Left | HSTSF502424LFFM | 146 | 19.8 | \$2324 | \$2401 | \$2469 |
| 50"H x 24"W x 24"D, Wardrobe Right | HSTSF502424RFFM | 146 | 19.8 | \$2324 | \$2401 | \$2469 |
| 42"H x 24"W x 24"D, Wardrobe Left | HSTSF422424LFFM | 132 | 18.2 | \$2106 | \$2156 | \$2231 |
| 42"H x 24"W x 24"D, Wardrobe Right | HSTSF422424RFFM | 132 | 18.2 | \$2106 | \$2156 | \$2231 |

NOTES:

- Towers can be used to support a worksurface. In order to do so, order bracket model HSTB2W1.
- Metal chassis and drawer fronts.
- Steel frame provides durability.
- Leveling glides can be adjusted from outside or inside the case.
- Heavy-duty, telescoping ball-bearing slides.
- Baked, epoxy/polyester, powder coating finish.
- One lock secures doors and drawers.
- Pencil tray standard in top box drawer.
- One box divider standard in each box drawer.
- One crossrail standard in each file drawer.

! Locking units equipped with HON "One Key" interchangeable core removable locks. Keyed alike core model HF23S, in Satin, must be ordered separately. See page 675.

HOW TO SPECIFY

| | | | | | | |
|--|---|---|---|--|--|--|
| <p>Select Model Number</p> <p>H S T S F 4 2 2 4 2 4 R B B F M</p> | <p>Select Foot</p> <p>SF Contain Foot T1 Platinum Metallic PR6 Silver</p> <p>S F T 1</p> | <p>Select Pull</p> <p>A Arch PRO Silver R Radius N Integral S Square PR6 Silver</p> <p>S P R 6</p> | <p>Select Paint Color</p> <p>See page 666</p> <p>P 7 T</p> | <p>Select Front Paint</p> <p>NA Matches Case</p> <p>N A</p> | <p>Select Panel Paint</p> <p>NA Matches Case</p> <p>N A</p> | <p>Select Lock</p> <p>L Standard X Lock Omit Lock (- \$20)</p> <p>L</p> |
|--|---|---|---|--|--|--|



Icon Legend on page 19

Contain® Footed Metal Personal Towers with Laminate Fronts

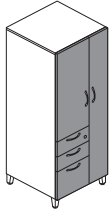

| DESCRIPTION | MODEL | SHIP WEIGHT | CUBE | LIST PRICE BY PAINT GRADE | | |
|--|------------------------|-------------|------|---------------------------|---------------|---------------|
| | | | | P1 | P2 | P3 |
| Footed Personal Tower with Laminate Fronts, Door/Box/Box/File | | | | | | |
| 65"H x 24"W x 24"D, Wardrobe Left | HSTF652424LBBFL | 178 | 25.8 | \$2730 | \$2807 | \$2875 |
| 65"H x 24"W x 24"D, Wardrobe Right | HSTF652424RBBFL | 178 | 25.8 | \$2730 | \$2807 | \$2875 |
| 50"H x 24"W x 24"D, Wardrobe Left | HSTF502424LBBFL | 146 | 19.8 | \$2564 | \$2641 | \$2709 |
| 50"H x 24"W x 24"D, Wardrobe Right | HSTF502424RBBFL | 146 | 19.8 | \$2564 | \$2641 | \$2709 |
| 42"H x 24"W x 24"D, Wardrobe Left | HSTF422424LBBFL | 132 | 18.2 | \$2220 | \$2270 | \$2345 |
| 42"H x 24"W x 24"D, Wardrobe Right | HSTF422424RBBFL | 132 | 18.2 | \$2220 | \$2270 | \$2345 |

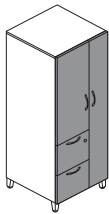

| | | | | | | |
|---|-----------------------|-----|------|---------------|---------------|---------------|
| Footed Personal Tower with Laminate Fronts, Door/File/File | | | | | | |
| 65"H x 24"W x 24"D, Wardrobe Left | HSTF652424LFFL | 178 | 25.8 | \$2674 | \$2751 | \$2819 |
| 65"H x 24"W x 24"D, Wardrobe Right | HSTF652424RFFL | 178 | 25.8 | \$2674 | \$2751 | \$2819 |
| 50"H x 24"W x 24"D, Wardrobe Left | HSTF502424LFFL | 146 | 19.8 | \$2507 | \$2584 | \$2652 |
| 50"H x 24"W x 24"D, Wardrobe Right | HSTF502424RFFL | 146 | 19.8 | \$2507 | \$2584 | \$2652 |
| 42"H x 24"W x 24"D, Wardrobe Left | HSTF422424LFFL | 132 | 18.2 | \$2165 | \$2215 | \$2290 |
| 42"H x 24"W x 24"D, Wardrobe Right | HSTF422424RFFL | 132 | 18.2 | \$2165 | \$2215 | \$2290 |

NOTES:

- Metal chassis with laminate drawer/door fronts.
- Steel frame provides durability.
- Leveling glides can be adjusted from outside or inside the case.
- Heavy-duty, telescoping ball-bearing slides.
- Baked, epoxy/polyester, powder coating finish.
- One lock secures doors and drawers.
- Pencil tray standard in top box drawer.
- One box divider standard in each box drawer.
- One crossrail standard in each file drawer.

! Locking units equipped with HON "One Key" interchangeable core removable locks. Keyed alike core model HF23S, in Satin, must be ordered separately. See page 675.

HOW TO SPECIFY

| | | | | | |
|---|---|--|---|---|--|
| Select Model Number H S T F 6 5 2 4 2 4 L B B F L . | Select Foot SF Contain Foot T1 Platinum Metallic PR6 Silver | Select Pull A Arch PRO Silver S Square PR6 Silver | Select Case Paint See page 666 P 7 T . | Select Laminate See page 666 L S A 1 . | Select Lock L Standard Lock X Omit Lock (- \$20) L |
|---|---|--|---|---|--|

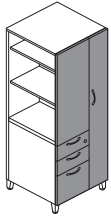

| DESCRIPTION | MODEL | SHIP WEIGHT | CUBE | LIST PRICE BY PAINT GRADE | | |
|--|-------------------------|-------------|------|---------------------------|---------------|---------------|
| | | | | P1 | P2 | P3 |
| Footed Side Access Tower with Laminate Fronts, Shelves/Box/Box/File | | | | | | |
| 65"H x 24"W x 24"D, Wardrobe Left | HSTSF652424LBBFL | 178 | 25.8 | \$2885 | \$2962 | \$3030 |
| 65"H x 24"W x 24"D, Wardrobe Right | HSTSF652424RBBFL | 178 | 25.8 | \$2885 | \$2962 | \$3030 |
| 50"H x 24"W x 24"D, Wardrobe Left | HSTSF502424LBBFL | 146 | 19.8 | \$2709 | \$2786 | \$2854 |
| 50"H x 24"W x 24"D, Wardrobe Right | HSTSF502424RBBFL | 146 | 19.8 | \$2709 | \$2786 | \$2854 |
| 42"H x 24"W x 24"D, Wardrobe Left | HSTSF422424LBBFL | 132 | 18.2 | \$2457 | \$2507 | \$2582 |
| 42"H x 24"W x 24"D, Wardrobe Right | HSTSF422424RBBFL | 132 | 18.2 | \$2457 | \$2507 | \$2582 |

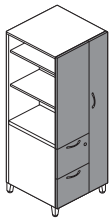

| | | | | | | |
|---|------------------------|-----|------|---------------|---------------|---------------|
| Footed Side Access Tower with Laminate Fronts, Shelves/File/File | | | | | | |
| 65"H x 24"W x 24"D, Wardrobe Left | HSTSF652424LFFL | 178 | 25.8 | \$2829 | \$2906 | \$2974 |
| 65"H x 24"W x 24"D, Wardrobe Right | HSTSF652424RFFL | 178 | 25.8 | \$2829 | \$2906 | \$2974 |
| 50"H x 24"W x 24"D, Wardrobe Left | HSTSF502424LFFL | 146 | 19.8 | \$2653 | \$2730 | \$2798 |
| 50"H x 24"W x 24"D, Wardrobe Right | HSTSF502424RFFL | 146 | 19.8 | \$2653 | \$2730 | \$2798 |
| 42"H x 24"W x 24"D, Wardrobe Left | HSTSF422424LFFL | 132 | 18.2 | \$2400 | \$2450 | \$2525 |
| 42"H x 24"W x 24"D, Wardrobe Right | HSTSF422424RFFL | 132 | 18.2 | \$2400 | \$2450 | \$2525 |

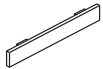

| | | | | | | |
|---|---------------|---|-----|--------------|--------------|--------------|
| Tower Kickplates (Field Installable) | | | | | | |
| For 24" Tower, Left | HSTAKL | 2 | 0.3 | \$179 | \$187 | \$192 |
| For 24" Tower, Right | HSTAKR | 2 | 0.3 | \$179 | \$187 | \$192 |

Specify: Model.Paint

SPECIFYING EXAMPLE: HSATKL.P

NOTES:

- Towers can be used to support a worksurface. In order to do so, order bracket model HSTB2W1.
- Metal chassis with laminate drawer/door fronts.
- Steel frame provides durability.
- Leveling glides can be adjusted from outside or inside the case.
- Heavy-duty, telescoping ball-bearing slides.
- Baked, epoxy/polyester, powder coating finish.
- One lock secures doors and drawers.
- Pencil tray standard in top box drawer.
- One box divider standard in each box drawer.
- One crossrail standard in each file drawer.

⚠ Locking units equipped with HON "One Key" interchangeable core removable locks. Keyed alike core model HF23S, in Satin, must be ordered separately. See page 675.

HOW TO SPECIFY

| | | | | | |
|--|---|---|--|--|--|
| <p>Select Model Number</p> <p>H S T S F 6 5 2 4 2 4 L B B F L</p> | <p>Select Foot</p> <p>SF Contain Foot T1 Platinum Metallic PR6 Silver</p> <p>S F T 1</p> | <p>Select Pull</p> <p>A Arch PRO Silver S Square PR6 Silver</p> <p>S P R 6</p> | <p>Select Case Paint</p> <p>See page 666</p> <p>P 7 T</p> | <p>Select Laminate</p> <p>See page 666</p> <p>L S A 1</p> | <p>Select Lock</p> <p>L Standard Lock X Omit Lock (- \$20)</p> <p>L</p> |
|--|---|---|--|--|--|



Icon Legend on page 19

EMPOWER[®] Contain[®] Metal Pedestals

WORKSTATIONS

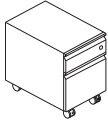

| DESCRIPTION | MODEL | SHIP WEIGHT | CUBE | LIST PRICE BY PAINT GRADE | | |
|--|-------------------------|-------------|------|---------------------------|--------------|--------------|
| | | | | P1 | P2 | P3 |
| Mobile Pedestal with Metal Fronts, Box/File | | | | | | |
| 21"H x 15"W x 18"D | HSPM211518BFM(?) | 63.5 | 4.4 | \$627 | \$655 | \$683 |
| 21"H x 15"W x 24"D | HSPM211524BFM(?) | 61.9 | 5.7 | \$673 | \$701 | \$729 |

NOTES: Ball-bearing suspension on box and file drawer. (100%) Drawers color to be interior gray steel. See page 568 for Pedestal Seat. File drawer has high sides and back for filing front-to-back and side-to-side. Counterweight standard on all mobile peds. Optional steel tops and pedestal seat cushions available. See pages 566 and 569. Pencil tray standard in top box drawer. One box divider standard in each box drawer. One crossrail standard in each file drawer.

- ! Available drawer fronts; R-Pull, A-Pull and N-Pull. A-Pull available in Satin Chrome only.
- ! Peds come with a plinth base, footed base or mobile base.

HOW TO SPECIFY

| | | |
|--|---|---|
| <p>Select Model Number</p> <p>Replace (?) with handle choice</p> <p>A Satin Chrome Arch N Full Face Integral R Full Radius</p> <p>H S P M 2 1 1 5 1 8 B F M A .</p> | <p>Select Paint Color</p> <p>See page 504 Contain[®] Storage finish options</p> <p>P .</p> | <p>Select Lock Option</p> <p>L Standard Lock X Omit Lock (deduct \$20)</p> <p>L</p> |
|--|---|---|

EMPOWER® Contain® Footed Metal Pedestals

GSA SIN 33721 EXCEPT AS NOTED



Icon Legend on page 19

WORKSTATIONS

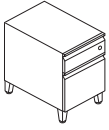

| DESCRIPTION | MODEL | SHIP WEIGHT | CUBE | LIST PRICE BY PAINT GRADE | | |
|---|---------------------------|-------------|------|---------------------------|--------------|--------------|
| | | | | P1 | P2 | P3 |
| Footed Freestanding Pedestal with Metal Fronts, Box/File | | | | | | |
| 22"H x 15"W x 18"D | HSPFSF221518BFM(?) | 66.8 | 4.4 | \$737 | \$765 | \$793 |
| 22"H x 15"W x 24"D | HSPFSF221524BFM(?) | 73.1 | 5.7 | \$779 | \$807 | \$835 |

NOTES: Ball-bearing suspension on box and file drawer. (100%) Drawers color to be interior gray steel. File drawer has high sides and back for filing front-to-back and side-to-side. Counterweight standard on all mobile peds. Optional steel tops and pedestal seat cushions available. See pages 566 and 569. Pencil tray standard in top box drawer. One box divider standard in each box drawer. One crossrail standard in each file drawer.

- Available drawer fronts; R-Pull, A-Pull and N-Pull. A-Pull available in Satin Chrome only.
- Peds come with a plinth base, footed base or mobile base.

| DESCRIPTION | MODEL | SHIP WEIGHT | CUBE | LIST PRICE |
|---|--------------|-------------|------|--------------|
| Counterweight — Freestanding Support Pedestals or Systems Support and Mobile Pedestals | HPCW1 | 18 | 0.1 | \$223 |

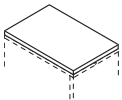

OPEN MARKET



| DESCRIPTION | MODEL | SHIP WEIGHT | CUBE | FABRIC PRICE CODES | | | |
|-----------------------|-------------------|-------------|------|--------------------|-------|----|-------|
| Pedestal Seat | | | | | | | |
| 15"W x 22 7/8"D x 2"H | HPSEAT24ND | 10 Ⓞ | 1.2 | 1 | \$222 | 8 | \$418 |
| | | | | 2 | \$246 | 9 | \$449 |
| | | | | 3 | \$270 | 10 | \$480 |
| | | | | 4 | \$294 | 11 | \$511 |
| | | | | 5 | \$325 | 12 | \$542 |
| | | | | 6 | \$356 | L | — |
| | | | | 7 | \$387 | | |

NOTES: For seating fabrics, see pages 22-24.
SPECIFYING EXAMPLE: HPSEAT24ND.APN23

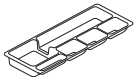

| DESCRIPTION | MODEL | SHIP WEIGHT | CUBE | LIST PRICE |
|-----------------------------|---------------|-------------|------|-------------|
| Optional Pencil Tray | HV-UT1 | 0.5 | 0.1 | \$77 |

NOTES: For additional information see the Workplace Tools section in the 2021 Shared Spaces Pricer.

- For use with mobile and freestanding pedestal models.
- No specification required.

HOW TO SPECIFY

Select Model Number

Replace (?) with handle choice

- A Satin Chrome Arch
- N Full Face Integral
- R Full Radius

H S P F S F 2 2 1 5 1 8 B F M A .

Select Paint Color

See page 504 Contain® Storage finish options

P .

Select Lock Option

- L Standard Lock
- X Omit Lock (deduct \$20)

L .

Select Foot Color

- T1 Platinum Metallic
- PR6 Silver

T 1



Icon Legend on page 19

Contain® Metal Pedestals with Laminate Fronts

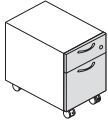

| DESCRIPTION | MODEL | SHIP WEIGHT | CUBE | LIST PRICE BY PAINT GRADE | | |
|---|-------------------------|-------------|------|---------------------------|--------------|--------------|
| | | | | P1 | P2 | P3 |
| Mobile Pedestal with Laminate Fronts, Box/File | | | | | | |
| 21"H x 15"W x 18"D, Arch Pull | HSPM211518BFL(?) | 65.3 | 4.4 | \$802 | \$830 | \$858 |
| 21"H x 15"W x 24"D, Arch Pull | HSPM211524BFL(?) | 63.7 | 5.7 | \$847 | \$875 | \$903 |

NOTES: Ball-bearing suspension on box and file drawer. (100%) Drawers color to be interior gray steel. File drawer has high sides and back for filing front-to-back and side-to-side. Counterweight standard on all mobile peds. See page 568 for Pedestal Seat. Optional pedestal seat cushions available. See page 569. Pencil tray standard in top box drawer. One box divider standard in each box drawer. One crossrail standard in each file drawer.

- ! Drawer Fronts available with Satin Chrome Arch only.
- ! Peds come with a plinth base, footed base or mobile base.

HOW TO SPECIFY

| | | | |
|---|--|---|--|
| <p>Select Model Number</p> <p>Replace (?) with handle choice</p> <p>A Satin Chrome Arch</p> | <p>Select Paint Color</p> <p>See page 504 Contain® Storage finish options</p> | <p>Select Lock Option</p> <p>L Standard Lock X Omit Lock (deduct \$20)</p> | <p>Select Laminate Option</p> <p>L1 (no upcharge)</p> <p>COGN Cognac C Harvest N Mahogany MOCH Mocha D Natural Maple PINC Pinnacle F Shaker Cherry</p> <p>L2 (\$10 upcharge)</p> <p>LLA1 Lowell Ash LNRI Natural Recon LPE1 Phantom Ecu LPT1 Portico Teak LSW1 Skyline Walnut</p> |
| <p>H S P M 2 1 1 5 1 8 B F L A .</p> | <p>P .</p> | <p>L .</p> | <p>C</p> |



Icon Legend on page 19

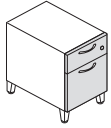

SIN 33721

| DESCRIPTION | MODEL | SHIP WEIGHT | CUBE | LIST PRICE BY PAINT GRADE | | |
|---|---------------------------|-------------|------|---------------------------|--------------|---------------|
| | | | | P1 | P2 | P3 |
| Footed Freestanding Pedestal with Laminate Fronts, Box/File 22"H x 15"W x 18"D, Arch Pull | HSPFSF221518BFL(?) | 69.0 | 4.4 | \$912 | \$940 | \$968 |
| 22"H x 15"W x 24"D, Arch Pull | HSPFSF221524BFL(?) | 75.3 | 5.7 | \$953 | \$981 | \$1009 |

NOTES: Ball-bearing suspension on box and file drawer. (100%) Drawers color to be interior gray steel. File drawer has high sides and back for filing front-to-back and side-to-side. Counterweight standard on all mobile peds. See below for pedestal seat. Optional pedestal seat cushions available. See page 569. Pencil tray standard in top box drawer. One box divider standard in each box drawer. One crossrail standard in each file drawer. See Brigade® pedestals on page 656 for additional pedestal options. See pages 750-751 for Pedestal Accessories.

- ❗ Drawer Fronts available with Satin Chrome Arch only.
- ❗ Peds come with a plinth base, footed base or mobile base.

HOW TO SPECIFY

| | | | | |
|---|--|---|---|--|
| <p>Select Model Number</p> <p>Replace (?) with handle choice</p> <p>A Satin Chrome Arch</p> | <p>Select Paint Color</p> <p>See page 504 Contain® Storage finish options</p> | <p>Select Lock Option</p> <p>L Standard Lock X Omit Lock (deduct \$20)</p> | <p>Select Laminate Option</p> <p>L1 (no upcharge)</p> <p>COGN Cognac C Harvest N Mahogany MOCH Mocha D Natural Maple PINC Pinnacle F Shaker Cherry</p> <p>L2 (\$10 upcharge)</p> <p>LLA1 Lowell Ash LNR1 Natural Recon LPE1 Phantom Ecrú LPT1 Portico Teak LSW1 Skyline Walnut</p> | <p>Select Foot Color</p> <p>T1 Platinum Metallic PR6 Silver</p> |
| <p>H S P F S F 2 2 1 5 1 8 B F L A .</p> | <p>P .</p> | <p>L .</p> | <p>C .</p> | <p>T 1</p> |

| DESCRIPTION | MODEL | SHIP WEIGHT | CUBE | FABRIC PRICE CODES | | | |
|--|-------------------|-------------|------|--------------------|--------------|-----------|--------------|
| Pedestal Seat 15"W x 22 ⁷ / ₈ "D x 2"H | HPSEAT24ND | 10 Ⓞ | 1.2 | 1 | \$222 | 8 | \$418 |
| NOTES: For seating fabrics, see pages 22-24. | | | | 2 | \$246 | 9 | \$449 |
| | | | | 3 | \$270 | 10 | \$480 |
| | | | | 4 | \$294 | 11 | \$511 |
| | | | | 5 | \$325 | 12 | \$542 |
| | | | | 6 | \$356 | L | — |
| | | | | 7 | \$387 | | |



HOW TO SPECIFY

| | |
|-----------------------------------|---|
| <p>Select Model Number</p> | <p>Select Fabric</p> <p>See pages 502-503 for seating fabric options</p> |
| <p>H P S E A T 2 4 .</p> | <p>A P N 2 3</p> |



Icon Legend on page 19

EMPOWER[®] Flagship[®] Mobile Pedestals

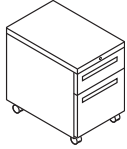

H15923N
SIN 33721

| DESCRIPTION | MODEL | SHIP WEIGHT | CUBE | LIST PRICE BY PAINT GRADE | | |
|---|-----------|-------------|------|---------------------------|-------|-------|
| | | | | P1 | P2 | P3 |
| Mobile Pedestals — Box/File 15"W x 22 ⁷ / ₈ "D x 22"H NOTES: Pencil tray standard in top box drawer. One box divider standard in each box drawer. One crossrail standard in each file drawer. File drawers have high sides for filing front-to-back. Steel ball-bearing suspension on file and box drawers. See pages 750-751 for accessories and pedestal utilization information. Arch pull available in Satin Chrome only. Choose from any of three pull options with no upcharge. Available in Arch (A), Full Face Integral (N) and Full Radius (R) Drawer Pulls. See page 653 for pull options. Equipped with HON "One Key" interchangeable core removable locks. Counterweight standard. Omit lock-option available. See page 773 for ordering instructions. See Brigade [®] pedestals on page 656 for additional pedestal options. See pages 750-751 for Pedestal Accessories. | H15923(?) | 92 | 6.0 | \$663 | \$691 | \$719 |

HOW TO SPECIFY

| | | |
|---|---|--|
| Select Model Number A Satin Chrome Arch N Full Face Integral R Full Radius H 1 5 9 2 3 A . | Select Lock Option L Lock (no upcharge) X Omit Lock (deduct \$20) X . | Select Paint Color See page 504 T 1 |
|---|---|--|

| DESCRIPTION | MODEL | SHIP WEIGHT | CUBE | FABRIC PRICE CODES | | | |
|--|------------|-------------|------|--------------------|-------|----|-------|
| Pedestal Seat 15"W x 22 ⁷ / ₈ "D x 2"H NOTES: For seating fabrics, see pages 22-24. | HPSEAT24ND | 10 | 1.2 | 1 | \$222 | 8 | \$418 |
| | | | | 2 | \$246 | 9 | \$449 |
| | | | | 3 | \$270 | 10 | \$480 |
| | | | | 4 | \$294 | 11 | \$511 |
| | | | | 5 | \$325 | 12 | \$542 |
| | | | | 6 | \$356 | L | — |
| | | | | 7 | \$387 | | |

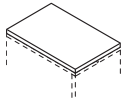

OPEN MARKET

HOW TO SPECIFY

| | |
|---|---|
| Select Model Number H P S E A T 2 4 . | Select Fabric See pages 502-503 for seating fabric options A P N 2 3 |
|---|---|

DESCRIPTION

MODEL SHIP WEIGHT CUBE LIST PRICE

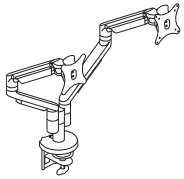

Dual Dynamic Monitor Arm

- 150° of rotation at base with optional 360° rotation.
- Arms extend 22" and retract up to 3".
- Monitor mount rotates 180° and tilts +/-30°.
- Monitor can be rotated from landscape to portrait position.

! Arms hold monitors from 6.2-18 lbs. Optional counterweight HPACW available to support monitors as low as 5 lbs. (see the Workplace Tools section in the 2021 Shared Spaces Pricer).

HMASD 17.0 1.1 \$962

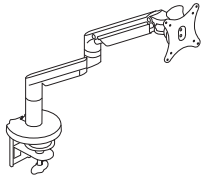

Single Dynamic Monitor Arm

- 180° of rotation at base with optional 360° rotation.
- Arms extend 22" and retract up to 3".
- Monitor mount rotates 180° and tilts +/-30°.
- Monitor can be rotated from landscape to portrait position.

! Arms hold monitors from 6.2-18 lbs. Optional counterweight HPACW available to support monitors as low as 5 lbs. (see the Workplace Tools section in the 2021 Shared Spaces Pricer).

HMASTS 11.5 0.8 \$501

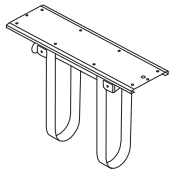

360° Swivel CPU Holder with Adjustable Straps

- Supports CPUs 3¾" wide up to 64" perimeter and holds up to 75 lbs.
- 360° rotation.
- Ships complete and includes necessary mounting hardware and instruction sheet.

! Available in Black only, no specification needed.

HCPU1 7.0 0.2 \$260

SIN 33721

NOTES:

- For additional information see the Workplace Tools section in the 2021 Shared Spaces Pricer.

Monitor Arms

- Arms fold back to post to allow more desktop room.
- Arms feature double extension, allowing 20"+ of back and forth movement.
- Cable management on both pole and arm assemblies.
- Counterbalance adjustment provides stability for monitors up to 17.6 lbs per arm.
- Made of high-quality aluminum alloy material.
- See the Workplace Tools section in the 2021 Shared Spaces Pricer for additional monitor arm models.

HOW TO SPECIFY

| | |
|-----------------------------------|--|
| <p>Select Model Number</p> | <p>Select Finish</p> <p><i>Specify for models HMASD and HMASTS only</i></p> <p>SVR Silver BLK Black</p> |
| <p>HMASD.</p> | <p>SVR</p> |

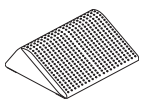

| | DESCRIPTION | MODEL | SHIP WEIGHT | CUBE | LIST PRICE |
|---|---|----------------------|-------------|------------|--------------------|
|  | <p>Footrest — Anti-Slip Cover 13³/₄"D x 5¹/₂"H x 16"W</p> <p>ⓘ Available in Black (T) finish ONLY. Recommended weight capacity not to exceed 250 pounds. HON 5-Year Limited Warranty. SPECIFYING EXAMPLE: HVL991.T</p> | <p>HVL991</p> | <p>7 Ⓞ</p> | <p>0.9</p> | <p>\$89</p> |

HOW TO SPECIFY

| | |
|---|--|
| <p>Select Model Number</p> <p>H V L 9 9 1 .</p> | <p>Select Finish</p> <p>T Black</p> <p>T</p> |
|---|--|

GRAVITATION™ POWER BEAM

Want to see more? Scan here
to check out hon.com.



WORKSTATIONS



Gravitation™ Power Beam shown with Coordinate™ Height Adjustable Tables, Fuse™ Storage, Astir™, Mav, and Solve® Seating.

GRAVITATION™ BEAM

Bringing power and privacy to individual workspaces and team areas, Gravitation™ Beam offers a sleek look and multiple aesthetic options to complement any environment. Designed for movement and flexibility, it adapts to changing needs with ease.



FEATURES

- Pairs perfectly with height adjustable tables or alongside soft seating.
- Offered in a variety of paint options.
- Available in 3 widths: 48", 60", and 72".
- Create L, X, and T configurations using universal connectors.
- Painted metal screens available to provide privacy and space division.

GRAVITATION™ POWER BEAM ORDERING INFORMATION

PAINT

PAINT CODES

P1

- ◆ Black P71
- ◆ Brownstone P7D
- ◆ Charcoal P02
- ◆ Designer White PJW
- ◆ Fossil P28
- ◆ Greige T5
- ◆ Loft LOFT
- ◆ Muslin T3
- ◆ Shadow * SHDW
- ◆ Titanium P8T

P2

- ◆ Champagne Metallic T4
- ◆ Silver PR6
- ◆ Solar Black P8X

P3

- ◆ Atom P8S
- ◆ Bullseye PJF
- ◆ Ember P8P
- ◆ Ion P8N
- ◆ Iris P8J
- ◆ Krypton P8F
- ◆ Regatta P8M

P6

- ◆ Markerboard MKB

Duplex Color Recommended to Coordinate with Paint Color

| Paint Color | Paint Code | Duplex Color | Duplex Code |
|--------------------|------------|----------------|-------------|
| Black | P | Black | P |
| Brownstone | P7D | Brownstone | EY |
| Charcoal | S | Charcoal | S |
| Designer White | PJW | Designer White | DW |
| Fossil | P28 | Charcoal | S |
| Greige | T5 | Muslin | T3 |
| Light Gray | Q | Loft | LOFT |
| Loft | LOFT | Loft | LOFT |
| Muslin | T3 | Muslin | T3 |
| Putty | L | Black | P |
| Shadow | SHDW | Muslin | T3 |
| Silver | PR6 | Titanium | TI |
| Titanium | P8T | Titanium | TI |
| Champagne Metallic | T4 | Muslin | T3 |
| Platinum Metallic | T1 | Titanium | TI |

◆◆◆ For lead time information see page 19.

* De-emphasized

GRAVITATION™ POWER BEAM ORDERING INFORMATION

Gravitation™ Ordering Checklist

When specifying Gravitation™ Power Beams for your workspace, follow the ordering checklist below to ensure full functionality.

- Beams (HBEAM48, 60, or 72).
- Legs to go with beams based on how the beams will be connected (HBLEG23).
- Electrical Harnesses, Receptacles, and In-feeds.
- Specify connectors, power hubs, and/or power poles (HBEORH23, HBEORT23, HBILNH23, HBCONU, etc.).
- Port Covers (for any power/data ports left unused).
- Metal Screens (if desired).

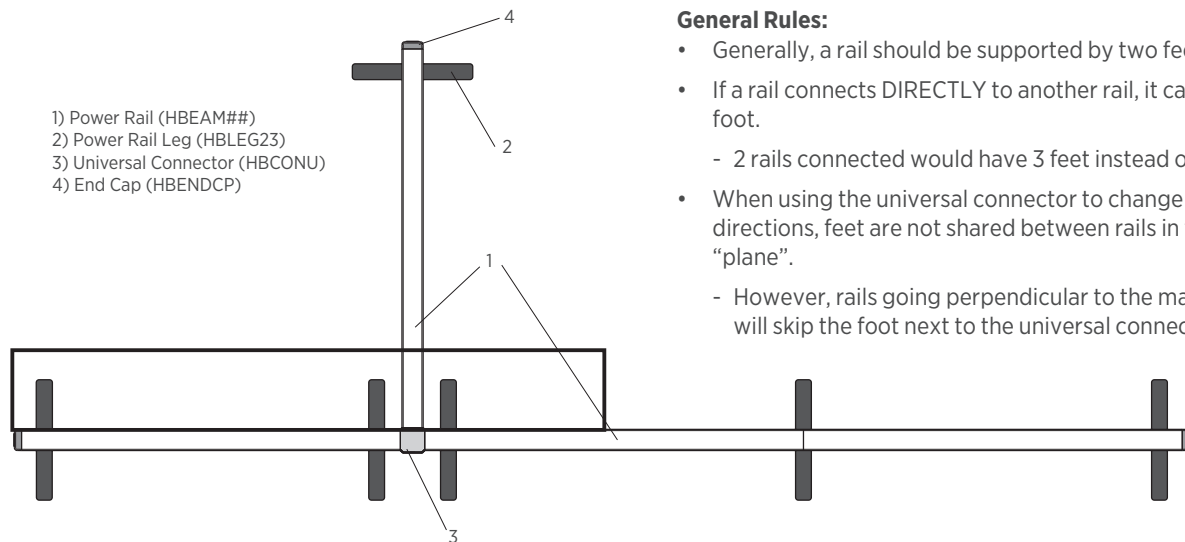

General Rules:

- Generally, a rail should be supported by two feet.
- If a rail connects DIRECTLY to another rail, it can share a foot.
 - 2 rails connected would have 3 feet instead of 4.
- When using the universal connector to change directions, feet are not shared between rails in the same “plane”.
 - However, rails going perpendicular to the main line will skip the foot next to the universal connector.

ⓘ When two rails share a leg, the leg is centered between the legs in the “outer slot”. When the leg is positioned **at the end of a run of rails** (i.e., the rail doesn’t connect to another rail), the leg will be inset 1/8” from the end of the rail, not the end cap, in the “inner slot”.

Cable Capacity

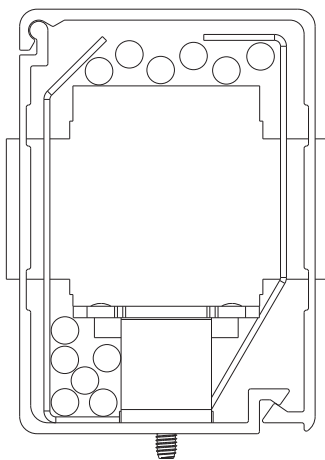

- The Power Rail housing allows continuous voice and data lines to run without interruption.
- Lay-in is provided for environments where systems furniture or cabling are subject to frequent change.
- Lower cavity allows for 6 voice/data cables (1/4” diameter).
- Upper cavity lay-in allows 6 voice/data cables (1/4” diameter).



Icon Legend on page 19

GRAVITATION™ 48"W Bundles

WORKSTATIONS

| QTY | DESCRIPTION | MODEL | LIST PRICE | PRICE EXTENSION |
|---------------|---------------------------------|----------|----------------|-----------------|
| 1 | Gravitation™ Power Beam 48"W | HBEAM48 | \$381 | \$381 |
| 2 | Gravitation™ Legs 23"H | HBLEG23 | \$133 | \$266 |
| 1 | End of Run Power Harness | HMPEEK48 | \$249 | \$249 |
| 4 | Duplexes | HH873501 | \$47 | \$188 |
| 2 | Gravitation™ Power Beam End Cap | HBENDCP | \$70 | \$140 |
| TOTAL: | | | \$1,224 | \$1,224 |

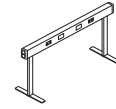

1-PACK — 48"W

| QTY | DESCRIPTION | BUNDLE SKU | LIST PRICE BY PAINT GRADE | | |
|-----|---------------|------------|---------------------------|---------|---------|
| | | | P1 | P2 | P3 |
| 1 | 1-PACK BUNDLE | HBDL148 | \$1,224 | \$1,295 | \$1,330 |

SPECIFYING EXAMPLE: Model.Paint

| QTY | DESCRIPTION | MODEL | LIST PRICE | PRICE EXTENSION |
|---------------|---------------------------------|----------|----------------|-----------------|
| 2 | Gravitation™ Power Beam 48"W | HBEAM48 | \$381 | \$762 |
| 3 | Gravitation™ Legs 23"H | HBLEG23 | \$133 | \$399 |
| 1 | End of Run Power Harness | HMPEEK48 | \$249 | \$249 |
| 1 | Power Harness | HH871248 | \$239 | \$239 |
| 4 | Duplexes | HH873501 | \$47 | \$188 |
| 4 | Duplexes | HH873502 | \$47 | \$188 |
| 2 | Gravitation™ Power Beam End Cap | HBENDCP | \$70 | \$140 |
| TOTAL: | | | \$2,165 | \$2,165 |

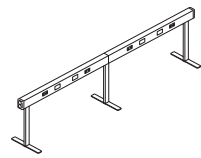

2-PACK — 48"W

| QTY | DESCRIPTION | BUNDLE SKU | LIST PRICE BY PAINT GRADE | | |
|-----|---------------|------------|---------------------------|---------|---------|
| | | | P1 | P2 | P3 |
| 1 | 2-PACK BUNDLE | HBDL248 | \$2,165 | \$2,283 | \$2,341 |

SPECIFYING EXAMPLE: Model.Paint

| QTY | DESCRIPTION | MODEL | LIST PRICE | PRICE EXTENSION |
|---------------|---------------------------------|----------|----------------|-----------------|
| 3 | Gravitation™ Power Beam 48"W | HBEAM48 | \$381 | \$1,143 |
| 4 | Gravitation™ Legs 23"H | HBLEG23 | \$133 | \$532 |
| 1 | End of Run Power Harness | HMPEEK48 | \$249 | \$249 |
| 2 | Power Harness | HH871248 | \$239 | \$478 |
| 4 | Duplexes | HH873501 | \$47 | \$188 |
| 4 | Duplexes | HH873502 | \$47 | \$188 |
| 4 | Duplexes | HH873503 | \$47 | \$188 |
| 2 | Gravitation™ Power Beam End Cap | HBENDCP | \$70 | \$140 |
| TOTAL: | | | \$3,106 | \$3,106 |

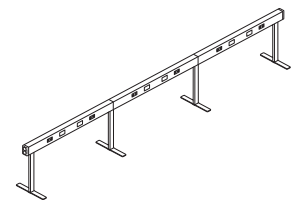

3-PACK — 48"W

| QTY | DESCRIPTION | BUNDLE SKU | LIST PRICE BY PAINT GRADE | | |
|-----|---------------|------------|---------------------------|---------|---------|
| | | | P1 | P2 | P3 |
| 1 | 3-PACK BUNDLE | HBDL348 | \$3,106 | \$3,271 | \$3,352 |

SPECIFYING EXAMPLE: Model.Paint

| QTY | DESCRIPTION | MODEL | LIST PRICE | PRICE EXTENSION |
|---------------|---------------------------------|----------|----------------|-----------------|
| 4 | Gravitation™ Power Beam 48"W | HBEAM48 | \$381 | \$1,524 |
| 5 | Gravitation™ Legs 23"H | HBLEG23 | \$133 | \$665 |
| 1 | End of Run Power Harness | HMPEEK48 | \$249 | \$249 |
| 3 | Power Harness | HH871248 | \$239 | \$717 |
| 4 | Duplexes | HH873502 | \$47 | \$188 |
| 4 | Duplexes | HH873503 | \$47 | \$188 |
| 4 | Duplexes | HH873504 | \$47 | \$188 |
| 2 | Gravitation™ Power Beam End Cap | HBENDCP | \$70 | \$140 |
| TOTAL: | | | \$3,859 | \$3,859 |

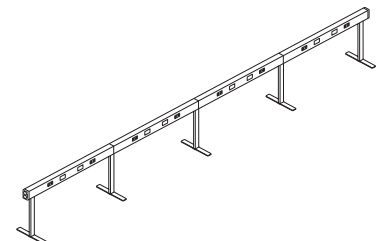

4-PACK — 48"W

| QTY | DESCRIPTION | BUNDLE SKU | LIST PRICE BY PAINT GRADE | | |
|-----|---------------|------------|---------------------------|---------|---------|
| | | | P1 | P2 | P3 |
| 1 | 4-PACK BUNDLE | HBDL448 | \$4,047 | \$4,259 | \$4,363 |

SPECIFYING EXAMPLE: Model.Paint

! Power in-feeds and port covers are not included in Bundles and must be specified separately.

GRAVITATION™ 60"W Bundles



Icon Legend on page 19

WORKSTATIONS

| QTY | DESCRIPTION | MODEL | LIST PRICE | PRICE EXTENSION |
|---------------|---------------------------------|----------|----------------|-----------------|
| 1 | Gravitation™ Power Beam 60"W | HBEAM60 | \$419 | \$419 |
| 2 | Gravitation™ Legs 23"H | HBLEG23 | \$133 | \$266 |
| 1 | End of Run Power Harness | HMPEEK60 | \$249 | \$249 |
| 4 | Duplexes | HH873501 | \$47 | \$188 |
| 2 | Gravitation™ Power Beam End Cap | HBENDCP | \$70 | \$140 |
| TOTAL: | | | \$1,262 | \$1,262 |

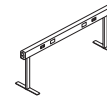

1-PACK — 60"W

| QTY | DESCRIPTION | BUNDLE SKU | LIST PRICE BY PAINT GRADE | | |
|-----|---------------|------------|---------------------------|---------|---------|
| | | | P1 | P2 | P3 |
| 1 | 1-PACK BUNDLE | HBDL160 | \$1,262 | \$1,336 | \$1,373 |

SPECIFYING EXAMPLE: Model.Paint

| QTY | DESCRIPTION | MODEL | LIST PRICE | PRICE EXTENSION |
|---------------|---------------------------------|----------|----------------|-----------------|
| 2 | Gravitation™ Power Beam 60"W | HBEAM60 | \$419 | \$838 |
| 3 | Gravitation™ Legs 23"H | HBLEG23 | \$133 | \$399 |
| 1 | End of Run Power Harness | HMPEEK60 | \$249 | \$249 |
| 1 | Power Harness | HH871260 | \$239 | \$239 |
| 4 | Duplexes | HH873501 | \$47 | \$188 |
| 4 | Duplexes | HH873502 | \$47 | \$188 |
| 2 | Gravitation™ Power Beam End Cap | HBENDCP | \$70 | \$140 |
| TOTAL: | | | \$2,241 | \$2,241 |

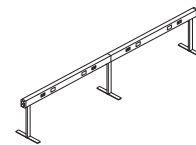

2-PACK — 60"W

| QTY | DESCRIPTION | BUNDLE SKU | LIST PRICE BY PAINT GRADE | | |
|-----|---------------|------------|---------------------------|---------|---------|
| | | | P1 | P2 | P3 |
| 1 | 2-PACK BUNDLE | HBDL260 | \$2,241 | \$2,365 | \$2,427 |

SPECIFYING EXAMPLE: Model.Paint

| QTY | DESCRIPTION | MODEL | LIST PRICE | PRICE EXTENSION |
|---------------|---------------------------------|----------|----------------|-----------------|
| 3 | Gravitation™ Power Beam 60"W | HBEAM60 | \$419 | \$1,257 |
| 4 | Gravitation™ Legs 23"H | HBLEG23 | \$133 | \$532 |
| 1 | End of Run Power Harness | HMPEEK60 | \$249 | \$249 |
| 2 | Power Harness | HH871260 | \$239 | \$478 |
| 4 | Duplexes | HH873501 | \$47 | \$188 |
| 4 | Duplexes | HH873502 | \$47 | \$188 |
| 4 | Duplexes | HH873503 | \$47 | \$188 |
| 2 | Gravitation™ Power Beam End Cap | HBENDCP | \$70 | \$140 |
| TOTAL: | | | \$3,220 | \$3,220 |

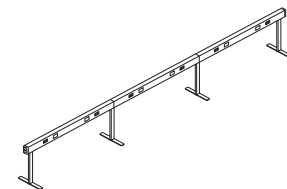

3-PACK — 60"W

| QTY | DESCRIPTION | BUNDLE SKU | LIST PRICE BY PAINT GRADE | | |
|-----|---------------|------------|---------------------------|---------|---------|
| | | | P1 | P2 | P3 |
| 1 | 3-PACK BUNDLE | HBDL360 | \$3,220 | \$3,394 | \$3,481 |

SPECIFYING EXAMPLE: Model.Paint

| QTY | DESCRIPTION | MODEL | LIST PRICE | PRICE EXTENSION |
|---------------|---------------------------------|----------|----------------|-----------------|
| 4 | Gravitation™ Power Beam 60"W | HBEAM60 | \$419 | \$1,676 |
| 5 | Gravitation™ Legs 23"H | HBLEG23 | \$133 | \$665 |
| 1 | End of Run Power Harness | HMPEEK60 | \$249 | \$249 |
| 3 | Power Harness | HH871260 | \$239 | \$717 |
| 4 | Duplexes | HH873502 | \$47 | \$188 |
| 4 | Duplexes | HH873503 | \$47 | \$188 |
| 4 | Duplexes | HH873504 | \$47 | \$188 |
| 2 | Gravitation™ Power Beam End Cap | HBENDCP | \$70 | \$140 |
| TOTAL: | | | \$4,011 | \$4,011 |

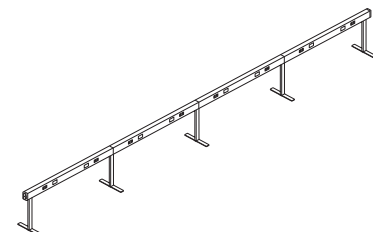

4-PACK — 60"W

| QTY | DESCRIPTION | BUNDLE SKU | LIST PRICE BY PAINT GRADE | | |
|-----|---------------|------------|---------------------------|---------|---------|
| | | | P1 | P2 | P3 |
| 1 | 4-PACK BUNDLE | HBDL460 | \$4,199 | \$4,423 | \$4,535 |

SPECIFYING EXAMPLE: Model.Paint

! Power in-feeds and port covers are not included in Bundles and must be specified separately.



Icon Legend on page 19

GRAVITATION™ 72"W Bundles

WORKSTATIONS

| QTY | DESCRIPTION | MODEL | LIST PRICE | PRICE EXTENSION |
|---------------|---------------------------------|----------|----------------|-----------------|
| 1 | Gravitation™ Power Beam 72"W | HBEAM72 | \$490 | \$490 |
| 2 | Gravitation™ Legs 23"H | HBLEG23 | \$133 | \$266 |
| 1 | End of Run Power Harness | HMPEEK72 | \$249 | \$249 |
| 4 | Duplexes | HH873501 | \$47 | \$188 |
| 2 | Gravitation™ Power Beam End Cap | HBENDCP | \$70 | \$140 |
| TOTAL: | | | \$1,333 | |

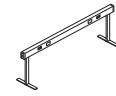

1-PACK – 72"W

| QTY | DESCRIPTION | BUNDLE SKU | LIST PRICE BY PAINT GRADE | | |
|-----|---------------|------------|---------------------------|---------|---------|
| | | | P1 | P2 | P3 |
| 1 | 1-PACK BUNDLE | HBDL172 | \$1,333 | \$1,414 | \$1,454 |

SPECIFYING EXAMPLE: Model.Paint

| QTY | DESCRIPTION | MODEL | LIST PRICE | PRICE EXTENSION |
|---------------|---------------------------------|----------|----------------|-----------------|
| 2 | Gravitation™ Power Beam 72"W | HBEAM72 | \$490 | \$980 |
| 3 | Gravitation™ Legs 23"H | HBLEG23 | \$133 | \$399 |
| 1 | End of Run Power Harness | HMPEEK72 | \$249 | \$249 |
| 1 | Power Harness | HH871272 | \$239 | \$239 |
| 4 | Duplexes | HH873501 | \$47 | \$188 |
| 4 | Duplexes | HH873502 | \$47 | \$188 |
| 2 | Gravitation™ Power Beam End Cap | HBENDCP | \$70 | \$140 |
| TOTAL: | | | \$2,383 | |

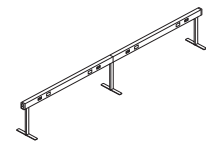

2-PACK – 72"W

| QTY | DESCRIPTION | BUNDLE SKU | LIST PRICE BY PAINT GRADE | | |
|-----|---------------|------------|---------------------------|---------|---------|
| | | | P1 | P2 | P3 |
| 1 | 2-PACK BUNDLE | HBDL272 | \$2,383 | \$2,521 | \$2,589 |

SPECIFYING EXAMPLE: Model.Paint

| QTY | DESCRIPTION | MODEL | LIST PRICE | PRICE EXTENSION |
|---------------|---------------------------------|----------|----------------|-----------------|
| 3 | Gravitation™ Power Beam 72"W | HBEAM72 | \$490 | \$1,470 |
| 4 | Gravitation™ Legs 23"H | HBLEG23 | \$133 | \$532 |
| 1 | End of Run Power Harness | HMPEEK72 | \$249 | \$249 |
| 2 | Power Harness | HH871272 | \$239 | \$478 |
| 4 | Duplexes | HH873501 | \$47 | \$188 |
| 4 | Duplexes | HH873502 | \$47 | \$188 |
| 4 | Duplexes | HH873503 | \$47 | \$188 |
| 2 | Gravitation™ Power Beam End Cap | HBENDCP | \$70 | \$140 |
| TOTAL: | | | \$3,433 | |

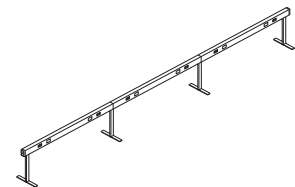

3-PACK – 72"W

| QTY | DESCRIPTION | BUNDLE SKU | LIST PRICE BY PAINT GRADE | | |
|-----|---------------|------------|---------------------------|---------|---------|
| | | | P1 | P2 | P3 |
| 1 | 3-PACK BUNDLE | HBDL372 | \$3,433 | \$3,628 | \$3,724 |

SPECIFYING EXAMPLE: Model.Paint

| QTY | DESCRIPTION | MODEL | LIST PRICE | PRICE EXTENSION |
|---------------|---------------------------------|----------|----------------|-----------------|
| 4 | Gravitation™ Power Beam 72"W | HBEAM72 | \$490 | \$1,960 |
| 5 | Gravitation™ Legs 23"H | HBLEG23 | \$133 | \$665 |
| 1 | End of Run Power Harness | HMPEEK72 | \$249 | \$249 |
| 3 | Power Harness | HH871272 | \$239 | \$717 |
| 4 | Duplexes | HH873502 | \$47 | \$188 |
| 4 | Duplexes | HH873503 | \$47 | \$188 |
| 4 | Duplexes | HH873504 | \$47 | \$188 |
| 2 | Gravitation™ Power Beam End Cap | HBENDCP | \$70 | \$140 |
| TOTAL: | | | \$4,295 | |

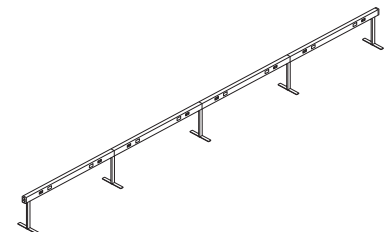

4-PACK – 72"W

| QTY | DESCRIPTION | BUNDLE SKU | LIST PRICE BY PAINT GRADE | | |
|-----|---------------|------------|---------------------------|---------|---------|
| | | | P1 | P2 | P3 |
| 1 | 4-PACK BUNDLE | HBDL472 | \$4,483 | \$4,735 | \$4,859 |

SPECIFYING EXAMPLE: Model.Paint

! Power in-feeds and port covers are not included in Bundles and must be specified separately.



GRAVITATION™ POWER BEAM

WORKSTATIONS

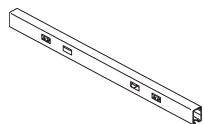

DESCRIPTION

Power Beam

48"W
60"W
72"W

MODEL

HBEAM48
HBEAM60
HBEAM72

SHIP WEIGHT

7
9
11

CUBE

0.6
0.7
0.9

LIST PRICE BY PAINT GRADE

| P1 | P2 | P3 |
|-------|-------|-------|
| \$381 | \$416 | \$433 |
| \$419 | \$457 | \$476 |
| \$490 | \$535 | \$557 |

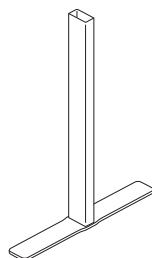

Beam Legs

23"H

HBLEG23

5

0.6

\$133

\$142

\$147

NOTES:

- Beams and legs specified separately.
- Order power harness separately to corresponding beam length.
- Beams ship with mounting brackets for 8-Trac electrical to be installed in the field.
- Beams ship with internal guides to retain power/data wires during installation (internal wire management).
- 2 ports for electrical and 2 ports for data are provided on each side of the rail, total of 8 ports.
- Electrical in-feed can also be accomplished through an electrical knockout (not data) in the face of the rail using a base in-feed.
- Beam height when installed is 23"H. This height aligns with the Empower® height adjustable trough. Gravitation™ and Coordinate™ can be used as single-sided height adjustable benching.
- 2-Pack metal port covers specified separately to cover unused power/data ports.
- Electrical harnesses, duplexes, and power feeds ordered separately.
- Leveling capability of 1/4" internal to rail for clean aesthetic.
- ! With in-line connections between beams, one leg can be shared. Requires one more leg than the number of beams.
- ! Specify paint; not available in Putty (L), Platinum Metallic (T1), and Champagne Metallic (T4).
- ! When two rails share a leg, the leg is centered between the legs in the "outer slot". When the leg is positioned **at the end of a run of rails** (i.e., the rail doesn't connect to another rail), the leg will be inset 1/8" from the end of the rail, not the end cap, in the "inner slot".

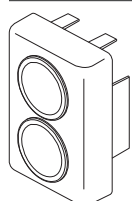

Power Beam End Cap

HBENDCP

1

0.1

\$70

\$76

\$79

NOTES:

- Power can enter into the beam from the floor, wall, or ceiling.
- When using the power pole, please note attachment to beam is up to the installer, as well as field-cutting the power pole to access power and data wires.
- End caps have integral knockout ports with plastic grommets to allow for power/data in-feed (without sharp edges).
- End caps add 1" to the length of the run.



HOW TO SPECIFY

| | |
|--|---|
| <p>Select Model Number</p> <p>H B E A M 6 0 .</p> | <p>Select Paint Color</p> <p>See page 573</p> <p>P R 8</p> |
|--|---|



Icon Legend on page 19

GRAVITATION™ POWER BEAM

| | DESCRIPTION | MODEL | SHIP WEIGHT | CUBE | LIST PRICE BY PAINT GRADE | | |
|--|---|----------------|-------------|------|---------------------------|-------|-------|
| | | | | | P1 | P2 | P3 |
|  HBPRTCV | Knockout Port Covers, Metal | HBPRTCV | 0.5 | 0.1 | \$26 | \$28 | \$29 |
|  HBCONU | Universal Connector ! Used to change direction of beam (L, T, X). Cannot bring in-feed into Universal Connector; use Power Hubs in these instances (HBXXX23). | HBCONU | 2.0 | 0.1 | \$199 | \$213 | \$220 |

NOTES:

- Universal Connector is used to change beam direction when power is not coming in at that location. Power Hub will be used to bring in power at a change of connection.
- Port Covers used to cover open power or data ports if not in use, as desired.
- Able to connect rails in T-, X-, or L-configurations.

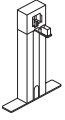
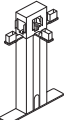
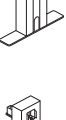
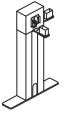
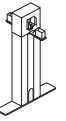
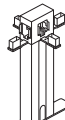
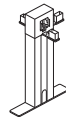
| | DESCRIPTION | MODEL | SHIP WEIGHT | CUBE | LIST PRICE BY PAINT GRADE | | |
|---|---|-----------------|-------------|------|---------------------------|-------|-------|
| | | | | | P1 | P2 | P3 |
|  | Power Hub End of Run Power Hub | HBEORH23 | 10 | 4.0 | \$260 | \$284 | \$295 |
|  | End of Run Power Hub, T | HBEORT23 | 14 | 4.0 | \$287 | \$313 | \$326 |
|  | End of Run Power Hub, L | HBEORL23 | 13 | 4.0 | \$254 | \$277 | \$289 |
|  | In-Line Power Hub | HBILNH23 | 13 | 4.0 | \$274 | \$299 | \$311 |
|  | In-Line Power Hub, X | HBILNX23 | 15 | 4.0 | \$290 | \$316 | \$329 |
|  | In-Line Power Hub, T | HBILNT23 | 14 | 4.0 | \$277 | \$302 | \$315 |
|  | ! Power Hub is used when electrical needs to enter at a connection. For change of direction only (not bringing in power) use Universal Connector. | | | | | | |

NOTES:

- Hub connectors allow power to enter the beam by bringing it through the bottom of the hub or knocking out the mouse hole in the hub.
- Specify correct hub based on desired location of power entering the beam.
- ! Power Hub is used when electrical needs to enter at a connection. For change of direction only (not bringing in power) use Universal Connector (HBCONU).
- ! Hubs are dual use — change of direction “connector” (when choosing L, T, or X hubs) and to bring power to the beam; choose Universal Connector if change of direction is needed **without** bringing power to the beam (HBCONU).
- ! Power can enter the beam in six different ways.
 1. Bring in-feed from floor or wall into end of beam with no cover (see local electrical codes to ensure the use of this solution) — metal flexible (HH871912) or Sealtight (HMP144) conduit available based on code compliance.
 2. HH870070 freestanding Power Pole at end of run.
 3. Vertebrae Wire Manager (HBVWM) from end of beam.
 4. 96” Power Pole (HB96PP) with beam Power Pole Connectors (HBPP*K).
 5. Power Hubs (HBXXX23, see above).
 6. Power Hubs (HBXXX23, see above) with 96” Power Pole (HB96PP) with Hub Connectors (HBPPCK).

HOW TO SPECIFY

| | |
|--|---|
| <p>Select Model Number</p> <p>H B C O N U .</p> | <p>Select Paint Color</p> <p>See page 573</p> <p>P R 8</p> |
|--|---|

GRAVITATION™ POWER BEAM

WORKSTATIONS



SIN 33721

| DESCRIPTION | MODEL | SHIP WEIGHT | CUBE | LIST PRICE |
|--|-----------------|-------------|------|--------------|
| Power Pole — w/o Receptacles 10'5" NOTES: For ceiling in-feed, utilize a freestanding Power Pole placed adjacent to the Power Beam. Power Pole runs to the floor. Specify paint. ⓘ Must be field cut. ⓘ Does not ship with attachment hardware, it is up to the installer to attach Power Pole to the beam. | HH870070 | 14 | 0.5 | \$477 |



| DESCRIPTION | MODEL | SHIP WEIGHT | CUBE | LIST PRICE BY PAINT GRADE | | |
|---|---------------|-------------|------|---------------------------|--------------|--------------|
| | | | | P1 | P2 | P3 |
| Power Pole 96" NOTES: Power Pole connects to hub or with Mid or End Cap connectors. Power Pole terminates at beam or hub height (does not run to the floor). | HB96PP | 5.0 | 0.9 | \$731 | \$797 | \$830 |

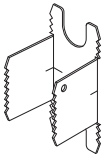

| | | | | | | |
|--|---------------|--------|-----|-------------|------------|------------|
| Power Pole Splice Kit NOTES: Use Splice Kit to join two Power Poles when one pole does not meet the required ceiling height. | HBPPSK | 0.25 ⓘ | 0.1 | \$56 | N/A | N/A |
|--|---------------|--------|-----|-------------|------------|------------|

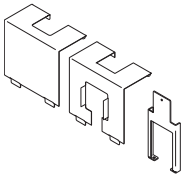

| | | | | | | |
|--|---------------|-------|-----|-------------|-------------|-------------|
| Power Pole Power Hub Connector NOTES: Specify when bringing Power Pole into Power Hub. | HBPPCK | 1.0 ⓘ | 0.1 | \$56 | \$61 | \$64 |
|--|---------------|-------|-----|-------------|-------------|-------------|

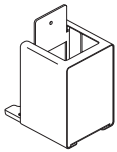

| | | | | | | |
|--|---------------|-------|-----|-------------|-------------|-------------|
| Power Pole End Cap Connector NOTES: Specify when bringing Power Pole into the end of a beam. | HBPPEK | 1.5 ⓘ | 0.1 | \$56 | \$61 | \$64 |
|--|---------------|-------|-----|-------------|-------------|-------------|

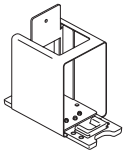

| | | | | | | |
|--|---------------|-------|-----|-------------|-------------|-------------|
| Power Pole Mid Connector NOTES: Specify when bringing Power Pole into junction of two beams. | HBPPMK | 1.5 ⓘ | 0.1 | \$56 | \$61 | \$64 |
|--|---------------|-------|-----|-------------|-------------|-------------|



| | | | | | | |
|---|--------------|-------|-----|--------------|--------------|--------------|
| Vertebrae Wire Manager NOTES: Connects to end of beam — Vertebrae conceals cords entering the beam. | HBVWM | 1.8 ⓘ | 0.2 | \$302 | \$329 | \$343 |
|---|--------------|-------|-----|--------------|--------------|--------------|



| | | | | | | |
|--|--------------|-------|-----|-------------|-------------|-------------|
| Floor Anchor Bracket NOTES: Used to connect beam to the floor in situations where the beam needs to be tethered to the ground so users cannot move it. | HBFAB | 0.2 ⓘ | 0.1 | \$23 | \$25 | \$26 |
|--|--------------|-------|-----|-------------|-------------|-------------|

HOW TO SPECIFY

| | |
|--------------------------------------|--|
| Select Model Number HB96PP | Select Paint Color See page 573 PR8 |
|--------------------------------------|--|



GRAVITATION™ POWER BEAM Electrical

| DESCRIPTION | MAX. RECEPT. CAP. PER PANEL SIDE | MODEL | | SHIP WEIGHT | CUBE | LIST PRICE |
|---|----------------------------------|--------------------------|----------------------------------|-------------|------|------------|
| | | FOUR-CIRCUIT 3 + 1 2 + 2 | THREE-CIRCUIT, SEPARATE NEUTRALS | | | |
| Electrical Power Harnesses, Frames — w/duplex capacity | | | | | | |
| For 48"W | 2 | HH871248 | HH871248A | 3.0 Ⓢ | 0.5 | \$239 |
| For 60"W | 2 | HH871260 | HH871260A | 3.0 Ⓢ | 0.5 | \$239 |
| For 72"W | 2 | HH871272 | HH871272A | 5.0 Ⓢ | 0.5 | \$239 |
| Abound® Duplex Receptacles | | | | | | |
| Circuit 1 | | HH873501 | HH873501A | 0.5 Ⓢ | 0.1 | \$47 |
| Circuit 2 | | HH873502 | HH873502A | 0.5 Ⓢ | 0.1 | \$47 |
| Circuit 3 | | HH873503 | HH873503A | 0.5 Ⓢ | 0.1 | \$47 |
| Circuit 4 | | HH873504 | | 0.5 Ⓢ | 0.1 | \$47 |
| Circuit 1 — 20 amp outlet | | HH871601 | HH871601A | 1.0 Ⓢ | 0.1 | \$47 |
| Circuit 3 (2 + 2) | | HH873506 | | 0.5 Ⓢ | 0.1 | \$47 |
| Specify color. | | | | | | |
| Ceiling In-Feed | | | | | | |
| 144" long conduit, Flex Cable — 7/8" dia. | | HH871912 | HH871912A | 4.0 Ⓢ | 0.5 | \$263 |
| 216" long conduit, Flex Cable — 7/8" dia. | | HH871918 | HH871918A | 4.0 Ⓢ | 0.5 | \$342 |
| ⚠ Must be used with Power Pole. Power in-feed models HH871912 and HH871918 plug into the end of any power block. No portion of the cable can be exposed after installation. | | | | | | |
| Power In-Feed — Sealtight | | | | | | |
| 144" long conduit, Sealtight Cable — 7/8" diameter | | HMP144 | | 7 | 1.2 | \$367 |
| NOTES: For use as ceiling, floor and wall in-feed. If three-circuit, separate neutral in-feed is required, please contact Tailored Solutions. | | | | | | |
| ⚠ Bend radius of Sealtight in-feed is limited — use in straight entrance applications. | | | | | | |
| AMP Data Faceplates | | | | | | |
| Three-port flex-mode faceplate | | HHTADF3 | | 1 Ⓢ | 0.2 | \$29 |
| Four-port flex-mode faceplate | | HHTADF4 | | 1 Ⓢ | 0.2 | \$29 |
| ⚠ Data faceplates available in Black (E4) only. | | | | | | |
| AMP RJ45 CAT 5E Jack — Black (P) | | HHTADJ5 | | 1 Ⓢ | 0.1 | \$46 |
| AMP RJ45 CAT 6 Jack — Black (P) | | HHTADJ6 | | 1 Ⓢ | 0.1 | \$62 |
| Models HHTADJ5 and HHTADJ6 snap into faceplate. | | | | | | |
| NOTES: AMP Data Faceplates attach to bottom of panel or at worksurface height in front of baserail covers for easy cable routing. Faceplates cannot be installed back-to-back in a panel application. | | | | | | |
| End of Run Electrical Kit | | | | | | |
| 48"W | | HMPEEK48 | | 3 | 0.5 | \$249 |
| 60"W | | HMPEEK60 | | 3 | 0.5 | \$249 |
| 72"W | | HMPEEK72 | | 5 | 0.5 | \$249 |

HOW TO SPECIFY

Select Model Number

HH871248

GRAVITATION™ POWER BEAM Screens

OPEN MARKET

WORKSTATIONS

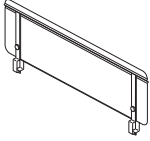

DESCRIPTION

Graviton™ Metal Screen
48"W x 18¾"H
60"W x 18¾"H
72"W x 18¾"H

MODEL

HBSCRAOMTL48
HBSCRAOMTL60
HBSCRAOMTL72

SHIP WEIGHT

10.3
12.0
15.7

CUBE

3.1
3.7
4.4

LIST PRICE BY PAINT GRADE

| P1 | P2 | P3 |
|-------|-------|-------|
| \$375 | \$409 | \$426 |
| \$452 | \$493 | \$514 |
| \$485 | \$529 | \$551 |

NOTES:

- A screen can be mounted above the beam to add privacy.
- Screens ship with mounting hardware.
- Screens are wipeable.
- Screens are magnetic.
- Also available in Markerboard paint.

HOW TO SPECIFY

Select Model Number

H B S C R A O M T L 6 0 .

Select Paint Color

See page 573

P 7 1

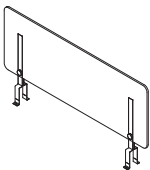

DESCRIPTION

Graviton™ Beam PET Screen
48"W x 20"H
60"W x 20"H
72"W x 20"H

MODEL

HUVDSBS2048
HUVDSBS2060
HUVDSBS2072

SHIP WEIGHT

3.5 Ⓞ
4.4 Ⓞ
5.3 Ⓞ

CUBE

4.1
5.0
5.9

LIST PRICE BY PAINT GRADE

| P1 | P2 | P3 |
|-------|-------|-------|
| \$621 | \$625 | \$641 |
| \$679 | \$683 | \$699 |
| \$842 | \$846 | \$862 |

HOW TO SPECIFY

Select Model Number

H U V D S B 2 0 6 0 .

Select PET Color

DDB1 Dark Blue
DGN1 Green
DGY4 Dark Gray
DGY3 Medium Gray

D G N 1 .

Select Paint Color

See page 573

P R 6

SYSTEMS SHARED COMPONENTS

Want to see more?
Scan here to check
out hon.com.



WORKSTATIONS

Systems Worksurfaces, Accelerate® Panels, Systems Overhead Storage, Voi® O-Legs and Storage shown with Lota® Task Chairs.

SYSTEMS SHARED COMPONENTS

Panel-based workstations make efficient use of space, giving your people a place of their own that's still part of the action. Modular components are easy to specify and install, so you can configure them just about any which way — and reconfigure fast when your needs change. Systems models integrate seamlessly with Abode, Abound, Accelerate, Empower and Voi models and can be configured to create freestanding or height adjustable workstations.

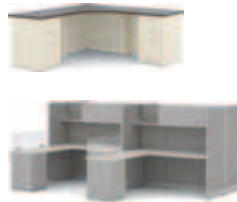

FEATURES

- Systems worksurfaces and supports can be used with Abode, Abound, Accelerate, Coordinate, Empower and Voi products.
- Systems electrical and data components can be used with Abode, Abound, Accelerate and Empower products.
- Systems storage can be used with Abound and Accelerate products.

SYSTEMS OVERHEAD AND SHELVES SPECIFYING

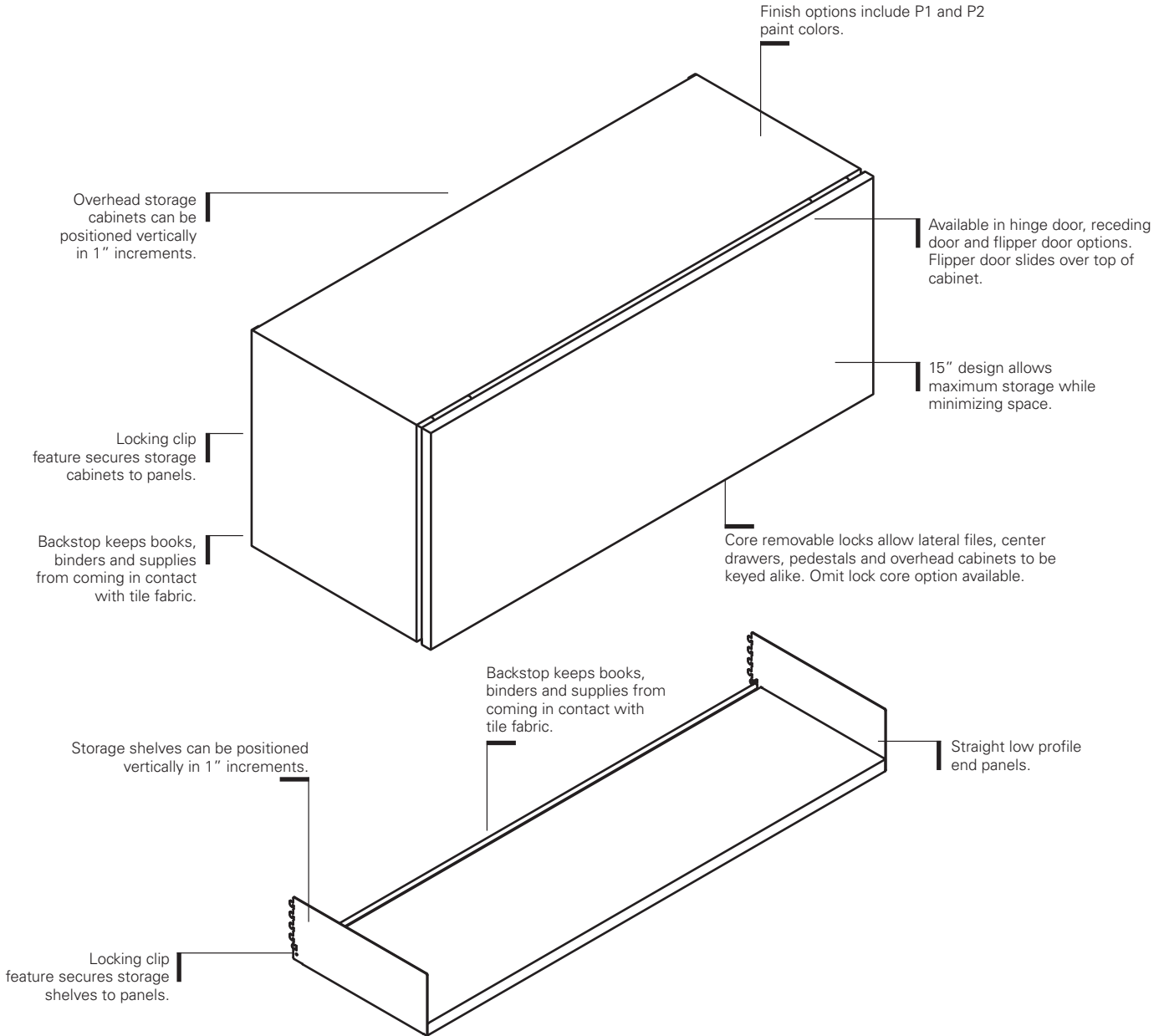

PRODUCT DIMENSIONS

Overhead Storage Cabinet

Width 24", 30", 36", 42", 48", 60"

Inside width Flipper and Receding door — $\frac{3}{8}$ " less than width
Hinged door — $1\frac{3}{4}$ " less than width

Depth $14\frac{7}{8}$ "

Inside depth $12\frac{7}{8}$ "

Height 15"

Inside height $12\frac{3}{4}$ "

Open Shelf

Width 24", 30", 36", 42", 48", 60"

Depth $14\frac{3}{8}$ "

Height $5\frac{5}{8}$ "

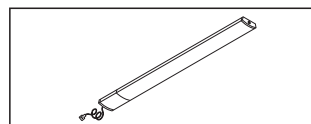

Task lights can be mounted beneath storage shelves and overhead storage cabinets.

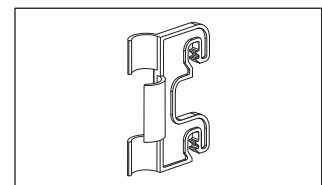

Cord retainer clips fasten into panel slots to anchor power cords. Available in black only. Clips are provided with undershelf mounted task lights.

SYSTEMS OVERHEAD AND SHELVES SPECIFYING

SPECIFICATION GUIDELINES

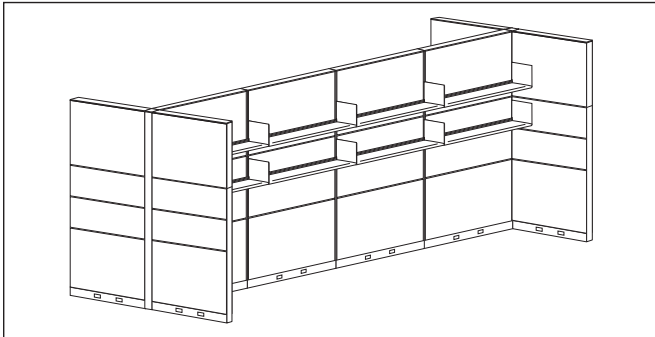

In a panel run, only two overhead storage cabinets or open storage shelves are recommended per panel side. When suspending overhead storage off-module only one storage unit per panel side is allowed.

When overhead storage units are suspended from stacking frames, the following guidelines should be adhered to:

A maximum of two overhead storage units can be suspended from each side of stacking frames on any given panel.

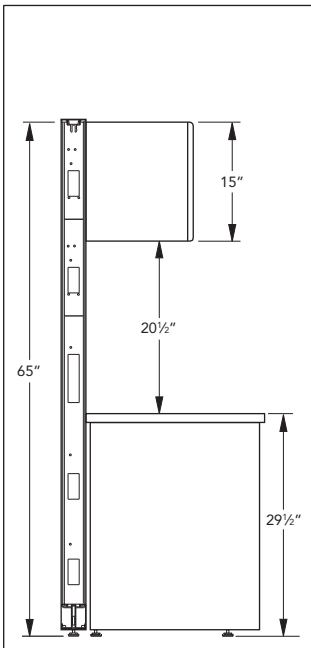

Overhead Storage cabinets and the **Open Shelf** can also be mounted to a maximum height of 65"H on all systems. Voi overheads not to be mounted on Accelerate stackers.

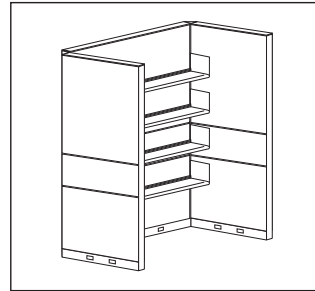

No limitation to the number of units on structural frames when units are spaced 12" apart and when the run is supported with return panels of equal height to the spine wall on each side of storage shelves or overhead storage cabinets.

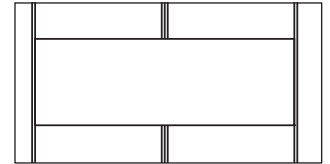

Storage shelf and overhead width must correspond with width of panel(s). It is possible to span two panels when combined panel width equals cabinet or shelf width.

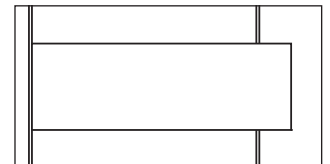

Overhead Cabinets can be mounted on a panel equal to or up to 18" narrower than cabinet.

Not applicable for ETA overheads, Voi overheads, and shelves.

SYSTEMS

Overhead and Shelves

GSA SIN 33721



Icon Legend on page 19

WORKSTATIONS

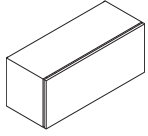

DESCRIPTION

Metal Flipper Door Overheads

24"W x 14³/₈"D x 15"H
 30"W x 14³/₈"D x 15"H
 36"W x 14³/₈"D x 15"H
 42"W x 14³/₈"D x 15"H
 48"W x 14³/₈"D x 15"H
 60"W x 14³/₈"D x 15"H
 72"W x 14³/₈"D x 15"H

MODEL

SHIP WEIGHT

CUBE

LIST PRICE BY PAINT GRADE

P1

P2

| | | | | |
|------------------|----|------|---------------|---------------|
| HRVOH24FM | 35 | 3.6 | \$597 | \$646 |
| HRVOH30FM | 38 | 4.4 | \$607 | \$656 |
| HRVOH36FM | 41 | 5.3 | \$635 | \$684 |
| HRVOH42FM | 46 | 6.1 | \$666 | \$715 |
| HRVOH48FM | 52 | 6.9 | \$697 | \$746 |
| HRVOH60FM | 62 | 8.6 | \$917 | \$966 |
| HRVOH72FM | 82 | 10.6 | \$1052 | \$1101 |

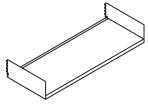

Open Shelf

24"W x 14³/₈"D x 5⁵/₈"H
 30"W x 14³/₈"D x 5⁵/₈"H
 36"W x 14³/₈"D x 5⁵/₈"H
 42"W x 14³/₈"D x 5⁵/₈"H
 48"W x 14³/₈"D x 5⁵/₈"H
 60"W x 14³/₈"D x 5⁵/₈"H
 72"W x 14³/₈"D x 5⁵/₈"H

| | | | | |
|----------------|-------------|-----|--------------|--------------|
| HRVSH24 | 13 Ⓞ | 1.2 | \$257 | \$274 |
| HRVSH30 | 15 Ⓞ | 1.5 | \$279 | \$296 |
| HRVSH36 | 16 Ⓞ | 1.8 | \$297 | \$314 |
| HRVSH42 | 17 Ⓞ | 1.9 | \$308 | \$325 |
| HRVSH48 | 18 Ⓞ | 2.3 | \$322 | \$339 |
| HRVSH60 | 20 | 2.9 | \$394 | \$411 |
| HRVSH72 | 32 | 3.6 | \$514 | \$531 |

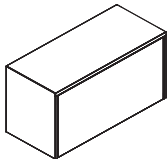

Receding Door Overhead

30"W x 13³/₈"D x 15"H
 36"W x 13³/₈"D x 15"H
 42"W x 13³/₈"D x 15"H
 48"W x 13³/₈"D x 15"H
 60"W x 13³/₈"D x 15"H

| | | | | |
|--------------------|----|------|---------------|---------------|
| HRVOH1530RM | 38 | 5.7 | \$770 | \$823 |
| HRVOH1536RM | 41 | 6.8 | \$812 | \$865 |
| HRVOH1542RM | 46 | 7.8 | \$863 | \$916 |
| HRVOH1548RM | 52 | 8.9 | \$935 | \$988 |
| HRVOH1560RM | 62 | 11.2 | \$1417 | \$1470 |

NOTES:

- Overhead Storage Cabinets with doors are standard with a factory installed core removable lock located on the underside of the cabinet.
- All units feature an anti-dislodgement device.
- 60" and 72"W units are one piece cabinet with two doors.
- Upmount kits can be used with all metal overheads.

! Keyed alike cores must be ordered separately — see page 773.

HOW TO SPECIFY

Select Model Number

HRVOH24FM

Select Paint Color

See page 481

T4

Select Lock Option











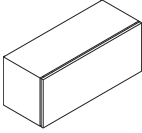





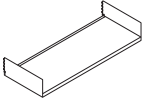

L Lock
 X Omit Lock (deduct \$20) (where applicable)
 See page 773

L





SYSTEMS

ETA Overheads and Shelves

| | DESCRIPTION | MODEL | SHIP WEIGHT | CUBE | LIST PRICE BY PAINT GRADE | |
|---|-------------------------------|--|--|------|---------------------------|--------------|
| | | | | | P1 | P2 |
|  | Flipper Door Overheads | | | | | |
| | 24"W x 13"D x 15"H | HEOHRTA1524FD | 21 | 1.6 | \$479 | \$528 |
| | 30"W x 13"D x 15"H | HEOHRTA1530FD  | 24 | 1.6 | \$486 | \$535 |
| | 36"W x 13"D x 15"H | HEOHRTA1536FD  | 27 | 1.6 | \$510 | \$559 |
| | 42"W x 13"D x 15"H | HEOHRTA1542FD | 30 | 1.8 | \$536 | \$585 |
| | 48"W x 13"D x 15"H | HEOHRTA1548FD  | 33 | 2.1 | \$557 | \$606 |
| | 60"W x 13"D x 15"H | HEOHRTA1560FD  | 42 | 2.5 | \$735 | \$784 |
| | 72"W x 13"D x 15"H | HEOHRTA1572FD  | 49 | 3.0 | \$913 | \$962 |
|  | Open Shelves | | | | | |
| | 24"W x 13"D x 5 5/8"H | HESHRTA24 | 10  | 1.9 | \$224 | \$241 |
| | 30"W x 13"D x 5 5/8"H | HESHRTA30  | 11  | 1.9 | \$242 | \$259 |
| | 36"W x 13"D x 5 5/8"H | HESHRTA36  | 12  | 1.9 | \$257 | \$274 |
| | 42"W x 13"D x 5 5/8"H | HESHRTA42 | 13  | 2.1 | \$265 | \$282 |
| | 48"W x 13"D x 5 5/8"H | HESHRTA48  | 14  | 2.4 | \$280 | \$297 |
| | 60"W x 13"D x 5 5/8"H | HESHRTA60  | 16  | 3.0 | \$341 | \$358 |
| | 72"W x 13"D x 5 5/8"H | HESHRTA72 | 18  | 3.5 | \$402 | \$419 |

NOTES:

- Storage Cabinets with doors are standard with a factory installed core removable lock located on the underside of the cabinet.
 - All units feature an anti-dislodgement device.
 - Accepts under cabinet lighting.
 - ETA overheads and shelves ship flat packed.
 - Only one installer is needed to assemble an ETA overhead on a panel (all sizes).
 - Attachment brackets are attached to the back of the unit (included).
 - ETA overheads and shelves are slightly less deep than built-up models. Please note when using next to built-up models.
 - Order overhead and shelf to match the width of panel being used.
-  Keyed alike cores must be ordered separately — see page 773.
-  Cannot be used in off-modular applications because attachment bracket is attached to the back of the case and cannot be moved.

HOW TO SPECIFY

| | |
|--|--|
| Select Model Number | Select Paint Color See page 481 |
| <div style="display: flex; justify-content: space-around; border: 1px solid black; padding: 2px;"> HEOHRTA1524FD </div> | <div style="display: flex; justify-content: space-around; border: 1px solid black; padding: 2px;"> T1 </div> |

SYSTEMS

Overhead Storage

GSA SIN 33721



Icon Legend on page 19

WORKSTATIONS

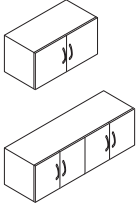

DESCRIPTION

Steel Front Hinged Door Overhead with Arch Pull

24"W x 15"D x 15"H
30"W x 15"D x 15"H
36"W x 15"D x 15"H
42"W x 15"D x 15"H
48"W x 15"D x 15"H

MODEL

HRVOHV24HMA
HRVOHV30HMA
HRVOHV36HMA
HRVOHV42HMA
HRVOHV48HMA

SHIP WEIGHT

32
36
42
52
56

CUBE

5.6
6.8
7.7
8.1
9.2

LIST PRICE BY PAINT GRADE

P1 **P2**

\$805 **\$854**
\$833 **\$882**
\$862 **\$911**
\$892 **\$941**
\$924 **\$973**

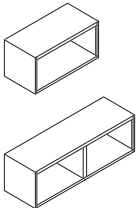

Open Storage Cabinet

24"W x 15"D x 15"H
30"W x 15"D x 15"H
36"W x 15"D x 15"H
42"W x 15"D x 15"H
48"W x 15"D x 15"H

HRVSHV24
HRVSHV30
HRVSHV36
HRVSHV42
HRVSHV48

21
26
29
32
37

5.6
6.8
7.7
8.1
9.2

\$734 **\$783**
\$758 **\$807**
\$790 **\$839**
\$819 **\$868**
\$850 **\$899**

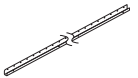

Abound®/Accelerate® Horizontal Wall Track for Overhead Storage

60"W

HTWTH

5

0.8

\$95

N/A

NOTES: Use when mounting overhead storage and when a permanent wall hanger kit is not desired. For 72"W overheads, use two wall tracks cut to 36".

⚠ Cannot be used with ETA storage or Voi®. Can only be used with systems flipper door, receding door and hinged door overheads.

NOTES:

- Overhead Storage Cabinets with doors are standard with a factory installed core removable lock located on the underside of the cabinet.
- Upmount kits can be used with all metal overheads.

⚠ Keyed alike cores must be ordered separately — see page 773.

HOW TO SPECIFY

Select Model Number

Select the Pull

A Satin Chrome Arch

H R V O H V 2 4 H M A .

Select Lock Option

L Lock
X Omit Lock (deduct \$20) (where applicable)
See page 773

L .

Select Paint Color

See page 481

T 4



Icon Legend on page 19

Laminate Front Overhead Storage

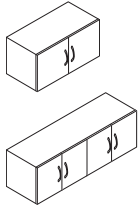

| DESCRIPTION | MODEL | SHIP WEIGHT | CUBE | LIST PRICE BY PAINT GRADE | |
|--|--------------------|-------------|------|---------------------------|---------------|
| | | | | P1 | P2 |
| Laminate Front Hinged Door Overheads with Arch Pull | | | | | |
| 24"W x 15"D x 15"H | HRVOHV24HLA | 35 | 5.6 | \$989 | \$1038 |
| 30"W x 15"D x 15"H | HRVOHV30HLA | 40 | 6.8 | \$1020 | \$1069 |
| 36"W x 15"D x 15"H | HRVOHV36HLA | 48 | 7.7 | \$1049 | \$1098 |
| 42"W x 15"D x 15"H | HRVOHV42HLA | 53 | 8.1 | \$1079 | \$1128 |
| 48"W x 15"D x 15"H | HRVOHV48HLA | 64 | 9.2 | \$1105 | \$1154 |

NOTES:

- Unit features metal chassis and laminate doors.
- Laminate fronts are available in L1 woodgrain only.
- Overhead Storage Cabinets with doors are standard with a factory installed core removable lock located on the underside of the cabinet.
- Upmount kits can be used with all metal overheads.

! Keyed alike cores must be ordered separately — see page 773.

HOW TO SPECIFY

| | | | |
|---|---|---|---|
| <p>Select Model Number</p> <p>Select the Pull</p> <p>A Satin Chrome Arch</p> <p>H R V O H V 2 4 H L A .</p> | <p>Select Lock Option</p> <p>L Lock X Omit Lock (deduct \$20) See page 773</p> <p>L .</p> | <p>Select Front Laminate Color</p> <p>L1 Woodgrain only See page 481</p> <p>H .</p> | <p>Select Case Paint Color</p> <p>See page 481</p> <p>T 4</p> |
|---|---|---|---|

VOI® Overhead Storage

GSA SIN 33721



Icon Legend on page 19

WORKSTATIONS

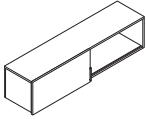

DESCRIPTION

Overhead Cabinet with One Sliding Door

36"W x 14¼"D x 14"H
42"W x 14¼"D x 14"H
48"W x 14¼"D x 14"H
60"W x 14¼"D x 14"H
66"W x 14¼"D x 14"H
72"W x 14¼"D x 14"H

| MODEL | SHIP WEIGHT | CUBE | L1 LIST | L2 UPCHARGES | |
|------------------|-------------|------|---------------|--------------|-------------|
| | | | | CABINET | DOOR |
| HLSL1436S | 39 | 9.7 | \$1120 | \$25 | \$20 |
| HLSL1442S | 48 | 9.7 | \$1174 | \$25 | \$20 |
| HLSL1448S | 57 | 12.1 | \$1208 | \$25 | \$20 |
| HLSL1460S | 69 | 13.3 | \$1301 | \$30 | \$25 |
| HLSL1466S | 83 | 14.6 | \$1436 | \$30 | \$25 |
| HLSL1472S | 95 | 15.9 | \$1567 | \$35 | \$25 |

NOTES: Only available in laminate.

! Overhead and Stack-on storage units do not lock.

NOTES:

- Voi® Overhead Storage can be used with Accelerate® and Abound® panels.
- All Overhead Cabinets shown above and on next page can be used as a wall mount, panel mount or stack-on storage with O-leg.
- Can be mounted on O-legs, panel brackets or wall mount brackets. See page 592.
- Tackboards are available for wall mount storage applications.
- Sliding door overhead does not ship with a pull — door overhangs chassis to slide.
- Overhead cabinets with four doors are available in laminate or mixed materials.
- For all color specifying combinations, see matrix on page 183.
- Storage cases accept binder height items.
- Storage cube fits inside stack-on storage or overhead cabinet units to provide paper management.
- Wall mount brackets specified with unit. Brackets attach to case horizontally.
- For panel mounted applications, brackets and hardware are ordered separately, see page 630. Brackets attach to panel and case is screwed into brackets. Two brackets needed for 60" unit; three brackets needed for 66" and larger.
- If Wall Bracket option is selected, \$150 upcharge applies.
- For additional information see the Workplace Tools section in the 2021 Shared Spaces Pricer.

! Stack-on Storage must be placed over two full-height supports. Cannot be placed over non-supported sections such as returns using a flat bracket or tower-to-worksurface bracket.

HOW TO SPECIFY

| | | | | |
|--|--|---|---------------------------------|--|
| Select Model Number For locking overhead models, add an "L" suffix (\$40 upcharge per model) | Select Cabinet Laminate See page 183 | Select Door Laminate See page 183 | Select Pull X No Pull | Specify Bracket Option X No Bracket W Wall Bracket (\$150 upcharge) |
| H L S L 1 4 7 2 S . | N . | N . | X . | W |



VOI® Overhead Storage

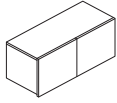

DESCRIPTION

Overhead Cabinet with Doors

- 36"W x 14¼"D x 14"H, 2 doors
- 42"W x 14¼"D x 14"H, 2 doors
- 48"W x 14¼"D x 14"H, 3 doors
- 60"W x 14¼"D x 14"H, 4 doors

| MODEL | SHIP WEIGHT | CUBE | L1 LIST | L2 UPCHARGES | |
|------------------|-------------|------|---------------|--------------|-------------|
| | | | | CABINET | DOOR |
| HLSL1436D | 39 | 9.7 | \$945 | \$25 | \$20 |
| HLSL1442D | 48 | 9.7 | \$1051 | \$25 | \$20 |
| HLSL1448D | 57 | 12.1 | \$1166 | \$25 | \$30 |
| HLSL1460D | 115 | 13.3 | \$1301 | \$30 | N/A |

❗ 2-Door and 3-Door Overhead Cabinet with Doors models HLSL1436D – HLSL1448D available in laminate only. The 60" model HLSL1460D is available in all door finish options.

❗ Overhead and Stack-on storage units do not lock.

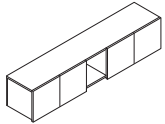

Overhead Cabinet with 4 Doors/Cubbies

- 66"W x 14¼"D x 14"H with 6" Cubbie
- 72"W x 14¼"D x 14"H with 12" Cubbie

| | | | | | |
|------------------|-----|------|---------------|-------------|-------------|
| HLSL1466D | 126 | 14.6 | \$1436 | \$30 | \$30 |
| HLSL1472D | 139 | 15.9 | \$1567 | \$35 | \$35 |

NOTES: Doors available in laminate or mixed materials.

NOTES:

- Voi® Overhead Storage can be used with Accelerate® and Abound® panels.
- All Overhead Cabinets shown above and on previous page can be used as a wall mount, panel mount or stack-on storage with O-leg.
- Can be mounted on O-legs, panel brackets or wall mount brackets. See page 592.
- Tackboards are available for wall mount storage applications.
- Overhead cabinets with four doors are available in laminate or mixed materials.
- For all color specifying combinations, see matrix on page 183.
- Storage cases accept binder height items.
- Storage cube fits inside stack-on storage or overhead cabinet units to provide paper management.
- Wall mount brackets specified with unit. Brackets attach to case horizontally.
- For panel mounted applications, brackets and hardware are ordered separately, see page 630. Brackets attach to panel and case is screwed into brackets. Two brackets needed for 60" unit.
- If Wall Bracket option is selected, \$150 upcharge applies.
- ❗ Stack-on Storage must be placed over two full-height supports. Cannot be placed over non-supported sections such as returns using a flat bracket or tower-to-worksurface bracket.
- ❗ TIG doors not available with a locking option.

HOW TO SPECIFY

| | | | |
|---|---|--|--|
| <p>Select Model Number</p> <p>For locking overhead models, add an "L" suffix (\$40 upcharge per model)</p> | <p>Select Cabinet Laminate</p> <p>See page 183</p> | <p>Select Door Material</p> <p>Upcharges for door selection:</p> <p>4-Door \$315</p> <p>TIG Platinum Polymer with Frosted Glass</p> <p>Also available in laminate doors. See page 183.</p> <p>Not specified for models HLSL1436D – HLSL1448D. These models are available in laminate only.</p> | <p>Select Bracket Option</p> <p>X No Bracket</p> <p>W Wall Bracket (\$150 upcharge)</p> |
| <p>H L S L 1 4 6 0 D .</p> | <p>N .</p> | <p>T I G .</p> | <p>X</p> |

VOI® Overhead and Stack-on Storage

GSA SIN 33721



Icon Legend on page 19

WORKSTATIONS

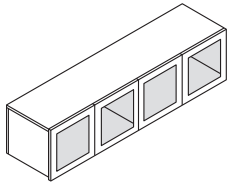

| DESCRIPTION | MODEL | SHIP WEIGHT | CUBE | LIST PRICE BY LAMINATE GRADE | |
|---|------------------|-------------|------|------------------------------|--------|
| | | | | L1 | L2 |
| Overhead Cabinet with 4 Frosted, Metal Frame Doors 60"W x 14¼"D x 14"H ⓘ Must specify an X or W for attachment bracket option below. | HLSL1460M | 115 | 11.4 | \$2141 | \$2171 |

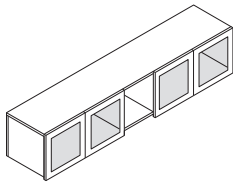

| | | | | |
|--|-----|------|--------|--------|
| Overhead Cabinet with 4 Frosted, Metal Frame Doors 72"W x 14¼"D x 14"H with 12" Cubbie HLSL1472M | 139 | 13.6 | \$2412 | \$2447 |
| 66"W x 14¼"D x 14"H with 6" Cubbie HLSL1466M | 126 | 12.5 | \$2275 | \$2305 |

ⓘ Must specify an X or W for attachment bracket option below.



| | | | | |
|---|---|-----|-------|-----|
| Storage Cube 12"W x 12"D HLSL1212 | 1 | 0.3 | \$316 | N/A |
|---|---|-----|-------|-----|

SPECIFYING EXAMPLE: HLSL1212.P8S

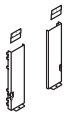

| DESCRIPTION | MODEL | SHIP WEIGHT | CUBE | LIST PRICE BY PAINT GRADE | |
|--|----------------|-------------|------|---------------------------|-------|
| | | | | P1 | P2 |
| Voi® for Systems Stack-on Storage Panel Mounted Bracket Used to panel mount stack-on storage units Specify paint NOTES: Ships with one set of three brackets, which includes one right, one center and one left bracket. When using a 60"W overhead on a 60"W panel or a 72"W overhead on a 72"W panel, only two of the three brackets provided are required. SPECIFYING EXAMPLE: HLSLPMB.T1 | HLSLPMB | 3 ⓘ | 1.0 | \$145 | \$155 |

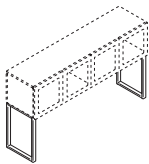

| | | | | |
|---|---|-----|-------|-------|
| O-Leg Support for Overhead Cabinet Ships 2/pack 14⅞"D x 20½"H for 65"H Overhead Cabinet HLSL650S | 8 | 1.1 | \$526 | \$530 |
| 14⅞"D x 5½"H for 50"H Overhead Cabinet HLSL500S | 6 | 1.0 | \$437 | \$441 |

NOTES:

- Voi® Overhead Storage can be used with Accelerate® and Abound® panels.
- Overhead and Stack-on storage units do not lock.
- Use O-Leg Support models for Overhead Cabinets.
- If Wall Bracket option is selected, \$150 upcharge applies.
- Storage cube fits inside stack-on storage or wall mount units to provide paper management.
- Storage Cubes are available in the following colors: Atom (P8S), Bullseye (PJF), Ember (P8P), Ion (P8N), Iris (P8J), Krypton (P8F), and Regatta (P8M).

ⓘ Stack-on Storage must be placed over two full-height supports. Cannot be placed over non-supported sections such as returns using a flat bracket or tower-to-worksurface bracket.

HOW TO SPECIFY

| | | | |
|---|---|--|---|
| Select Model Number HLSL1460M | Select Cabinet Laminate See page 183 N | Select Door Material TIG Platinum Metal Doors with Frosted Glass (no upcharge) | Select Bracket Option X No Bracket W Wall Bracket (\$150 upcharge) |
|---|---|--|---|



Shared Overhead Storage Components

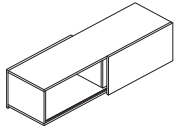

DESCRIPTION

Shared Overhead Storage — Left
 60"W x 17"D x 14"H
 72"W x 17"D x 14"H

MODEL

HLSL1760SOL
HLSL1772SOL

SHIP WEIGHT

115
 139

CUBE

14.8
 17.0

L1 LIST

\$1429
\$1723

L2 UPCHARGES
CABINET DOOR

\$20 \$40
\$25 \$40

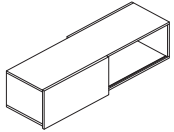

Shared Overhead Storage — Right
 60"W x 17"D x 14"H
 72"W x 17"D x 14"H

HLSL1760SOR
HLSL1772SOR

115
 139

14.8
 17.0

\$1429
\$1723

\$20 \$40
\$25 \$40



DESCRIPTION

Post Legs for Shared Storage
 14"H Post Legs
 22"H Post Legs

MODEL

HLSL140SPL
HLSL220SPL

SHIP WEIGHT

10
 13

CUBE

1.1
 3.7

LIST PRICE BY PAINT GRADE
P1 P2

\$381 \$385
\$422 \$426

NOTES: 14"H post legs on worksurfaces will span 35"H panel or shorter. 14"H post legs on low credenzas will span 30"H panel or shorter. 22"H post legs on worksurfaces will span 50"H panel or shorter. 22"H post legs on low credenzas will span 35"H panel or shorter. Specify paint.

SPECIFYING EXAMPLE: HLSL140SPL.T4



Panel Mount Bracket for Shared Overhead

Panel Mount Bracket for Overhead Storage — Accelerate®
 Panel Mount Bracket for Overhead Storage — Abound®
 Panel Mount Bracket for Overhead Storage — Accelerate®/Abound® 42½"H panels only

HLSLPMBSOA
HLSLPMBSOB
HLSLPMBSO42

4
 4
 4

0.1
 0.1
 0.1

\$150 \$154
\$150 \$154
\$140 \$144

NOTES: Specify paint.

SPECIFYING EXAMPLE: HLSLPMBSOA.T4

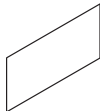

Markerboard for Shared Storage

30"W x 15"D for use with 60"W Shared Overhead
 36"W x 15"D for use with 72"W Shared Overhead

HLSL1530SOMB
HLSL1536SOMB

6
 8

1.0
 1.0

\$143
\$192

NOTES: No specification necessary.

HOW TO SPECIFY

| | | | |
|--|--|---|--|
| <p>Select Model Number</p> <p>HLSL1760SOL .</p> | <p>Select Chassis Laminate</p> <p>See page 183</p> <p>N .</p> | <p>Select Door Front Laminate</p> <p>See page 183</p> <p>N .</p> | <p>Select Pull Color</p> <p>T4 Champagne Metallic T1 Platinum Metallic WHIT White</p> <p>T4</p> |
|--|--|---|--|

| | |
|---|--|
| <p>Select Model Number</p> <p>HLSL140SPL .</p> <p>HLSLPMBSOA .</p> | <p>Select Paint Color</p> <p>See page 183</p> <p>T4</p> <p>T4</p> |
|---|--|

SYSTEMS

Overhead and Shelves

GSA SIN 33721



Icon Legend on page 19

WORKSTATIONS

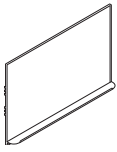

DESCRIPTION

Markerboards
 36"W x 24"H
 42"W x 24"H
 48"W x 24"H

MODEL

HHMRK36
HHMRK42
HHMRK48

SHIP WEIGHT

15 Ⓞ
 17 Ⓞ
 19 Ⓞ

CUBE

3.2
 4.0
 4.6

LIST PRICE

\$546
\$591
\$637

NOTES:

- Brushed aluminum finish around low-glare porcelain coated steel magnetic writing surface.
- Brushed aluminum marker tray attaches to frame.
- Width of markerboard must correspond to the width of the panel.
- Markerboards will attach to the Abound and Accelerate® frame with brackets provided.
- Able to use multiple markerboards next to each other and multiple boards per panel.

! No color specification required.

! Porcelain Markerboard cleaning instructions: For everyday cleaning, use Chlorox wipes. Use citrus cleaner if a permanent marker is used by accident. A citrus cleaner is not recommended for everyday use as it leaves residue.

HOW TO SPECIFY

Select
Model Number

HHMRK36

DESCRIPTION

Tackboard
 20"W x 18"H
 24"W x 18"H
 30"W x 18"H
 36"W x 18"H
 42"W x 18"H
 48"W x 18"H
 60"W x 18"H
 72"W x 18"H

MODEL

HETB2018
HETB2418
HETB3018
HETB3618
HETB4218
HETB4818
HETB6018
HETB7218

SHIP WEIGHT

2
 3
 3
 8
 10
 12
 13
 15

CUBE

0.5
 0.6
 0.7
 0.9
 1.0
 1.2
 1.5
 1.8

LIST PRICE

\$118
\$144
\$168
\$191
\$214
\$235
\$259
\$285

SPECIFYING EXAMPLE: HETB2018.APN15

NOTES:

- Works with both Abound® and Accelerate® panel systems.
- Specify fabric, see pages 424-425 for fabric options.

HOW TO SPECIFY

Select
Model Number

HETB2018.

Select
Fabric Color

APN15



Icon Legend on page 19

SYSTEMS Accessories

WORKSTATIONS

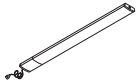

DESCRIPTION

LED Task Lights

17" LED Light with Power Supply (Single)
31" LED Light with Power Supply (Single)

17" LED Light with Power Supply for Daisy-chain (Starter)
31" LED Light with Power Supply for Daisy-chain (Starter)

17" LED Light with 8" Jumper Cord for Daisy-chain (Follower)
31" LED Light with 8" Jumper Cord for Daisy-chain (Follower)

Undercabinet Occupancy Sensor with 1" End to End Connector

MODEL

SHIP WEIGHT

CUBE

LIST PRICE

HLED17AS ⓘ
HLED31AS ⓘ

1.2 ⓘ
1.5 ⓘ

0.05
0.09

\$450
\$603

HLED17A
HLED31A

1.0 ⓘ
1.4 ⓘ

0.05
0.09

\$493
\$662

HLED17AUO ⓘ
HLED31AUO ⓘ

1.0 ⓘ
1.0 ⓘ

0.03
0.05

\$404
\$539

HLEDOSA ⓘ

0.2 ⓘ

0.01

\$97

NOTES: To use the daisy chain application, must start with model HLED17A or HLED31A. No finish specification required. Attaches magnetically to underside of overhead storage, or attaches with provided screws or double-sided tape. Occupancy sensor attaches to a single or starter LED light and will automatically turn the light off after no motion is detected for 30 minutes. Just like all the LED light models, the occupancy sensor features a soft-touch on/off switch. LED task lights have a lifetime of 50,000 hours and have a dimmer feature that allows the user to adjust the amount of light output.

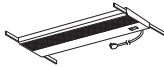

DESCRIPTION

Task Lights

- Slim profile design mounts recessed under storage unit and shelves with spring steel clips.
- T5 bulb included which contains less mercury than other types of bulbs.
- 9-foot black cord and switch off right rear corner.
- Electronic ballast for increased energy efficiency.
- 2 lights (HH870930) can be mounted under 60"W storage cabinets.

For 24"W storage cabinets or shelves,

18³/₈"W x 3¹/₁₆"D x 1¹/₈"H

HH870924(?)

5.0

0.4

\$243

\$308

For 30"W and 36"W storage cabinets or shelves,

22¹/₈"W x 3¹/₁₆"D x 1¹/₈"H

HH870930(?) ⓘ

7.0

0.6

\$247

\$322

For 42"W and 48"W storage cabinets or shelves,

34⁵/₈"W x 3¹/₁₆"D x 1¹/₈"H

HH870942(?) ⓘ

10.0

0.9

\$267

\$339

For 60"W and 72"W storage cabinets or shelves,

46¹/₂"W x 3¹/₁₆"D x 1¹/₈"H

HH870960(?)

12.0

1.1

\$290

\$361

NOTES: For additional information see the Workplace Tools section in the 2021 Shared Spaces Pricer.

ⓘ Color: Black.

BASIC (NO SUFFIX REQUIRED) **CHICAGO CODE "CH"**

Chicago Code Version — Specify: Model/"CH".
EXAMPLE: HH870924CH

DESCRIPTION

Cable Management Troughs

17"W — Single

17"W — 10-Pack

36"W — Single

36"W — 10-Pack

MODEL

SHIP WEIGHT

CUBE

LIST PRICE

HCTROUGH17

2.7

0.5

\$73

HCTROUGH1710

14.0

0.5

\$665

HCTROUGH36

4.9

0.9

\$122

HCTROUGH3610

30.0

0.9

\$1121

- Cable management troughs ship flat packed.
- The troughs attach to underneath the worksurface with screws.
- The 17"W has one wire access cut out on the user side. The 36" has two wire access cut outs. These cut outs give users access to inside the trough without having to detach it from the worksurface.
- Color: Graphite.
- Material: Metal.
- TAA Compliant.

NOTES: For additional information see the Workplace Tools section in the 2021 Shared Spaces Pricer.

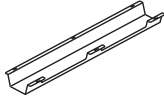
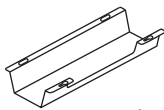

SIN 33721

SYSTEMS Accessories

GSA SIN 33721



Icon Legend on page 19

WORKSTATIONS

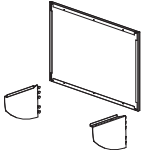

| DESCRIPTION | MODEL | SHIP WEIGHT | CUBE | LIST PRICE BY PAINT GRADE | |
|-----------------------------------|----------------|-------------|------|---------------------------|--------------|
| | | | | P1 | P2 |
| Upmount Kits for Overheads | | | | | |
| 24"W | HRVUP24 | 7.0 | 0.3 | \$171 | \$189 |
| 30"W | HRVUP30 | 8.0 | 0.3 | \$180 | \$198 |
| 36"W | HRVUP36 | 10.0 | 0.4 | \$185 | \$203 |
| 42"W | HRVUP42 | 11.0 | 0.4 | \$194 | \$212 |
| 48"W | HRVUP48 | 12.0 | 0.5 | \$202 | \$220 |
| 60"W | HRVUP60 | 16.0 | 0.6 | \$217 | \$235 |

- Includes two upmount brackets, full back panel and installation hardware.
- Brackets require a clearance of 6½" below bottom of overhead cabinet.
- Full back panel adds ½" to depth of overhead case.

! Kit width must correspond to the width of the overhead case.



| | | | | | |
|---|-----------------|--------------|-----|--------------|--------------|
| Overhead Shelf Dividers Shelf Dividers — package of 6 | H38SHFDV | 3.0 Ⓢ | 0.2 | \$167 | \$178 |
|---|-----------------|--------------|-----|--------------|--------------|

Specify paint

NOTES:

- Upmount Bracket allows mounting of Overhead Cabinet up to 15" above height of panel.
- Upmount Kits for overheads can be used with flipper or receding door overheads. See page 586.

! Upmount Kits not for use on Accelerate stackers.

HOW TO SPECIFY

| | |
|----------------------------|---------------------------|
| Select Model Number | Select Paint Color |
| See page 481 | See page 481 |
| H 3 8 S H F D V . | T 1 |

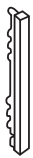

| DESCRIPTION | MODEL | SHIP WEIGHT | CUBE | LIST PRICE BY PAINT GRADE | |
|--|---------------|--------------|------|---------------------------|-------------|
| | | | | P1 | P2 |
| Cord Cover | | | | | |
| • Allows routing of task light cords. | | | | | |
| • Vertical height 10". | HECC10 | 0.7 Ⓢ | 0.2 | \$43 | \$50 |
| • Vertical height 15". | HECC15 | 1.0 Ⓢ | 0.3 | \$43 | \$50 |
| • Cord cover can be positioned into panel slots and used under task lights and under worksurfaces. | | | | | |

Specify paint

HOW TO SPECIFY

| | |
|----------------------------|---------------------------|
| Select Model Number | Select Paint Color |
| See page 481 | See page 481 |
| H E C C 1 0 . | T 1 |

ABOUND® Electrical and Data

Abound® features capabilities for cable management, including electrical, voice, and data. The 8-wire electrical system can be integrated at base pathway and beltline. The open structure of the frame allows voice and data cables to be routed both vertically and horizontally.

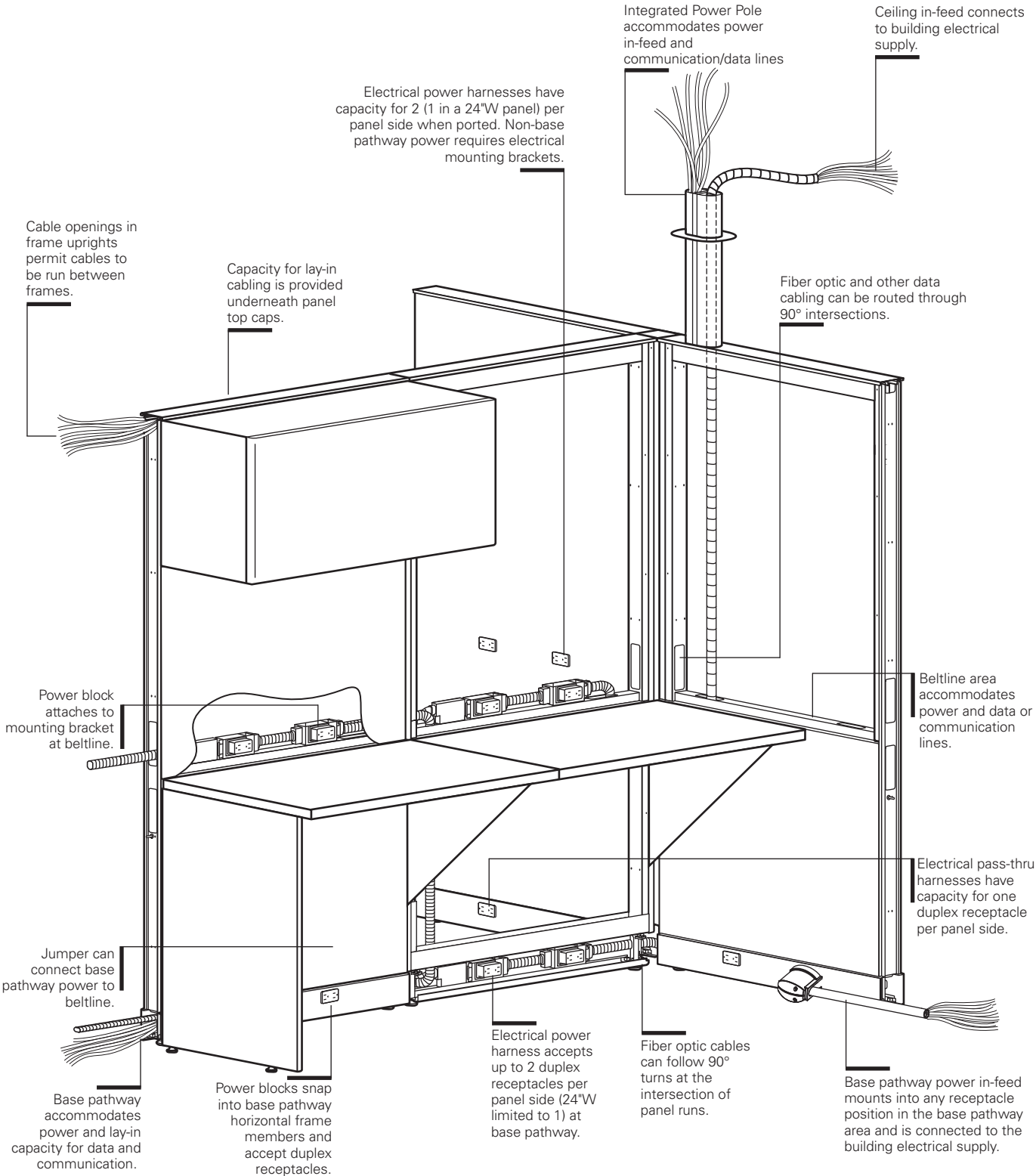

ABOUND[®] Electrical and Data

THE ABOUND ELECTRICAL SYSTEMS

Abound offers a choice of three electrical systems:

- Four-circuit, 3 + 1
- Four-circuit, 2 + 2
- Three-circuit, separate neutrals

All three systems utilize an 8-wire electrical system, rated at 20 amps per circuit (15 amps Canadian). See pages 603-604 for a detailed explanation of each electrical system.

Abound frames and electrical components are UL Listed. Electrical components are also CSA certified.

Installation and use of the electrical system, the number of receptacles used on a given circuit and connections to the building power supply should be in compliance with all local and national electrical codes.

Caution: Electrical equipment cords or extension cords MUST NOT BE ROUTED through cable openings in frame sides.

Abound's electrical harnesses are UL listed and are considered raceways themselves as defined by the National Electrical Code. This means there is no separation requirement between the electrical harnesses and communications cables per Sec. 800-52 of the National Electrical Code. Communication cables may be placed next to Abound's electrical components without a metal septum and will still meet the guidelines of the Telecommunications Industry Association for separation of power and data.

IN-FEEDS

Power in-feed cables deliver power from building to system. In-feed cables are housed in conduit to separate electrical system from communications and data lines.

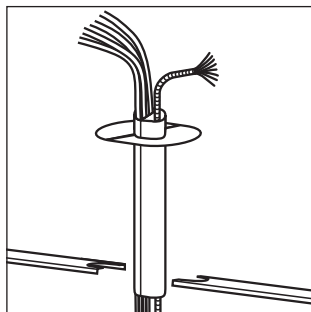

Integrated power and communications poles provide capacity for routing power supply directly through the top of any structural or stacking frame using same width trim/connector kit in place of top cap. Avoid glass or translucent tiles in upper position of frames with integrated power poles. Power pole has a cavity on each side of a center septum. When using a ceiling power in-feed, consider that the in-feed must connect into an electrical harness located in an adjacent panel. (See pages 605-606 for cable capacity.)

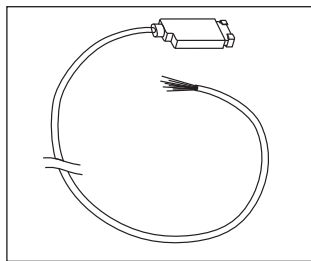

Ceiling power in-feed connects to a prewired electrical harness in the beltline or base pathway, traverses through an adjacent panel and terminates in the junction box at the top of the integrated power pole. For use with integrated power pole models HEP65 and HEP35. No portion of the flex cable can be exposed after installation.

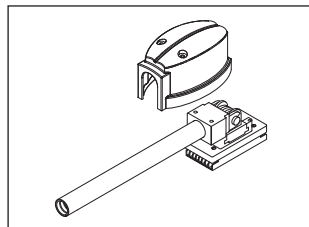

Sealtight base pathway power in-feed attaches to a receptacle opening at the base pathway. A heavy rubber sheathing shields conduit, allowing in-feed to be exposed.

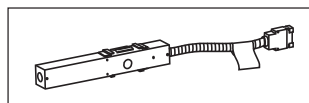

Hardwire (New York Code) power in-feed (model H871400) is used when local electrical codes require hardwire entry. When used in 24"W, 30"W and 36"W panels, power can be routed only in one direction. When used in 42", 48"W and 60"W panels, an electrical pass-thru cable or harness for that panel width can be used to route power back in the opposite direction. Unit must connect to a power or pass-thru harness positioned in the base pathway area of an adjacent panel. Customer to furnish all cabling and wiring from power entry to power source. Junction box can be positioned at any duplex receptacle location.

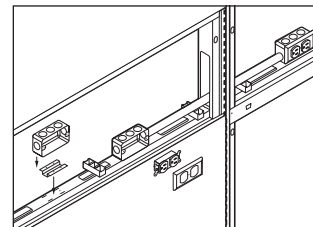

HARDWIRE (CHICAGO CODE) JUNCTION BOX

Wiring harnesses and snap connectors are not allowed in Chicago — base pathways must be comprised of all metallic components. Concealed mounting is the only option at beltline. For the base pathway, junction box (model HH873500) clips directly into receptacle locations. Customer must furnish conduit, wiring, standard duplex receptacles with metal covers for the beltline and designer-type receptacles for the base pathway. Power entry can be routed from the ceiling, via an Abound power pole, or from the floor into a junction box (model HH873500).

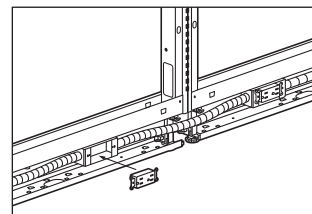

POWER

Power blocks on electrical power harness and pass-thru harness accept duplex receptacles.

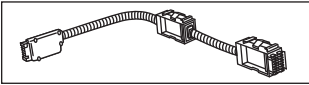

Electrical power harnesses are used to distribute power in panels. Abound electrical can be located at base pathway or beltline only. Connectors at both ends of power harnesses allow power distribution in either direction.

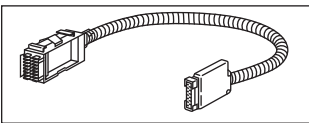

Electrical pass-thru harnesses have capacity to handle one duplex receptacle on each side of the panel when exposed.

A 60" pass-thru harness can be used to jump up to a single duplex receptacle per side at beltline and connecting to a power harness at base pathway.

Electrical power harnesses and pass-thru cables cannot be routed at 90° at beltline once frames are connected to connector blocks.

Electrical pass-thru cables distribute power through any panel where receptacles are not required. Cable length cannot be stretched.

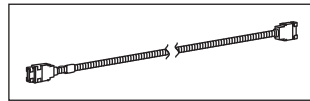

Electrical jumper cables connect power from base pathway or beltline to a harness located on any horizontal member as needed. Jumper cable plugs into power block end of electrical power harness or electrical pass-thru harness.

Model HH871366 is 66" to jump up to 30 inches vertically – base pathway to beltline or beltline to base pathway.

Jumper can also be used from beltline to adjacent beltline at 90° juncture.

POWER BLOCKS

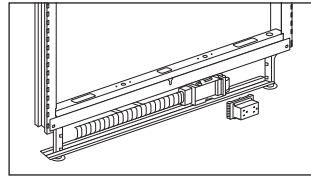

Base pathway mounting: Power blocks snap directly onto brackets in base pathway area.

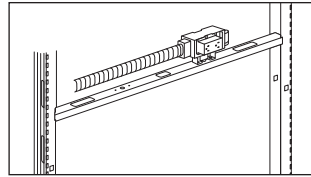

Beltline electrical mounting: For ported receptacles at beltline mount power blocks onto Electrical Mounting Brackets which screw into the panel frame. Electrical Mounting Brackets must be ordered separately. Data/Electrical Port Tiles must be used where exposed receptacles will be located.

RECEPTACLES

Duplex receptacles snap into power blocks of power harnesses or pass-through harnesses. Duplexes are available in multiple colors. Each receptacle is labeled to indicate which circuit it will be connected to.

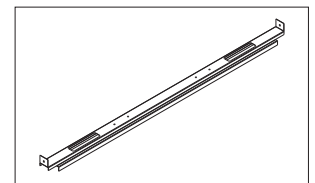
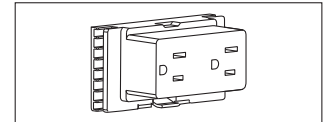

OPTIONAL STIFFENER SUPPORT Stiffener supports can be used to provide additional rigidity to a panel when fabric tiles are on both sides of the frame. May also be used for routing power/data at non-standard heights.

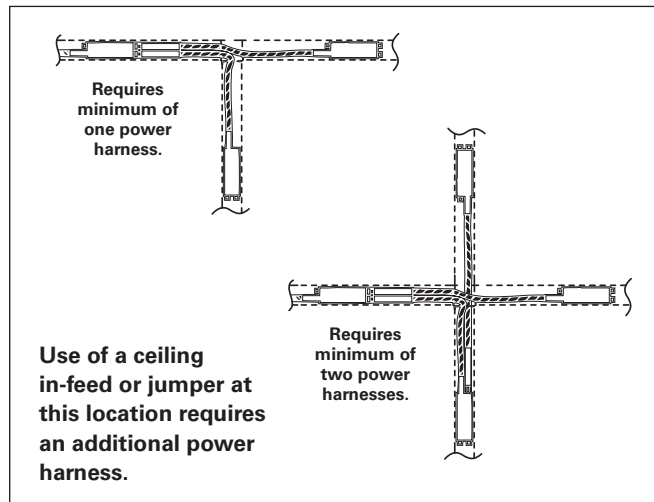

All electrical power harnesses and pass-thru harnesses will stretch 3½", allowing them to span "T" and "X" intersections and "S" extended straight connections.

ACCELERATE® Electrical and Data

WORKSTATIONS

Accelerate® features capabilities for cable management, including electrical, voice, and data. The 8-wire electrical system can be integrated at base pathway. See Systems electrical pages 608-613 for electrical models to be used with Accelerate® Systems products. See page 444 for Abound® frame horizontal and vertical wire capacity and page 606 for base pathway capacity.

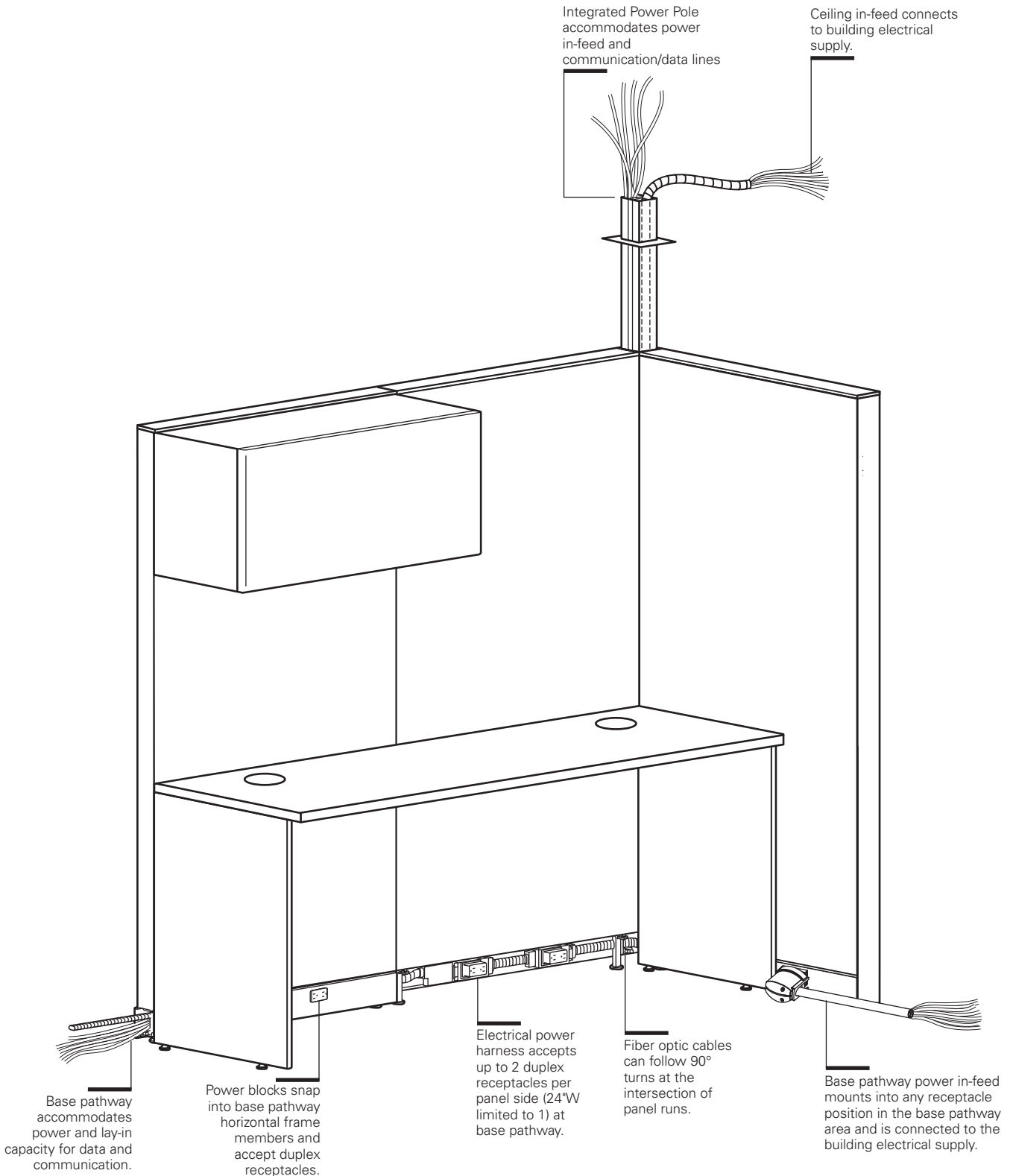

THE ACCELERATE ELECTRICAL SYSTEMS

Accelerate offers a choice of three electrical systems:

- Four-circuit, 3 + 1
- Four-circuit, 2 + 2
- Three-circuit, separate neutrals

All three systems utilize an 8-wire electrical system, rated at 20 amps per circuit (15 amps Canadian). See pages 603-604 for a detailed explanation of each electrical system.

Accelerate panels and electrical components are UL Listed. Electrical components are also CSA certified.

Installation and use of the electrical system, the number of receptacles used on a given circuit and connections to the building power supply should be in compliance with all local and national electrical codes.

Caution: Electrical equipment cords or extension cords MUST NOT BE ROUTED through cable openings in frame sides.

Accelerate's electrical harnesses are UL listed and are considered raceways themselves as defined by the National Electrical Code. This means there is no separation requirement between the electrical harnesses and communications cables per Sec. 800-52 of the National Electrical Code. Communication cables may be placed next to Accelerate's electrical components without a metal septum and will still meet the guidelines of the Telecommunications Industry Association for separation of power and data.

IN-FEEDS

Power in-feed cables deliver power from building to system. In-feed cables are housed in conduit to separate electrical system from communications and data lines.

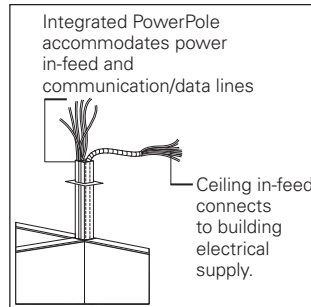

Integrated power and communications poles provide capacity for routing power supply directly through the top of any connector. When using a ceiling power in-feed, consider that the in-feed must connect into an electrical harness located in an adjacent panel. (See pages 605-606 for cable capacity.)

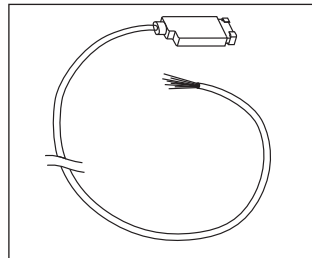

Ceiling power in-feed connects to a prewired electrical harness in the beltline or base pathway, traverses through an adjacent panel and terminates in the junction box at the top of the integrated power pole. For use with integrated power pole models HECPP. No portion of the flex cable can be exposed after installation.

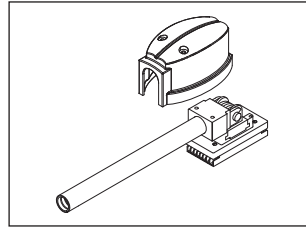

Sealtight base pathway power in-feed attaches to a receptacle opening at the base pathway. A heavy rubber sheathing shields conduit, allowing in-feed to be exposed.

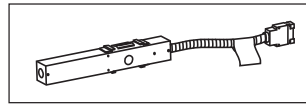

Hardwire (New York Code) power in-feed (model H871400) is used when local electrical codes require hardwire entry. When used in 24"W, 30"W and 36"W panels, power can be routed only in one direction. When used in 42", 48"W and 60"W panels, an electrical pass-thru cable or harness for that panel width can be used to route power back in the opposite direction. Unit must connect to a power or pass-thru harness positioned in the base pathway area of an adjacent panel. Customer to furnish all cabling and wiring from power entry to power source. Junction box can be positioned at any duplex receptacle location.

HARDWARE (CHICAGO CODE) JUNCTION BOX

Wiring harnesses and snap connectors are not allowed in Chicago — base pathways must be comprised of all metallic components. Concealed mounting is the only option at beltline. For the base pathway, junction box (model HH871500) clips directly into receptacle locations. Customer must furnish conduit, wiring, standard duplex receptacles with metal covers for the beltline and designer-type receptacles for the base pathway. Power entry can be routed from the ceiling, via an Accelerate power pole, or from the floor into a junction box (model HH871500). See Systems electrical pages 608-613 for electrical models to be used with Accelerate® Systems products.

DUPLEX RECEPTACLES

For Duplex Receptacle models that can be used on Accelerate® panel systems, please see page 611.

All Systems electrical components can be found on pages 608-613.

SYSTEMS

Electrical and Data

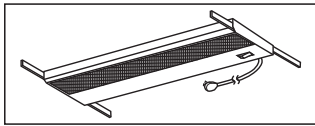

LIGHTING

Task lights can be recessed under storage cabinets or storage shelves.

Task lights in four sizes are available to correspond to cabinet or shelf width. They have 9' power cords in black, connected in the right rear corner. All models feature electronic ballast for longer bulb life and cooler operating temperature. Task lights with a fused plug to meet Chicago electrical code are also available.

Recommendation: Provide a separate circuit for task lights for proper long-term operation without RF interference to computers that may be in use.

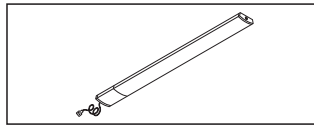

LED TASK LIGHTS

No finish specification required. Attaches magnetically to underside of overhead storage, or attaches with provided screws.

Occupancy sensor attaches to a single or starter LED light and will automatically turn the light off after no motion is detected for 30 minutes.

Just like all the LED light models, the occupancy sensor features a soft-touch on/off switch. LED task lights have a lifetime of 50,000 hours and have a dimmer feature that allows the user to adjust the amount of light output.

Daisy chain options are available. To use the daisy chain application, must start with model HLED17A or HLED31A.

VOICE/DATA RECEPTACLES

Abound not only provides space for large volumes of voice and data cables, it also offers several means of mounting commercially available voice and data components.

Commercially available modular data faceplates can be mounted in vacant base receptacle openings or can be mounted in data/electrical port tiles above or below the worksurface.

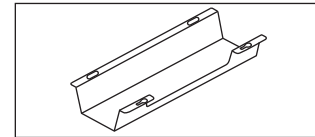

Cable management troughs attach to worksurfaces with provided screws. The graphite metal troughs are designed with cord access cut outs. These cut outs give users access to inside the trough without having to detach it from the worksurface.

SYSTEMS ELECTRICAL SPECIFYING INFORMATION

To Order:

- Determine which electrical system you will use after consulting your electrician and computer support personnel:
 - The Four-circuit system (4-Hot/2-Neutral/2-Ground)**
 - 3 + 1 option
 - 2 + 2 option
 - The Three-circuit system (3-Hot/3-Neutral/2-Ground)**
- Determine location, quantity and circuit of duplexes.
- Determine the appropriate choice and use of Isolated, Isolated/Dedicated and Separate Neutral circuits.
- Specify appropriate Power Harnesses* and Pass-Thru Cables.*
- Determine the location, quantity and type of Power In-feed needed.

* Select Power Harness models (HH8712XX) and Pass-Thru Cables (HH8711XX) with the last two digits being 1" (or 2") smaller than the associate panel width.

Electrical System Options

The four-circuit, eight-wire electrical system is widely specified and trusted by hundreds of thousands of end-users. This proven system delivers four circuits for every power in-feed in either a 3 + 1 or 2 + 2 configuration. The isolated/dedicated circuits are ideal for sensitive computing equipment, while the common circuits are suitable for faxes, copiers, task lights and other peripherals.

Both the 3 + 1 and 2 + 2 systems use the same pre-wired components, making it easy to adjust as electrical needs change.

You can also choose a three-circuit, eight-wire system that has a dedicated neutral for every hot circuit. The three-circuit components have model numbers with an "A" suffix and appear in a gray box in this pricer.

Four-circuit, 3 + 1 Receptacle Option

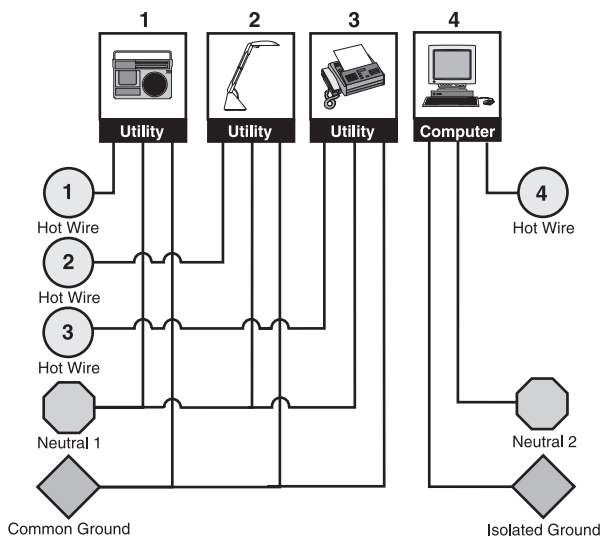

The 3 + 1 option is the electrical standard used by The HON Company for many years in most of their systems products. This wiring option provides three utility circuits plus an isolated/dedicated circuit for more sensitive equipment.

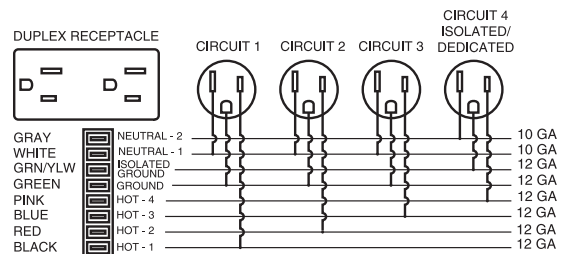

Four-circuit, 2 + 2 Receptacle Option

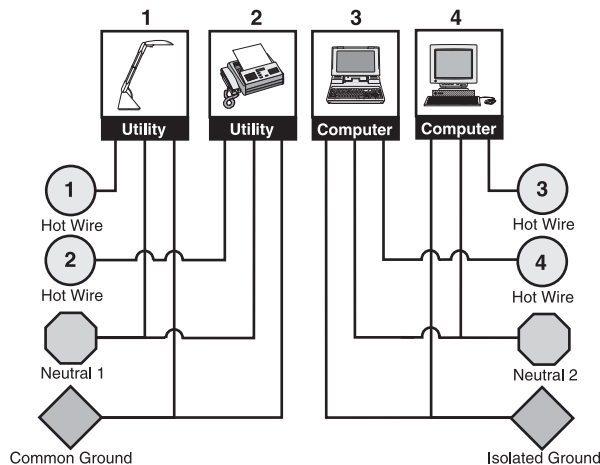

The 2 + 2 option is a wiring option that provides two utility circuits and two isolated circuits for more extensive computer usage applications.

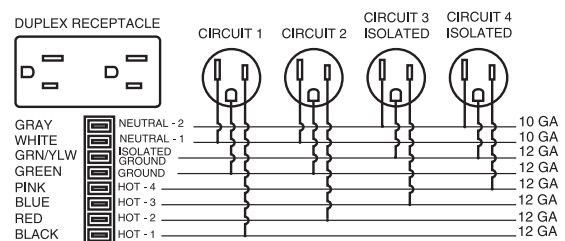

SYSTEMS ELECTRICAL SPECIFYING INFORMATION

Three-circuit, separate neutrals

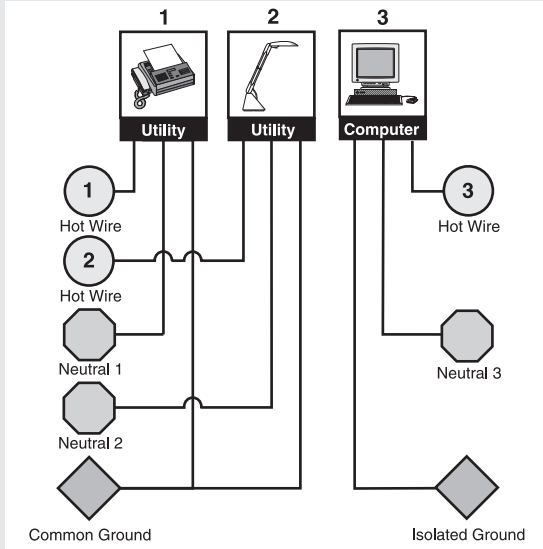

The Three-circuit, separate neutrals configuration is a wiring option that provides separate neutrals for each of the three circuits. Two circuits share a common ground, and one circuit is isolated/dedicated. The three-circuit components have model numbers with an "A" suffix and appear in a gray box in this pricer.

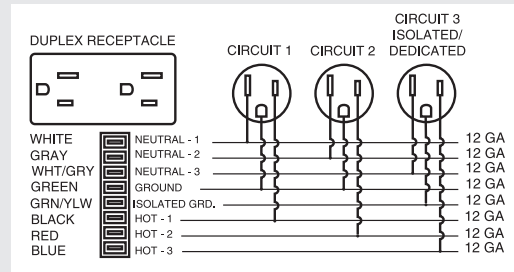

| Two 8-wire, 20 AMP (15 AMP Canadian) electrical systems are offered | | | | | |
|--|--------------------------------|---|--|--|---|
| Electrical System | Circuitry | Receptacle Capacity | | | |
| Four-circuit 4-Hot/2-Neutral/2-Ground (10 gauge neutral wires) | 3 + 1 | Common Circuit-1 HH873501 | Common Circuit-2 (1) HH873502 | Common Circuit-3 HH873503 | Iso/Dedicated Circuit-4 HH873504 |
| | 2 + 2 | Common Circuit-1 HH873501 | Common Circuit-2 HH873502 | Isolated Circuit-3 HH873506 | Isolated Circuit-4 HH873504 |
| Three-circuit 3-Hot/3-Neutral/2-Ground (12 gauge neutral wires) | w/separate neutrals | Common Circuit-1 HH873501A | Common Circuit-2 HH873502A | Iso/Dedicated Circuit-3 HH873503A | N/A |

(1) Circuit-2 (one of the 3 common circuits sharing a neutral wire) cannot be used with a single-phase building electrical supply.

Notes:

- Four-circuit components and three-circuit components (with suffix "A") cannot be used together.
- Components of the two systems are keyed differently to prevent components of one system from being connected to components of another system.
- HON Cat. Nos. are printed on the UL labels, and components are color-coded to provide visual identification of the different components.
- Four-circuit components have black plastic parts.
- Three-circuit components have rust-colored terminal ends and receptacle backs are rust colored.

Typical power usage by the most commonly specified office equipment.

Source: Industry Analysis, Inc., Rochester, NY

| EQUIPMENT | AMPS | EQUIPMENT | AMPS | EQUIPMENT | AMPS |
|-------------------|------|------------------------|-------------|---------------------|-------------|
| Computers | | Copiers | | FAX Machines | |
| Personal Computer | 3 | Desktop Copier | 15 | InkJet FAX | less than 1 |
| Notebook Computer | 3 | Console Copier | 20 | Thermal FAX | less than 1 |
| | | Copier/Duplicator | 30 | Plain paper FAX | 8 |
| Monitors | | Printers | | Task Lights | |
| 13" Color Monitor | 2 | Dot Matrix | less than 1 | 36" T8 Fluorescent | 0.2/bulb |
| 17" Color Monitor | 3 | InkJet | less than 1 | 48" T8 Fluorescent | 0.3/bulb |
| 21" Color Monitor | 4 | Personal Laser or LED | 8 | | |
| | | Workgroup Laser or LED | 15 | | |

Duplex Receptacles



15 AMP Receptacle

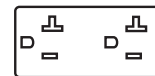

20 AMP Receptacle
(Required by some large copiers.)

SYSTEMS ELECTRICAL SPECIFYING INFORMATION

- Abound and Accelerate panels are UL listed.
- Electrical components are UL Listed and CSA Certified.
- It is the customer's responsibility to ensure that use of the pre-wired electrical system, the number of receptacles used on a given circuit, and connection to a building power source, be in compliance with all local and national electrical codes.
- Contact Customer Service for additional information.
- Pedestals and Lateral Files, positioned under worksurfaces, may render some receptacles inaccessible, and may prohibit use of grommets.
- Four-circuit components and Three-circuit components (with suffix "A") cannot be used together. See pages 603-604.
- Three-way panel connections require at least one power harness.
- Four-way panel connections require at least two power harnesses.
- ! A licensed electrician must make connections to a building electrical supply.

Definition of components:

Electrical Power Harness

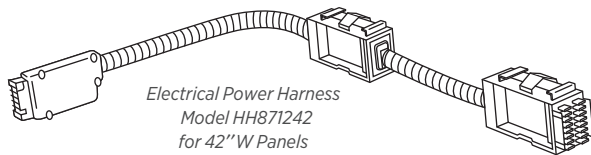

- Used to distribute power in panels.
- Power distribution in either direction.
- Specify Power Harness to match panel width.
- Double-sided: receptacles can be inserted into both sides of Power Blocks.

- ! Three-way panel connections require at least one power harness.
- ! 4-way panel connections require at least two power harnesses.

Electrical Pass-Thru Cables

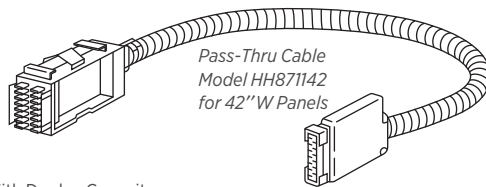

Pass-Thru Cable With Duplex Capacity:

- Use in panels where multiple receptacles are not required.
- Added feature: has capacity for one receptacle on each side of a panel. Feature offers future expansion and is an alternative to Power Harnesses.

Various Electrical Layouts



Straight Line

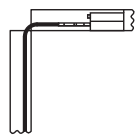

90 Degree Corner

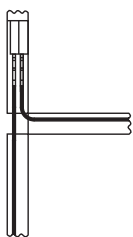

"T" Connection

When ending power in two return panels, wiring pigtails must be returned to original panel run.

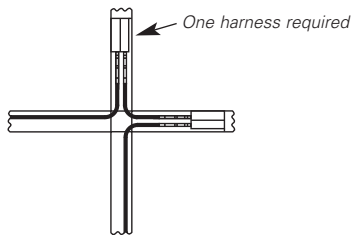

"X" or Cross Connection

To power a 4-way panel connection from one direction, specify at least two double block harnesses.

Duplex Receptacles

- 15 amp outlet configuration.
- Models HH871601 and HH871601A have a 20 amp outlet configuration.
- Fit back-to-back into the Power Block(s) of Power and Pass-Thru Harnesses.
- Labeled with the provided circuit. Circuits connected to the Isolated Ground are identified with an orange triangle; circuits that do not share a neutral or ground have an orange circuit number.

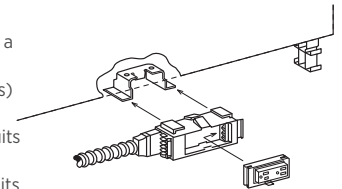

Power In-Feed (Base) Models HH879072 (72") and HH879168 (168")

- Used to connect the panel electrical system to the building electrical supply at a power block.
- Plugs into any receptacle position; can be rotated Left or Right.
- Conduit is UL listed Black Liquid-tight conduit (outside diameter is 7/8").

- ! A licensed electrician must make connections to a building electrical supply.
- ! Must be positioned through a receptacle opening in the baserail cover, prior to an electrician connecting to the power source.

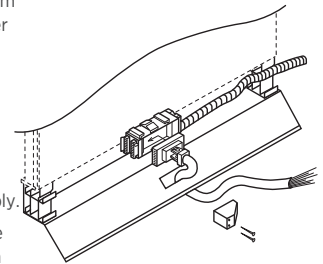

Power In-Feed Model (Ceiling) HH871912 and HH871918

- Used to connect the panel electrical system to the building electrical supply.

- ! A licensed electrician must make connections to a building electrical supply.
- ! Model uses UL recognized flex-cable conduit — no portion can be left exposed (i.e., must be in a power pole).
- ! Power Pole must be ordered separately.



HH871972

Note: In-feed cables listed above may be field-cut to desired length.

Electrical Jumper Cables

- ! When used to connect power between the base pathway and the beltline area, the jumper must be connected to a power block at one end of a run, routed into an adjacent panel that does not contain a power harness, then routed back into the panel containing a power harness or pass-thru cable and connected to a power harness in the other pathway.

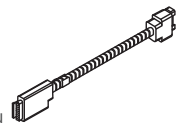

HH871366

Abound Electrical Mounting Brackets

- Use to mount ported receptacles at beltline.
- Screw into the panel frame.
- ! One mounting bracket required at beltline for each 24" W pass-thru or power harness. Two required for 30"-60" W power harness.

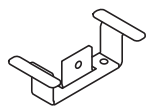

HH8988EBN

WORKING WITH CABLE MANAGEMENT

Base Pathway Receptacle Locations

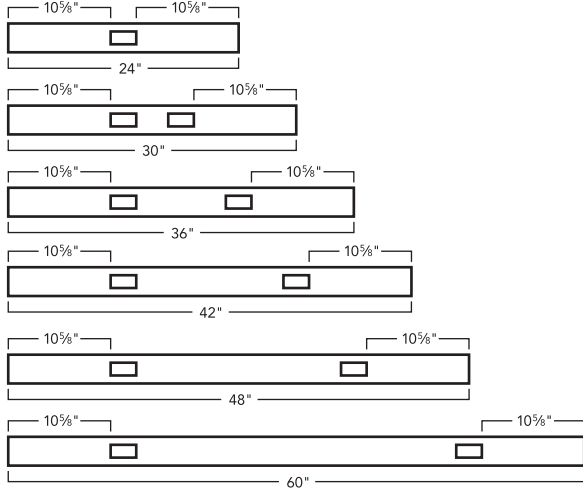

Abound® Lay-in Cable Capacity

The top and base pathway allow continuous voice and data lines to run through and between panels without interruption. Lay-in is provided for environments where systems furniture or cabling are subject to frequent change. All capacities are for Cat 6 cable with a 0.25" diameter.

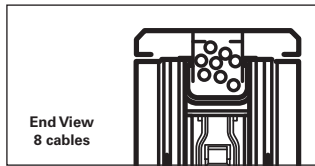

End View
8 cables
Top pathway accepts up to 8 voice/data cables (.25" dia.).

Abound® Cable Capacity

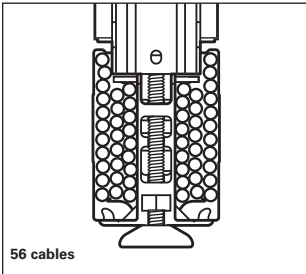

56 cables
Abound® base pathway accepts up to 56 voice/data cables (.25" dia.) (6.03 sq. in.) at 60% fill.

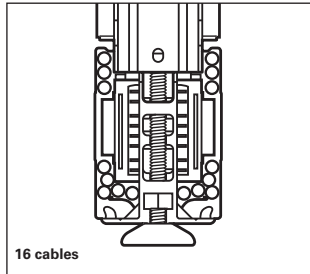

16 cables
When electrical system shares base pathway, the cable capacity in Abound is reduced to 16 cables (2.25 sq. in.). Cable quantities listed are at 60% fill ratio.

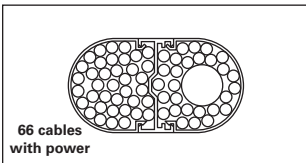

66 cables with power
Cable capacity of the power pole, in addition to electrical in-feed is 2.79 sq. in. on one side and 2.91 sq. in. on the other for a total capacity of 66 cables with power of .25" diameter.

Circuit Usage

Strategy 1

Circuits to Equipment

Assign specific uses for each of the circuits:

- For example, in a four-circuit system:
Circuit 1 – Calculators, fans, etc.
Circuit 2 – Task lights (could be wired to wall switch)
Circuit 3 – Computer monitors
Circuit 4 – CPUs

Strategy 2

Circuits to Workstations

Assign specific workstations to each of the three available circuits. Use circuit 4 for power-sensitive electronic equipment.

Placement of pedestals and lateral files may render some duplex locations inaccessible. Pedestal placement may also affect compatibility with pull-up receptacles.

Abound® Lay-In Cable Capacity

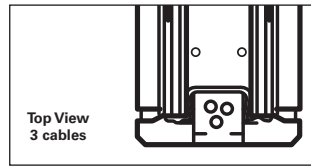

Top View
3 cables
Variable height junctions accept up to 3 voice/data cables (.25" dia.).

Accelerate® Cable Capacity

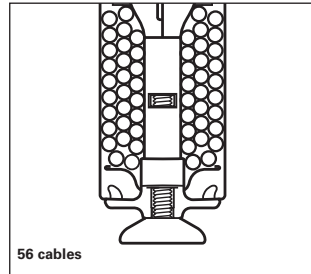

56 cables
Accelerate® base pathway accepts up to 56 voice/data cables (.25" dia.) (6.27 sq. in.) at 60% fill.

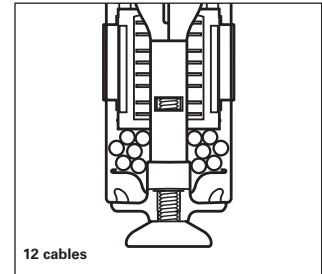

12 cables
When the electrical system shares the base pathway, the cable capacity in Accelerate® is reduced to 12 cables (.25" dia.) (2.03 sq. in.) at 60% fill ratio.

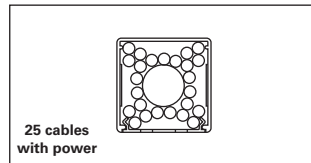

25 cables with power
Integrated Power Pole: 2" x 2" overall, 3.3"² interior accommodates a total of 25 cables with power of .25" diameter. Available in two heights: 6'6" or 13', the power pole connects via the universal connector and the overall height is the sum of the connector and the power pole. Constructed of aluminum with a powder coat paint finish in the specified color. Power pole requires a Ceiling In-Feed.

Ceiling In-Feeds: UL

listed as raceways. This means the electrical components are completely shielded and meet any requirements for separation of electrical components and communications cables per Section 800-52 of the National Electrical Code.

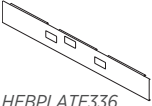
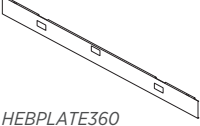
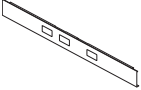
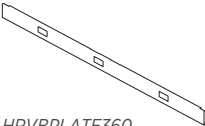

SYSTEMS Electrical Components

| | DESCRIPTION | MODEL | SHIP WEIGHT | CUBE | LIST PRICE BY PAINT GRADE | | |
|---|---|---|---------------------|------|---------------------------|--------------|-------------|
| | | | | | P1 | P2 | |
|  HEBPLATE336 | Accelerate® Base Pathway Cover w/Additional Knockout | | | | | | |
| | 36"W | HEBPLATE336 | 7 | 0.4 | \$82 | \$92 | |
| | 42"W | HEBPLATE342 | 8 | 0.4 | \$84 | \$94 | |
| | 48"W | HEBPLATE348 | 9 | 0.4 | \$88 | \$98 | |
| | 60"W | HEBPLATE360 | 11 | 0.5 | \$100 | \$110 | |
|  HEBPLATE360 | 72"W | HEBPLATE372 | 14 | 0.6 | \$111 | \$121 | |
| | NOTES: Specify paint, see page 481. SPECIFYING EXAMPLE: HEBPLATE336.T4 | | | | | | |
| | <hr/> | | | | | | |
| |  HRVBPLATE336 | Abound® Base Pathway Cover w/Additional Knockout | | | | | |
| | | 36"W | HRVBPLATE336 | 7 | 0.4 | \$81 | \$91 |
| 42"W | | HRVBPLATE342 | 8 | 0.4 | \$83 | \$93 | |
| 48"W | | HRVBPLATE348 | 9 | 0.4 | \$86 | \$96 | |
|  HRVBPLATE360 | 60"W | HRVBPLATE360 | 11 | 0.5 | \$99 | \$109 | |
| | NOTES: Specify paint, see page 423. SPECIFYING EXAMPLE: HRVBPLATE336.T4 | | | | | | |

NOTES:

- ❗ Specify Pathways to match trim color.
- ❗ Standard raceways with two knockouts are standard on panels. If additional three knockout kickplate is ordered, the two port version can be saved or discarded.

HOW TO SPECIFY

| | |
|---|--|
| <p>Select Model Number</p> <p>H E B P L A T E 3 3 6 .</p> | <p>Select Paint Color</p> <p>See page 481</p> <p>T 4</p> |
|---|--|

SYSTEMS

Electrical Components

GSA SIN 33721



Icon Legend on page 19

WORKSTATIONS

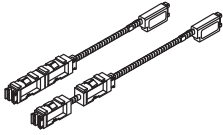

| DESCRIPTION | MAX. RECEPT. CAP. PER PANEL SIDE | MODEL | | SHIP WEIGHT | CUBE | LIST PRICE |
|---|--|--------------------------------|--|----------------|------|---------------|
| | | FOUR-CIRCUIT 3 + 1 2 + 2 | THREE-CIRCUIT, SEPARATE NEUTRALS | | | |
| Electrical Power Harnesses, Frames — w/duplex capacity | | | | | | |
| For 24"W | 1 | HH871224 | HH871224A | 2.0 | 0.5 | \$227 |
| For 30"W | 2 | HH871230 | HH871230A | 2.0 | 0.5 | \$227 |
| For 36"W | 2 | HH871236 | HH871236A | 2.5 | 0.5 | \$227 |
| For 42"W | 2 | HH871242 | HH871242A | 3.0 | 0.5 | \$239 |
| For 48"W | 2 | HH871248 | HH871248A | 3.0 | 0.5 | \$239 |
| For 60"W | 2 | HH871260 | HH871260A | 3.0 | 0.5 | \$239 |
| For 72"W (for use with Accelerate® 72"W panels only) | 2 | HH871272 | HH871272A | 5.0 | 0.5 | \$239 |

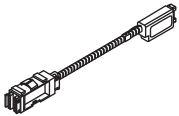

| | | | | | | |
|--|---|----------|-----------|-----|-----|-------|
| Electrical Pass-Thru Cables, Frames — w/duplex capacity | | | | | | |
| For 24"W | 1 | HH871124 | HH871124A | 2.0 | 0.5 | \$143 |
| For 30"W | 1 | HH871130 | HH871130A | 2.0 | 0.5 | \$143 |
| For 36"W | 1 | HH871136 | HH871136A | 2.0 | 0.5 | \$143 |
| For 42"W | 1 | HH871142 | HH871142A | 2.5 | 0.5 | \$151 |
| For 48"W | 1 | HH871148 | HH871148A | 2.5 | 0.5 | \$151 |
| For 60"W | 1 | HH871160 | HH871160A | 3.0 | 0.5 | \$151 |
| For 72"W (for use with Accelerate® 72"W panels only) | 1 | HH871172 | HH871172A | 5.0 | 0.5 | \$151 |

NOTES: For use when data will be terminated in one cutout in the panel.

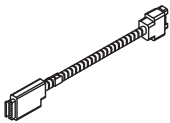

| | | | | | | |
|---|---|----------|-----------|-----|-----|-------|
| Electrical Pass-Thru Harness without Power Block | | | | | | |
| For 24"W Frames | 0 | HH871024 | HH871024A | 2.0 | 0.5 | \$132 |
| For 30"W Frames | 0 | HH871030 | HH871030A | 2.0 | 0.5 | \$132 |
| For 36"W Frames | 0 | HH871036 | HH871036A | 2.0 | 0.5 | \$132 |
| For 42"W Frames | 0 | HH871042 | HH871042A | 3.0 | 0.5 | \$137 |
| For 48"W Frames | 0 | HH871048 | HH871048A | 3.0 | 0.5 | \$137 |
| For 60"W Frames | 0 | HH871060 | HH871060A | 3.0 | 0.5 | \$137 |
| For 72"W Frame Runs | 0 | HH871072 | | 4.0 | 0.5 | \$189 |

NOTES:

- Duplex receptacles on page 611.
- Electric harnesses are intended for use with HON Systems furniture and are approved under GSA SIN 33721. When purchased separately and used without HON Systems furniture, the models are considered Open Market.

! Four-circuit components and three-circuit components (with "A" suffix) not designed to be used together. See pages 603-604.

HOW TO SPECIFY

Select
Model Number



Select
Color

See page 481

HH871048 . P

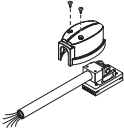
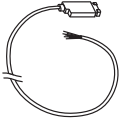
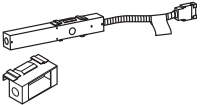

SYSTEMS Electrical Components

| | DESCRIPTION | MODEL | | SHIP WEIGHT | CUBE | LIST PRICE |
|--|---|--------------------------------|--|-------------|------|--------------|
| | | FOUR-CIRCUIT 3 + 1 2 + 2 | THREE-CIRCUIT, SEPARATE NEUTRALS | | | |
|  | Electrical Jumper Cables Jumper for up to 36" vertical jump, 66" long | HH871366 | HH871366A | 3.0 | 0.5 | \$154 |
|  | Power In-Feed Cables — Base In-Feed 72" long conduit, Sealtight Cable — 7/8" diameter | HH879072 ⓘ | HH879072A | 4.5 | 0.3 | \$253 |
| | 168" long conduit, Sealtight Cable — 7/8" diameter | HH879168 | HH879168A | 9.0 | 0.4 | \$589 |
|  | Ceiling In-Feed 144" long conduit, Flex Cable — 7/8" dia. | HH871912 ⓘ | HH871912A | 4.0 | 0.5 | \$263 |
| | 216" long conduit, Flex Cable — 7/8" dia. | HH871918 | HH871918A | 4.0 | 0.5 | \$342 |
| | ⓘ Must be used with Power Pole. Power in-feed models HH871912 and HH871918 plug into the end of any power block. No portion of the cable can be exposed after installation. | | | | | |
|  | Hardwire Applications | | | | | |
| | Hardwire Power In-feed | HH871400 ⓘ | HH871400A | 4.0 | 0.3 | \$247 |
| | ⓘ Customer to furnish all cabling and wiring from power entry to power source (approved for use by city of New York). | | | | | |
|  <i>Use when local codes require</i> | Hardwire Junction Box (6-pack) | HH871500 ⓘ | | 4.5 | 0.1 | \$526 |
| | ⓘ For use with Accelerate® and Abound® Beltline only. ⓘ Hardwire Junction Boxes cannot be installed back-to-back in panel applications. | | | | | |
| | Hardwire Junction Box (6-pack) | HH873500 | | 4.5 | 0.2 | \$491 |
| | ⓘ For use with Abound® Raceway panels only. | | | | | |
| | NOTES: Junction Box can be positioned at any Duplex Receptacle location in 30"W or wider panels. | | | | | |
| | ⓘ Contact Tailored Solutions for back-to-back Junction Box standard special number. | | | | | |

NOTES:

- Duplex receptacles on page 611.
- ⓘ Four-circuit components and three-circuit components (with "A" suffix) not designed to be used together. See pages 603-604.
- ⓘ To connect power between the base pathway and the beltline area on Abound, four-circuit jumper cables (H8713xx) must be connected to a power block at one end of a run, routed into an adjacent panel that contains no power harness, then routed back into the panel that contains a power harness (or pass-thru cable), and connected to a power harness in the other pathway.

HOW TO SPECIFY

| | |
|--|--|
| <p>Select Model Number</p> <p>HH871366 .</p> | <p>Select Color</p> <p>See page 481</p> <p>P</p> |
|--|--|

SYSTEMS

Electrical Components

GSA SIN 33721



Icon Legend on page 19

WORKSTATIONS



DESCRIPTION

Abound® Integrated Power Pole
For 35"H-50"H Frames. Poles are 78"H.
For 65"H-95"H Frames. Poles are 52"H.

NOTES: Power Pole includes ceiling trim piece.

MODEL

SHIP WEIGHT

CUBE

LIST PRICE BY PAINT GRADE

| | | | |
|--------------|-----|-----|--------------|
| HEP35 | 9 Ⓢ | 0.6 | \$422 |
| HEP65 | 6 Ⓢ | 0.4 | \$298 |

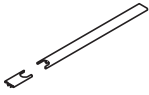

Power Pole Trim Kit (Abound® only)

24"W
30"W
36"W
42"W
48"W
60"W

| | | | |
|----------------|-----|-----|--------------|
| HRVP24P | 2 Ⓢ | 0.3 | \$149 |
| HRVP30P | 3 Ⓢ | 0.4 | \$157 |
| HRVP36P | 4 Ⓢ | 0.5 | \$165 |
| HRVP42P | 5 Ⓢ | 0.5 | \$168 |
| HRVP48P | 6 Ⓢ | 0.6 | \$173 |
| HRVP60P | 7 Ⓢ | 0.7 | \$184 |

DESCRIPTION

Power Pole — w/o Receptacles (Voi® only)
10'5"

MODEL

SHIP WEIGHT

CUBE

LIST PRICE

| | | | |
|-----------------|----|-----|--------------|
| HH870070 | 14 | 0.5 | \$477 |
|-----------------|----|-----|--------------|

• Used for routing In-Feed Cable from ceiling to panel baserail. Double cavity, plus conduit of In-Feed Cable serves as the division of electrical and communications cabling.



Specify paint color for HH870070, not available in Putty



DESCRIPTION

Accelerate® Integrated Power Pole
78"H x 2"W x 2"D
156"H x 2"W x 2"D

MODEL

SHIP WEIGHT

CUBE

LIST PRICE BY PAINT GRADE

| | | | | | |
|-----------------|------|-----|--------------|--------------|--------------|
| HECPP Ⓢ | 14 Ⓢ | 0.5 | \$305 | \$325 | \$327 |
| HECPP156 | 28 Ⓢ | 1.0 | \$736 | \$756 | \$758 |



DESCRIPTION

Receptacle Cover Replacements
Quantity 25

MODEL

SHIP WEIGHT

CUBE

LIST PRICE

| | | | |
|-----------------|-----|-----|-------------|
| HEREPCVR | 1 Ⓢ | 0.1 | \$82 |
|-----------------|-----|-----|-------------|

- ⚠ For use with Accelerate® panels only.
- ⚠ Specify Color — Available in Black (P), Muslin (T3) and Shadow (SHDW) only.

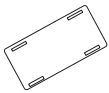

HOW TO SPECIFY

Select Model Number

Select Paint Color

See page 481

HRVP24P.

T4



SYSTEMS Electrical Components



Each marked with Circuit Number

| DESCRIPTION | MODEL | | SHIP WEIGHT | CUBE | LIST PRICE |
|---|--------------------------------|--|-------------|------|------------|
| | FOUR-CIRCUIT 3 + 1 2 + 2 | THREE-CIRCUIT, SEPARATE NEUTRALS | | | |
| Abound® Duplex Receptacles | | | | | |
| Circuit 1 | HH873501 | HH873501A | 0.5 | 0.1 | \$47 |
| Circuit 2 | HH873502 | HH873502A | 0.5 | 0.1 | \$47 |
| Circuit 3 | HH873503 | HH873503A | 0.5 | 0.1 | \$47 |
| Circuit 4 — isolated, dedicated circuit | HH873504 | | 0.5 | 0.1 | \$47 |
| Circuit 1 — 20 amp outlet | HH871601 | HH871601A | 1.0 | 0.1 | \$47 |
| Circuit 3 (2 + 2) | HH873506 | | 0.5 | 0.1 | \$47 |

Specify color.

❗ Duplex receptacle models above are for use with Abound® models only.



Each marked with Circuit Number

| DESCRIPTION | MODEL | | SHIP WEIGHT | CUBE | CORE LIST PRICE |
|---|--------------------------------|--|-------------|------|-----------------|
| | FOUR-CIRCUIT 3 + 1 2 + 2 | THREE-CIRCUIT, SEPARATE NEUTRALS | | | |
| Accelerate® Duplex Receptacles | | | | | |
| Circuit 1 | HH871501 ☉ | HH871501A | 1.0 | 0.5 | \$47 |
| Circuit 2 | HH871502 ☉ | HH871502A | 1.0 | 0.5 | \$47 |
| Circuit 3 (except 2 + 2 — see below) | HH871503 ☉ | HH871503A | 1.0 | 0.5 | \$47 |
| Circuit 4 — isolated, dedicated circuit | HH871504 | | 1.0 | 0.5 | \$47 |
| Circuit 1 (20 amp outlet configuration) | HH871601 | | 1.0 | 0.5 | \$47 |
| Circuit 3 (2 + 2) | HH871506 | | 1.0 | 0.5 | \$47 |

Specify Paint.

NOTES: Use with Accelerate® models.

SPECIFYING EXAMPLE: HH871501.S

See page 481 for color options.



| DESCRIPTION | MODEL | | SHIP WEIGHT | CUBE | LIST PRICE |
|---------------------------------|--------------------------------|--|-------------|------|------------|
| | FOUR-CIRCUIT 3 + 1 2 + 2 | THREE-CIRCUIT, SEPARATE NEUTRALS | | | |
| Data/Electrical Port Kit | | | | | |
| Specify color | HHT2DP | | 1.0 | 0.1 | \$28 |

NOTES:

- Data/Electrical Port Kit used for field installations of additional data accessories.
- ❗ Four-circuit components and three-circuit components (with "A" suffix) not designed to be used together. See pages 603-604.

Maximum Receptacle Capacity in Abound Panel Base Raceways

| Widths | 24 | 30 | 36 | 42 | 48 | 60 |
|--------------------------------------|----|----|----|----|----|----|
| Maximum of 1 duplex per panel side | X | | | | | |
| Maximum of 2 duplexes per panel side | | X | X | X | X | X |

| Duplex Color Recommended to Coordinate with Paint Color | | | |
|---|------------|----------------|-------------|
| Paint Color | Paint Code | Duplex Color | Duplex Code |
| Black | P | Black | P |
| Brownstone | P7D | Brownstone | EY |
| Charcoal | S | Charcoal | S |
| Designer White | PJW | Designer White | DW |
| Fossil | P28 | Charcoal | S |
| Greige | T5 | Muslin | T3 |
| Light Gray | Q | Loft | LOFT |
| Loft | LOFT | Loft | LOFT |
| Muslin | T3 | Muslin | T3 |
| Putty | L | Black | P |
| Shadow | SHDW | Muslin | T3 |
| Silver | PR6 | Titanium | TI |
| Titanium | P8T | Titanium | TI |
| Champagne Metallic | T4 | Muslin | T3 |
| Platinum Metallic | T1 | Titanium | TI |

| Data / Electrical Port Kit Color Recommended to Coordinate with Paint Color | | | |
|---|------------|-----------------------|----------------------|
| Paint Color | Paint Code | Data / Port Kit Color | Data / Port Kit Code |
| Black | P | Black | P |
| Brownstone | P7D | Brownstone | EY |
| Charcoal | S | Charcoal | S |
| Designer White | PJW | Designer White | DW |
| Fossil | P28 | Charcoal | S |
| Greige | T5 | Muslin | T3 |
| Light Gray | Q | Loft | LOFT |
| Loft | LOFT | Loft | LOFT |
| Muslin | T3 | Muslin | T3 |
| Putty | L | Black | P |
| Shadow | SHDW | Muslin | T2 |
| Silver | PR6 | Titanium | TI |
| Titanium | P8T | Titanium | TI |
| Champagne Metallic | T4 | Muslin | T3 |
| Platinum Metallic | T1 | Titanium | TI |

HOW TO SPECIFY

| | |
|--|--|
| <p>Select Model Number</p> <p>HH873501 .</p> | <p>Select Color</p> <p>P</p> <p>See page 481</p> |
|--|--|

SYSTEMS

Electrical Components

GSA SIN 33721 EXCEPT AS NOTED

ABI

Icon Legend on page 19

WORKSTATIONS

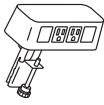

DESCRIPTION

Power & Data Center

2 Receptacles 2 Data Accessory

- Standard with two receptacles and openings for two data ports.
- 6' power cord with standard three-prong plug.
- Fits on any worksurface with a 4" overhang.
- UL Listed.

NOTES: Cable ports accommodate up to four individual voice and data outlets, and can be mounted anywhere there is an electrical receptacle opening. Data/Electrical Port Kit used for field installations of additional data accessories.

- ! Four-circuit components and three-circuit components (with "A" suffix) not designed to be used together. See pages 603-604.
- ! Duplex receptacle models shown on the previous page are for use with Abound® models only.
- ! Color finish coordinates with HON's Loft. *Specify LOFT when ordering. Example: HCOMDOME2.LOFT*

MODEL

HCOMDOME2

SHIP WEIGHT

2.5

CUBE

0.2

LIST PRICE

\$327

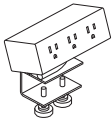

Model HPWRMOD3WC shown

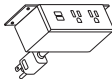

Model HPWRMOD2UWM shown

Power Modules

3 Receptacles with Worksurface Clamp

3 Receptacles with Under-Worksurface Mounting Bracket

2 Receptacles 2 USB with Worksurface Clamp

2 Receptacles 2 USB with Under-Worksurface Mounting Bracket

- 6' power cord with standard three-prong plug.
- Under-worksurface mounting bracket models work with any top that has a 5" x 5" square clearance.
- Worksurface clamp models work on any top with a 4" overhang.
- UL Listed.

NOTES: Cable ports accommodate up to four individual voice and data outlets, and can be mounted anywhere there is an electrical receptacle opening. Data/Electrical Port Kit used for field installations of additional data accessories.

- ! Four-circuit components and three-circuit components (with "A" suffix) not designed to be used together. See pages 603-604.
- ! Duplex receptacle models shown on the previous page are for use with Abound® models only.
- ! Color finish coordinates with HON's Charcoal or White. *Specify STRM for Storm and SNW for Snow when ordering. Example: HPWRMOD3WC.STRM*

HPWRMOD3WC

2.3

0.2

\$342

HPWRMOD3UWM

2.3

0.2

\$342

HPWRMOD2WC

2.3

0.2

\$546

HPWRMOD2UWM

2.3

0.2

\$546



Vertebrae

NOTES: 30"H x 3 1/8"W x 1 1/2"D. Ships unassembled.

- ! Clear finish. Specify "X" for finish option.
- SPECIFYING EXAMPLE: HMPVWM28.X**

HMPVWM28

3.0

0.3

\$246

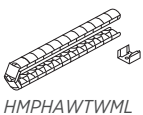

HMPHAWTWML



HMPHATFWML

Wire Managers for Height Adjustable

Workstation to Trough

Trough to Floor

- ! Wire Manager Workstation to Trough only available in black.
- ! HMPHATFWML Trough to Floor cable manager is 3" x 1 1/2".

HMPHAWTWML

3.0

0.1

\$295

HMPHATFWML

2.0

0.3

\$269

OPEN MARKET

NOTES:

- For additional information see the Workplace Tools section in the 2021 Shared Spaces Pricer.

HOW TO SPECIFY







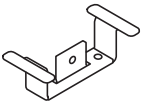
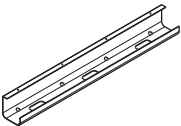
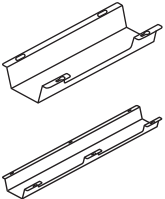
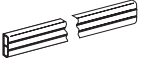

Select Model Number

H C O M D O M E 2 .

Select Color

See page 481

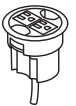
L O F T

| | DESCRIPTION | MODEL | SHIP WEIGHT | CUBE | LIST PRICE |
|---|--|--|--|--------------------------|--|
|  | Abound Electrical Mounting Brackets (pack of 12) 1 bracket required at beltline for each pass-thru harness and 24"W power harness and 2 for 30"-60"W power harness. Bracket for use at beltline only. Dimension of raceway mounting bracket is different and not interchangeable. Bracket height for beltline changed Q1 2019. If adding onto product produced prior to Q1 2019, please contact HON Customer Support. | HH8988EBN | 3.0 \$ | 0.1 | \$70 |
|  | Cable Management Tray 24" 36" | HHCMT24 HHCMT36 | 2.0 \$ 3.0 \$ | 0.3 0.4 | \$82 \$101 |
| Black only | | | | | |
|  | Cable Management Troughs 17"W – Single 17"W – 10-Pack 36"W – Single 36"W – 10-Pack Cable management troughs ship flat packed. The troughs attach to underneath the worksurface with screws. The 17"W has one wire access cut out on the user side. The 36" has two wire access cut outs. These cut outs give users access to inside the trough without having to detach it from the worksurface. Color: Graphite. Material: Metal. TAA Compliant. Slim profile design. | HCTROUGH17 HCTROUGH1710 HCTROUGH36 HCTROUGH3610 | 2.7 \$ 14.0 \$ 4.9 \$ 30.0 \$ | 0.5 0.5 0.9 0.9 | \$73 \$665 \$122 \$1121 |
| | NOTES: For additional information see the Workplace Tools section in the 2021 Shared Spaces Pricer. | | | | |
|  | Wire Manager HHEM model clips to bottom of panels. (62"W) Slits in wire manager allows cable to be passed into unit. | HHEM620 | 10.0 \$ | 0.5 | \$115 |
| Black only | | | | | |
|  | AMP Data Faceplates Three-port flex-mode faceplate Four-port flex-mode faceplate | HHTADF3  HHTADF4  | 1.0 \$ 1.0 \$ | 0.2 0.2 | \$29 \$29 |
|  | AMP RJ45 CAT 5E Jack – Black (P) AMP RJ45 CAT 6 Jack – Black (P) | HHTADJ5  HHTADJ6  | 1.0 \$ 1.0 \$ | 0.1 0.1 | \$46 \$62 |
| Black only | Models HHTADJ5 and HHTADJ6 snap into faceplate. NOTES: AMP Data Faceplates attach to bottom of panel or at worksurface height in front of baserail covers for easy cable routing. Faceplates cannot be installed back-to-back in a panel application. | | | | |
|  | Power Hub, 3" Grommet Mount, 6' Cord Fits in 3" round grommet holes on the following product lines: Coordinate, Huddle, Motivate, all laminate and veneer casegoods series, and Systems Worksurfaces. Two grounded AC power outlets. Includes 6' cord with three-prong plug. Field installed with Plug-and-play ease. | HGRMTAC | 1.3 | 0.2 | \$126 |
| SIN 33721T | NOTES: For additional information see the Workplace Tools section in the 2021 Shared Spaces Pricer. Available in black only (no color designation so use .X – Specify: HGRMTAC.X). | | | | |
|  | Power/USB Hub, 3" Grommet Mount One grounded AC power outlet with 2 USB ports. UL Listed. | HGRMTUSB2 | 1.3 \$ | 0.2 | \$250 |
| SIN 33721T | NOTES: For additional information see the Workplace Tools section in the 2021 Shared Spaces Pricer. Available in black only (no color designation so use .X – Specify: HGRMTUSB2.X). | | | | |

SYSTEMS

Working with Worksurfaces and Supports

Worksurfaces are 1½" thick with particle-board core and with top surfaces finished in high-pressure laminate. Bottom surfaces are covered with a backer sheet.

Worksurface bracket kits support worksurface by attaching to an adjacent return panel the same width as the worksurface depth. Brackets allow one end of a worksurface to be supported by a panel return.



Cantilever brackets can be inserted into panel reveals in 1" vertical increments. Left or right handed. One size is used for both 24"D and 30"D worksurfaces. 18" Cantilever brackets are used for 18"D worksurfaces. DO NOT USE cantilever brackets at the end of a worksurface where no return panel is positioned or in worksurface runs longer than 72"W.

Wire management grommets are standard in most worksurfaces (unless "no grommet" worksurfaces selected).

Corner worksurfaces optimize use of space, and provide a convenient location for computer and monitor.

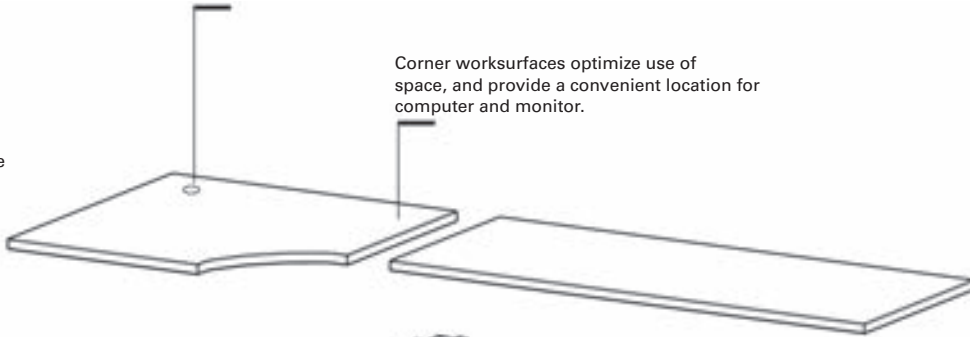

Flat brackets can be used to connect one worksurface perpendicular to another worksurface.

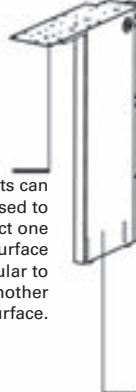

End-panel supports are used at the end of a run when no return panel is present. Straight worksurfaces adjacent to 120° connections must be supported by full end panels. Leveling glides provide 2¾" of adjustment.



Support legs are used to support worksurfaces only in a shared position.

Primary worksurfaces are available in 18", 24" and 30" depths. Nominal worksurface width is equal to nominal panel width. Other support hardware is ordered separately.

Corner worksurfaces with woodgrain laminate have grain direction diagonal to adjacent worksurfaces. One rear center support bracket is included. All other support hardware is ordered separately.

Wire management grommets are standard in most worksurfaces. Worksurfaces less than 48"W have one grommet centered on edge of worksurface. Rectangular worksurfaces over 42"W have two grommets. Peninsulas have one grommet. Corner Worksurfaces have one grommet (one on each back edge). D-Shaped worksurfaces and countertops do not have grommets.

Edgeband is available on laminate tops in standard colors (customer specified) to match or complement solid, patterned, or woodgrain laminates.

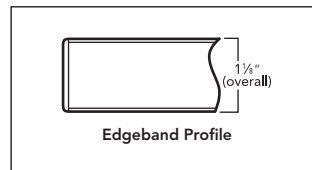

Working with Worksurfaces and Supports

Optional width worksurfaces are available for use with panel runs having a TEE or Extended Straight connection.

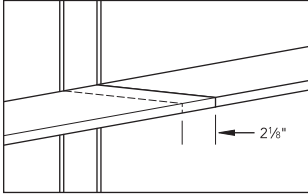

Worksurfaces can be configured at 29 1/2" with end-panel supports and support legs, or at various heights on 1" increments using specific product configurations.

Worksurface support options include:

- Open leg models
- Support column
- Flat brackets
- Worksurface bracket kit
- Cantilever bracket
- Universal support leg
- End-panel support
- Freestanding pedestal

Other worksurface supports include:

- Support columns
- External channel supports
- Support pedestals
- Pedestals with panel-to-pedestal bracket
- Desking freestanding shared leg

Support Guidelines:

- Unsupported panel runs greater than 72"W need floor support for improved stability.
- Worksurface bracket kit should be used to tie panels to worksurfaces for added stability.
- A panel run without a return needs a floor support.
- Unsupported worksurface spans of 60"W-84"W require an external worksurface support channel. It is recommended for 48"W-60"W.
- Cantilevers only to be used on worksurface runs 48"W or less.

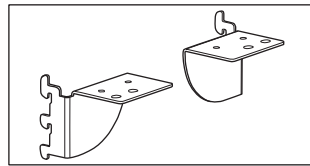

Worksurface bracket kit allows one end of a worksurface to be supported by a return panel. Return panel width must be the same as the depth of the worksurface.

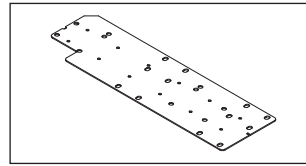

Flat brackets can be used to connect one worksurface perpendicular to another worksurface.

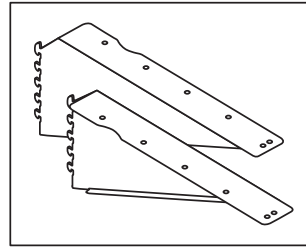

Cantilever brackets are left or right handed. They can be inserted into panel reveals in 1" vertical increments. One size is used for both 24" and 30"D worksurfaces. 18" Cantilever brackets are used for 18"D worksurfaces. Both left and right brackets are required in shared applications.

Important: Do not use cantilever brackets at the end of a worksurface where no 90° return panel is positioned.

- Do not use to support worksurfaces from which a hanging pedestal is suspended, or which a peninsula worksurface is attached.
- Do not use to support worksurfaces supported with permanent wall hanger kit.

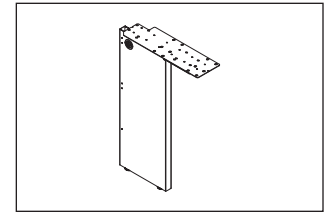

Universal support legs are used to support worksurfaces only in a shared position.

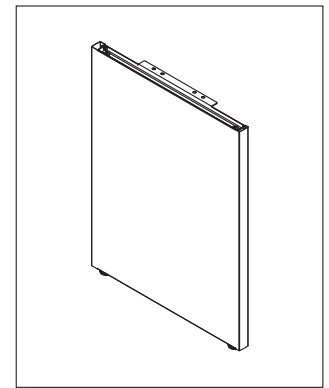

End-panel supports are used in place of return panels at the end of worksurface runs. Straight worksurfaces adjacent to 120° connections must be supported by full end panels. End-panel supports are ordered for right- or left-handed application. Leveling glides provide 1/2" of adjustment.

SYSTEMS

Working with Worksurfaces and Supports

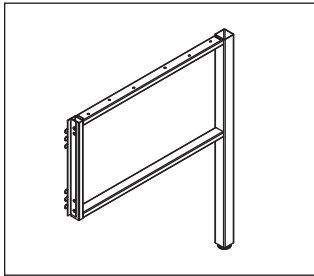

Open Leg models are used to support various worksurface configurations and include attaching hardware and leveling glides.

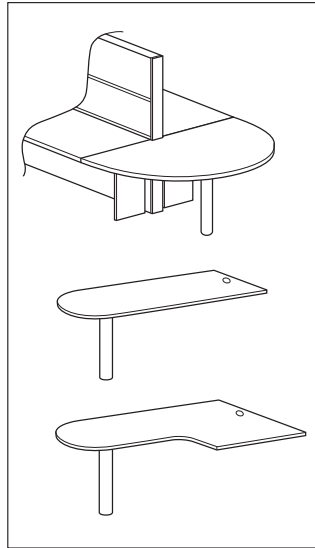

D-Shaped, Peninsula and Jetty worksurfaces require support columns (ordered separately).

Countertops are available in straight or corner configurations.

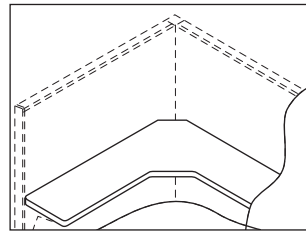

Corner shelves are available in Edgeband. Attachment brackets are included.

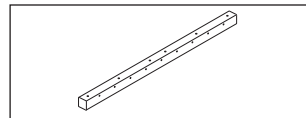

- Unsupported worksurface spans of 60"W-84"W require an external worksurface support channel. It is recommended for 48"W-60"W.

EXTERNAL CHANNEL SELECTION GUIDE

| Support Combination | | Rectangle Worksurface Width | | | |
|---------------------------|---------------------------|-----------------------------|-----|----------|-----|
| | | Recommended | | Required | |
| Worksurface End Support 1 | Worksurface End Support 2 | 54 | 60 | 66 | 72 |
| End Panel | End Panel | 42" | 48" | 54" | 60" |
| End Panel | Pedestal | NA | NA | NA | 42" |
| End Panel | Worksurface Brackets | 42" | 48" | 54" | 60" |
| End Panel | Cantilever | 42" | 48" | 54" | 60" |
| End Panel | Open Leg | 42" | 48" | 54" | 60" |
| Pedestal | Pedestal | NA | NA | NA | NA |
| Pedestal | Worksurface Brackets | NA | NA | NA | 42" |
| Pedestal | Cantilever | NA | NA | NA | 42" |
| Pedestal | Open Leg | NA | NA | NA | 42" |
| Worksurface Brackets | Worksurface Brackets | 42" | 48" | 54" | 60" |
| Worksurface Brackets | Cantilever | 42" | 48" | 54" | 60" |
| Worksurface Brackets | Open Leg | 42" | 48" | 54" | 60" |

See page 198 for External Channel models.

Supports above are recommended for worksurfaces 54"W or 60"W. For 66"-72" worksurfaces, the supports are required.



SYSTEMS WORKSURFACES

Primary

| DESCRIPTION | MODEL | SHIP WEIGHT | CUBE | L1 | L2 |
|---|------------|-------------|------|------------|------------|
| | | | | LIST PRICE | LIST PRICE |
| Primary and/or Return Worksurfaces | | | | | |
| 24"W x 18"D | HWR1824P | 23 | 2.1 | \$330 | \$340 |
| 30"W x 18"D | HWR1830P | 28 | 2.1 | \$342 | \$352 |
| 36"W x 18"D | HWR1836P | 35 | 2.5 | \$355 | \$365 |
| 42"W x 18"D | HWR1842P | 39 | 2.8 | \$366 | \$376 |
| 48"W x 18"D | HWR1848P | 44 | 3.2 | \$405 | \$415 |
| 54"W x 18"D | HWR1854P | 48 | 4.0 | \$451 | \$466 |
| 60"W x 18"D | HWR1860P | 53 | 4.0 | \$463 | \$478 |
| 66"W x 18"D | HWR1866P | 65 | 4.7 | \$497 | \$512 |
| 72"W x 18"D | HWR1872P | 67 | 4.7 | \$509 | \$524 |
| | | | | | |
| 24"W x 24"D | HWR2424P | 31 | 2.2 | \$338 | \$348 |
| 30"W x 24"D | HWR2430P ☉ | 37 | 2.2 | \$353 | \$363 |
| 36"W x 24"D | HWR2436P ☉ | 46 | 2.5 | \$382 | \$397 |
| 42"W x 24"D | HWR2442P | 52 | 2.5 | \$419 | \$434 |
| 48"W x 24"D | HWR2448P ☉ | 58 | 3.3 | \$446 | \$461 |
| 54"W x 24"D | HWR2454P | 64 | 4.0 | \$473 | \$493 |
| 60"W x 24"D | HWR2460P ☉ | 70 | 4.0 | \$526 | \$546 |
| 66"W x 24"D | HWR2466P | 86 | 4.8 | \$565 | \$585 |
| 72"W x 24"D | HWR2472P ☉ | 89 | 4.8 | \$583 | \$603 |
| 84"W x 24"D | HWR2484P | 103 | 5.1 | \$826 | \$851 |

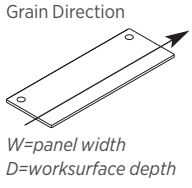

NOTES:

- Worksurfaces may be used with Accelerate®, Abound® and Voi® products.
- Worksurfaces are constructed of laminate on 1/8" solid core high-performance particleboard.
- Models up to 42"W are standard with one centered grommet. Models 48"W and wider are standard with two grommets.
- Accelerate® adds a "C" prefix and "T" suffix and Abound® adds a "B" prefix and "T" suffix to the Model Number for primary worksurfaces to span a TEE or EXTENDED STRAIGHT connection (adds 2 1/4" to width). Add upcharge of \$30 List per model.
- Add suffix "N" to Model Number for worksurfaces with no grommets. No upcharge.
- Woodgrain runs horizontally across surface.
- ! 18"D models are not available in Tee-Span but can be accommodated through Tailored Solutions.
- ! EXTENDED STRAIGHT worksurfaces are available with grommets only.
- ! 60"W, 66"W and 72"W worksurfaces require one or more of the following: worksurface support brackets, end panel, external channel universal support leg or pedestal support in conjunction with cantilever brackets.
- ! When a run of worksurfaces equals or exceeds 6 feet, a floor support is required for worksurface structural assurance.
- ! All worksurfaces load tested to BIFMA standards.

HOW TO SPECIFY

| | | | |
|---|---|---|--|
| <p>Select Model Number</p> <p>For Tee-Span or Extended straight connection: Accelerate® adds a "C" prefix and "T" suffix (\$30 upcharge per model)</p> <p>Abound® adds a "B" prefix and "T" suffix (\$30 upcharge per model)</p> <p>No Grommet option: Add "N" suffix (no upcharge)</p> <p>HWR2424P .</p> <p>HCWR2424PT .</p> <p>HBWR2424PT .</p> <p>HWR2424PN .</p> | <p>Select Laminate</p> <p>See page 481</p> <p>A5 .</p> <p>A5 .</p> <p>A5 .</p> <p>A5 .</p> | <p>Select Edge Color</p> <p>See page 481</p> <p>K .</p> <p>K .</p> <p>K .</p> <p>K .</p> | <p>Select Grommet Color</p> <p>See page 481</p> <p>T1</p> <p>T1</p> <p>T1</p> |
|---|---|---|--|

SYSTEMS WORKSURFACES

Primary

GSA SIN 33721



Icon Legend on page 19

WORKSTATIONS

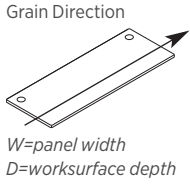

DESCRIPTION

Primary and/or Return Worksurfaces

24"W x 30"D
30"W x 30"D
36"W x 30"D
42"W x 30"D
48"W x 30"D
54"W x 30"D
60"W x 30"D
66"W x 30"D
72"W x 30"D
84"W x 30"D

MODEL

HWR3024P
HWR3030P
HWR3036P
HWR3042P
HWR3048P
HWR3054P
HWR3060P ☉
HWR3066P
HWR3072P ☉
HWR3084P

SHIP WEIGHT

47
56
62
64
68
80
101
105
105
127

CUBE

2.2
2.6
3.1
3.6
4.0
5.0
5.0
6.0
6.0
6.2

L1 LIST PRICE

\$353
\$405
\$429
\$456
\$481
\$517
\$573
\$612
\$653
\$881

L2 LIST PRICE

\$365
\$417
\$444
\$471
\$496
\$537
\$593
\$632
\$673
\$906

NOTES:

- Worksurfaces may be used with Accelerate®, Abound® and Voi® products.
- Worksurfaces are constructed of laminate on 1½" solid core high-performance particleboard.
- Models up to 42"W are standard with one centered grommet. Models 48"W and wider are standard with two grommets.
- Accelerate® adds a "C" prefix and "T" suffix and Abound® adds a "B" prefix and "T" suffix to the Model Number for primary worksurfaces to span a TEE or EXTENDED STRAIGHT connection (adds 2¼" to width). Add upcharge of \$30 List per model.
- Add suffix "N" to Model Number for worksurfaces with no grommets. No upcharge.
- Woodgrain runs horizontally across surface.

- ! EXTENDED STRAIGHT worksurfaces are available with grommets only.
- ! 60"W, 66"W, 72"W, and 84"W worksurfaces require one or more of the following: worksurface support brackets, end panel, external channel universal support leg or pedestal support in conjunction with cantilever brackets.
- ! When a run of worksurfaces equals or exceeds 6 feet, a floor support is required for worksurface structural assurance.
- ! All worksurfaces load tested to BIFMA standards.

EXTERNAL CHANNEL SELECTION GUIDE

| Support Combination | | Rectangle Worksurface Width | | | | |
|---------------------------|---------------------------|-----------------------------|-----|-----|-----|-----|
| Worksurface End Support 1 | Worksurface End Support 2 | 54 | 60 | 66 | 72 | 84 |
| End Panel | End Panel | 42" | 48" | 54" | 60" | 72" |
| End Panel | Pedestal | NA | NA | NA | 42" | 48" |
| End Panel | Worksurface Brackets | 42" | 48" | 54" | 60" | 72" |
| End Panel | Cantilever | 42" | 48" | 54" | 60" | 72" |
| End Panel | Open Leg | 42" | 48" | 54" | 60" | 72" |
| Pedestal | Pedestal | NA | NA | NA | NA | NA |
| Pedestal | Worksurface Brackets | NA | NA | NA | 42" | 48" |
| Pedestal | Cantilever | NA | NA | NA | 42" | 48" |
| Pedestal | Open Leg | NA | NA | NA | 42" | 48" |
| Worksurface Brackets | Worksurface Brackets | 42" | 48" | 54" | 60" | 72" |
| Worksurface Brackets | Cantilever | 42" | 48" | 54" | 60" | 72" |
| Worksurface Brackets | Open Leg | 42" | 48" | 54" | 60" | 72" |

See page 198 for External Channel models.

HOW TO SPECIFY

Select Model Number

For Tee-Span or Extended straight connection: Accelerate® adds a "C" prefix and "T" suffix (\$30 upcharge per model)

Abound® adds a "B" prefix and "T" suffix (\$30 upcharge per model)

No Grommet option: Add "N" suffix (no upcharge)

HWR3024P .

HCWR3024PT .

HBWR3024PT .

HWR3024PN .

Select Laminate

See page 481

A5 .

A5 .

A5 .

A5 .

Select Edge Color

See page 481

K .

K .

K .

K .

Select Grommet Color

See page 481

T1

T1

T1



SYSTEMS WORKSURFACES

Wedge

| | DESCRIPTION | MODEL | SHIP WEIGHT | CUBE | L1 LIST PRICE | L2 LIST PRICE |
|--|---------------------------|-------------------|-------------|------|---------------|---------------|
| | Wedge Worksurfaces | | | | | |
| | 48" A x 24" B x 30" C | HWD244830P | 64 | 4.8 | \$612 | \$627 |
| | 54" A x 24" B x 30" C | HWD245430P | 80 | 4.8 | \$657 | \$677 |
| | 60" A x 24" B x 30" C | HWD246030P | 101 | 4.8 | \$703 | \$723 |
| | 66" A x 24" B x 30" C | HWD246630P | 105 | 5.7 | \$748 | \$768 |
| | 72" A x 24" B x 30" C | HWD247230P | 109 | 5.7 | \$798 | \$818 |
| | Wedge Worksurfaces | | | | | |
| | 48" A x 30" B x 24" C | HWD304824P | 64 | 4.8 | \$612 | \$627 |
| | 54" A x 30" B x 24" C | HWD305424P | 80 | 4.8 | \$657 | \$677 |
| | 60" A x 30" B x 24" C | HWD306024P | 101 | 4.8 | \$703 | \$723 |
| | 66" A x 30" B x 24" C | HWD306624P | 105 | 5.7 | \$748 | \$768 |
| | 72" A x 30" B x 24" C | HWD307224P | 109 | 5.7 | \$798 | \$818 |

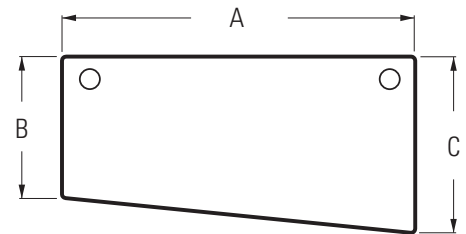
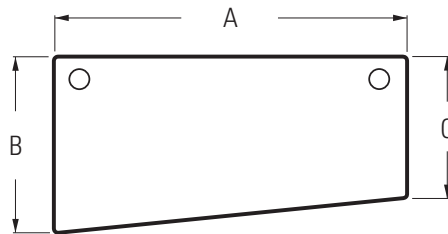

See matrix on page 618.

NOTES:

- Worksurfaces may be used with Accelerate®, Abound® and Voi® products.
 - Worksurfaces are constructed of laminate on 1½" solid core particleboard.
 - Refer to Worksurface Supports, pages 630-634.
 - Universal support leg can be used to share support when worksurfaces are placed side-by-side.
 - Add suffix "N" to Model Number for worksurfaces with no grommets. No upcharge.
 - Woodgrain runs horizontally across surface.
- ❗ 60"W, 66"W and 72"W worksurfaces require one or more of the following: worksurface support brackets, end panel, external channel universal support leg or pedestal support in conjunction with cantilever brackets. A full end panel can also be used for support in place of cantilever brackets.
- ❗ When a run of worksurfaces equals or exceeds 6 feet, a floor support is required for worksurface structural assurance.

HOW TO SPECIFY

| | | | |
|---|---|---|--|
| <p>Select Model Number</p> <p>No Grommet option: Add "N" suffix (no upcharge)</p> <p>HWD244830P .</p> <p>HWD244830PN .</p> | <p>Select Laminate</p> <p>See page 481</p> <p>A5 .</p> <p>A5 .</p> | <p>Select Edge Color</p> <p>See page 481</p> <p>K .</p> <p>K .</p> | <p>Select Grommet Color</p> <p>See page 481</p> <p>T1</p> |
|---|---|---|--|

SYSTEMS WORKSURFACES

Corner

GSA SIN 33721



Icon Legend on page 19

WORKSTATIONS

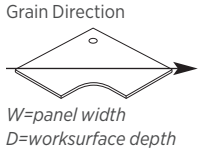

DESCRIPTION

Corner Worksurfaces with Curved User Edge

- 36"W x 24"D
- 42"W x 24"D
- 48"W x 24"D
- 42"W x 30"D
- 48"W x 30"D

MODEL

- HWC3624P**
- HWC4224P**
- HWC4824P**
- HWC4230P**
- HWC4830P**

SHIP WEIGHT

- 53
- 65
- 76
- 72
- 77

CUBE

- 3.7
- 4.9
- 6.3
- 6.3
- 6.3

L1 LIST PRICE

- \$597**
- \$631**
- \$710**
- \$741**
- \$800**

L2 LIST PRICE

- \$612**
- \$646**
- \$725**
- \$756**
- \$815**

- HWC3624P will not accept the H4022, H4028, or H4029 keyboard platforms.
- One small worksurface bracket standard with each worksurface.

! Corner worksurfaces must match exactly the panel behind them, i.e.: a 36" panel must be used on the back two sides of model HWC3624P.

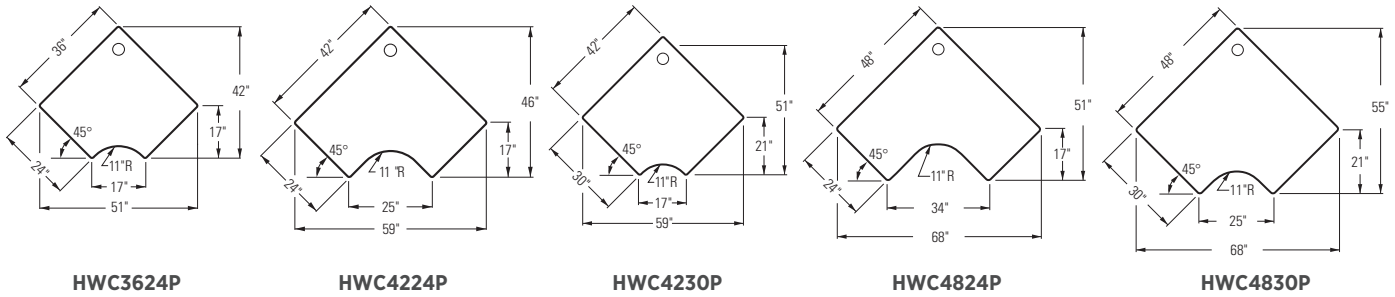

NOTES:

- Worksurfaces may be used with Accelerate®, Abound® and Voi® products.
- Add suffix **"N"** to Model Number for worksurfaces with no grommets. No upcharge.
- Worksurfaces are constructed of laminate on 1½" solid core high-performance particleboard.
- Refer to Worksurface Supports, pages 630-634.

HOW TO SPECIFY

| | | | |
|--|---|---|--|
| <p>Select Model Number</p> <p>No Grommet option: Add "N" suffix (no upcharge)</p> <p>HWC3624P .</p> <p>HWC3624PN .</p> | <p>Select Laminate</p> <p>See page 481</p> <p>AS .</p> <p>AS .</p> | <p>Select Edge Color</p> <p>See page 481</p> <p>K .</p> <p>K .</p> | <p>Select Grommet Color</p> <p>See page 481</p> <p>T1</p> |
|--|---|---|--|



SYSTEMS WORKSURFACES

Corner

Grain Direction

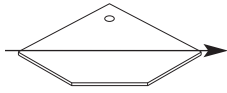

W=panel width
D=worksurface depth

DESCRIPTION

Corner Worksurfaces with Straight User Edge

- 36"W x 24"D
- 42"W x 24"D
- 48"W x 24"D
- 42"W x 30"D
- 48"W x 30"D

MODEL

- HWCS3624P**
- HWCS4224P**
- HWCS4824P**
- HWCS4230P**
- HWCS4830P**

SHIP WEIGHT

- 53
- 65
- 76
- 72
- 77

CUBE

- 3.7
- 4.9
- 6.3
- 6.3
- 6.3

L1 LIST PRICE

- \$575**
- \$602**
- \$664**
- \$723**
- \$736**

L2 LIST PRICE

- \$590**
- \$617**
- \$679**
- \$738**
- \$751**

- HWCS3624P will not accept the H4022, H4028, or H4029 keyboard platforms.
- One small worksurface bracket standard with each worksurface.

! Corner worksurfaces must match exactly the panel behind them, i.e.: a 36" panel must be used on the back two sides of model HWCS3624P.

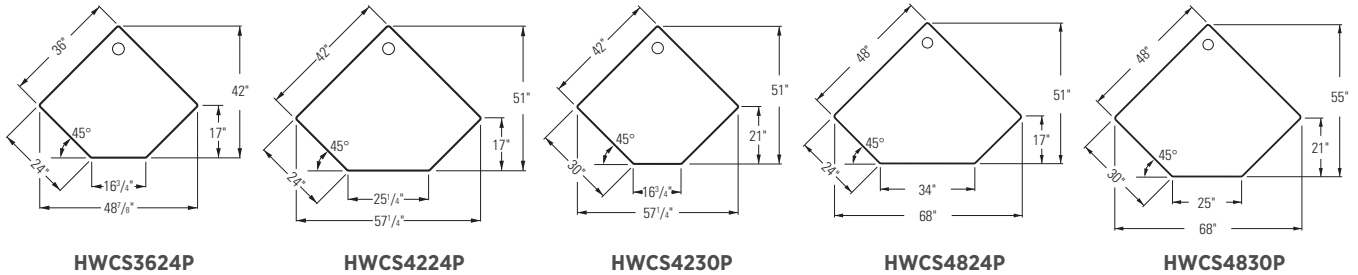

NOTES:

- Worksurfaces may be used with Accelerate®, Abound® and Voi® products.
- Add suffix **"N"** to Model Number for worksurfaces with no grommets. No upcharge.
- Worksurfaces are constructed of laminate on 1/8" solid core high-performance particleboard.
- Refer to Worksurface Supports, pages 630-634.

HOW TO SPECIFY

| | | | |
|--|---|---|--|
| <p>Select Model Number</p> <p>No Grommet option: Add "N" suffix (no upcharge)</p> <p>HWCS3624P .</p> <p>HWCS3624PN .</p> | <p>Select Laminate</p> <p>See page 481</p> <p>AS .</p> <p>AS .</p> | <p>Select Edge Color</p> <p>See page 481</p> <p>K .</p> <p>K .</p> | <p>Select Grommet Color</p> <p>See page 481</p> <p>T1</p> |
|--|---|---|--|

SYSTEMS WORKSURFACES

120 Degree Corner

GSA SIN 33721



Icon Legend on page 19

WORKSTATIONS

Grain Direction

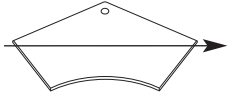

W=panel width

D=worksurface depth

DESCRIPTION

Abound® and Accelerate® 120 Degree Corner Worksurfaces with Curved User Edge

36"W x 24"D

42"W x 24"D

48"W x 24"D

42"W x 30"D

48"W x 30"D

- HBWCT3624P will not accept the H4022, HE4022, H4028, or H4029 keyboard platforms.
- One small work surface bracket standard with each work surface.

❗ Corner work surfaces must match exactly the panel behind them, i.e.: a 36" panel must be used on the back two sides of model HBWCT3624P.

MODEL

HBWCT3624P

HBWCT4224P

HBWCT4824P

HBWCT4230P

HBWCT4830P

SHIP WEIGHT

75

96

107

102

112

CUBE

7.7

9.2

9.2

11.4

11.4

L1 LIST PRICE

\$856

\$917

\$1063

\$1205

\$1282

L2 LIST PRICE

\$871

\$932

\$1078

\$1220

\$1297

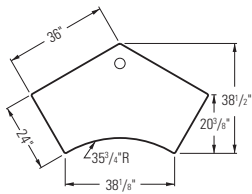

HBWCT3624P

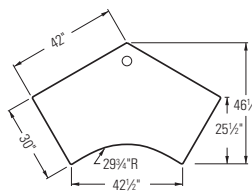

HBWCT4230P

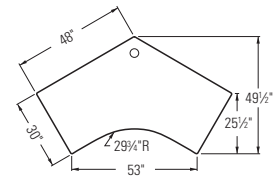

HBWCT4830P

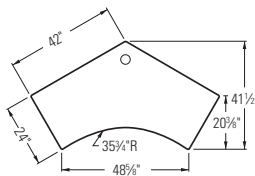

HBWCT4224P

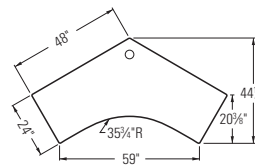

HBWCT4824P

NOTES:

- Worksurfaces are constructed of laminate on 1/8" solid core high-performance particleboard.
- Add suffix "N" to Model Number for worksurfaces with no grommets. No upcharge.
- Refer to Worksurface Supports, pages 630-634.
- If used at an end of run, full end panel needs to be ordered — see page 630.

HOW TO SPECIFY

Select Model Number

No Grommet option: Add "N" suffix (no upcharge)

HBWCT3624P

HBWCT3624PN

Select Laminate

See page 481

AS

AS

Select Edge Color

See page 481

K

K

Select Grommet Color

See page 481

T1



SYSTEMS WORKSURFACES

Corner Cove

Grain Direction

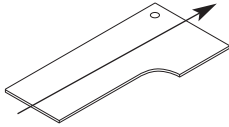

DESCRIPTION

Corner Cove Worksurfaces, Left Hand

60" A x 36" B x 24" C x 24" D
60" A x 36" B x 30" C x 24" D

60" A x 48" B x 24" C x 24" D
60" A x 48" B x 24" C x 30" D
60" A x 48" B x 30" C x 24" D
60" A x 48" B x 30" C x 30" D

72" A x 36" B x 24" C x 24" D
72" A x 36" B x 30" C x 24" D

72" A x 48" B x 24" C x 24" D
72" A x 48" B x 24" C x 30" D
72" A x 48" B x 30" C x 24" D
72" A x 48" B x 30" C x 30" D

| MODEL | SHIP WEIGHT | CUBE | L1 LIST PRICE | L2 LIST PRICE |
|------------------|-------------|------|---------------|---------------|
| HWV73AALP | 67 | 5.9 | \$673 | \$698 |
| HWV73BALP | 76 | 5.9 | \$695 | \$720 |
| HWV75AALP | 85 | 7.7 | \$736 | \$766 |
| HWV75ABLP | 94 | 7.7 | \$762 | \$792 |
| HWV75BALP | 92 | 7.7 | \$762 | \$792 |
| HWV75BBLP | 99 | 7.7 | \$790 | \$820 |
| HWV93AALP | 75 | 7.0 | \$736 | \$766 |
| HWV93BALP | 83 | 7.0 | \$762 | \$792 |
| HWV95AALP | 96 | 9.2 | \$918 | \$953 |
| HWV95ABLP | 107 | 9.2 | \$944 | \$979 |
| HWV95BALP | 102 | 9.2 | \$944 | \$979 |
| HWV95BBLP | 112 | 9.2 | \$974 | \$1009 |

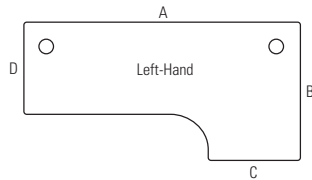

NOTES:

- Worksurfaces may be used with Accelerate®, Abound® and Voi® products.
- Worksurfaces are constructed of laminate on 1/8" solid core high-performance particleboard.
- Includes a rear-support bracket in Charcoal only.
- Add suffix **"N"** to Model Number for worksurfaces with no grommets. No upcharge.
- Refer to Worksurface Supports, pages 630-634.
- ❗ Panel-hung application requires two panels of corresponding width joined at 90°.
- ❗ When a run of worksurfaces equals or exceeds 6 feet, a floor support is required for worksurface structural assurance.
- ❗ 60"W, 66"W and 72"W worksurfaces require one or more of the following: worksurface support brackets, end panel, external channel universal support leg or pedestal support in conjunction with cantilever brackets.

HOW TO SPECIFY

| | | | |
|--|---|---|--|
| <p>Select Model Number</p> <p>No Grommet option: Add "N" suffix (no upcharge)</p> <p>HWV73AALP .</p> <p>HWV73AALPN .</p> | <p>Select Laminate</p> <p>See page 481</p> <p>AS .</p> <p>AS .</p> | <p>Select Edge Color</p> <p>See page 481</p> <p>K .</p> <p>K .</p> | <p>Select Grommet Color</p> <p>See page 481</p> <p>T1</p> |
|--|---|---|--|

SYSTEMS WORKSURFACES

Corner Cove

GSA SIN 33721



Icon Legend on page 19

WORKSTATIONS

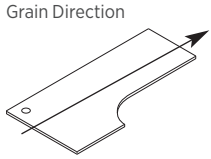

| DESCRIPTION | MODEL | SHIP WEIGHT | CUBE | L1 LIST PRICE | L2 LIST PRICE |
|---|------------------|-------------|------|---------------|---------------|
| Corner Cove Worksurfaces, Right Hand | | | | | |
| 60" A x 36" B x 24" C x 24" D | HWV73AARP | 67 | 5.9 | \$673 | \$698 |
| 60" A x 36" B x 30" C x 24" D | HWV73BARP | 76 | 5.9 | \$695 | \$720 |
| 60" A x 48" B x 24" C x 24" D | HWV75AARP | 85 | 7.7 | \$736 | \$766 |
| 60" A x 48" B x 24" C x 30" D | HWV75ABRP | 94 | 7.7 | \$762 | \$792 |
| 60" A x 48" B x 30" C x 24" D | HWV75BARP | 92 | 7.7 | \$762 | \$792 |
| 60" A x 48" B x 30" C x 30" D | HWV75BBRP | 99 | 7.7 | \$790 | \$820 |
| 72" A x 36" B x 24" C x 24" D | HWV93AARP | 75 | 7.0 | \$736 | \$766 |
| 72" A x 36" B x 30" C x 24" D | HWV93BARP | 83 | 7.0 | \$762 | \$792 |
| 72" A x 48" B x 24" C x 24" D | HWV95AARP | 96 | 9.2 | \$918 | \$953 |
| 72" A x 48" B x 24" C x 30" D | HWV95ABRP | 107 | 9.2 | \$944 | \$979 |
| 72" A x 48" B x 30" C x 24" D | HWV95BARP | 102 | 9.2 | \$944 | \$979 |
| 72" A x 48" B x 30" C x 30" D | HWV95BBRP | 112 | 9.2 | \$974 | \$1009 |

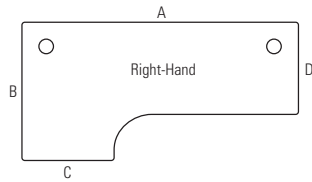

NOTES:

- Worksurfaces may be used with Accelerate®, Abound® and Voi® products.
- Worksurfaces are constructed of laminate on 1/8" solid core high-performance particleboard.
- Includes a rear-support bracket in Charcoal only.
- Add suffix **"N"** to Model Number for worksurfaces with no grommets. No upcharge.
- Refer to Worksurface Supports, pages 630-634.
- ! Panel-hung application requires two panels of corresponding width joined at 90°.
- ! When a run of worksurfaces equals or exceeds 6 feet, a floor support is required for worksurface structural assurance.
- ! 60"W, 66"W and 72"W worksurfaces require one or more of the following: worksurface support brackets, end panel, external channel universal support leg or pedestal support in conjunction with cantilever brackets.

HOW TO SPECIFY

| | | | |
|---|---|---|--|
| <p>Select Model Number</p> <p>No Grommet option: Add "N" suffix (no upcharge)</p> <p>HWV73AARP .</p> <p>HWV73AARP N .</p> | <p>Select Laminate</p> <p>See page 481</p> <p>AS .</p> <p>AS .</p> | <p>Select Edge Color</p> <p>See page 481</p> <p>K .</p> <p>K .</p> | <p>Select Grommet Color</p> <p>See page 481</p> <p>T1</p> |
|---|---|---|--|



SYSTEMS WORKSURFACES

Jetty / Peninsula

| | DESCRIPTION | MODEL | SHIP WEIGHT | CUBE | L1 LIST PRICE | L2 LIST PRICE |
|--|---|------------------|-------------|------|---------------|---------------|
| | Jetty Worksurfaces, Left Hand | | | | | |
| | 48" A x 66" B x 24" C x 30" D | HWJ58ABLP | 84 | 9.2 | \$923 | \$953 |
| | 48" A x 66" B x 30" C x 30" D | HWJ58BBLP | 91 | 9.2 | \$924 | \$954 |
| | 48" A x 72" B x 24" C x 30" D | HWJ59ABLP | 88 | 9.2 | \$929 | \$959 |
| | 48" A x 72" B x 30" C x 30" D | HWJ59BBLP | 94 | 9.2 | \$925 | \$955 |
| | ! Requires support column — see page 632. Order support column separately. | | | | | |
| | Jetty Worksurfaces, Right Hand | | | | | |
| | 48" A x 66" B x 24" C x 30" D | HWJ58ABRP | 84 | 9.2 | \$923 | \$953 |
| | 48" A x 66" B x 30" C x 30" D | HWJ58BBRP | 91 | 9.2 | \$924 | \$954 |
| | 48" A x 72" B x 24" C x 30" D | HWJ59ABRP | 88 | 9.2 | \$929 | \$959 |
| | 48" A x 72" B x 30" C x 30" D | HWJ59BBRP | 94 | 9.2 | \$925 | \$955 |
| | ! Requires support column — see page 632. Order support column separately. | | | | | |
| | Peninsula Worksurfaces | | | | | |
| | 60" W x 24" D | HWP2460P | 65 | 4.9 | \$433 | \$453 |
| | 66" W x 24" D | HWP2466P | 72 | 4.6 | \$528 | \$548 |
| | 72" W x 24" D | HWP2472P | 95 | 5.5 | \$594 | \$614 |
| | 60" W x 30" D | HWP3060P | 68 | 5.0 | \$693 | \$713 |
| | 66" W x 30" D | HWP3066P | 75 | 6.0 | \$761 | \$781 |
| | 72" W x 30" D | HWP3072P | 98 | 6.0 | \$837 | \$857 |
| | ! Peninsula worksurface width must correspond to the width of its support panel. Requires support column — see page 632. Order support column separately. | | | | | |

NOTES:

- Worksurfaces may be used with Accelerate®, Abound® and Voi® products.
- Worksurfaces are constructed of laminate on 1½" solid core high-performance particleboard.
- Order support column separately — see page 632.
- Can also be attached perpendicular to a primary worksurface using Flat Brackets. Do not attach to a worksurface supported with Cantilever Brackets.
- Add suffix "N" to Model Number for worksurfaces with no grommets. No upcharge.
- Refer to Worksurface Supports, pages 630-634.
- ! Not designed to be used freestanding.

HOW TO SPECIFY

| | | | |
|---|---|---|--|
| <p>Select Model Number</p> <p>No Grommet option: Add "N" suffix (no upcharge)</p> <p>HWJ58ABLP .</p> <p>HWJ58ABLPN .</p> | <p>Select Laminate</p> <p>See page 481</p> <p>AS .</p> <p>AS .</p> | <p>Select Edge Color</p> <p>See page 481</p> <p>K .</p> <p>K .</p> | <p>Select Grommet Color</p> <p>See page 481</p> <p>T1</p> |
|---|---|---|--|

SYSTEMS WORKSURFACES

Half-Round / Quarter Round / 60° Wedge

GSA SIN 33721



Icon Legend on page 19

WORKSTATIONS

Grain Direction

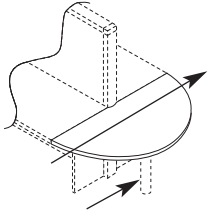

Requires Support Column — see page 632.

DESCRIPTION

Abound® Half-Round Worksurfaces

50"W x 30"D Connects to two 24"D Worksurfaces
62"W x 36"D Connects to two 30"D Worksurfaces

MODEL

HBWD2450P
HBWD3062P

SHIP WEIGHT

52
58

CUBE

5.0
6.1

L1 LIST PRICE

\$684
\$798

L2 LIST PRICE

\$699
\$818

Accelerate® Half-Round Worksurfaces

50"W x 30"D Connects to two 24"D Worksurfaces
62"W x 36"D Connects to two 30"D Worksurfaces

HCWD2450P
HCWD3062P

52
58

5.0
6.1

\$684
\$798

\$699
\$818

NOTES: Order one Support Column and two Universal Support Legs or Full End Panel — see pages 630-632.

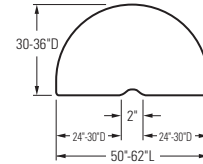

Grain Direction

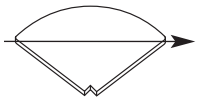

Abound® Quarter-Round Worksurfaces

24"W x 24"W Connects to two 24"D Worksurfaces
30"W x 30"W Connects to two 30"D Worksurfaces

HBWQ2424P
HBWQ3030P

18
25

2.6
3.7

\$393
\$492

\$408
\$512

Accelerate® Quarter-Round Worksurfaces

24"W x 24"W Connects to two 24"D Worksurfaces
30"W x 30"W Connects to two 30"D Worksurfaces

HCWQ2424P
HCWQ3030P

18
25

2.6
3.7

\$393
\$492

\$408
\$512

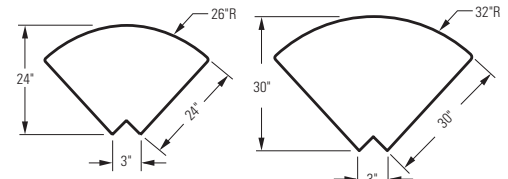

HBWQ2424P
HCWQ2424P

HBWQ3030P
HCWQ3030P

Grain Direction

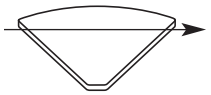

Abound® 60° Wedge Worksurfaces for use with 120 degree Universal Connector

24"W x 24"W Abound® Only
30"W x 30"W Abound® Only

HBWQT2424P
HBWQT3030P

18
25

2.6
3.7

\$436
\$506

\$451
\$526

Accelerate® 60° Wedge Worksurfaces for use with 120 degree Universal Connector

24"W x 24"W Accelerate® Only
30"W x 30"W Accelerate® Only

HCWQT2424P
HCWQT3030P

17
25

2.4
2.9

\$433
\$503

\$448
\$523

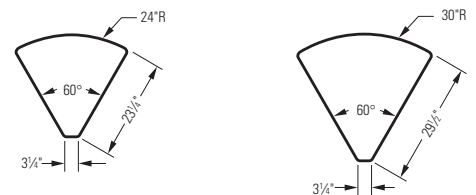

HBWQT2424P
HCWQT2424P

HBWQT3030P
HCWQT3030P

NOTES:

• Worksurfaces are constructed of laminate on 1/8" solid core high-performance particleboard.

Half-Round Worksurfaces

• Order Support Column and End Panels separately.

Quarter Round Worksurfaces

• Two Flat Brackets and one Tie Bracket included.

60° Wedge Worksurfaces

• Two flat brackets and one tie bracket included.
• Refer to Worksurface Supports, pages 630-634.

HOW TO SPECIFY

Select Model Number

HBWD2450P
HCWD2450P

Select Laminate

See page 481

A5
A5

Select Edge Color





See page 481

K
K

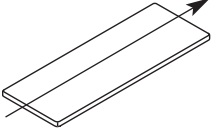

SYSTEMS COUNTERTOPS

Straight and Corner

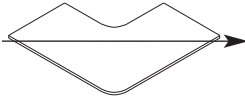
| | DESCRIPTION | MODEL | SHIP WEIGHT | CUBE | L1 LIST PRICE | L2 LIST PRICE |
|--|--|---|-------------|------|---------------|---------------|
| Grain Direction  | Abound® and Accelerate® 15"D Straight Countertops | | | | | |
| | 24"W x 15"D | HBCSR1524P | 19 | 1.4 | \$245 | \$255 |
| | 30"W x 15"D | HBCSR1530P | 25 | 1.4 | \$271 | \$281 |
| | 36"W x 15"D | HBCSR1536P  | 27 | 1.6 | \$303 | \$313 |
| | 42"W x 15"D | HBCSR1542P | 32 | 1.8 | \$311 | \$321 |
| | 48"W x 15"D | HBCSR1548P  | 38 | 2.1 | \$329 | \$339 |
| | 60"W x 15"D | HBCSR1560P  | 48 | 2.6 | \$417 | \$432 |
| | 66"W x 15"D | HBCSR1566P | 53 | 2.7 | \$431 | \$446 |
| | 72"W x 15"D | HBCSR1572P  | 59 | 3.1 | \$448 | \$463 |
| Grain Direction  | Abound® and Accelerate® 15"D Corner Countertops | | | | | |
| | 24"W x 24"D | HBCSR2424P | 44 | 1.4 | \$468 | \$483 |
| | 30"W x 30"D | HBCSR3030P | 51 | 1.4 | \$543 | \$558 |
| | 36"W x 36"D | HBCSR3636P | 58 | 1.6 | \$605 | \$625 |

NOTES:

- Countertops constructed with high-pressure laminate.
- Specify laminate and Edgeband options color.

HOW TO SPECIFY

| | | |
|---|---|---|
| Select Model Number H B C S R 1 5 2 4 P . | Select Laminate See page 481 A 5 . | Select Edge Color See page 481 K |
|---|---|---|

SYSTEMS COUNTERTOPS

Straight and Corner

GSA SIN 33721



Icon Legend on page 19

WORKSTATIONS

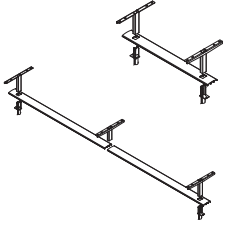

| DESCRIPTION | FLAT MODEL | CHAMFERED MODEL | SHIP WEIGHT | CUBE | LIST PRICE BY PAINT GRADE | |
|--|------------|-----------------|-------------|------|---------------------------|-------|
| | | | | | P1 | P2 |
| Abound® Raised Straight Countertop Kits | | | | | | |
| 24"W | HRVBR1524F | HRVBR1524 | 5 | 1.0 | \$148 | \$165 |
| 30"W | HRVBR1530F | HRVBR1530 | 5 | 1.0 | \$155 | \$172 |
| 36"W | HRVBR1536F | HRVBR1536 | 6 | 2.0 | \$164 | \$181 |
| 42"W | HRVBR1542F | HRVBR1542 | 6 | 2.0 | \$169 | \$186 |
| 48"W | HRVBR1548F | HRVBR1548 | 7 | 2.0 | \$176 | \$193 |
| 60"W | HRVBR1560F | HRVBR1560 | 8 | 2.0 | \$209 | \$226 |
| 66"W | HRVBR1566F | HRVBR1566 | 8 | 3.0 | \$223 | \$240 |
| 72"W | HRVBR1572F | HRVBR1572 | 9 | 3.0 | \$240 | \$257 |

! Do not order top caps for the panels the Countertop Kits will be installed on. Countertop Kits come with the necessary top caps and hardware.

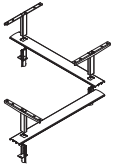

| | | | | | | |
|--|-------------|------------|---|-----|-------|-------|
| Abound® Raised Corner Countertop Kits | | | | | | |
| 24"W | HRVBR1524PF | HRVBR1524P | 5 | 1.0 | \$184 | \$201 |
| 30"W | HRVBR1530PF | HRVBR1530P | 6 | 1.0 | \$193 | \$210 |
| 36"W | HRVBR1536PF | HRVBR1536P | 6 | 2.0 | \$202 | \$219 |

! Do not order top caps for the panels the Countertop Kits will be installed on. Countertop Kits come with the necessary top caps and hardware.

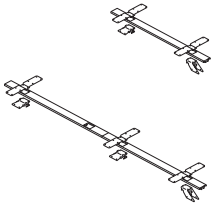

| | | | | | | |
|---|-----------|----------|---|-----|------|------|
| Abound® Straight Countertop Kits | | | | | | |
| 24"W | HBCKIT24F | HBCKIT24 | 5 | 0.7 | \$57 | \$62 |
| 30"W | HBCKIT30F | HBCKIT30 | 5 | 0.9 | \$60 | \$66 |
| 36"W | HBCKIT36F | HBCKIT36 | 6 | 0.9 | \$62 | \$68 |
| 42"W | HBCKIT42F | HBCKIT42 | 6 | 1.2 | \$64 | \$70 |
| 48"W | HBCKIT48F | HBCKIT48 | 7 | 1.4 | \$66 | \$72 |
| 60"W | HBCKIT60F | HBCKIT60 | 8 | 1.8 | \$69 | \$76 |
| 66"W | HBCKIT66F | HBCKIT66 | 8 | 1.8 | \$72 | \$79 |
| 72"W | HBCKIT72F | HBCKIT72 | 9 | 1.9 | \$74 | \$81 |

! Straight Countertop Kits must match the width of the corresponding panel onto which they are installed.

! 66"W kit must be used with 30" and 36"W frames.

! 72"W kit must be used with two 36"W frames.

! Do not order top caps for the panels onto which the Countertop Kits are installed. Countertop Kits come with the necessary top caps and hardware.

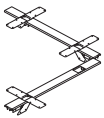

| | | | | | | |
|---------------------------------------|-----------|----------|---|-----|------|------|
| Abound® Corner Countertop Kits | | | | | | |
| 24"W | HBCKIT24F | HBCKIT24 | 5 | 0.7 | \$68 | \$74 |
| 30"W | HBCKIT30F | HBCKIT30 | 6 | 1.0 | \$76 | \$83 |
| 36"W | HBCKIT36F | HBCKIT36 | 6 | 1.0 | \$78 | \$85 |

! Do not order top caps for the panels the Countertop Kits will be installed on. Countertop Kits come with the necessary top caps and hardware.

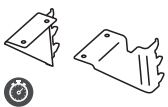

| | | | | | |
|---|---------------|----------|------------|-------------|-------------|
| Accelerate® Countertop Bracket Kit | HECB01 | 1 | 0.1 | \$60 | \$63 |
|---|---------------|----------|------------|-------------|-------------|

! For use with all panel heights, except 42½".

! Top caps required and specified separately from Accelerate® Countertop Bracket Kits.

| | | | | | |
|--|---------------|----------|------------|-------------|-------------|
| Accelerate® Countertop Bracket Kit for 42½"H Panels | HECB42 | 1 | 0.1 | \$60 | \$63 |
|--|---------------|----------|------------|-------------|-------------|

! For use with 42½"H Panels only.

! Top caps required and specified separately from Accelerate® Countertop Bracket Kits.

! Bracket kits include one right and one left hand bracket. Order two sets of brackets for the straight countertop models and three sets for the corner countertop models. To be used on Accelerate® panels only.

SPECIFYING EXAMPLE: HECB01.LOFT

HOW TO SPECIFY

Select Model Number

Select Paint Color

See page 481

HRVBR1524

A5



Icon Legend on page 19

SYSTEMS SHELVES

Corner Shelves

| DESCRIPTION | MODEL | SHIP WEIGHT | CUBE | L1 | L2 |
|---|-----------------|-------------|------|--------------|--------------|
| | | | | LIST PRICE | LIST PRICE |
| Corner Shelves 36" x 36" x 12"D 42" x 42" x 12"D | HCS3636P | 33 | 3.6 | \$445 | \$465 |
| | HCS4242P | 33 | 3.6 | \$466 | \$491 |

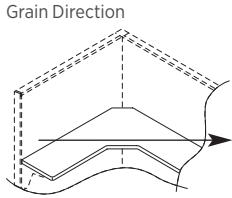

NOTES:

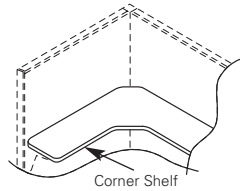

- Corner Shelves may be used with both Abound® and Accelerate® systems products.
- Diagonal leading edge = 10½"
- Diagonal depth = 22½"
- Includes panel attachment brackets.

HOW TO SPECIFY

| | | | |
|--|--|---|---|
| Select Model Number HCS3636P | Select Laminate See page 481 A5 | Select Edge Color See page 481 K | Select Paint Color See page 481 T1 |
|--|--|---|---|

| DESCRIPTION | MODEL | SHIP WEIGHT | CUBE | LIST PRICE BY PAINT GRADE |
|--|----------------|-------------|------|---------------------------|
| | | | | P1 |
| Power Hub, 3" Grommet Mount, 6' Cord • Fits in 3" round grommet holes on the following product lines: 10500, 10700, Coordinate and Voi desks; Systems Worksurfaces; Huddle and Motivate tables and SmartLink. • Two grounded AC power outlets. • Includes 6' cord with three-prong plug. • Field installed with Plug-and-play ease. | HGRMTAC | 1.3 | 0.2 | \$126 |

NOTES: For additional information see the Workplace Tools section in the 2021 Shared Spaces Pricer.

ⓘ Available in black only (no color designation so use .X - Specify: HGRMTAC.X).

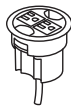

SIN 33721T

SYSTEMS Worksurface Supports

GSA SIN 33721



Icon Legend on page 19

WORKSTATIONS

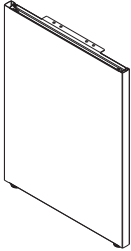

Specify paint

| DESCRIPTION | MODEL | SHIP WEIGHT | CUBE | LIST PRICE BY PAINT GRADE | |
|--|------------|-------------|------|---------------------------|-------|
| | | | | P1 | P2 |
| Abound® and Accelerate® Full End Panel* | | | | | |
| 29½" H x 11" D — Right — Panel Mount | HRVEP1129R | 16 | 1.4 | \$228 | \$257 |
| 29½" H x 11" D — Left — Panel Mount | HRVEP1129L | 16 | 1.4 | \$228 | \$257 |
| 29½" H x 24" D — Right — Panel Mount | HRVEP2429R | 21 | 1.4 | \$246 | \$275 |
| 29½" H x 24" D — Left — Panel Mount | HRVEP2429L | 21 | 1.4 | \$246 | \$275 |
| 29½" H x 30" D — Right — Panel Mount | HRVEP3029R | 23 | 1.4 | \$268 | \$297 |
| 29½" H x 30" D — Left — Panel Mount | HRVEP3029L | 23 | 1.4 | \$268 | \$297 |

NOTES: The use of an end panel at the end of a worksurface will increase the rigidity of the workstation. If the panel is a greater dimension than the worksurface, an end panel is required if the run of the worksurfaces is 8 feet or greater. Levelers provide 1½" vertical adjustment.

- ! *Must be connected into panel slots. When an installation of worksurfaces is 8 feet or greater, a full end panel or universal support leg must be used at 90 degree panel junctions or in a shared position to support adjoining worksurfaces.
- ! End panel support with bracket will attach to both Accelerate® and Abound® panels.

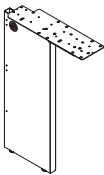

Non-handed unit
Specify paint

| DESCRIPTION | MODEL | SHIP WEIGHT | CUBE | LIST PRICE BY PAINT GRADE | |
|---|----------|-------------|------|---------------------------|-------|
| | | | | P1 | P2 |
| Abound® and Accelerate® Universal Support Leg* | | | | | |
| 29½" H to support 24" D | HRVCLG24 | 16 | 1.4 | \$218 | \$247 |
| 29½" H to support 30" D | HRVCLG30 | 17 | 1.4 | \$238 | \$267 |

NOTES: Use at 90° panel junctions or in a shared position to support adjoining worksurfaces. Provided with flat bracket. Levelers provide 1½" vertical adjustment.

- ! *Must be connected into panel slots. When an installation of worksurfaces is 8 feet or greater, a full end panel or universal support leg must be used at 90 degree panel junctions or in a shared position to support adjoining worksurfaces.

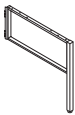

| DESCRIPTION | MODEL | SHIP WEIGHT | CUBE | LIST PRICE BY PAINT GRADE | |
|-------------------------|---------|-------------|------|---------------------------|-------|
| | | | | P1 | P2 |
| Open Leg Models* | | | | | |
| 29½" H x 12" D | HOLEG12 | 7 | 0.5 | \$163 | \$192 |
| 29½" H x 18" D | HOLEG18 | 9 | 1.4 | \$188 | \$217 |
| 29½" H x 24" D | HOLEG24 | 11 | 1.2 | \$228 | \$257 |
| 29½" H x 30" D | HOLEG30 | 15 | 1.8 | \$249 | \$278 |

NOTES: Open leg includes attaching hardware and leveling glides. Leveling glides provide 2¼" of adjustment. Open leg is universal shared with a left- and right-hand attachment bracket.

- ! *Must be connected into frame slots. Specify paint.

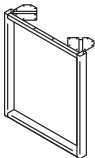

| DESCRIPTION | MODEL | SHIP WEIGHT | CUBE | LIST PRICE BY PAINT GRADE | |
|---------------------------------------|-----------|-------------|------|---------------------------|-------|
| | | | | P1 | P2 |
| O-Leg Support for Worksurfaces | | | | | |
| 20" D x 28½" H | HLSL2028O | 15 | 3.7 | \$328 | \$332 |
| 24" D x 28½" H | HLSL2428O | 17 | 3.7 | \$357 | \$361 |
| 30" D x 28½" H | HLSL3028O | 19 | 5.4 | \$395 | \$399 |

NOTES: Ship fully assembled, 1/pack. Non-handed. Use the anti-dislodgement bracket when using a worksurface in a peninsula application with a post or O-leg.



| DESCRIPTION | MODEL | SHIP WEIGHT | CUBE | LIST PRICE BY PAINT GRADE | | |
|---|---------|-------------|------|---------------------------|-------|-----|
| | | | | P1 | P2 | P3 |
| Voi® for Systems O-Leg-to-Panel Attachment Bracket | | | | | | |
| Left handed bracket (quantity 1) | HLSLPBL | 3 | 0.4 | \$111 | \$115 | N/A |
| Right handed bracket (quantity 1) | HLSLPBR | 3 | 0.4 | \$111 | \$115 | N/A |

NOTES: Used to connect Voi O-Leg to a systems panel for additional workstation rigidity. Bracket designed to work with edgeband worksurfaces only. Brackets are handed, come one per package and include self-tapping screws. Specify paint.

NOTES:

- The supports included on this page can be used with Systems and Worksurfaces.

HOW TO SPECIFY

| | |
|---|---|
| <p>Select Model Number</p> <p>HRVEP1129R.</p> | <p>Select Paint Color</p> <p>See page 183</p> <p>T1</p> |
|---|---|



SYSTEMS Worksurface Supports

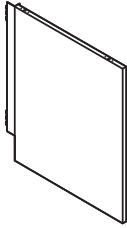

| DESCRIPTION | MODEL | SHIP WEIGHT | CUBE | LIST PRICE BY PAINT GRADE | |
|--|--------------------|-------------|------|---------------------------|--------------|
| | | | | P1 | P2 |
| Laminate End Panel Support with Panel Bracket | | | | | |
| 29½”H x 24”D, Left handed | HLSL2428EBL | 3 | 2.2 | \$290 | \$294 |
| 29½”H x 24”D, Right handed | HLSL2428EBR | 3 | 2.2 | \$290 | \$294 |
| 29½”H x 30”D, Left handed | HLSL3028EBL | 3 | 3.2 | \$308 | \$312 |
| 29½”H x 30”D, Right handed | HLSL3028EBR | 3 | 3.2 | \$308 | \$312 |

NOTES: Includes laminate end panel and brackets to attach end panel support to a panel. Order to correspond to worksurface depth. Specify laminate and paint. Can be used with Abound® and Accelerate® Systems products.

NOTES:

- The supports included on this page and on previous page can be used with Systems and Worksurfaces.

HOW TO SPECIFY

| | | |
|--|--|---|
| <p>Select Model Number</p> <p>H L S L 2 4 2 8 E B L .</p> | <p>Select Laminate</p> <p>L2 Laminate Upcharge \$10 See page 481</p> <p>H .</p> | <p>Select Paint Color</p> <p>See page 481</p> <p>T 1</p> |
|--|--|---|

SYSTEMS Worksurface Supports

GSA SIN 33721



Icon Legend on page 19

WORKSTATIONS

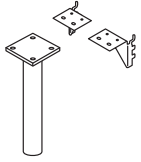

Non-handed unit
Specify paint

DESCRIPTION

Support Column*

For 29½" Height. 3" diameter.

NOTES: Used to support one end of a peninsula, round or half-round worksurface. (Includes panel support brackets.) Levelers provide 1½" vertical adjustment.

! *Brackets must be connected into panel slots.

MODEL

SHIP WEIGHT

CUBE

LIST PRICE BY PAINT GRADE

P1

P2

HCNLEG29

13

1.1

\$240

\$267



Post Leg Base

• Single Post Leg with Hardware Pack

• Requires hardware bracket model HWSA2. Please see below for HWSA2 bracket ordering information.

HMBPOST1

18

2.3

\$325

\$337

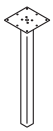

Post Leg Base

28½"H x 2" square

NOTES: Requires hardware bracket model HWSA2 when used to support a peninsula.

HLSL28P

15

1.0

\$321

\$325

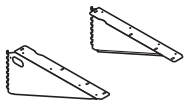

Specify paint

Accessory Cantilever*

18"D Pair

24"D Pair

18"D Right-Hand Cantilever

18"D Left-Hand Cantilever

24"D Right-Hand Cantilever

24"D Left-Hand Cantilever

HCTL182

4

0.3

\$74

\$84

HCTL242

5

0.3

\$93

\$103

HCTL181R

3.2

0.2

\$40

\$50

HCTL181L

3.2

0.2

\$40

\$50

HCTL241R

3.7

0.6

\$50

\$60

HCTL241L

3.7

0.6

\$50

\$60

! *Must be connected into panel slots.

! Accelerate® only: Cantilevers only to be used on worksurface runs 72"W or less.

! Use with runs 72" or less – avoid installation on only one side of a straight connection except to support corner worksurfaces. Floor support is required for runs longer than 72".

! DO NOT position at the end of a panel run where no 90 degree return panel is positioned.

! DO NOT use to support worksurfaces from which a hanging pedestal is suspended, or to which a peninsula worksurface is attached.

! DO NOT use cantilever brackets to support worksurfaces supported with permanent wall hanger kit.

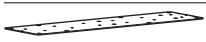

Flat Bracket

18"D

24"D

30"D

HHN831118

3

0.2

\$70

N/A

HHN831124

3

0.3

\$72

N/A

HHN831130

3

0.4

\$72

N/A

NOTES: Flat Brackets can be used to connect one worksurface perpendicular to another worksurface.

! Charcoal only.

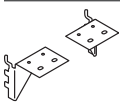

Specify paint

Worksurface Bracket Kit*

One Pair

HWSB2

1

0.1

\$52

\$55

NOTES: Used to connect the end of a worksurface to a panel of the same width.

! Always use when the depth side of a worksurface is against a panel (return/wing panel) of the same dimension. This will increase the sturdiness of the workstation.

! *Must be connected into panel slots.

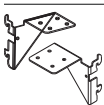

Anti-Dislodgement Bracket Kit

HWSA2

1

0.1

\$50

\$53

NOTES: To be used with models HMBPOST1 and HLSL28P Post Leg Base.

NOTES:







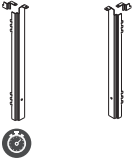

• The supports included on this page can be used with Systems Worksurfaces.

HOW TO SPECIFY

| | |
|--|---|
| <p>Select Model Number</p> <p>H C T L 2 4 2 .</p> | <p>Select Paint Color</p> <p>See page 481</p> <p>T 1</p> |
|--|---|



WORKSURFACE BRACKETS

| | DESCRIPTION | MODEL | SHIP WEIGHT | CUBE | LIST PRICE BY PAINT GRADE | | |
|--|---|-------------|---|------|---------------------------|-------|-------|
| | | | | | P1 | P2 | P3 |
|  | Flagship® Pedestal to Panel Bracket Kit, Left | HPD2PNBRK2L | 3.0  | 0.3 | \$122 | \$130 | \$132 |
| | Flagship® Pedestal to Panel Bracket Kit, Right | HPD2PNBRK2R | 3.0  | 0.3 | \$122 | \$130 | \$132 |
| NOTES: Bracket to attach 22 ⁷ / ₈ "D pedestals to 24"D worksurface or 28 ⁷ / ₈ "D pedestals to 30"D worksurface. | | | | | | | |
|  | Worksurface to Tower Bracket Kit | | | | | | |
| | Bracket to attach storage towers to worksurfaces. | HSTB2W1 | 4.0  | 0.6 | \$88 | \$101 | \$103 |
| NOTES: Replaces the need for a panel attached end panel. Standard with hardware to attach bracket to panel and worksurface. | | | | | | | |
|  Bracket cannot be used as a support when placing Stack-on Storage on worksurface over bracket. Must use two full-sized supports when using Stack-on Storage. | | | | | | | |
|  Not for use with systems support pedestals. | | | | | | | |
|  | Worksurface-to-Wing Panel Bracket | | | | | | |
| | 24"W | HWSR24 | 2.5 | 0.4 | \$65 | N/A | N/A |
| | 30"W | HWSR30 | 3.0 | 0.4 | \$65 | N/A | N/A |
| | 36"W | HWSR36 | 3.5 | 0.5 | \$65 | N/A | N/A |
| | 42"W | HWSR42 | 4.0 | 0.5 | \$65 | N/A | N/A |
| | 48"W | HWSR48 | 4.5 | 0.6 | \$65 | N/A | N/A |
| NOTES: | | | | | | | |
| • To be used when the adjacent wing panel is wider than the worksurface depth. | | | | | | | |
| • Specify support to the same width as your adjacent wing panel, not the depth of your worksurface. | | | | | | | |
| • Support spans the entire width of the wing panel. | | | | | | | |
| • Supports are non-handed. | | | | | | | |

HOW TO SPECIFY

| | |
|--|---|
| <p>Select Model Number</p> <p>HPD2PNBRK2L . T1</p> | <p>Select Paint Color</p> <p>See page 481</p> |
|--|---|

SYSTEMS

Worksurface Supports

GSA SIN 33721



Icon Legend on page 19

WORKSTATIONS

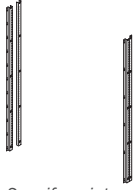

Specify paint

| DESCRIPTION | MODEL | SHIP WEIGHT | CUBE | LIST PRICE BY PAINT GRADE | |
|---|------------------|-------------|------|---------------------------|--------------|
| | | | | P1 | P2 |
| Abound® and Accelerate® Permanent-Wall Hanger Kit Wall Hanger Kit (2 pieces) 2½"W x ⅞"D x 66"H | HRVC35PCE | 6 | 0.7 | \$243 | \$263 |
| Wall Hanger Kit 4¼"W x ⅞"D x 66"H | HRVC35PCM | 3 | 0.7 | \$128 | \$138 |

NOTES: Anchor devices are not supplied with these models. Refer to Abound® or Accelerate® Installation instructions for appropriate hardware. Used to hang storage cabinets and bookshelves from permanent wall, and/or to attach worksurfaces to permanent wall.

- ⓘ Attachment to masonry walls is not recommended.
- ⓘ Worksurfaces should not be supported with Cantilever brackets when using Permanent-Wall Hanger Kit.

NOTES:

- Wall track has ⅛" x ½" slots on 1" centers.
- Customer to furnish connecting hardware. (Refer to Installation Instructions for appropriate hardware.)
- Includes a cover for top of channel.

HOW TO SPECIFY

| | |
|---|---|
| Select Model Number HRVC35PCE | Select Paint Color See page 481 T1 |
|---|---|

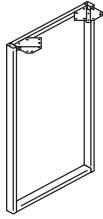

STANDING-HEIGHT WORKSURFACE SUPPORTS

**DESCRIPTION****Standing-Height O-Leg Support for Worksurfaces**

24"D x 41"H

30"D x 41"H

NOTES: Ship fully assembled, 1/package. Non-handed.

MODEL**HLSL2441O****HLSL3041O****SHIP
WEIGHT**

16

17

CUBE

5.3

6.5

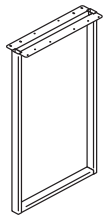
LIST PRICE BY PAINT GRADE**P1****\$476****\$533****P2****\$482****\$539****Standing-Height O-Leg Shared Support for Worksurfaces**

24"D x 41"H

30"D x 41"H

NOTES: Ship fully assembled, 1/package. Non-handed.

HLSL2441SL**HLSL3041SL**

16

17

5.3

6.5

\$537**\$593****\$543****\$599****NOTES:**

- O-leg glides have 2" adjustability.
- Shared O-legs create a cleaner aesthetic in all applications where two legs are used side-by-side.
- O-Leg to Panel Attachment Brackets are used to connect Voi® O-Legs to a systems panel for additional worksurface rigidity.

! O-legs may only be attached to worksurfaces, not storage units.

HOW TO SPECIFY

Select
Model Number

H L S L 2 4 4 1 O

Select
Paint Color

See page 183

T 1

SYSTEMS

Standard Height Support Pedestals

GSA SIN 33721



Icon Legend on page 19

WORKSTATIONS

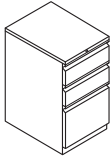

DESCRIPTION

Standard Height Freestanding Support Pedestals — Box/Box/File
 15"W x 19⁷/₈"D x 28"H
 15"W x 22⁷/₈"D x 28"H

MODEL

HVFB20R
HVFB23R ⓘ

SHIP WEIGHT

89.0
 95.0

CUBE

7.0
 8.0

LIST PRICE BY PAINT GRADE

| P1 | P2 | P3 |
|-------|-------|-------|
| \$597 | \$625 | \$641 |
| \$614 | \$642 | \$659 |

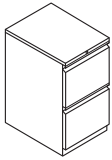

Standard Height Freestanding Support Pedestals — File/File
 15"W x 19⁷/₈"D x 28"H
 15"W x 22⁷/₈"D x 28"H

HVFF20R
HVFF23R ⓘ

88.0
 94.0

7.0
 8.0

| P1 | P2 | P3 |
|-------|-------|-------|
| \$591 | \$619 | \$635 |
| \$609 | \$637 | \$654 |

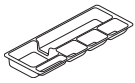

Optional Pencil Tray

HV-UT1

0.5

0.1

\$77

N/A

N/A

NOTES: For additional information see the Workplace Tools section in the 2021 Shared Pricer.

ⓘ For use with mobile and freestanding pedestal models shown above.

NOTES:

- 28"H fits under all HON worksurfaces and desk shells.
- Ball-bearing suspension on file drawer (90% extension), and box drawer (90% extension on both drawers).
- File drawers have high sides for filing front-to-back.
- Available in "R" pull only.
- Pencil tray standard in top box drawer.
- One box divider standard in each box drawer.
- One crossrail standard in each file drawer.

ⓘ Freestanding models must be used under a worksurface only.

HOW TO SPECIFY

Select Model Number

H V F B 2 0 R .

Select Lock Option

L Lock (no upcharge)

L .

Select Paint Color

See page 481

P

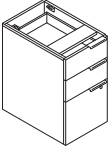
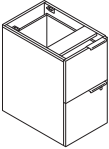
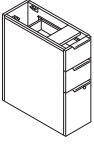

Laminate Support Pedestals

| | DESCRIPTION | MODEL | SHIP WEIGHT | CUBE | L1 LIST | L2 UPCHARGES | |
|---|--|------------------|-------------|------|--------------|--------------|-------------|
| | | | | | | CHASSIS | FRONTS |
|  | Support Pedestals — Box/Box/File | | | | | | |
| | 16"W x 20"D x 28½"H | HLSL2028B | 73 | 7.3 | \$773 | \$15 | \$10 |
| | 16"W x 24"D x 28½"H | HLSL2428B | 85 | 8.5 | \$855 | \$20 | \$10 |
| | 16"W x 30"D x 28½"H | HLSL3028B | 105 | 10.5 | \$962 | \$25 | \$10 |
| | NOTES: Top box drawer does not lock. | | | | | | |
|  | Support Pedestals — File/File | | | | | | |
| | 16"W x 20"D x 28½"H | HLSL2028F | 72 | 7.3 | \$773 | \$15 | \$10 |
| | 16"W x 24"D x 28½"H | HLSL2428F | 84 | 8.5 | \$855 | \$20 | \$10 |
| | 16"W x 30"D x 28½"H | HLSL3028F | 104 | 10.5 | \$962 | \$25 | \$10 |
| | NOTES: Top box drawer does not lock. | | | | | | |
|  | Slim Profile Pedestals — Box/Box/File | | | | | | |
| | 9½"W x 24"D x 28½"H | HLSL2428S | 69 | 6.9 | \$848 | \$20 | \$10 |
| | 9½"W x 30"D x 28½"H | HLSL3028S | 56 | 5.6 | \$931 | \$25 | \$10 |
| | NOTES: Top box drawer does not lock. | | | | | | |

NOTES:

- Please see Voi® section of the pricer for full Voi® laminate offering, which is compatible with all HON systems series.
 - Voi® Support and Power-Ready Pedestals can be used with worksurfaces.
 - A variety of pedestals, end panels, and O-legs can be combined to create a conventional or contemporary desk.
 - Chassis and drawer front woodgrain and solid laminates are specified separately (see SIF options below).
 - File drawers accept hanging folders in letter or legal size.
 - Multiple handle locations possible per customer preference.
 - Ships with one handle per drawer.
 - Drawer Organizer model HLSLDRWORG works with box drawers.
 - Box and file drawers operate on ball-bearing suspension with full extension.
 - Adjustable hex leveling glides allow floor-standing furniture to be easily leveled without lifting the unit; glides have 1¼" adjustable range.
- ① Pedestals ship fully assembled but must attach to a worksurface with a quick release bracket, provided. Pedestals are non-handed and are interchangeable.
- ① Locking units equipped with HON "One Key" interchangeable core removable locks. Keyed alike core must be ordered separately.

HOW TO SPECIFY

| | | | |
|--|--|---|---|
| <p>Select Model Number</p> <p>H L S L 2 0 2 8 B .</p> | <p>Select Chassis Laminate</p> <p>See page 183</p> <p>N .</p> | <p>Select Drawer Front Laminate</p> <p>See page 183</p> <p>N .</p> | <p>Select Pull Color</p> <p>P Black T4 Champagne T1 Platinum PJW Designer White PR6 Silver P8X Solar Black</p> <p>T 4</p> |
|--|--|---|---|

VOI® Laminate Support Storage

GSA SIN 33721



Icon Legend on page 19

WORKSTATIONS

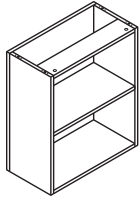

DESCRIPTION

Bookcase Support
24"W x 12"D x 28½"H
30"W x 12"D x 28½"H

| MODEL | SHIP WEIGHT | CUBE | L1 LIST | L2 UPCHARGES | |
|------------------|-------------|------|--------------|--------------|------------|
| | | | | CHASSIS | FRONTS |
| HLSL240BC | 60 | 3.0 | \$574 | \$20 | N/A |
| HLSL300BC | 75 | 3.0 | \$600 | \$25 | N/A |

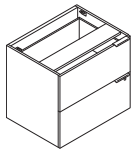

Lateral File — 2 Drawer
31⅜"W x 24"D x 28½"H

| | | | | | |
|------------------|-----|------|---------------|-------------|-------------|
| HLSL2430L | 121 | 15.6 | \$1325 | \$35 | \$20 |
|------------------|-----|------|---------------|-------------|-------------|

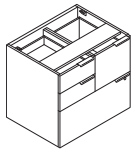

Multi File Lateral File
31⅜"W x 24"D x 28½"H
NOTES: Box drawers do not lock.

| | | | | | |
|-------------------|-----|------|---------------|-------------|-------------|
| HLSL2430MF | 163 | 15.6 | \$1574 | \$35 | \$20 |
|-------------------|-----|------|---------------|-------------|-------------|

NOTES:

- Voi® Support and Power-Ready Storage can be used with Systems Worksurfaces.
- Ships with one handle per drawer on all units.
- A variety of pedestals, end panels, and O-legs can be combined to create a conventional or contemporary desk.
- Bookcase can only mount exterior facing under a worksurface.
- Chassis and drawer front woodgrain and solid laminates are specified separately (see SIF options below).
- File drawers accept hanging folders in letter or legal size.
- Multiple handle locations possible per customer preference.
- Storage accessory model HLSLDRWORG works with box doors.
- Standard box drawers operate on ball-bearing suspension with full extension. File, lateral, and wide box drawers operate on ball-bearing suspension with full extension.
- Adjustable hex leveling glides allow floor-standing furniture to be easily leveled without lifting the unit; glides have 2" adjustable range.
- When using two lateral files, a 60" worksurface cannot be used, a 66" worksurface must be specified, which will show a gap.

- ❗ Cannot fit binders on both shelves of bookcase model HLSL240BC and HLSL300BC.
- ❗ Must be specified under a worksurface 60"W or wider.
- ❗ Locking units equipped with HON "One Key" interchangeable core removable locks. Keyed alike core must be ordered separately.

HOW TO SPECIFY

| | | | |
|--|--|--|--|
| <p>Select Model Number</p> <p>H L S L 2 4 3 0 L</p> | <p>Select Chassis Laminate</p> <p>See page 183</p> <p>N</p> | <p>Select Laminate</p> <p>See page 183</p> <p>N</p> | <p>Select Pull Color</p> <p>P Black T4 Champagne T1 Platinum PJW Designer White PR6 Silver P8X Solar Black</p> <p>T 4</p> |
|--|--|--|--|

| | DESCRIPTION | MODEL | SHIP WEIGHT | CUBE | LIST PRICE BY PAINT GRADE | | |
|--------------------|---|------------------|--------------------|-------------|---------------------------|-------|-------|
| | | | | | P1 | P2 | P3 |
| | Paper Management Support Bars | | | | | | |
| | 24"W x 5"H | HNPBMSW24 | 1.3 | 0.4 | \$210 | \$222 | \$232 |
| | 30"W x 5"H | HNPBMSW30 | 1.5 | 0.5 | \$224 | \$236 | \$246 |
| | 36"W x 5"H | HNPBMSW36 | 2.0 | 0.6 | \$232 | \$244 | \$254 |
| | 42"W x 5"H | HNPBMSW42 | 5.0 | 0.7 | \$244 | \$256 | \$266 |
| | 48"W x 5"H | HNPBMSW48 | 7.0 | 0.8 | \$254 | \$266 | \$276 |
| | 60"W x 5"H | HNPBMSW60 | 9.0 | 0.9 | \$289 | \$301 | \$311 |
| | Recommended weight capacity not to exceed 80 pounds. Paper management bar attaches to Systems panels/frames to accommodate work flow accessories. | | | | | | |
| | Paper Shelf 15"W x 9 1/2"D x 2"H | HPPMPS | 2.0 | 0.3 | \$110 | \$122 | \$133 |
| | NOTES: Holds letter size paper and inter-office envelopes. | | | | | | |
| | Accessory Shelf 21 3/4"W x 7"D x 2"H | HPPMAS | 2.0 | 0.3 | \$114 | \$126 | \$137 |
| | NOTES: Holds office supplies and personal effects. | | | | | | |
| | Phone Tray 9"W x 10 3/4"D x 2"H | HPPMPT | 2.0 | 0.3 | \$139 | \$151 | \$162 |
| | NOTES: Holds telephone at optimum ergonomic angle. | | | | | | |
| | CD/Pencil Holder 5 1/4"W x 1 1/2"D x 5"H | HPPMPB | 1.0 | 0.2 | \$114 | \$126 | \$137 |
| | NOTES: Can store up to 3 CD jewel cases; sticky pads or writing instruments. | | | | | | |
| | Sorter Tray 6"W x 10"D x 2 1/2"H | HPPMST | 2.0 | 0.3 | \$150 | \$162 | \$173 |
| | NOTES: Provides 3 slots for organizing files. | | | | | | |
| | Folder Bin 12 1/4"W x 1 1/4"D x 9"H | HPPMFB | 2.0 | 0.3 | \$114 | \$126 | \$137 |
| | NOTES: Accommodates manila envelopes and can be hung from other folder binds to maximize storage. | | | | | | |
| | DESCRIPTION | MODEL | SHIP WEIGHT | CUBE | LIST PRICE | | |
| | Markerboards | | | | | | |
| | 36"W x 24"H | HHMRK36 | 15.0 | 3.2 | \$546 | | |
| | 42"W x 24"H | HHMRK42 | 17.0 | 4.0 | \$591 | | |
| | 48"W x 24"H | HHMRK48 | 19.0 | 4.6 | \$637 | | |
| | No color specification required. | | | | | | |
| | Back Pack Hook (10 per carton) 12"W x 14 1/2"D x 1 1/2"H | HCLA65 | 10.0 | 0.1 | \$101 | | |
| | NOTES: Assembly; attaches to bottom of desk with (2) screws, included. | | | | | | |
| | Available in Titanium finish only, no specification needed. | | | | | | |
| OPEN MARKET | | | | | | | |
| | | | | | | | |

HOW TO SPECIFY

| | |
|---|--|
| Select Model Number H N P M B S W 2 4 | Select Paint Color See page 481 P 8 S |
|---|--|

SYSTEMS

Accessories — Task Lights

GSA SIN 33721



Icon Legend on page 19

WORKSTATIONS



DESCRIPTION

Articulating Desk Lamp Articulating Desk Lamp w/ Occupancy Sensor

- Color: Matte Silver.
- Full-range dimming from 10% to 100%.
- Designed for 50,000 hours of life.
- Occupancy sensor is built into the head of the lamp and will automatically shut the lamp off after 6 minutes of undetected movement.
- Base swivel is 180 degrees.
- Uses only 5 watts of energy.
- Light comes with a silver 9' 4" power cord.
- Base diameter is 7.5".
- 3500K Color Temperature.
- 80 Color Rendering Index.
- TAA Compliant.

MODEL SHIP WEIGHT CUBE LIST PRICE

| | | | |
|----------------|-----|-----|--------------|
| HLED1 | 1.2 | 6.5 | \$430 |
| HLED1OC | 1.2 | 6.5 | \$524 |



Task Desk Lamp

- Color: Brushed Nickel.
- Full-range dimming from 10% to 100%.
- Designed for 50,000 hours of life.
- Lamp is 15.83" tall.
- Desk lamp does not articulate at base. The pivoting head provides custom positioning, as it can be twisted 360 degrees.
- Uses only 5 watts of energy.
- Light comes with a silver 9' 4" power cord.
- Base diameter is 6.7".
- 3500K Color Temperature.
- 80 Color Rendering Index.
- TAA Compliant.

| | | | |
|--------------|-----|-----|--------------|
| HLED2 | 0.7 | 3.0 | \$373 |
|--------------|-----|-----|--------------|











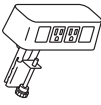

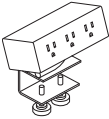

NOTES:

- For additional information see the Workplace Tools section in the 2021 Shared Spaces Pricer.

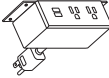
HOW TO SPECIFY

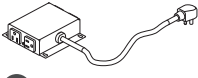
Select Model Number

HLED1

| | DESCRIPTION | MODEL | SHIP WEIGHT | CUBE | LIST PRICE |
|---|--|---|---|---|---|
|  | <p>Power & Data Center</p> <p>2 Receptacles 2 Data Accessory</p> <ul style="list-style-type: none"> Standard with two receptacles and openings for two data ports. 6' power cord with standard three-prong plug. Fits on any worksurface with a 4" overhang. UL Listed. <p>! Color finish coordinates with HON's Loft. <i>Specify LOFT when ordering. Example: HCOMDOME2.LOFT</i></p> | HCOMDOME2 | 2.5  | 0.2 | \$327 |
|  | <p>Power Modules</p> <p>3 Receptacles with Worksurface Clamp</p> <p>3 Receptacles with Under-Worksurface Mounting Bracket</p> <p>2 Receptacles 2 USB with Worksurface Clamp</p> <p>2 Receptacles 2 USB with Under-Worksurface Mounting Bracket</p> <ul style="list-style-type: none"> 6' power cord with standard three-prong plug. Under-worksurface mounting bracket models work with any top that has a 5" x 5" square clearance. Worksurface clamp models work on any top with a 4" overhang. UL Listed. <p>! Color finish coordinates with HON's Charcoal or White. <i>Specify STRM for Storm and SNW for Snow when ordering. Example: HPWRMOD3WC.STRM</i></p> | <p>HPWRMOD3WC </p> <p>HPWRMOD3UWM</p> <p>HPWRMOD2WC </p> <p>HPWRMOD2UWM</p> | <p>2.3 </p> <p>2.3 </p> <p>2.3 </p> <p>2.3 </p> | <p>0.2</p> <p>0.2</p> <p>0.2</p> <p>0.2</p> | <p>\$342</p> <p>\$342</p> <p>\$546</p> <p>\$546</p> |
|  Model HPWRMOD3WC shown | | | | | |
|  Model HPWRMOD2UWM shown | | | | | |
|   | <p>Under Worksurface Power Module — 4 Outlets, 10' Cord</p> <ul style="list-style-type: none"> Includes 10' cord with three-prong plug. Fits in cable management troughs. See page 613. 4 outlets on side create easy access. <p>NOTES: Power Modules will also work with standing-height applications for 10500 Series™ and Voi® desks.</p> <p>! Available in black finish only, no specification needed.</p> | HPWRMOD2 | 1.5 | 0.2 | \$441 |
|   | <p>Vertebrae</p> <p>NOTES: 30"H x 3 1/8"W x 1 1/2"D. Ships unassembled.</p> <p>! Clear finish. Specify "X" for finish option.</p> <p>SPECIFYING EXAMPLE: HMPVWM28.X</p> | HMPVWM28 | 3.0 | 0.3 | \$246 |

NOTES:

- For additional information see the Workplace Tools section in the 2021 Shared Spaces Pricer.

SYSTEMS

Accessories — Monitor Arms

OPEN MARKET EXCEPT AS NOTED



Icon Legend on page 19

WORKSTATIONS

DESCRIPTION

MODEL SHIP WEIGHT CUBE LIST PRICE

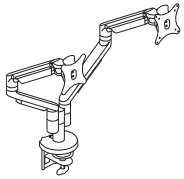

Dual Dynamic Monitor Arm

- 150° of rotation at base with optional 360° rotation.
- Arms extend 22" and retract up to 3".
- Monitor mount rotates 180° and tilts +/-30°.
- Monitor can be rotated from landscape to portrait position.

! Arms hold monitors from 6.2-18 lbs. Optional counterweight HPACW available to support monitors as low as 5 lbs. (see the Workplace Tools section in the 2021 Shared Spaces Pricer).

HMASD 17.0 1.1 \$962

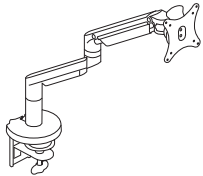

Single Dynamic Monitor Arm

- 180° of rotation at base with optional 360° rotation.
- Arms extend 22" and retract up to 3".
- Monitor mount rotates 180° and tilts +/-30°.
- Monitor can be rotated from landscape to portrait position.

! Arms hold monitors from 6.2-18 lbs. Optional counterweight HPACW available to support monitors as low as 5 lbs. (see the Workplace Tools section in the 2021 Shared Spaces Pricer).

HMASTS 11.5 0.8 \$501

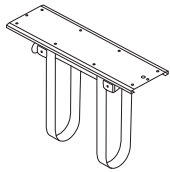

360° Swivel CPU Holder with Adjustable Straps

- Supports CPUs 3 3/4" wide up to 64" perimeter and holds up to 75 lbs.
- 360° rotation.
- Ships complete and includes necessary mounting hardware and instruction sheet.

! Available in Black only, no specification needed.

HCPUI 7.0 0.2 \$260

SIN 33721

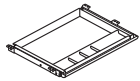

Polymer Center Drawer

- Color: Black.
- Material: ABS.
- Minimum clearance for mounting: 23"W x 16 1/4"D x 2"H.
- Retracts on 16" ball-bearing slides.
- Can be used on worksurfaces with Coordinate™ Height Adjustable Bases as long as it is attached with spacer model HKBS.
- Can store up to 25 lbs.

! Black finish only, no specification needed.

HCD1 7.0 0.5 \$126

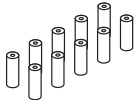

Keyboard Spacer

- For use when attaching a keyboard tray to Coordinate™ and Voi® or Systems Worksurface with an external channel.
- The kit includes ten cylinder spacers and ten screws.
- Spacers are 3/4"W x 2 1/8"H.
- Specify one kit per keyboard tray.

NOTES: For additional information see the Workplace Tools section in the 2021 Shared Spaces Pricer.

HKBS 1.0 0.8 \$100

NOTES:

- See the Workplace Tools section in the 2021 Shared Spaces Pricer for additional monitor arm models.

HOW TO SPECIFY

| | |
|-----------------------------------|--|
| <p>Select Model Number</p> | <p>Select Finish</p> <p><i>Specify for models HMASD and HMASTS only</i></p> <p>SVR Silver BLK Black</p> |
| <p>H M A S D .</p> | <p>S V R</p> |

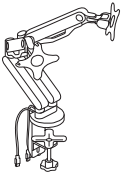

| | DESCRIPTION | MODEL | SHIP WEIGHT | CUBE | LIST PRICE |
|---|--|-----------------|-------------|------|--------------|
|  | <p>Coordinate™ Portable Desktop Riser 31"D x 5"-16½"H x 35"W</p> <p>NOTES: Available in Black (BLK) or White (WHT) finish. Desktop riser dimensions (without keyboard tray): 22"D x 5"-16½"H x 35"W. Keyboard tray dimensions: 9"D x 30"W. Max loading capacity is 33 lbs for the desktop riser surface and 4 lbs for the keyboard tray. Easily transition from seated to standing positions throughout the workday. Sits atop an existing desk to create sit-to-stand functionality by raising the computer. Includes keyboard tray and surface for computer monitors. HON 5-Year Limited Warranty.</p> <p>⚠ Not intended for use on mobile workstations.</p> | HBXRISER | 54.0 | 4.1 | \$657 |
|  | <p>Dual Monitor Arm with 2 USB Ports</p> <p>NOTES: Easy adjustment. Height adjusts to 17" tall. Monitor tilt and swivel capability. Enclosed cable management. Grommet or desktop mounting. Clean appearance. In some applications the Monitor Arms may extend 12 or more inches into the worksurface. For additional information see the Workplace Tools section in the 2021 Shared Spaces Pricer. HON 5-Year Limited Warranty.</p> <p>⚠ No specification needed.</p> <p>⚠ Cannot be used with Empower® height adjustable models.</p> | HBDMAUSB | 41.9 | 2.6 | \$410 |

HOW TO SPECIFY

| | |
|--|---|
| <p>Select Model Number</p> <p>H B X R I S E R .</p> | <p>Select Finish</p> <p>BLK Black WHT White</p> <p>B L K</p> |
|--|---|

SYSTEMS

Accessories

OPEN MARKET



Icon Legend on page 19

WORKSTATIONS

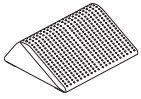

DESCRIPTION

Footrest — Anti-Slip Cover
13¾"D x 5½"H x 16"W

ⓘ Available in Black (T) finish ONLY. Recommended weight capacity not to exceed 250 pounds. **HON 5-Year Limited Warranty.**
SPECIFYING EXAMPLE: HVL991.T — isolated, dedicated circuit

MODEL

HVL991

SHIP WEIGHT

7 Ⓞ

CUBE

0.9

LIST PRICE

\$89

HOW TO SPECIFY

| | |
|--|---|
| <p>Select Model Number</p> <p>H V L 9 9 1 .</p> | <p>Select Finish</p> <p>T Black</p> <p>T</p> |
|--|---|



Versé® Panels shown with SmartLink® Value Mobile Storage, Between™ Multi-Purpose Table, Motivate® Stacking Chair, and Hand Sanitizer Station.

VERSÉ®

Create more personal space in open areas with the Versé panel system. Easily connected and endlessly reconfigurable, Versé panels can maintain sightlines or maximize privacy, and keep frequently used items conveniently within reach. It's the smart long-term investment to support short-term work environments that are constantly changing.



FEATURES

- A variety of Versé panel widths and heights easily connect to one another to form workstations or offer privacy as space dividers. Available in sizes ranging from 24"-72"W and 42"-72"H.
- Steel hanging shelf hangs off the top of a Versé panel.
- Choose from three paint options to customize your office space.

VERSÉ® Panel System

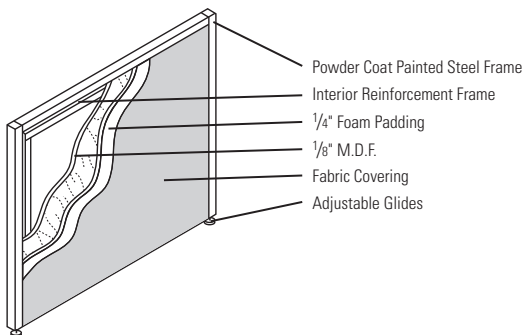
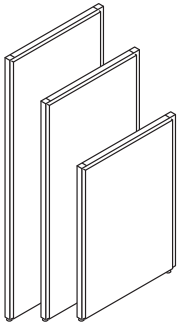
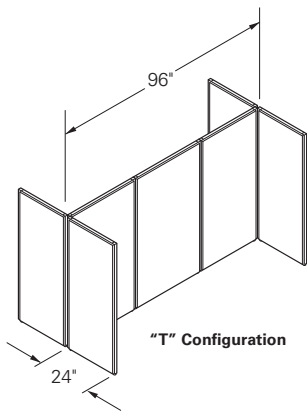
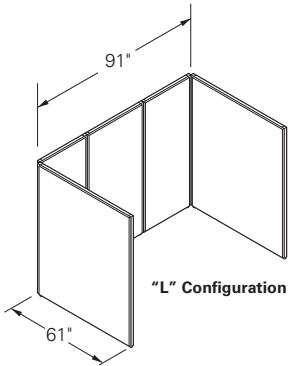

FEATURES

Panels

- Use Versé as a privacy panel (stand-alone) to create space division.

QuickConnect

(See page 649 for more details on this hardware.)

- Our QuickConnect connectors allow for easy installation. Simply snap on the connectors at the top and bottom of the panel and slide the panels together. There are only two connectors to specify for almost all configurations.

Storage

- Shelving capabilities. Each shelf width must match width of panel.

PANEL DIMENSIONS AND GROWTH ALLOWANCES

- All panel runs must be supported at each end of the panel run and supported at least every 8' within the panel run (maximum of 8' between supports).
- Support can be in the form of an adjustable wall bracket or return panel at 90° to the run.
- When using an "L" configuration, the return panel must measure at least 60% (minimum 36") of the unsupported run.
- When using a "T" configuration, each return panel must measure at least 20% of the unsupported run.
- Return panels can be no more than 24" lower than the panel height in the unsupported run.
- When used in conjunction with hanging shelves, panel width must match width of shelf.

VERSÉ PANELS

Includes

- Adjustable glides with all panels.

What Do I Need?

- QuickConnect Connectors.

Special Notes

- Versé panels feature a soft, padded look.
- Panels packed two per carton when possible.

| Connection Type | Connectors Needed |
|-----------------|-------------------|
| Straight | 1 pair – 180° |
| 2-way (L) | 1 pair – 90° |
| 3-way (T) | 2 pair – 90° |
| 4-way (X) | 3 pair – 90° |

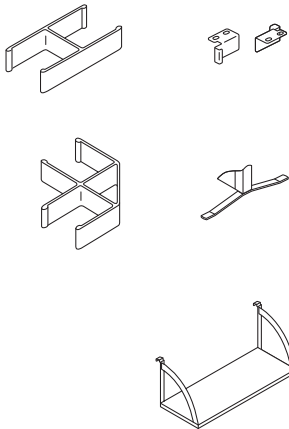

CONNECTING HARDWARE

Versé QuickConnect User Instructions

- Versé QuickConnect is easy to install. Simply snap on the connectors at the top and bottom of the panel and slide the panels together. There are only two connectors to specify for almost all configurations, including multi-height connections.
- 180° Straight Connector – use when connecting two panels together for a straight connection or for multi-height straight connections.
- 90° Corner Connector – use for 2-way, 3-way and 4-way corner connections. Only one pair is needed per corner connection or for multi-height corner connections.

HARDWARE

Special Notes

- Connectors add to the overall dimensions of the panel installation.
- These connector dimensions are important when space planning and sizing your panel layout.
- All hardware items may ship by a parcel service.
- Use HBV-PBS bracket with freestanding furniture for optimal workstation rigidity.

SHELVES

- Steel shelves are 14½" high.
- End brackets included.
- Must match panel width.
- Easy assembly; no tools required.

PANEL FABRIC & PAINT ORDERING CODES

| PRICE CODE A | |
|--------------|------|
| CENTURION* | CU |
| ◆ Apricot | CU47 |
| ◆ Bark | CU25 |
| ◆ Black | CU10 |
| ◆ Espresso | CU49 |
| ◆ Fog | CU03 |
| ◆ Frost | CU22 |
| ◆ Goldenrod | CU27 |
| ◆ Indigo | CU06 |
| ◆ Iris | CU50 |
| ◆ Iron Ore | CU19 |
| ◆ Jade | CU83 |
| ◆ Marsala | CU63 |
| ◆ Morel | CU24 |
| ◆ Navy | CU98 |
| ◆ Peacock | CU97 |
| ◆ Pear | CU84 |
| ◆ Ruby | CU67 |
| ◆ Sapphire | CU09 |

| PRICE CODE A <i>continued</i> | |
|-------------------------------|-------|
| CONTOURETT POLYURETHANE* | VUR |
| ◆ Baltic | VUR94 |
| ◆ Beach | VUR23 |
| ◆ Black | VUR10 |
| ◆ Bordeaux | VUR63 |
| ◆ Buff | VUR22 |
| ◆ Cloud | VUR18 |
| ◆ Coffee Bean | VUR49 |
| ◆ Crater | VUR51 |
| ◆ Flame | VUR62 |
| ◆ Graphite | VUR19 |
| ◆ Iron | VUR20 |
| ◆ Luggage | VUR26 |
| ◆ Marine | VUR92 |
| ◆ Navy | VUR95 |
| ◆ Nimbus | VUR93 |
| ◆ Ocean | VUR96 |
| ◆ Pumpkin | VUR42 |

| PRICE CODE A <i>continued</i> | |
|-------------------------------|-------|
| CONTOURETT POLYURETHANE* | VUR |
| ◆ Quarry | VUR24 |
| ◆ Red | VUR64 |
| ◆ Safari | VUR27 |
| ◆ Sage | VUR82 |
| ◆ Steel | VUR21 |
| ◆ Storm | VUR17 |
| ◆ Taupe | VUR28 |
| ◆ Trunk | VUR50 |

| PRICE CODE A <i>continued</i> | |
|-------------------------------|---------|
| SEAWAY | 2310 |
| ◆ Grey | 2310GRE |

| PAINTS ORDERING CODES (Panel, T-base, Shelf and Connectors) | |
|--|----------|
| Black | P |
| Light Gray | Q |
| Putty | L |

* Centurion and Contourett fabrics are only able to exceed 54" in one direction (vertically or horizontally), not both directions.

! To clean Versé Panels with Contourett use a 1:5 diluted bleach and water mixture or Virex II 256. Leave cleaning solution on for at least 30 seconds but no longer than two minutes. Thoroughly remove the solution from the surface with a clean cloth and warm water. May cause discoloration if left on the surface longer than the suggested time or not removed after sanitizing.

◆◆◆ For lead time information see page 19.

VERSÉ® Panel System

OPEN MARKET

WORKSTATIONS

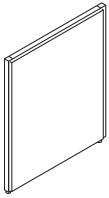

DESCRIPTION

42" H Panel

42" H x 24" W
42" H x 30" W
42" H x 36" W
42" H x 42" W
42" H x 48" W
42" H x 60" W
42" H x 72" W

MODEL

HBV-P4224
HBV-P4230
HBV-P4236
HBV-P4242
HBV-P4248
HBV-P4260
HBV-P4272

SHIP WEIGHT

18
22
24
33
34
36
48

CUBE

1.8
2.2
2.7
3.1
3.6
4.4
5.3

LIST PRICE

\$339
\$351
\$356
\$358
\$374
\$402
\$462

NOTES: All panels include adjustable glides.

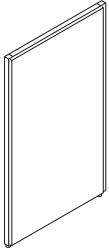

60" H Panel

60" H x 24" W
60" H x 30" W
60" H x 36" W
60" H x 42" W
60" H x 48" W
60" H x 60" W
60" H x 72" W

HBV-P6024
HBV-P6030
HBV-P6036
HBV-P6042
HBV-P6048
HBV-P6060
HBV-P6072

30
33
35
37
42
54
60

2.5
3.2
3.8
4.4
5.0
6.4
7.5

\$376
\$390
\$391
\$410
\$416
\$434
\$508

NOTES: All panels include adjustable glides.

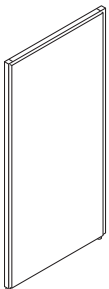

72" H Panel

72" H x 24" W
72" H x 30" W
72" H x 36" W
72" H x 42" W
72" H x 48" W
72" H x 60" W

HBV-P7224
HBV-P7230
HBV-P7236
HBV-P7242
HBV-P7248
HBV-P7260

39
40
44
46
50
62

3.0
3.8
4.5
5.2
6.0
7.5

\$423
\$432
\$453
\$474
\$485
\$537

NOTES: All panels include adjustable glides.

NOTES:

- **HON 5-Year Limited Warranty.**
- Panels offer privacy as room dividers or in desk-wrap applications.
- Panels feature 1" powder coat painted steel frame construction with interior reinforcement, 1/4" foam padding and 1/8" M.D.F.
- All panels include adjustable glides.
- To free-stand a single Versé panel or to stabilize the end of a panel run, order T-base stabilizing foot shown on page 649.
- See page 647 for available fabrics and finishes.

HOW TO SPECIFY

Select
Model Number

Select
Upholstery

See page 647

Select
Trim Color

P Black
Q Light Gray
L Putty





See page 647

HBV - P4224 .

2310GRE .

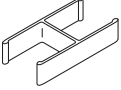
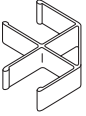
P

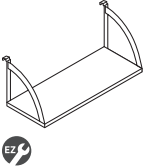

| | DESCRIPTION | MODEL | SHIP WEIGHT | CUBE | LIST PRICE |
|--|---|--|---|--|--|
|  | 180° QuickConnect Straight Panel Connector Pair NOTES: 180° connector to be used to connect two panels in a straight connection or for multi-height straight connections. | HBV-QC180 | 0.1 | 0.3 | \$27 |
|  | 90° QuickConnect Panel Connector Pair NOTES: 90° connector to be used for 2-way, 3-way or 4-way corner connections, or for multi-height connections. | HBV-QC90 | 0.1 | 0.3 | \$27 |
|  | Wall Bracket | HBV-PWB1 | 0.2 | 0.3 | \$58 |
|  | Panel-to-Worksurface Bracket Pair | HBV-PBS | 0.3 | 0.3 | \$49 |
|  | T-Base Stabilizing Foot 18¾" long NOTES: Adds 1¼" to the height of the panel. | HBV-TBASE | 6.0 | 0.3 | \$53 |
|  | Hanging Shelves 24"W x 12¾"D 30"W x 12¾"D 36"W x 12¾"D 42"W x 12¾"D 48"W x 12¾"D 60"W x 12¾"D NOTES: Shelves hang over the top of panels. Supporting panel must match the width of the shelf. | HBV-VSH24 HBV-VSH30 HBV-VSH36 HBV-VSH42 HBV-VSH48 HBV-VSH60 | 9.0 10.0 12.0 13.0 14.0 19.0 | 1.2 1.5 1.8 2.0 2.3 2.9 | \$216 \$240 \$262 \$282 \$323 \$367 |

NOTES:

- **HON 5-Year Limited Warranty.**
- T-base stabilizing foot optional.
- Extruded aluminum connectors are sold in pairs and are used at top and bottom of panels.
- Shelves hang over the top of panels; the supporting panel must match the width of the shelf.
- Shelves feature steel construction with powder coat paint finish.
- Shelves ship easy to assemble – no tools required.
- See page 647 for available fabrics and finishes.

HOW TO SPECIFY

| | |
|--|--|
| <p>Select Model Number</p> <p>HBV - QC180</p> | <p>Select Trim Color</p> <p>See page 647</p> <p>P</p> |
|--|--|

OVERVIEW OF PERSONAL STORAGE AND PEDESTALS

LATERAL FILES

Advantages:

a) The most efficient means of conventional filing; b) Ideal for active filing in workstations, where higher volume capacity is necessary and retrieval is frequent

Considerations:

2-drawer steel lateral files fit under standard-height worksurfaces when using panel systems.

VERTICAL FILES

Advantages:

a) Economical; b) The most widely used filing method; c) requires minimal floor space

Considerations:

Vertical files are best suited for long-term storage, where retrieval is less frequent. For larger banks of files, lateral files are more space-efficient than vertical files.

BOOKCASES

Advantages:

a) These units are ideal for binders, reference books or other items; b) Available with your choice of fixed or movable shelves

Considerations:

If working with panel systems, it is more attractive to specify units that are lower than the panel height.

FILING TECHNIQUES

| Type | Standing Files | Hanging Files |
|----------------|--|---|
| Advantages | Inexpensive. Uses existing file folders. | Easier organization and identification of the file folders. Files viewed from top. Remaining files hold their place when folders are removed. Easier to re-stock. |
| Requirements | Follower block or Dividers | Hangrails or high-drawer sides |
| Can be used in | <ul style="list-style-type: none"> Vertical files (front-to-back only) Lateral files (side-to-side only in drawers) Shelf files (side-to-side only) | <ul style="list-style-type: none"> Vertical files (front-to-back only) Lateral files (front-to-back or side-to-side in drawers) |

Contain*/Flagship*/Brigade* Series Pedestals Utilization with 38000 Series.

| Pedestal Depths | Abound* and Accelerate* Panel-Hung Worksurfaces | | | 38000 Series Modular Desks | | |
|---------------------------------------|---|----------|----------|----------------------------|----------|----------|
| | 18" Deep | 24" Deep | 30" Deep | 24" Deep | 30" Deep | 36" Deep |
| 16 ³ / ₄ " Deep | • | • | • | • | • | • |
| 22 ⁷ / ₈ " Deep | | • | • | •* | • | • |
| 28 ⁷ / ₈ " Deep | | | • | | • | • |

* Cannot attach 22⁷/₈"D Hanging Pedestal.

WORKING WITH STORAGE PEDESTALS

Storage Pedestals are available in 5 styles:

- Box/File Mobile.....(Model Nos. beginning with HSPM)
- Freestanding(Model Nos. beginning with HSPF)
- Hanging(Model Nos. beginning with HSPH)
- Worksurface Supporting**(Model Nos. beginning with HSPS)
- Under Worksurface Mobile.....(Model Nos. beginning with HSPM)

Worksurface height supporting pedestals have a taller base plate, resulting in a taller overall cabinet height. Consideration must be made to ensure that units align visually with each other. The accompanying chart will help you select the correct pedestal for your application.

| Pedestal Models (Nos. begin with) | Style | Overall Height | Base Height | Spacer Required Below Worksurface |
|-----------------------------------|--------------------------|----------------------------------|---------------------------------|-----------------------------------|
| HSPM or H15 | Box/File mobile | 22 ⁵ / ₈ " | N/A | N/A |
| HSPF | Freestanding | 28" | 3 ¹ / ₂ " | NO |
| HSPH or H14 | Hanging | 19 ¹ / ₂ " | N/A | N/A |
| HSPS or H19 or H36 | Worksurface supporting** | 28" | 3 ¹ / ₈ " | NO |
| HSPM or H18 or H33 | Under Worksurface mobile | 28" | 3 ¹ / ₈ " | NO |

** Units will support conventional 29¹/₂"H worksurfaces, WITHOUT SPACERS.

LATERAL FILING OPTIONS

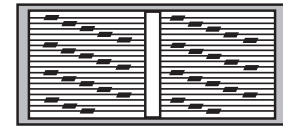

Front-to-back filing:

30" wide files*: 30¹/₂" of filing with letter/letter rows.

36" wide files*: 30¹/₂" of filing with letter/letter, legal/legal, or letter/legal rows.

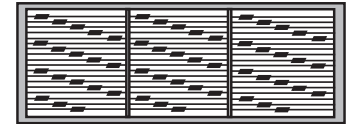

42" wide files**: 45³/₄" of filing with 3 rows letter or 30¹/₂" of 2 rows legal, or 2 standard printout rows.

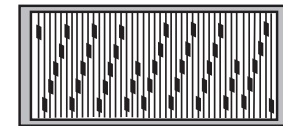

Side-to-side filing:

30" wide files: 27" of filing with letter or legal.

36" wide files: 33" of filing with letter or legal.

42" wide files: 39" of filing with letter or legal.

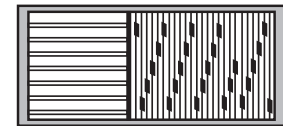

Combination filing:

(front-to-back with side-to-side in one drawer)

30" wide files: not recommended.

36" wide files: 15¹/₄" of front-to-back filing and 20¹/₄" of side-to-side legal filing.

42" wide files: 15¹/₄" of front-to-back filing and 26¹/₄" of side-to-side legal filing.

* Requires H919491 optional hangrails.

** Requires H919492 optional hangrails.

HON LATERAL FILES AT A GLANCE

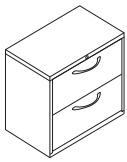

Flagship®

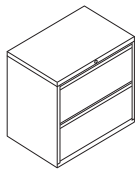

**Brigade®
Model H872L**

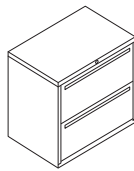

**Brigade®
Model H772L**

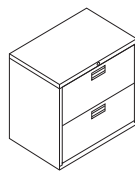

**Brigade®
Model H672L**

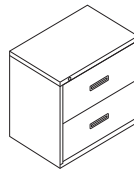

400 Series

Flagship Series lateral files are 18"D.

Brigade® 800, 700, 600 and 500 Series lateral files are all 18"D.

| Series | Widths Available | Heights Available | Suspension Style | Usage | Pull | Safety Interlock | Lock | Features |
|---|-------------------|----------------------------------|---------------------------------------|-----------|--|---------------------|----------------|---|
| Flagship, Brigade® 800, 700, 600 | 30" 36" 42" | 2 dwr 3 dwr 4 dwr 5 dwr | Heavy-Duty ball-bearing (telescoping) | Intensive | Flagship Series 3 Pulls available. See page 653. Brigade® 800 Series Full-width radius designer style Brigade® 700 Series Full-width designer style Brigade® 600 Series Anodized Aluminum | Positive Mechanical | Core removable | <ul style="list-style-type: none"> • 4 leveling glides • 2 hangrails per drawer • Rack resistant case reinforcement • Flagship® and Brigade® can be used with Storage Islands |
| 400 | 30" 36" | 2 dwr 4 dwr | Ball-bearing | Moderate | Color-matched polymer Monochromatic drawer pulls | Positive Mechanical | Core removable | <ul style="list-style-type: none"> • 2 leveling glides |

All products meet or exceed ANSI/BIFMA and ISTA performance standards.

STORAGE

HON VERTICAL FILES AT A GLANCE

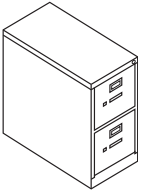

Model H212

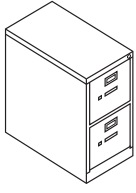

Model H312



Model H512

Vertical files listed below meet or exceed ANSI/BIFMA and ISTA performance standards. They are available in 15"W letter and 18¼"W legal widths.

| Series | Depth | Heights Available | Suspension Style | Lock | Accepts Hanging Files | Features |
|-------------------|-------|-------------------------|---|-----------------------------------|-------------------------------------|---------------------------------|
| 210 Series | 28½" | 2 dwr 4 dwr 5 dwr | Three-part telescoping, ball-bearing steel suspension | INCLUDED core removable | YES (Hangrails not required) | Follower Block standard |
| 310 Series | 26½" | 2 dwr 4 dwr 5 dwr | Three-part telescoping, ball-bearing steel suspension | INCLUDED core removable | YES (Hangrails not required) | Follower Block standard |
| 510 Series | 25" | 2 dwr 4 dwr | Three-part telescoping, ball-bearing steel suspension | INCLUDED core removable | YES (Hangrails not required) | Adjustable wire follower |

STORAGE

STORAGE AND FILES ORDERING INFORMATION

CONTAIN® PRODUCT

L1 LAMINATES CODES

Woodgrain

- ◆ Bourbon Cherry H
- ◆ Cognac COGN
- ◆ Florence Walnut LFW1
- ◆ Harvest C
- ◆ Kingswood Walnut LK11
- ◆ Mahogany N
- ◆ Mocha MOCH
- ◆ Natural Maple D
- ◆ Pinnacle PINC
- ◆ Shaker Cherry F
- ◆ Sterling Ash LSA1

L2 LAMINATES CODES

Woodgrain

- ◆ Lowell Ash LLA1
- ◆ Natural Recon LNR1
- ◆ Phantom Ecru LPE1
- ◆ Portico Teak LPT1
- ◆ Skyline Walnut LSW1

OPTIONAL LAMINATE TOPS FOR LATERAL FILES AND CONTAIN® CREDENZAS

L1 LAMINATES CODES

Woodgrain

- ◆ Bourbon Cherry H
- ◆ Cognac COGN
- ◆ Florence Walnut LFW1
- ◆ Harvest C
- ◆ Kingswood Walnut LK11
- ◆ Mahogany N
- ◆ Mocha MOCH
- ◆ Natural Maple D
- ◆ Pinnacle PINC
- ◆ Shaker Cherry F
- ◆ Sterling Ash LSA1

Solid

- ◆ Charcoal S
- ◆ Designer White LDW1
- ◆ Loft LOFT

Patterned

- ◆ Handspun Chestnut LAHC
- ◆ Handspun Dove LAHD
- ◆ Handspun Pearl LAHP
- ◆ Handspun Slate LAHS
- ◆ Sheer Mesh* A5
- ◆ Silver Mesh* B9
- ◆ Steel Mesh* A9
- ◆ Canyon Zephyr* K9
- ◆ Desert Zephyr* K8
- ◆ Shadow Zephyr* K1
- ◆ Gray* G2
- ◆ White* G1

L2 LAMINATES CODES

Woodgrain

- ◆ Lowell Ash LLA1
- ◆ Natural Recon LNR1
- ◆ Phantom Ecru LPE1
- ◆ Portico Teak LPT1
- ◆ Skyline Walnut LSW1

OPTIONAL LAMINATE TOPS FOR STEEL BOOKCASES

L1 LAMINATES CODES

Woodgrain

- ◆ Bourbon Cherry H
- ◆ Florence Walnut LFW1
- ◆ Harvest C
- ◆ Kingswood Walnut LK11
- ◆ Mahogany N
- ◆ Natural Maple D
- ◆ Shaker Cherry F
- ◆ Sterling Ash LSA1

Solid

- ◆ Charcoal S
- ◆ Designer White LDW1

Patterned

- ◆ Handspun Chestnut LAHC
- ◆ Handspun Dove LAHD
- ◆ Handspun Pearl LAHP
- ◆ Handspun Slate LAHS
- ◆ Sheer Mesh* A5
- ◆ Silver Mesh* B9
- ◆ Steel Mesh* A9
- ◆ Canyon Zephyr* K9
- ◆ Desert Zephyr* K8
- ◆ Shadow Zephyr* K1
- ◆ Gray* G2
- ◆ White* G1

1870 SERIES BOOKCASES

L1 LAMINATES CODES

Woodgrain

- ◆ Cognac COGN
- ◆ Harvest C
- ◆ Mahogany N

FLAGSHIP®, CONTAIN® PRODUCT, BRIGADE PEDESTALS, BRIGADE 800, 700, 600 LATERAL FILES, 210, 310/H320, AND 510 SERIES VERTICAL FILES, BRIGADE STORAGE CABINETS, BRIGADE STEEL BOOKCASES

PAINTS CODES

P1

- ◆ Black P
- ◆ Brownstone P7D
- ◆ Charcoal S
- ◆ Designer White PJW
- ◆ Fossil P28
- ◆ Greige T5
- ◆ Light Gray Q
- ◆ Loft LOFT
- ◆ Muslin T3
- ◆ Putty L
- ◆ Shadow* SHDW
- ◆ Titanium P8T

P2

- ◆ Champagne Metallic T4
- ◆ Platinum Metallic T1
- ◆ Silver** PR6
- ◆ Solar Black** P8X

400 SERIES LATERAL, FLAMESAFE FILES

PAINTS CODES

P1

- ◆ Black P
- ◆ Light Gray Q
- ◆ Loft LOFT
- ◆ Putty L

PULL OPTIONS FOR CONTAIN® AND FLAGSHIP® STORAGE

Suffix "A"



Satin Chrome Arch Pull

Suffix "N"



Full Face Integral Drawer Pull

Suffix "R"



Full Radius Drawer Pull

NOTES: Arch pulls available in Satin Chrome only.

* Laminate colors will have the following pre-set edgeband colors:

** Only available on Flagship® Pedestals and Contain®.

| | |
|-------------|----------|
| Laminate | Edge |
| Sheer Mesh | Muslin |
| Silver Mesh | Loft |
| Steel Mesh | Charcoal |
| Gray | Charcoal |
| White | Charcoal |

Edgeband matches top except as noted.

For Champagne Metallic Paint, Muslin is the suggested edgeband color. When Champagne Metallic Paint is selected, pulls are standard in Muslin.

- The HON Company has elected to discontinue the HON Choice paint program, as of 12/31/2018, and roll it into our standard specials process.
- A special request will need to be submitted to receive pricing and order information.

◆◆◆ For lead time information see page 19.

* De-emphasized



Brigade® Storage.

BRIGADE®

You don't need an army to bring order to your office. Just a brigade. Sturdily built to rigorous specifications, our Brigade storage is ready to serve any organization needing top-quality storage. With welded construction and features like heavy-duty steel ball-bearing suspensions, it outlasts and outperforms most build-it-yourself options. Brigade was built to soldier on.



FEATURES

- Clean, straightforward design complements and blends in with any workspace.
- Optional Storage Islands laminate tops provide extra surface area for technology tools, collating or stand-up work.
- With a combination of reasonable pricing and high quality, Brigade is a value that's hard to beat.
- Heavy-duty Steel ball-bearing drawer suspensions operate easily and quietly.
- Mechanical interlock prevents more than one drawer from being opened at a time, for stability.

BRIGADE® ORDERING INFORMATION

BRIGADE PRODUCTS

PAINTS CODES

P1

- ◆ Black P
- ◆ Brownstone P7D
- ◆ Charcoal S
- ◆ Designer White PJW
- ◆ Fossil P28
- ◆ Greige T5
- ◆ Light Gray Q
- ◆ Loft LOFT
- ◆ Muslin T3
- ◆ Putty L
- ◆ Shadow * SHDW
- ◆ Titanium P8T

P2

- ◆ Champagne Metallic T4
- ◆ Platinum Metallic T1

OPTIONAL LAMINATE TOPS FOR LATERAL FILES AND CONTAIN® CREDENZAS

L1 LAMINATES CODES

Woodgrain

- ◆ Bourbon Cherry H
- ◆ Cognac COGN
- ◆ Florence Walnut LFW1
- ◆ Harvest C
- ◆ Kingswood Walnut LK11
- ◆ Mahogany N
- ◆ Mocha MOCH
- ◆ Natural Maple D
- ◆ Pinnacle PINC
- ◆ Shaker Cherry F
- ◆ Sterling Ash LSA1

Solid

- ◆ Charcoal S
- ◆ Designer White LDW1
- ◆ Loft LOFT

Patterned

- ◆ Handspun Chestnut LAHC
- ◆ Handspun Dove LAHD
- ◆ Handspun Pearl LAHP
- ◆ Handspun Slate LAHS
- ◆ Sheer Mesh* * A5
- ◆ Silver Mesh* B9
- ◆ Steel Mesh* * A9
- ◆ Canyon Zephyr * K9
- ◆ Desert Zephyr * K8
- ◆ Shadow Zephyr * K1
- ◆ Gray* G2
- ◆ White* G1

L2 LAMINATES CODES

Woodgrain

- ◆ Lowell Ash LLA1
- ◆ Natural Recon LNRI
- ◆ Phantom Ecru LPE1
- ◆ Portico Teak LPT1
- ◆ Skyline Walnut LSW1

For Champagne Metallic Paint, Muslin is the suggested edgeband color.

- The HON Company has elected to discontinue the HON Choice paint program, as of 12/31/2018, and roll it into our standard specials process.
- A special request will need to be submitted to receive pricing and order information.

* Laminate colors will have the following pre-set edgeband colors:

| Laminate | Edge |
|-------------|----------|
| Sheer Mesh | Muslin |
| Silver Mesh | Loft |
| Steel Mesh | Charcoal |
| Gray | Charcoal |
| White | Charcoal |

Edgeband matches top except as noted.

◆◆◆ For lead time information see page 19.

* De-emphasized





BRIGADE® Standard Height Pedestals

GSA SIN 33721

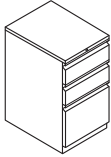

Icon Legend on page 19

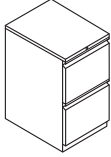
STORAGE

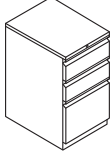
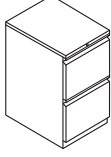
| | DESCRIPTION | MODEL | SHIP WEIGHT | CUBE | LIST PRICE BY PAINT GRADE | | |
|---|--|--|-------------|------|---------------------------|--------------|--------------|
| | | | | | P1 | P2 | P3 |
|  | Standard Height Mobile Pedestals — Box/Box/File | | | | | | |
| | 15"W x 19 7/8"D x 28"H | H33720(?) | 73 | 6.6 | \$676 | \$704 | \$732 |
| | 15"W x 22 7/8"D x 28"H | H33723(?)  | 77 | 7.5 | \$696 | \$724 | \$752 |
|  | Standard Height Mobile Pedestals — File/File | | | | | | |
| | 15"W x 19 7/8"D x 28"H | H33820(?) | 73 | 6.6 | \$676 | \$704 | \$732 |
| | 15"W x 22 7/8"D x 28"H | H33823(?)  | 77 | 7.5 | \$696 | \$724 | \$752 |
|  | Standard Height Freestanding Support Pedestals — Box/Box/File | | | | | | |
| | 15"W x 19 7/8"D x 28"H | H36720(?) | 61 | 6.6 | \$663 | \$691 | \$719 |
| | 15"W x 22 7/8"D x 28"H | H36723(?) | 83 | 7.5 | \$687 | \$715 | \$743 |
|  | Standard Height Freestanding Support Pedestals — File/File | | | | | | |
| | 15"W x 19 7/8"D x 28"H | H36820(?) | 61 | 6.6 | \$663 | \$691 | \$719 |
| | 15"W x 22 7/8"D x 28"H | H36823(?) | 83 | 7.5 | \$687 | \$715 | \$743 |

NOTES:

- 28"H fits under all HON worksurfaces and desk shells.
 - Pencil tray standard in top box drawer.
 - One box divider standard in each box drawer.
 - One crossrail standard in each file drawer.
 - Ball-bearing suspension on file and box drawers with 90% extension.
 - File drawers have high sides for filing front-to-back.
 - See pages 750-751 for accessories and pedestal utilization information.
 - Equipped with HON "One Key" interchangeable core removable locks.
 - Front casters are fixed, rear casters swivel on mobile pedestals.
 - "N" Pull matches Brigade 700 Series lateral file pull.
 - "R" pull matches Brigade 800 Series Lateral Pull.
 - See pages 750-751 for Pedestal Accessories. Additional Flagship pedestal models on pages 707-708.
-  Freestanding support pedestals that are not positioned and attached under a worksurface, require a counterweight kit found on page 750.

HOW TO SPECIFY

| | | |
|---|--|--|
| <p>Select Model Number</p> <p>Select the Pull</p> <p>N Full Face Integral R Full Radius</p> <p>H 3 3 7 2 0 R</p> | <p>Select Lock Option</p> <p>L Lock</p> <p>L</p> | <p>Select Paint Color</p> <p>See page 655</p> <p>P</p> |
|---|--|--|



Icon Legend on page 19

BRIGADE® 800 SERIES

Lateral Files w/Drawers

| | DESCRIPTION | MODEL | SHIP WEIGHT | CUBE | LIST PRICE BY PAINT GRADE | | |
|--|--------------------------------|-------------|-------------|------|---------------------------|---------------|---------------|
| | | | | | P1 | P2 | P3 |
| | Lateral File — 2 Drawer | | | | | | |
| | 30"W x 18"D x 28"H | H872 | 121 | 12.2 | \$892 | \$925 | \$959 |
| | 36"W x 18"D x 28"H | H882 | 131 | 14.3 | \$996 | \$1029 | \$1063 |
| | 42"W x 18"D x 28"H | H892 | 141 | 16.7 | \$1152 | \$1185 | \$1219 |
| | Lateral File — 3 Drawer | | | | | | |
| | 30"W x 18"D x 39½"H | H873 | 158 | 16.4 | \$1267 | \$1300 | \$1334 |
| | 36"W x 18"D x 39½"H | H883 | 175 | 19.1 | \$1412 | \$1445 | \$1479 |
| | 42"W x 18"D x 39½"H | H893 | 190 | 22.4 | \$1637 | \$1670 | \$1704 |
| | Lateral File — 4 Drawer | | | | | | |
| | 30"W x 18"D x 52½"H | H874 | 197 | 21.4 | \$1534 | \$1601 | \$1667 |
| | 36"W x 18"D x 52½"H | H884 | 217 | 25.1 | \$1740 | \$1807 | \$1873 |
| | 42"W x 18"D x 52½"H | H894 | 232 | 29.4 | \$1998 | \$2065 | \$2131 |
| | Lateral File — 5 Drawer | | | | | | |
| | 30"W x 18"D x 64¼"H | H875 | 199 | 25.8 | \$2038 | \$2105 | \$2171 |
| | 36"W x 18"D x 64¼"H | H885 | 215 | 30.1 | \$2294 | \$2361 | \$2427 |
| | 42"W x 18"D x 64¼"H | H895 | 244 | 35.3 | \$2649 | \$2716 | \$2782 |

NOTES:

- 30", 36" & 42" case widths with drawers, 18" case depth.
- Flush top and sides.
- Reinforced case construction.
- Four adjustable leveling glides.
- Full-width radius designer style pull.
- Features drawer extension restraint; mechanical interlock inhibits the extension of more than one drawer at a time.
- Three-part, telescoping, steel ball-bearing suspension.
- Two adjustable hangrails per drawer for side-to-side filing.
- Counterweight included where applicable to meet ANSI/BIFMA stability requirements.
- Lock mechanism secures both sides of drawer.
- Baked enamel finish over rust-inhibiting phosphate pre-treatment.
- Equipped with HON "One Key" interchangeable core removable locks.
- Optional laminate tops and accessories — see page 747.
- See page 747 for Lateral File Accessories.

Keyed alike cores must be ordered separately — see page 773.

HOW TO SPECIFY

| | | |
|--------------------------------|---|---|
| Select Model Number | Select Lock Option L Lock | Select Paint Color See page 655 |
|--------------------------------|---|---|

BRIGADE® 800 SERIES Lateral Files w/Storage

GSA SIN 33721



Icon Legend on page 19

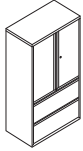

DESCRIPTION

Lateral File w/Storage — 2 Drawer

30"W x 18"D x 64¼"H

36"W x 18"D x 64¼"H

42"W x 18"D x 64¼"H

| MODEL | SHIP WEIGHT | CUBE | LIST PRICE BY PAINT GRADE | | |
|--------|-------------|------|---------------------------|--------|--------|
| | | | P1 | P2 | P3 |
| H875LS | 174 | 27.5 | \$1636 | \$1703 | \$1769 |
| H885LS | 210 | 32.9 | \$1802 | \$1869 | \$1935 |
| H895LS | 228 | 38.0 | \$2060 | \$2127 | \$2193 |

NOTES:

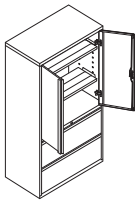

- 30", 36" & 42" case widths, 18" case depth.
- 46¼"H case - matches height of 800 Series 5 Drawer laterals.
- Bottom two openings are lateral drawers, remainder of case is storage shelves.
- Lateral file drawer features are same as 800 Series Laterals shown on previous page.
- Inside dimension of storage case is 36¼"H. Includes 2 adjustable shelves, adjustable in 2" increments. Bottom shelves accept two rows of 3-ring binders; top opening measures: 10¼".
- Storage case is standard with 2 hinged doors. Door pulls match lateral file drawer pulls.
- Equipped with HON "One Key" interchangeable core removable locks. Locks on storage case and lateral file are keyed alike. Lateral file drawers lock independently from storage case.
- Four adjustable leveling glides.
- See page 747 for Lateral File Accessories and page 662 for Wire Dividers.

STORAGE

HOW TO SPECIFY

| | | |
|---|--|--|
| <p>Select Model Number</p> <p>H 8 7 5 L S .</p> | <p>Select Lock Option</p> <p>L Lock</p> <p>L .</p> | <p>Select Paint Color</p> <p>See page 655</p> <p>T 1</p> |
|---|--|--|



BRIGADE® 700 SERIES

Lateral Files w/Drawers

| | DESCRIPTION | MODEL | SHIP WEIGHT | CUBE | LIST PRICE BY PAINT GRADE | | |
|--|---|-------------|-------------|------|---------------------------|---------------|---------------|
| | | | | | P1 | P2 | P3 |
| | Lateral File — 2 Drawer (locking) | | | | | | |
| | 30"W x 18"D x 28"H | H772 | 121 | 12.2 | \$892 | \$925 | \$959 |
| | 36"W x 18"D x 28"H | H782 | 131 | 14.3 | \$996 | \$1029 | \$1063 |
| | 42"W x 18"D x 28"H | H792 | 141 | 16.7 | \$1152 | \$1185 | \$1219 |
| | Lateral File — 3 Drawer (locking) | | | | | | |
| | 30"W x 18"D x 39 ¹ / ₈ "H | H773 | 158 | 16.4 | \$1267 | \$1300 | \$1334 |
| | 36"W x 18"D x 39 ¹ / ₈ "H | H783 | 175 | 19.1 | \$1412 | \$1479 | \$1545 |
| | 42"W x 18"D x 39 ¹ / ₈ "H | H793 | 190 | 22.4 | \$1637 | \$1670 | \$1704 |
| | Lateral File — 4 Drawer (locking) | | | | | | |
| | 30"W x 18"D x 52 ¹ / ₂ "H | H774 | 197 | 21.4 | \$1534 | \$1601 | \$1667 |
| | 36"W x 18"D x 52 ¹ / ₂ "H | H784 | 217 | 25.1 | \$1740 | \$1807 | \$1873 |
| | 42"W x 18"D x 52 ¹ / ₂ "H | H794 | 232 | 29.4 | \$1998 | \$2065 | \$2131 |
| | Lateral File — 5 Drawer (locking) | | | | | | |
| | 30"W x 18"D x 64 ¹ / ₄ "H | H775 | 199 | 25.8 | \$2038 | \$2105 | \$2171 |
| | 36"W x 18"D x 64 ¹ / ₄ "H | H785 | 215 | 30.1 | \$2294 | \$2361 | \$2427 |
| | 42"W x 18"D x 64 ¹ / ₄ "H | H795 | 244 | 35.3 | \$2649 | \$2716 | \$2782 |

NOTES: Top drawer is a roll-out shelf.

NOTES:

- 30", 36" & 42" case widths with drawers, 18" case depth.
- Flush top and sides.
- Reinforced case construction.
- Four adjustable leveling glides.
- Full-face integral drawer pulls.
- Features drawer extension restraint; mechanical interlock inhibits the extension of more than one drawer at a time.
- Three-part, telescoping, steel ball-bearing suspension.
- Two adjustable hangrails per drawer/rollout shelf for side-to-side filing.
- Counterweight included where applicable to meet ANSI/BIFMA stability requirements.
- Lock mechanism secures both sides of drawer.
- Baked enamel finish over rust-inhibiting phosphate pre-treatment.
- Optional laminate tops and accessories — see page 747.
- Equipped with HON "One Key" interchangeable core removable locks.
- See page 747 for Lateral File Accessories.

! Keyed alike cores must be ordered separately — see page 773.

HOW TO SPECIFY

| | | |
|--------------------------------|---|---|
| Select Model Number | Select Lock Option L Lock | Select Paint Color See page 655 |
|--------------------------------|---|---|

BRIGADE® 700 SERIES

Lateral Files w/Storage

GSA SIN 33721



Icon Legend on page 19

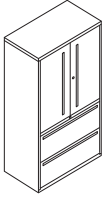

DESCRIPTION

Lateral File w/Storage — 2 Drawer

30"W x 18"D x 64¼"H

36"W x 18"D x 64¼"H

42"W x 18"D x 64¼"H

| MODEL | SHIP WEIGHT | CUBE | LIST PRICE BY PAINT GRADE | | |
|--------|-------------|------|---------------------------|--------|--------|
| | | | P1 | P2 | P3 |
| H775LS | 175 | 27.5 | \$1636 | \$1703 | \$1769 |
| H785LS | 211 | 32.9 | \$1802 | \$1869 | \$1935 |
| H795LS | 230 | 38.0 | \$2060 | \$2127 | \$2193 |

NOTES:

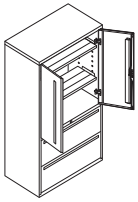

- 30", 36" & 42" case widths, 18" case depth.
- 64¼"H case - matches height of 700 Series 5 Drawer laterals.
- Bottom two openings are lateral drawers, remainder of case is storage shelves.
- Lateral file drawer features are same as 700 Series Laterals shown on previous page.
- Inside dimension of storage case is 36¼"H. Includes 2 adjustable shelves, adjustable in 2" increments. Bottom shelves accept two rows of 3-ring binders; top opening measures: 10¼".
- Storage case is standard with 2 hinged doors. Door pulls match lateral file drawer pulls.
- Equipped with HON "One Key" interchangeable core removable locks. Locks on storage case and lateral file are keyed alike. Lateral file drawers lock independently from storage case.
- Four adjustable leveling glides.
- See page 747 for Lateral File Accessories and page 662 for Wire Dividers.

STORAGE

HOW TO SPECIFY

Select Model Number

H 7 7 5 L S .

Select Lock Option

L Lock

L .

Select Paint Color









See page 655

T 1

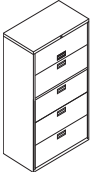

BRIGADE® 600 SERIES

Lateral Files w/Drawers



| | DESCRIPTION | MODEL | SHIP WEIGHT | CUBE | LIST PRICE BY PAINT GRADE | | |
|---|-----------------------------------|---|-------------|------|---------------------------|---------------|---------------|
| | | | | | P1 | P2 | P3 |
|  | Lateral File — 2 Drawer | | | | | | |
| | 30"W x 18"D x 28"H | H672 | 121 | 12.2 | \$823 | \$890 | \$956 |
| | 36"W x 18"D x 28"H | H682  | 131 | 14.3 | \$885 | \$918 | \$952 |
| | 42"W x 18"D x 28"H | H692 | 141 | 16.7 | \$1044 | \$1077 | \$1111 |
|  | Lateral File — 3 Drawer | | | | | | |
| | 30"W x 18"D x 39 $\frac{1}{8}$ "H | H673 | 158 | 16.4 | \$1129 | \$1196 | \$1262 |
| | 36"W x 18"D x 39 $\frac{1}{8}$ "H | H683  | 175 | 19.1 | \$1235 | \$1268 | \$1302 |
| | 42"W x 18"D x 39 $\frac{1}{8}$ "H | H693 | 190 | 22.4 | \$1451 | \$1484 | \$1518 |
|  | Lateral File — 4 Drawer | | | | | | |
| | 30"W x 18"D x 52 $\frac{1}{2}$ "H | H674 | 197 | 21.4 | \$1403 | \$1470 | \$1536 |
| | 36"W x 18"D x 52 $\frac{1}{2}$ "H | H684  | 217 | 25.1 | \$1533 | \$1600 | \$1666 |
| | 42"W x 18"D x 52 $\frac{1}{2}$ "H | H694 | 232 | 29.4 | \$1818 | \$1885 | \$1951 |
|  | Lateral File — 5 Drawer | | | | | | |
| | 30"W x 18"D x 64 $\frac{1}{4}$ "H | H675 | 199 | 25.8 | \$1864 | \$1931 | \$1997 |
| | 36"W x 18"D x 64 $\frac{1}{4}$ "H | H685  | 215 | 30.1 | \$1991 | \$2058 | \$2124 |
| | 42"W x 18"D x 64 $\frac{1}{4}$ "H | H695 | 244 | 35.3 | \$2402 | \$2469 | \$2535 |

NOTES:

- 30", 36" & 42" case widths with drawers, 18" case depth.
- Flush top and sides.
- Reinforced case construction.
- Four adjustable leveling glides.
- Features drawer extension restraint; mechanical interlock inhibits the extension of more than one drawer at a time.
- Three-part, telescoping, steel ball-bearing suspension.
- Two adjustable hangrails per drawer/roll-out shelf for side-to-side filing.
- Counterweight included where applicable to meet ANSI/BIFMA stability requirements.
- Lock mechanism secures both sides of drawer.
- Baked enamel finish over rust-inhibiting phosphate pre-treatment.
- Bright anodized aluminum recessed drawer pull.
- Equipped with HON "One Key" interchangeable core removable locks.
- Optional laminate tops and accessories — see page 747.
- See page 747 for Lateral File Accessories.

 Keyed alike cores must be ordered separately — see page 773.

HOW TO SPECIFY

| | | |
|---|--|--|
| Select Model Number  | Select Lock Option L Lock  | Select Paint Color See page 655  |
|---|--|--|

BRIGADE® Metal Dividers

GSA SIN 33721

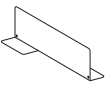
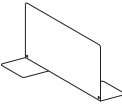

Icon Legend on page 19

| | DESCRIPTION | MODEL | SHIP WEIGHT | CUBE | LIST PRICE P1 |
|--|---------------------------|-----------------|-------------|------|------------------|
|  | Metal Box Divider | | | | |
| | 10 pack | HSCABD10 | 7 | 0.7 | \$189 |
| | 2 pack | HSCABD02 | 2 | 0.7 | \$48 |
| <p>! Metal dividers available in Black only. No need to specify.</p> | | | | | |
|  | Metal File Divider | | | | |
| | 10 pack | HSCAFD10 | 12 | 0.7 | \$224 |
| | 2 pack | HSCAFD02 | 3 | 0.7 | \$60 |
| <p>! Metal dividers available in Black only. No need to specify.</p> | | | | | |

STORAGE

HOW TO SPECIFY

Select
Model Number

H S C A B D 1 0



BRIGADE® Steel Bookcases

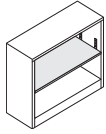

Shaded shelves are adjustable.

DESCRIPTION

Steel Bookcase
 34½"W x 12⅝"D x 29"H, 2-Shelf
 34½"W x 12⅝"D x 41"H, 3-Shelf
 34½"W x 12⅝"D x 59"H, 4-Shelf
 34½"W x 12⅝"D x 71"H, 5-Shelf
 34½"W x 12⅝"D x 81⅝"H, 6-Shelf

| MODEL | SHIP WEIGHT | CUBE | LIST PRICE BY PAINT GRADE | | |
|----------------|-------------|------|---------------------------|--------------|--------------|
| | | | P1 | P2 | P3 |
| HS30ABC | 44 | 9.6 | \$290 | \$323 | \$357 |
| HS42ABC | 57 | 13.3 | \$347 | \$380 | \$414 |
| HS60ABC | 77 | 18.9 | \$518 | \$585 | \$651 |
| HS72ABC | 87 | 22.6 | \$590 | \$657 | \$723 |
| HS82ABC | 97 | 27.5 | \$853 | \$920 | \$986 |

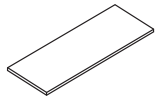

Extra Shelf for all Models

NOTES: Edge is ¼" thick. Specify: Paint

| | | | | | |
|------------|-----|-----|-------------|--------------|--------------|
| HB9 | 7 Ⓞ | 0.3 | \$98 | \$111 | \$121 |
|------------|-----|-----|-------------|--------------|--------------|

NOTES:

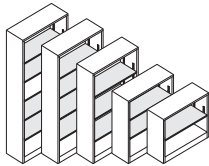

- Available in 2, 3, 4, 5, and 6 shelf models.
- Inside shelf depth is 12⅝".
- Bookcase shelves easily adjust in ½" increments (shaded shelves are adjustable).
- Optional laminate tops available.
- Baked enamel finish over rust-inhibiting phosphate pre-treatment.

HOW TO SPECIFY

| | |
|--|---|
| <p>Select Model Number</p> <p>HS30ABC</p> | <p>Select Paint Color</p> <p>See page 655</p> <p>P</p> |
|--|---|

DESCRIPTION

Laminate Top for all Models
 NOTES: Specify: Laminate

| MODEL | SHIP WEIGHT | CUBE | LIST PRICE |
|----------------|-------------|------|--------------|
| H511596 | 16 Ⓞ | 0.7 | \$293 |

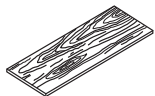

HOW TO SPECIFY

| | |
|--|--|
| <p>Select Model Number</p> <p>H511596</p> | <p>Select Laminate</p> <p>See page 655</p> <p>N</p> |
|--|--|

STORAGE

BRIGADE® Storage Cabinets

GSA SIN 33721



Icon Legend on page 19



71¾" High

DESCRIPTION

Storage Cabinets

36"W x 18½"D x 72"H
36"W x 24½"D x 72"H

NOTES: Includes 5 adjustable shelves.

| MODEL | SHIP WEIGHT | CUBE | LIST PRICE BY PAINT GRADE | | |
|---------|-------------|------|---------------------------|--------|--------|
| | | | P1 | P2 | P3 |
| HSC1872 | 131 | 36.5 | \$1140 | \$1207 | \$1273 |
| HSC2472 | 149 | 46.7 | \$1429 | \$1496 | \$1562 |

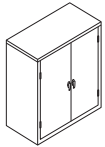

41¾" High

Storage Cabinet

36"W x 18½"D x 39½"H

NOTES: Includes 2 adjustable shelves.

| | | | | | |
|---------|----|------|-------|--------|--------|
| HSC1842 | 82 | 21.8 | \$963 | \$1008 | \$1052 |
|---------|----|------|-------|--------|--------|

Additional Shelves

36"W x 18"D
36"W x 24"D

| | | | | | |
|-------|---|-----|-------|-------|-------|
| HAS18 | 6 | 0.6 | \$136 | \$149 | \$159 |
| HAS24 | 8 | 0.7 | \$169 | \$182 | \$192 |

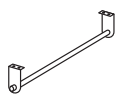

Conversion Kit

Hanging Bar and brackets to convert a Storage Cabinet into a Wardrobe Cabinet.

| | | | | | |
|-------|---|-----|-------|--|--|
| HWC72 | 5 | 0.4 | \$126 | | |
|-------|---|-----|-------|--|--|

NOTES: Necessary hardware included to screw into shelf.

❗ For use on 72"H HSC Model Storage Cabinets shown above, only.

❗ Aluminum finish only. No need to specify paint color.

SPECIFY: HWC72

NOTES:

- Product shipped fully assembled.
- All shelves are adjustable in 2" increments.
- Stretch-wrap cartoning.
- Flush top.
- Two adjustable leveling glides standard.
- Reinforced base.
- One locking handle, one fixed handle.
- Adjustable shelves.
- Doors have vertical stiffener standard.
- Positive door stops.
- Equipped with HON "One Key" interchangeable core removable locks.

❗ Keyed alike cores must be ordered separately – see page 773.

HOW TO SPECIFY

| | | |
|---|-------------------------------------|--|
| Select Model Number H S C 2 4 7 2 | Select Lock Option L Lock | Select Paint Color See page 655 P |
|---|-------------------------------------|--|



Contain® Lockers with
Electronic Locks.

STORAGE

CONTAIN®

Harder-working storage. That's what you need. So we re-examined it from the inside out and developed our new Contain storage solutions. With a variety of shapes and sizes, functions and configurations, Contain can help you expand your capabilities for storage, efficiency, and collaboration — and elevate your aesthetic too.



FEATURES

- Contain® provides the storage solutions you need, where you need them. Personal workstations, private offices, shared spaces, Contain® has you covered.
- Combine metal and laminate to create a unique and unified look for your office.
- Add a pop of color with standard HON paint or Colorway paint options.
- Punch up the personality of your storage with dual paint options, available in traditional HON colors or vibrant Colorway hues.
- Choose between a footed base to create a stand-alone furniture aesthetic, a recessed kickplate that matches both the drawer fronts, or an optional flush kickplate.
- Pair low credenzas and pedestals with seat cushions to turn any space into a collaborative hub.
- Leave the key in the past with our digital keypad or RFID lock options.
- Incorporate Contain® lockers and wardrobes into Storage Islands to create simple touchdown spaces throughout the office.

CONTAIN® ORDERING INFORMATION

STORAGE

CONTAIN® PRODUCTS CASE PAINT

| PAINTS | CODES |
|----------------------|-------|
| P1 | |
| ◆ Black | P |
| ◆ Brownstone | P7D |
| ◆ Charcoal | S |
| ◆ Designer White | PJW |
| ◆ Fossil | P28 |
| ◆ Greige | T5 |
| ◆ Light Gray | Q |
| ◆ Loft | LOFT |
| ◆ Muslin | T3 |
| ◆ Putty | L |
| ◆ Shadow* | SHDW |
| ◆ Titanium | P8T |
| P2 | |
| ◆ Champagne Metallic | T4 |
| ◆ Platinum Metallic | T1 |
| ◆ Silver | PR6 |
| ◆ Solar Black | P8X |
| P3 | |
| ◆ Atom | P8S |
| ◆ Bullseye | PJF |
| ◆ Ember | P8P |
| ◆ Ion | P8N |
| ◆ Iris | P8J |
| ◆ Krypton | P8F |
| ◆ Regatta | P8M |

CONTAIN® PRODUCTS

| L1 LAMINATES | CODES |
|---------------------|--------------|
| Woodgrain | |
| ◆ Bourbon Cherry | H |
| ◆ Cognac | COGN |
| ◆ Florence Walnut | LFW1 |
| ◆ Harvest | C |
| ◆ Kingswood Walnut | LK11 |
| ◆ Mahogany | N |
| ◆ Mocha | MOCH |
| ◆ Natural Maple | D |
| ◆ Pinnacle | PINC |
| ◆ Shaker Cherry | F |
| ◆ Sterling Ash | LSA1 |
| L2 LAMINATES | CODES |
| Woodgrain | |
| ◆ Lowell Ash | LLA1 |
| ◆ Natural Recon | LNRT |
| ◆ Phantom Ecru | LPE1 |
| ◆ Portico Teak | LPT1 |
| ◆ Skyline Walnut | LSW1 |

OPTIONAL LAMINATE TOPS FOR LATERAL FILES AND CONTAIN® CREDENZAS





| L1 LAMINATES | CODES |
|---------------------|--------------|
| Woodgrain | |
| ◆ Bourbon Cherry | H |
| ◆ Cognac | COGN |
| ◆ Florence Walnut | LFW1 |
| ◆ Harvest | C |
| ◆ Kingswood Walnut | LK11 |
| ◆ Mahogany | N |
| ◆ Mocha | MOCH |
| ◆ Natural Maple | D |
| ◆ Pinnacle | PINC |
| ◆ Shaker Cherry | F |
| ◆ Sterling Ash | LSA1 |
| Solid | |
| ◆ Charcoal | S |
| ◆ Designer White | LDW1 |
| ◆ Loft | LOFT |
| Patterned | |
| ◆ Handspun Chestnut | LAHC |
| ◆ Handspun Dove | LAHD |
| ◆ Handspun Pearl | LAHP |
| ◆ Handspun Slate | LAHS |
| ◆ Sheer Mesh* | A5 |
| ◆ Silver Mesh* | B9 |
| ◆ Steel Mesh* | A9 |
| ◆ Canyon Zephyr* | K9 |
| ◆ Desert Zephyr* | K8 |
| ◆ Shadow Zephyr* | K1 |
| ◆ Gray* | G2 |
| ◆ White* | G1 |
| L2 LAMINATES | CODES |
| Woodgrain | |
| ◆ Lowell Ash | LLA1 |
| ◆ Natural Recon | LNRT |
| ◆ Phantom Ecru | LPE1 |
| ◆ Portico Teak | LPT1 |
| ◆ Skyline Walnut | LSW1 |

CONTAIN® PRODUCTS FRONT PAINT

| PAINTS | CODES |
|----------------------|-------|
| P1 | |
| ◆ Black | P |
| ◆ Brownstone | P7D |
| ◆ Charcoal | S |
| ◆ Designer White | PJW |
| ◆ Fossil | P28 |
| ◆ Greige | T5 |
| ◆ Light Gray | Q |
| ◆ Loft | LOFT |
| ◆ Muslin | T3 |
| ◆ Putty | L |
| ◆ Shadow* | SHDW |
| ◆ Titanium | P8T |
| P2 | |
| ◆ Champagne Metallic | T4 |
| ◆ Platinum Metallic | T1 |
| ◆ Silver | PR6 |
| ◆ Solar Black | P8X |
| P3 | |
| ◆ Atom | P8S |
| ◆ Bullseye | PJF |
| ◆ Ember | P8P |
| ◆ Ion | P8N |
| ◆ Iris | P8J |
| ◆ Krypton | P8F |
| ◆ Regatta | P8M |

NOTES: L2 laminate front upcharge is \$35 per list unit.

PULL OPTIONS FOR CONTAIN® AND FLAGSHIP® STORAGE

| "A" | "N" | "R" | "S" |
|---|---|---|---|
|  |  |  |  |
| Satin Chrome Arch Pull | Full Face Integral Drawer Pull | Full Radius Drawer Pull | Square Drawer Pull |

NOTES: Arch Pulls available in Satin Chrome only. Linear Pull coming soon.

* Laminate colors will have the following pre-set edgeband colors:

| Laminate | Edge |
|-------------|----------|
| Sheer Mesh | Muslin |
| Silver Mesh | Loft |
| Steel Mesh | Charcoal |
| Gray | Charcoal |
| White | Charcoal |

Edgeband matches top except as noted.

For Champagne Metallic Paint, Muslin is the suggested edgeband color. When Champagne Metallic Paint is selected, pulls are standard in Muslin.

◆◆◆ For lead time information see page 19.

* De-emphasized

METAL CRENZAS WITH PANEL FRAMES

Guidelines for using Contain[®] Credenzas in place of standard panel systems configurations

Side-mounted Credenzas

Use 1 storage-to-panel bracket set.

The minimum credenza size is 22"H x 36"W x 18"D.

With a mid-run floor support, the maximum panel run is 144".

Without a mid-run panel attached floor support, the maximum panel run is 96".

Overheads and shelves cannot be used with 22"H side mounted credenzas.

Worksurfaces (if specified) must be mounted on the same side of the parent run as the credenzas.

Panel frame maximum height is 68".

Counterweight is required, if using unit with drawers.

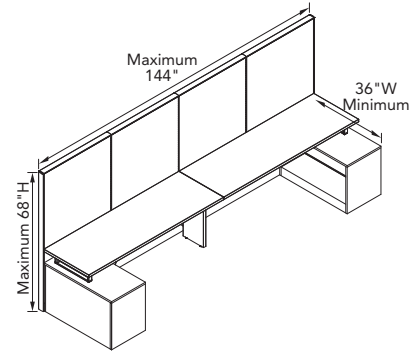

Back-mounted Credenzas — Modular

Use 2 storage-to-panel bracket sets per Credenza — 2 LH and 2 RH.

The minimum credenza size is 22"H x 36"W x 18"D.

The maximum panel run between back-mounted credenzas is 60".

Overheads and shelves cannot be used with 22"H back mounted credenzas.

Worksurfaces (if specified) must be mounted on the same side of the parent run as the credenzas.

Panel frame maximum height is 68".

Counterweights are required in a single side run configuration as shown.

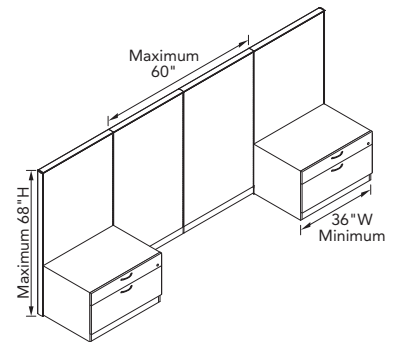

Side-mounted Credenzas — with Return Panel

Use 1 storage-to-panel bracket on Credenza LH or RH of set.

The minimum credenza size is 22"H x 36"W x 18"D.

The minimum size for panel return is 35"H x 36"W.

With a mid-run panel attached floor support, the maximum panel run is 144".

Without a mid-run floor support, the maximum panel run is 96".

Overheads and shelves cannot be used with 22"H side mounted credenzas.

Worksurfaces (if specified) must be mounted on the same side of the parent run as the credenzas.

Panel frame maximum height is 68".

Counterweight is required, if using unit with drawers.

Mid-run floor support options include:

Back-to-Back Credenzas

Panel Attached O-legs

Panel Attached Support Legs

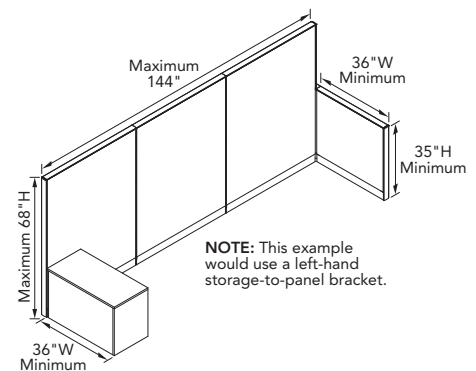

COUNTERWEIGHT REQUIREMENTS FOR CONTAIN[®] CRENZAS

| Series | 24"W Box/File Unit | 30"W Box/File Unit | 36"W Box/File Unit | 42"W Combo Unit | 48"W Combo Unit | 60"W Combo Unit | 72"W Combo Unit |
|--------|--|---|---|--|--|--|--|
| 18"D | HSCACW35 35 lbs. (two 12½ lb. and two 5 lb. counterweights) | HSCACW50 50 lbs. (four 12½ lb. counterweights) | HSCACW50 50 lbs. (four 12½ lb. counterweights) | HSCACW25 25 lbs. (two 12½ lb. counterweights) | HSCACW25 25 lbs. (two 12½ lb. counterweights) | HSCACW35 35 lbs. (two 12½ lb. and two 5 lb. counterweights) | HSCACW35 35 lbs. (two 12½ lb. and two 5 lb. counterweights) |

Counterweight is not required if credenzas are used within a standard Systems set up and attached with the Credenza Storage-to-Panel Brackets.

CONTAIN[®] Metal Credenzas

GSA SIN 33721



Icon Legend on page 19

STORAGE

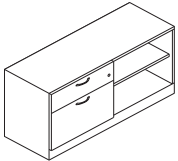
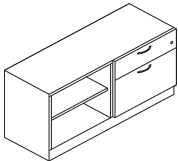
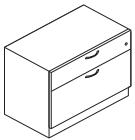
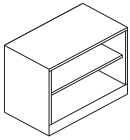
| | DESCRIPTION | MODEL | SHIP WEIGHT | CUBE | LIST PRICE BY PAINT GRADE | | |
|---|---|------------------------|-------------|------|---------------------------|---------------|---------------|
| | | | | | P1 | P2 | P3 |
|  | Low Credenza, Box/Lateral Left, Open Shelf Right | | | | | | |
| | 72"W x 18"D x 22"H | HSCP227218RBFOM | 150 | 20.7 | \$2154 | \$2221 | \$2289 |
| | 60"W x 18"D x 22"H | HSCP226018RBFOM | 130 | 17.3 | \$1943 | \$2010 | \$2078 |
| | 48"W x 18"D x 22"H | HSCP224818RBFOM | 111 | 14.0 | \$1792 | \$1859 | \$1927 |
|  | Low Credenza, Box/Lateral Right, Open Shelf Left | | | | | | |
| | 72"W x 18"D x 22"H | HSCP227218LBFOM | 150 | 20.7 | \$2154 | \$2221 | \$2289 |
| | 60"W x 18"D x 22"H | HSCP226018LBFOM | 130 | 17.3 | \$1943 | \$2010 | \$2078 |
| | 48"W x 18"D x 22"H | HSCP224818LBFOM | 111 | 14.0 | \$1792 | \$1859 | \$1927 |
|  | Low Credenza, Box/Lateral | | | | | | |
| | 36"W x 18"D x 22"H | HSCP223618BFM | 87 | 10.6 | \$1318 | \$1351 | \$1386 |
| | 30"W x 18"D x 22"H | HSCP223018BFM | 76 | 9.0 | \$1263 | \$1296 | \$1331 |
|  | Open Shelf | | | | | | |
| | 36"W x 18"D x 22"H | HSCP223618O | 66 | 10.6 | \$939 | \$972 | \$1007 |
| | 30"W x 18"D x 22"H | HSCP223018O | 60 | 9.0 | \$865 | \$898 | \$933 |

NOTES:

- Metal chassis and drawer fronts.
- Lateral and wide box drawers operate on ball-bearing suspension with full extension.
- Steel ball-bearing drawer suspensions.
- Ships complete with standard kickplate.
- Field installable counterweight sold separately.
- File drawers accept hanging folders in letter or legal size.
- Steel frame provides durability.
- Use with laminate tops and credenza seat cushions. Order separately — see pages 675-676.

⚠ Locking units equipped with HON "One Key" interchangeable core removable locks. Keyed alike core model HF23S, in Satin, must be ordered separately. See page 675.

HOW TO SPECIFY

| | | | | | | |
|---|--|---|---|---|--|--|
| Select Model Number H S C P 2 2 3 6 1 8 O . | Select Base BK Flush Plinth BX Recessed Plinth B K . | Select Case Paint See page 666 P J W . | Select Shelf Paint See page 666 P J W | | | |
| Select Model Number H S C P 2 2 7 2 1 8 R B F O M . | Select Base BK Flush Plinth BX Recessed Plinth B K . | Select Pull A Arch PRO Silver R Radius N Integral S Square PR6 Silver A P R O . | Select Case Paint See page 666 P J W . | Select Front Paint NA Matches Case N A . | Select Shelf Paint See page 666 Not specified for models HSCP223018BFM and HSCP223618BFM P J W . | Select Lock L Standard Lock X Omit Lock (- \$20) Not specified for models HSCP223618O and HSCP223018O L |



Icon Legend on page 19

CONTAIN® Footed Metal Credenzas

| | DESCRIPTION | MODEL | SHIP WEIGHT | CUBE | LIST PRICE BY PAINT GRADE | | |
|--|--|------------------------|-------------|------|---------------------------|---------------|---------------|
| | | | | | P1 | P2 | P3 |
| | Footed Low Credenza, Box/Lateral Left, Open Shelf Right | | | | | | |
| | 72"W x 18"D x 22"H | HSCF227218RBFOM | 150 | 17.7 | \$2327 | \$2394 | \$2462 |
| | 60"W x 18"D x 22"H | HSCF226018RBFOM | 130 | 14.9 | \$2118 | \$2185 | \$2253 |
| | 48"W x 18"D x 22"H | HSCF224818RBFOM | 111 | 12.0 | \$1932 | \$1999 | \$2067 |
| | Footed Low Credenza, Box/Lateral Right, Open Shelf Left | | | | | | |
| | 72"W x 18"D x 22"H | HSCF227218LBFOM | 150 | 17.7 | \$2327 | \$2394 | \$2462 |
| | 60"W x 18"D x 22"H | HSCF226018LBFOM | 130 | 14.9 | \$2118 | \$2185 | \$2253 |
| | 48"W x 18"D x 22"H | HSCF224818LBFOM | 111 | 12.0 | \$1932 | \$1999 | \$2067 |
| | Footed Low Credenza, Box/Lateral | | | | | | |
| | 36"W x 18"D x 22"H | HSCF223618BFM | 87 | 9.1 | \$1457 | \$1490 | \$1525 |
| | 30"W x 18"D x 22"H | HSCF223018BFM | 76 | 7.7 | \$1401 | \$1434 | \$1469 |
| | Footed Open Shelf | | | | | | |
| | 36"W x 18"D x 22"H | HSCF223618O | 66 | 9.1 | \$1079 | \$1112 | \$1147 |
| | 30"W x 18"D x 22"H | HSCF223018O | 60 | 7.7 | \$1004 | \$1037 | \$1072 |

STORAGE

NOTES:

- Lateral and wide box drawers operate on ball-bearing suspension with full extension.
 - Steel ball-bearing drawer suspensions.
 - Ships complete with standard footed base.
 - Field installable counterweight sold separately.
 - File drawers accept hanging folders in letter or legal size.
 - Steel frame provides durability.
 - Feet are shipped with the credenza unit and are easily assembled.
 - Use with laminate tops and credenza seat cushions. Order separately — see pages 675-676.
- ⓘ Locking units equipped with HON "One Key" interchangeable core removable locks. Keyed alike core model HF23S, in Satin, must be ordered separately. See page 675.

HOW TO SPECIFY

| | | | |
|--|--|--|---|
| <p>Select Model Number</p> <p>HSCF223618O</p> | <p>Select Foot</p> <p>SF Contain Foot T1 Platinum Metallic PR6 Silver</p> <p>SFT1</p> | <p>Select Case Paint</p> <p>See page 666</p> <p>PJW</p> | <p>Select Shelf Paint</p> <p>See page 666</p> <p>PJW</p> |
|--|--|--|---|

| | | | | | | |
|--|--|--|--|---|--|---|
| <p>Select Model Number</p> <p>HSCF227218RBFOM</p> | <p>Select Foot</p> <p>SF Contain Foot T1 Platinum Metallic PR6 Silver</p> <p>SFT1</p> | <p>Select Pull</p> <p>A Arch PRO Silver R Radius N Integral S Square PR6 Silver</p> <p>APRO</p> | <p>Select Case Paint</p> <p>See page 666</p> <p>PJW</p> | <p>Select Front Paint</p> <p>NA Matches Case</p> <p>NA</p> | <p>Select Shelf Paint</p> <p>See page 666 Not specified for models HSCF223618BFM and HSCF223018BFM</p> <p>PJW</p> | <p>Select Lock</p> <p>L Standard Lock X Omit Lock (- \$20) Not specified for models HSCF223618O and HSCF223018O</p> <p>L</p> |
|--|--|--|--|---|--|---|

CONTAIN[®] Metal Credenzas with Laminate Fronts

GSA SIN 33721

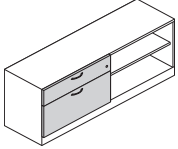
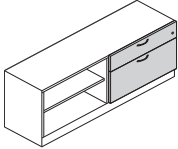
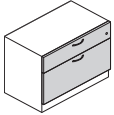

Icon Legend on page 19

| | DESCRIPTION | MODEL | SHIP WEIGHT | CUBE | LIST PRICE BY PAINT GRADE | | |
|--|---|------------------------|-------------|------|---------------------------|---------------|---------------|
| | | | | | P1 | P2 | P3 |
|  | Metal Low Credenza, Laminate Front, Box/Lateral Left, Open Shelf Right | | | | | | |
| | 72"W x 18"D x 22"H | HSCP227218RBFOL | 152 | 20.7 | \$2389 | \$2456 | \$2524 |
| | 60"W x 18"D x 22"H | HSCP226018RBFOL | 132 | 17.3 | \$2179 | \$2246 | \$2314 |
| | 48"W x 18"D x 22"H | HSCP224818RBFOL | 113 | 14.0 | \$2027 | \$2094 | \$2162 |
|  | Metal Low Credenza, Laminate Front, Box/Lateral Right, Open Shelf Left | | | | | | |
| | 72"W x 18"D x 22"H | HSCP227218LBFOL | 152 | 20.7 | \$2389 | \$2456 | \$2524 |
| | 60"W x 18"D x 22"H | HSCP226018LBFOL | 132 | 17.3 | \$2179 | \$2246 | \$2314 |
| | 48"W x 18"D x 22"H | HSCP224818LBFOL | 113 | 14.0 | \$2027 | \$2094 | \$2162 |
|  | Metal Low Credenza, Laminate Front Box/Lateral | | | | | | |
| | 36"W x 18"D x 22"H | HSCP223618BFL | 89 | 10.6 | \$1553 | \$1586 | \$1621 |
| | 30"W x 18"D x 22"H | HSCP223018BFL | 76 | 9.0 | \$1497 | \$1530 | \$1565 |

STORAGE

NOTES:

- Lateral and wide box drawers operate on ball-bearing suspension with full extension.
- Steel ball-bearing drawer suspensions.
- Ships complete with standard kickplate.
- Field installable counterweight sold separately.
- File drawers accept hanging folders in letter or legal size.
- Steel frame provides durability.
- Use with laminate tops and credenza seat cushions. Order separately — see pages 675-676.

ⓘ Locking units equipped with HON "One Key" interchangeable core removable locks. Keyed alike core model HF23S, in Satin, must be ordered separately. See page 675.

HOW TO SPECIFY

| Select Model Number | Select Base | Select Pull | Select Case Paint | Select Laminate | Select Shelf Paint | Select Lock |
|---------------------------------|---------------------------|--|-------------------|-----------------|--|---|
| | BX Recessed Plinth | A Arch PRO Silver S Square PR6 Silver | See page 666 | See page 666 | See page 666 Not specified for models HSCP223618BFL and HSCP223018BFL | L Standard Lock X Omit Lock (- \$20) |
| H S C P 2 2 7 2 1 8 R B F O L . | B X . | A P R O . | P J W . | L S A 1 . | P J W . | L |



Icon Legend on page 19

Footed Metal Credenzas with Laminate Fronts

| | DESCRIPTION | MODEL | SHIP WEIGHT | CUBE | LIST PRICE BY PAINT GRADE | | |
|--|--|------------------------|-------------|------|---------------------------|---------------|---------------|
| | | | | | P1 | P2 | P3 |
| | Footed Low Credenza, Laminate Front, Box/Lateral Left, Open Shelf Right | | | | | | |
| | 72"W x 18"D x 22"H | HSCF227218RBFOL | 152 | 17.7 | \$2564 | \$2631 | \$2699 |
| | 60"W x 18"D x 22"H | HSCF226018RBFOL | 132 | 14.9 | \$2352 | \$2419 | \$2487 |
| | 48"W x 18"D x 22"H | HSCF224818RBFOL | 113 | 12.0 | \$2167 | \$2234 | \$2302 |
| | Footed Low Credenza, Laminate Front, Box/Lateral Right, Open Shelf Left | | | | | | |
| | 72"W x 18"D x 22"H | HSCF227218LBFOL | 152 | 17.7 | \$2564 | \$2631 | \$2699 |
| | 60"W x 18"D x 22"H | HSCF226018LBFOL | 132 | 14.9 | \$2352 | \$2419 | \$2487 |
| | 48"W x 18"D x 22"H | HSCF224818LBFOL | 113 | 12.0 | \$2167 | \$2234 | \$2302 |
| | Footed Low Credenza, Laminate Front Box/Lateral | | | | | | |
| | 36"W x 18"D x 22"H | HSCF223618BFL | 89 | 9.1 | \$1692 | \$1725 | \$1760 |
| | 30"W x 18"D x 22"H | HSCF223018BFL | 78 | 7.7 | \$1638 | \$1671 | \$1706 |

NOTES:

- Lateral and wide box drawers operate on ball-bearing suspension with full extension.
- Steel ball-bearing drawer suspensions.
- Ships complete with standard footed base.
- Field installable counterweight sold separately.
- File drawers accept hanging folders in letter or legal size.
- Steel frame provides durability.
- Feet are shipped with the credenza unit and are easily assembled.
- Use with laminate tops and credenza seat cushions. Order separately — see pages 675-676.

! Locking units equipped with HON "One Key" interchangeable core removable locks. Keyed alike core model HF23S, in Satin, must be ordered separately. See page 675.

STORAGE

HOW TO SPECIFY



| | | | | | | |
|----------------------------|---|--|--------------------------|------------------------|--|---|
| Select Model Number | Select Foot | Select Pull | Select Case Paint | Select Laminate | Select Shelf Paint | Select Lock |
| | SF Contain Foot T1 Platinum Metallic PR6 Silver | A Arch PRO Silver S Square PR6 Silver | See page 666 | See page 666 | See page 666 Not specified for models HSCF223618BFL and HSCF223018BFL | L Standard Lock X Omit Lock (- \$20) |
| HSCF227218RBFOL | SFT1 | APRO | PJW | LSA1 | PJW | L |

CONTAIN[®] Personal Files

OPEN MARKET

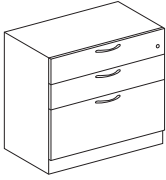

Icon Legend on page 19

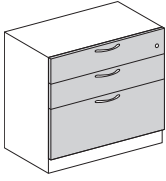
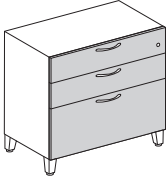
| | DESCRIPTION | MODEL | SHIP WEIGHT | CUBE | LIST PRICE BY PAINT GRADE | | |
|---|---|------------------------|-------------|------|---------------------------|---------------|---------------|
| | | | | | P1 | P2 | P3 |
|  | Box/Box/File 30"W x 18"D x 28"H | HSFCP283018BBFM | 90 | 11.3 | \$1459 | \$1492 | \$1527 |
|  | Footed, Box/Box/File 30"W x 18"D x 28"H | HSFCF283018BBFM | 90 | 11.3 | \$1604 | \$1637 | \$1672 |
|  | Box/Box/File, Laminate Front Base 30"W x 18"D x 28"H | HSFCP283018BBFL | 90 | 11.3 | \$1677 | \$1710 | \$1745 |
|  | Footed, Box/Box/File, Laminate Front 30"W x 18"D x 28"H | HSFCF283018BBFL | 90 | 11.3 | \$1824 | \$1857 | \$1892 |

STORAGE

NOTES:

- Lateral and wide box drawers operate on ball-bearing suspension with full extension.
- Steel ball-bearing drawer suspensions.
- Field installable counterweight sold separately.
- File drawers accept hanging folders in letter or legal size.
- Steel frame provides durability.

! Locking units equipped with HON "One Key" interchangeable core removable locks.

HOW TO SPECIFY

| | | | | | |
|---|---|--|---|--|--|
| Select Model Number HSFCP283018BBFM | Select Base BK Flush Plinth BX Recessed Plinth BK | Select Pull A Arch PRO Silver R Radius N Integral S Square PR6 Silver APRO | Select Case Paint See page 666 PJW | Select Front Paint NA Matches Case NA | Select Lock L Standard Lock X Omit Lock (- \$20) L |
|---|---|--|---|--|--|

| | | | | | |
|---|---|--|---|--|--|
| Select Model Number HSFCF283018BBFL | Select Foot SF Contain Foot T1 Platinum Metallic PR6 Silver SFT1 | Select Pull A Arch PRO Silver S Square PR6 Silver APRO | Select Case Paint See page 666 PJW | Select Laminate See page 666 LSA1 | Select Lock L Standard Lock X Omit Lock (- \$20) L |
|---|---|--|---|--|--|



Icon Legend on page 19

CONTAIN® Lateral Files

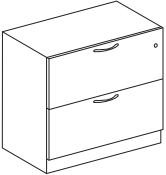
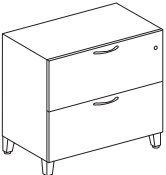
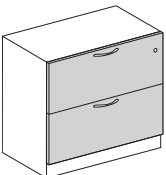
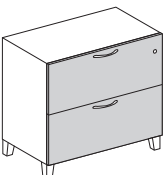
| | DESCRIPTION | MODEL | SHIP WEIGHT | CUBE | LIST PRICE BY PAINT GRADE | | |
|--|--|----------------------|-------------|------|---------------------------|---------------|---------------|
| | | | | | P1 | P2 | P3 |
|  | 2 Drawer Lateral 30"W x 18"D x 28"H 36"W x 18"D x 28"H | HSLP283018FFM | 90 | 11.3 | \$1136 | \$1169 | \$1204 |
| | | HSLP283618FFM | 101 | 13.4 | \$1335 | \$1368 | \$1403 |
|  | Footed 2 Drawer Lateral 30"W x 18"D x 28"H 36"W x 18"D x 28"H | HSLF283018FFM | 90 | 11.3 | \$1329 | \$1362 | \$1397 |
| | | HSLF283618FFM | 101 | 13.4 | \$1468 | \$1501 | \$1536 |
|  | 2 Drawer Lateral, Laminate Front 30"W x 18"D x 28"H 36"W x 18"D x 28"H | HSLP283018FFL | 98 | 11.3 | \$1405 | \$1438 | \$1473 |
| | | HSLP283618FFL | 109 | 13.4 | \$1533 | \$1566 | \$1601 |
|  | Footed 2 Drawer Lateral, Laminate Front 30"W x 18"D x 28"H 36"W x 18"D x 28"H | HSLF283018FFL | 98 | 11.3 | \$1533 | \$1566 | \$1601 |
| | | HSLF283618FFL | 109 | 13.4 | \$1687 | \$1720 | \$1755 |

STORAGE

NOTES:

- Lateral and wide box drawers operate on ball-bearing suspension with full extension.
- Steel ball-bearing drawer suspensions.
- Field installable counterweight sold separately.
- File drawers accept hanging folders in letter or legal size.
- Steel frame provides durability.
- Contain® Laterals can be used with Storage Islands.

! Locking units equipped with HON "One Key" interchangeable core removable locks.

HOW TO SPECIFY

| | | | | | |
|-----------------------------|---|--|--|--|---|
| Select Model Number | Select Base BK Flush Plinth BX Recessed Plinth | Select Pull A Arch PRO Silver R Radius N Integral S Square PR6 Silver | Select Case Paint See page 666 | Select Front Paint NA Matches Case | Select Lock L Standard Lock X Omit Lock (- \$20) |
| H S L P 2 8 3 0 1 8 F F M . | B K . | A P R O . | P J W . | N A . | L . |

| | | | | | |
|-----------------------------|---|--|--|--|---|
| Select Model Number | Select Foot SF Contain Foot T1 Platinum Metallic PR6 Silver | Select Pull A Arch PRO Silver S Square PR6 Silver | Select Case Paint See page 666 | Select Laminate See page 666 | Select Lock L Standard Lock X Omit Lock (- \$20) |
| H S L F 2 8 3 0 1 8 F F L . | S F T 1 . | A P R O . | P J W . | L S A 1 . | L . |

CONTAIN[®] Lateral File Accessories

GSA SIN AS NOTED



Icon Legend on page 19

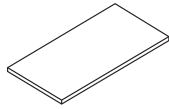

SIN 33721

DESCRIPTION

Credenza Laminate Top — Square Edge

72"W x 18"D x 1/8" Thick
60"W x 18"D x 1/8" Thick
48"W x 18"D x 1/8" Thick
36"W x 18"D x 1/8" Thick
30"W x 18"D x 1/8" Thick

| MODEL | SHIP WEIGHT | CUBE | LIST PRICE BY LAMINATE GRADE | |
|---------|-------------|------|------------------------------|-------|
| | | | L1 | L2 |
| H919472 | 48 | 3.5 | \$915 | \$930 |
| H919460 | 32 | 3.0 | \$780 | \$795 |
| H919448 | 31 | 2.6 | \$684 | \$694 |
| H919436 | 25 | 1.8 | \$565 | \$575 |
| H919430 | 20 | 1.6 | \$451 | \$461 |

NOTES: Square-edge laminate tops provide a finished look to credenzas. See Storage Islands on page 729 for full laminate solution.

Specify laminate only.

SPECIFYING EXAMPLE: H919448.C

DESCRIPTION

Front-to-Back Hangrail Kits

15"D for 24"D Credenza or 18"D Lateral

No specification needed.

| MODEL | SHIP WEIGHT | CUBE | LIST PRICE |
|----------|-------------|------|------------|
| HSCAHR15 | 0.1 | 0.2 | \$22 |



OPEN MARKET

Counterweight for Contain 28"H Laterals

50 lbs for 30" Lateral
57½ lbs for 36" Lateral

| | | | |
|----------|-----|------|-------|
| HSLACW50 | 2.0 | 55.0 | \$229 |
| HSLACW57 | 2.0 | 63.0 | \$240 |

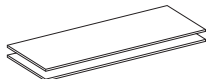

OPEN MARKET

Field Installable Drawer/Door Handle Kits

Field Installable Pull, 2 Pack
Field Installable Pull, 3 Pack

| | | | |
|--------|-----|-----|------|
| HPULL2 | 0.4 | 0.3 | \$60 |
| HPULL3 | 0.5 | 0.3 | \$68 |

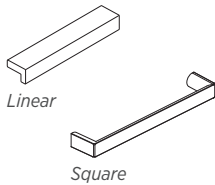

NOTES: Square and Linear pull packs provide the option to coordinate with Fuse™ Storage. Pull packs are field installable on all Contain® Storage Products, excluding electronic locking units.

STORAGE

HOW TO SPECIFY

| | |
|--|--|
| Select Model Number <input type="text" value="H919472."/> | Select Laminate Color See page 666 <input type="text" value="C"/> |
| Select Model Number <input type="text" value="HSLACW50."/> | Select Paint Color See page 666 <input type="text" value="S"/> |
| Select Model Number <input type="text" value="HPULL2."/> | Select Pull Style and Color LP Linear Black LPR6 Linear Silver SPR6 Square Silver <input type="text" value="LPR6"/> |



CONTAIN® Metal Credenzas Accessories

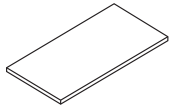

| DESCRIPTION | MODEL | SHIP WEIGHT | CUBE | LIST PRICE BY LAMINATE GRADE | |
|--|----------------|---------------|------|------------------------------|--------------|
| | | | | L1 | L2 |
| Credenza Laminate Top — Square Edge | | | | | |
| 72"W x 18"D x 1/8" Thick | H919472 | 48.0 | 3.5 | \$915 | \$930 |
| 60"W x 18"D x 1/8" Thick | H919460 | 32.0 | 3.0 | \$780 | \$795 |
| 48"W x 18"D x 1/8" Thick | H919448 | 31.0 | 2.6 | \$684 | \$694 |
| 36"W x 18"D x 1/8" Thick | H919436 | 25.0 Ⓔ | 1.8 | \$565 | \$575 |
| 30"W x 18"D x 1/8" Thick | H919430 | 20.0 Ⓔ | 1.6 | \$451 | \$461 |

NOTES: Square-edge laminate tops provide a finished look to credenzas.

⚠ Specify laminate only.

SPECIFYING EXAMPLE: H919448.C

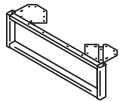

| DESCRIPTION | MODEL | SHIP WEIGHT | CUBE | LIST PRICE BY PAINT GRADE | | |
|--------------------------|-------------------|-------------|------|---------------------------|--------------|--------------|
| | | | | P1 | P2 | P3 |
| Worksurface O-Leg | | | | | | |
| 30"W x 6 1/2"H | HSCAWS6530 | 7.0 | 1.0 | \$254 | \$264 | \$269 |
| 24"W x 6 1/2"H | HSCAWS6524 | 6.0 | 1.0 | \$212 | \$222 | \$227 |
| 20"W x 6 1/2"H | HSCAWS6520 | 5.0 | 1.0 | \$184 | \$194 | \$199 |

NOTES: Worksurfaces with O-Legs may be placed upon Low Credenzas to create layering.

⚠ Specify paint only.

SPECIFYING EXAMPLE: HSCAWS6530.S

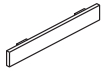

| | | | | | | |
|----------------------------|------------------|-----|-----|--------------|--------------|--------------|
| Credenza Kickplates | | | | | | |
| For 36" Box/File Model | HSCCK36BF | 3.0 | 0.5 | \$146 | \$156 | \$171 |
| For 30" Box/File Model | HSCCK30BF | 2.0 | 0.4 | \$135 | \$145 | \$160 |
| For 24" Box/File Model | HSCCK24BF | 2.0 | 0.4 | \$120 | \$130 | \$145 |
| For 36" Open File Model | HSCCK36O | 3.0 | 0.5 | \$146 | \$156 | \$171 |
| For 30" Open File Model | HSCCK30O | 2.0 | 0.4 | \$135 | \$145 | \$160 |

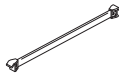

| | | | | | | |
|-------------------------------|-----------------|--------------|-----|-------------|------------|------------|
| Credenza Hangrail Kits | | | | | | |
| 12" for front-to-back filing | HSCAHR12 | 1.0 Ⓔ | 0.4 | \$20 | N/A | N/A |

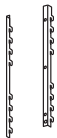

| | | | | | | |
|--|---------------|--------------|-----|--------------|--------------|--------------|
| Credenza Storage-to-Panel Bracket | HSCAPB | 0.2 Ⓔ | 0.4 | \$220 | \$232 | \$240 |
|--|---------------|--------------|-----|--------------|--------------|--------------|

Credenza Counterweight Kit

| | | | | | |
|-----------------|---------------|-----|--------------|------------|------------|
| HSCACW50 | 55.0 Ⓔ | 2.0 | \$244 | N/A | N/A |
| HSCACW35 | 40.0 Ⓔ | 2.0 | \$221 | N/A | N/A |
| HSCACW25 | 30.0 Ⓔ | 2.0 | \$197 | N/A | N/A |

NOTES: Field installable counterweight sold separately.

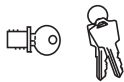

| | | | | | | |
|--------------------------------------|--------------|--------------|-----|-------------|------------|------------|
| Removable Lock Core Kit—Satin | HF23S | 0.2 Ⓔ | 0.1 | \$47 | N/A | N/A |
|--------------------------------------|--------------|--------------|-----|-------------|------------|------------|

- Use when specifying omit lock application.
- Specify quantity of each key number from 101E-225E.
- Includes: 1-core, 2-keys, 1-core removal tool and instructions.
- Removable lock core kits with specific key number must be ordered to facilitate keying alike in the field.
- For specific models, look for the Omit Lock Core icon throughout this publication.

NOTES: If key number isn't specified, number will be at random. Core matches manufactured lock on Contain® product but can be used with Contain® metal casegoods and laminate product.

HOW TO SPECIFY

| | |
|--|--|
| <p>Select Model Number</p> <p>H 9 1 9 4 4 8 .</p> | <p>Select Laminate Color</p> <p>See page 666</p> <p>C</p> |
| <p>Select Model Number</p> <p>H S C A W S 6 5 3 0 .</p> | <p>Select Paint Color</p> <p>See page 666</p> <p>S</p> |

STORAGE

CONTAIN[®] Metal Credenzas Accessories

GSA SIN 33721



Icon Legend on page 19

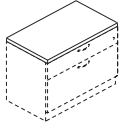

| DESCRIPTION | MODEL | SHIP WEIGHT | CUBE | SHIP | | | | | | | | | | | |
|---|-------------------|-------------|------|-------|-------|-------|-------|-------|-------|-------|-------|-------|-------|-------|-------|
| | | | | 1 | 2 | 3 | 4 | 5 | 6 | 7 | 8 | 9 | 10 | 11 | 12 |
| Credenza Cushion 36"W x 18"D for 36", 60", and 72" Credenzas | HSCAUC1836 | 16.3 | 1.6 | \$313 | \$351 | \$389 | \$428 | \$477 | \$527 | \$577 | \$626 | \$676 | \$725 | \$775 | \$825 |
| 30"W x 18"D for 30", 48", and 60" Credenzas | HSCAUC1830 | 16.3 | 1.6 | \$292 | \$330 | \$368 | \$407 | \$456 | \$506 | \$556 | \$605 | \$655 | \$704 | \$754 | \$804 |
| 24"W x 18"D for 48" Credenzas | HSCAUC1824 | 16.3 | 1.9 | \$273 | \$311 | \$349 | \$388 | \$437 | \$487 | \$537 | \$586 | \$636 | \$685 | \$735 | \$785 |

NOTES: See pages 22-24 for available fabrics.
SPECIFYING EXAMPLE: HSCAUC1836.APN23

NOTES:

- For matching Pedestal Seats, see page 701.
- Credenza Cushions are available in 24", 30" and 36" size options.
- Choose from multiple upholstery options, see pages 22-24.

STORAGE

HOW TO SPECIFY

Select Model Number

Select Fabric

See pages 22-24

H S C A U C 1 8 3 6 .

C U 1 0

| | DESCRIPTION | MODEL | SHIP WEIGHT | CUBE | LIST PRICE |
|---|--------------------------------------|-----------------|-------------|------|--------------|
| | | | | | P1 |
| | Metal Box Divider 10 pack | HSCABD10 | 7 | 0.7 | \$189 |
| | 2 pack | HSCABD02 | 2 | 0.7 | \$48 |
| ! Metal dividers available in Black only. No need to specify. | | | | | |
| | Metal File Divider 10 pack | HSCAFD10 | 12 | 0.7 | \$224 |
| | 2 pack | HSCAFD02 | 3 | 0.7 | \$60 |
| ! Metal dividers available in Black only. No need to specify. | | | | | |

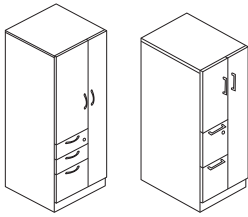

Metal Personal Towers with Plinth Base

65", 50", 42"H
24", 18"W
24"D

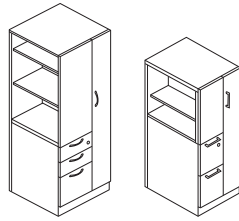

Metal Side-Access Personal Towers with Plinth Base

65", 50", 42"H
24", 18"W
24"D

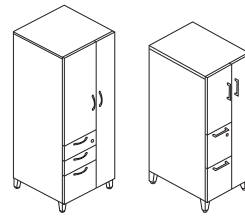

Metal Personal Towers with Footed Base

65", 50", 42"H
24", 18"W
24"D

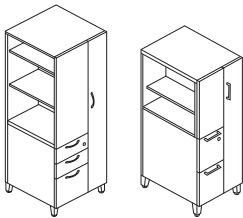

Metal Personal Towers with Footed Base

65", 50", 42"H
24", 18"W
24"D

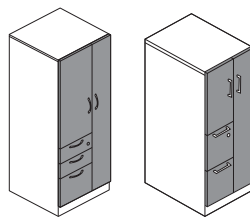

**Metal Personal Towers with Laminate Fronts,
Plinth Base**

65", 50", 42"H
24", 18"W
24"D

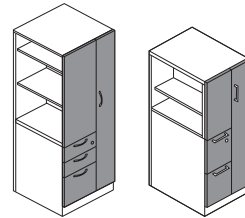

**Metal Side-Access Personal Towers with
Laminate Fronts, Plinth Base**

65", 50", 42"H
24", 18"W
24"D

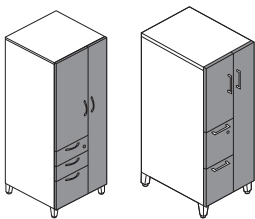

**Metal Personal Towers with Laminate
Fronts, Footed Base**

65", 50", 42"H
24", 18"W
24"D

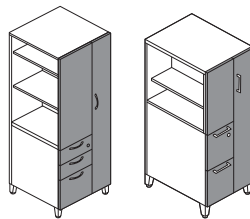

**Metal Side-Access Towers with Laminate
Fronts, Footed Base**

65", 50", 42"H
24", 18"W
24"D

NOTES:

- ❗ 18"W Tower models available in File/File configuration only.
- ❗ 24"W Tower models available in both Box/Box/File and File/File configurations.

CONTAIN[®] Lockers & Wardrobes

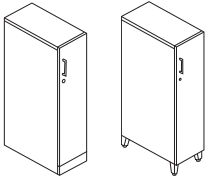

Wardrobe Tower with Metal Front

65", 50", 42"H
12"W
24", 18"D

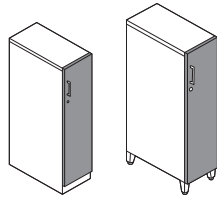

Wardrobe Tower with Laminate Front

65", 50", 42"H
12"W
24", 18"D

NOTES:

- Available with Plinth Base or Footed.
- Doors available hinged left or right.

STORAGE

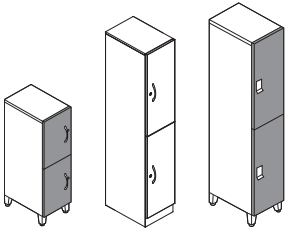

Double Locker, Metal or Laminate Fronts

65"H x 12"W x 18"D, Two Doors
45"H x 12"W x 18"D, Two Doors

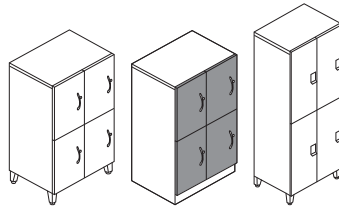

Quad Locker, Metal or Laminate Fronts

65"H x 24"W x 18"D, Four Doors
45"H x 24"W x 18"D, Four Doors

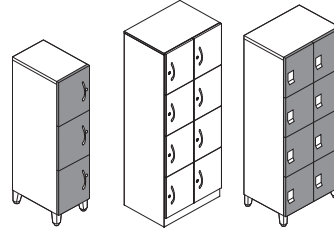

Cubby Locker, Metal or Laminate Fronts

65"H x 12"W x 18"D, Four Doors
50"H x 12"W x 18"D, Three Doors
65"H x 24"W x 18"D, Eight Doors
50"H x 24"W x 18"D, Six Doors

NOTES:

- Available with Flush or Recessed Plinth, or Footed.
- Doors available hinged left or right.
- Electronic Keypad or RFID Lock Pulls available to be specified on all sizes (upcharges apply).

CONTAIN® DIGITAL LOCK SPECIFICATIONS

Digital Keypad & RFID Lock Specification Information for Contain® Lockers

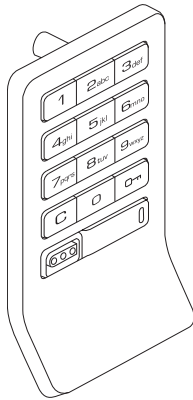

Keypad Lock Pull

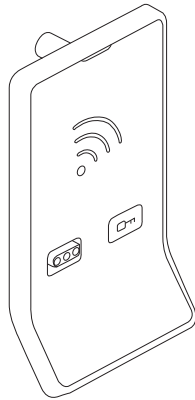

RFID Lock Pull

The digital keypad and RFID lock options support applications where workstations or storage areas are shared by multiple users. This is an alternative to a standard lock and key. This feature facilitates the use of storage by multiple users through eliminating the need to keep and hand-off physical keys. These locks ship in “shared mode” by default; shared mode indicates that the lock will “forget” the paired 4-digit code or RFID badge after the lock is opened, allowing the unit to be used by multiple users.

❗ Order at least one Programming Key and Manager Key per install.

Digital Keypad & RFID Locks:

- Offered on Contain® lockers.
- Ship factory installed.
- Integral Pull/Lock design replaces a specified pull on eLock models.
- Offered in a polished silver finish.
- Digital keypad lock requires input of a user-selected 4-digit code.
- RFID lock requires a compatible RFID card or sticker.
- Digital keypad locks and RFID locks are powered using 4 premium AA batteries.
- Battery life is dependent on the frequency of operation but can last up to 5-7 years.

RFID locks require user to present a compatible RFID card or sticker to the lock in order to gain access. This is the same technology as “badge” systems that allows employers to grant employees with cards that can be scanned to gain access to entrances and buildings. HON locks *may or may not be* compatible with these existing badge systems.

- For existing RFID badge system compatibility, badges must operate on a 13.56 MHz frequency with both iClass (ISO 15693) and Mifare (ISO 14443).
- If existing badge system is not compatible with 13.56 MHz frequency, compatible RFID badges or RFID stickers are sold separately as an accessory model.

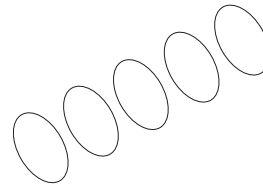

RFID Lock Pull

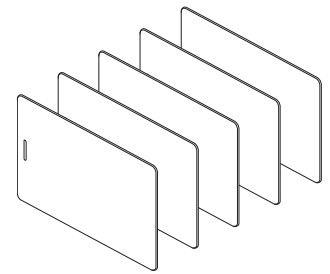

RFID Cards

Digital Lock Accessory Models (page 698)

- RFID-compatible cards and stickers are sold as accessory models in increments of 5, 25, or 100.
- RFID cards are plain white and have a lanyard cut.
- RFID stickers are plain white, approximately 1” in diameter and may be added to the back of an existing badge or employee identification card.
- **Every digital keypad or RFID installation site will require one Programming Key and at least one Manager Key, sold separately.**

Programming Key

- A Programming Key is a device used to initialize locks out of factory default mode and register Manager Keys to the locks.
- Only one Programming Key should be specified per installation site because multiple Programming Keys are not compatible with each other.
- Add-on digital lock orders should be programmed with the original Programming Key.
- Programming Key is the same key as Fuse™ Digilocks and can work across both Contain® and Fuse™.

Manager Key

- A Manager Key is used to bypass a locked unit; this operates as the “master key” and it is recommended that building facilitators have at least one Manager Key.
- Up to 6 Manager Keys may be registered to each lock.
- Manager Keys provide external power to locks in case of battery failure.

| Digital Lock Keys and Accessories | | |
|-----------------------------------|--------------|------------|
| Description | Model | List Price |
| Programming Key | HSLDIGPRG | \$160 |
| Manager Key | HSLDIGMGR | \$125 |
| 5 pk RFID Cards | HSLRFID5C | \$105 |
| 25 pk RFID Cards | HSLRFID25C | \$500 |
| 100 pk RFID Cards | HSLRFID100C | \$1,900 |
| 5 pk RFID Stickers | HSLRFID5S | \$55 |
| 25 pk RFID Stickers | HSLRFID25S | \$250 |
| 100 pk RFID Stickers | HSLRFID5100S | \$950 |

CONTAIN[®] Metal Personal Towers

GSA SIN 33721



Icon Legend on page 19

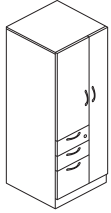

| DESCRIPTION | MODEL | SHIP WEIGHT | CUBE | LIST PRICE BY CASE PAINT GRADE | | |
|--|------------------------|-------------|------|--------------------------------|---------------|---------------|
| | | | | P1 | P2 | P3 |
| Personal Tower with Metal Fronts, Door/Box/Box/File | | | | | | |
| 65"H x 24"W x 24"D, Wardrobe Left | HSTP652424LBBFM | 178 | 27.2 | \$2266 | \$2343 | \$2411 |
| 65"H x 24"W x 24"D, Wardrobe Right | HSTP652424RBBFM | 178 | 27.2 | \$2266 | \$2343 | \$2411 |
| 50"H x 24"W x 24"D, Wardrobe Left | HSTP502424LBBFM | 146 | 21.2 | \$2120 | \$2197 | \$2265 |
| 50"H x 24"W x 24"D, Wardrobe Right | HSTP502424RBBFM | 146 | 21.2 | \$2120 | \$2197 | \$2265 |
| 42"H x 24"W x 24"D, Wardrobe Left | HSTP422424LBBFM | 132 | 16.8 | \$1822 | \$1872 | \$1947 |
| 42"H x 24"W x 24"D, Wardrobe Right | HSTP422424RBBFM | 132 | 16.8 | \$1822 | \$1872 | \$1947 |

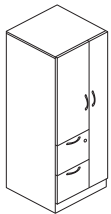

| | | | | | | |
|---|-----------------------|-----|------|---------------|---------------|---------------|
| Personal Tower with Metal Fronts, Door/File/File | | | | | | |
| 65"H x 24"W x 24"D, Wardrobe Left | HSTP652424LFFM | 178 | 27.2 | \$2208 | \$2285 | \$2353 |
| 65"H x 24"W x 24"D, Wardrobe Right | HSTP652424RFFM | 178 | 27.2 | \$2208 | \$2285 | \$2353 |
| 50"H x 24"W x 24"D, Wardrobe Left | HSTP502424LFFM | 146 | 21.1 | \$2065 | \$2142 | \$2210 |
| 50"H x 24"W x 24"D, Wardrobe Right | HSTP502424RFFM | 146 | 21.1 | \$2065 | \$2142 | \$2210 |
| 42"H x 24"W x 24"D, Wardrobe Left | HSTP422424LFFM | 132 | 16.8 | \$1765 | \$1815 | \$1890 |
| 42"H x 24"W x 24"D, Wardrobe Right | HSTP422424RFFM | 132 | 16.8 | \$1765 | \$1815 | \$1890 |

NOTES:

- Metal chassis and drawer fronts.
- Steel frame provides durability.
- Leveling glides can be adjusted from outside or inside the case.
- Heavy-duty, telescoping ball-bearing slides.
- Baked, epoxy/polyester, powder coating finish.
- One lock secures doors and drawers.
- Pencil tray standard in top box drawer.
- One box divider standard in each box drawer.
- One crossrail standard in each file drawer.

! Locking units equipped with HON "One Key" interchangeable core removable locks. Keyed alike core model HF23S, in Satin, must be ordered separately. See page 675.

HOW TO SPECIFY

| Select Model Number | Select Base | Select Pull | Select Case Paint | Select Front Paint | Select Lock |
|-------------------------------|---|--|-------------------|---|---|
| | BK Flush Plinth BX Recessed Plinth | A Arch PRO Silver R Radius N Integral S Square PR6 Silver | See page 666 | See page 666 NA Matches Case (+ \$0) P1 upcharge (+ \$150) P2 upcharge (+ \$170) P3 upcharge (+ \$190) | L Standard Lock X Omit Lock (- \$20) |
| H S T P 6 5 2 4 2 4 L F F M . | B X . | S P R 6 . | P 7 T . | N A . | L |



Icon Legend on page 19

CONTAIN[®] Metal Side Access Towers

| | DESCRIPTION | MODEL | SHIP WEIGHT | CUBE | LIST PRICE BY CASE PAINT GRADE | | |
|--|--|-------------------------|-------------|------|--------------------------------|---------------|---------------|
| | | | | | P1 | P2 | P3 |
| | Side Access Tower with Metal Fronts, Shelves/Box/Box/File | | | | | | |
| | 65"H x 24"W x 24"D, Wardrobe Left | HSTSP652424LBBFM | 178 | 27.2 | \$2399 | \$2476 | \$2544 |
| | 65"H x 24"W x 24"D, Wardrobe Right | HSTSP652424RBBFM | 178 | 27.2 | \$2399 | \$2476 | \$2544 |
| | 50"H x 24"W x 24"D, Wardrobe Left | HSTSP502424LBBFM | 146 | 21.2 | \$2247 | \$2324 | \$2392 |
| | 50"H x 24"W x 24"D, Wardrobe Right | HSTSP502424RBBFM | 146 | 21.2 | \$2247 | \$2324 | \$2392 |
| | 42"H x 24"W x 24"D, Wardrobe Left | HSTSP422424LBBFM | 132 | 16.8 | \$2027 | \$2077 | \$2152 |
| | 42"H x 24"W x 24"D, Wardrobe Right | HSTSP422424RBBFM | 132 | 16.8 | \$2027 | \$2077 | \$2152 |
| | Side Access Tower with Metal Fronts, Shelves/File/File | | | | | | |
| | 65"H x 24"W x 24"D, Wardrobe Left | HSTSP652424LFFM | 178 | 27.2 | \$2344 | \$2421 | \$2489 |
| | 65"H x 24"W x 24"D, Wardrobe Right | HSTSP652424RFFM | 178 | 27.2 | \$2344 | \$2421 | \$2489 |
| | 50"H x 24"W x 24"D, Wardrobe Left | HSTSP502424LFFM | 146 | 21.2 | \$2190 | \$2267 | \$2335 |
| | 50"H x 24"W x 24"D, Wardrobe Right | HSTSP502424RFFM | 146 | 21.2 | \$2190 | \$2267 | \$2335 |
| | 42"H x 24"W x 24"D, Wardrobe Left | HSTSP422424LFFM | 132 | 16.8 | \$1971 | \$2021 | \$2096 |
| | 42"H x 24"W x 24"D, Wardrobe Right | HSTSP422424RFFM | 132 | 16.8 | \$1971 | \$2021 | \$2096 |

NOTES:

- Towers can be used to support a worksurface. In order to do so, order bracket model HSTB2W1.
- Metal chassis and drawer fronts.
- Steel frame provides durability.
- Leveling glides can be adjusted from outside or inside the case.
- Heavy-duty, telescoping ball-bearing slides.
- Baked, epoxy/polyester, powder coating finish.
- One lock secures doors and drawers.
- Pencil tray standard in top box drawer.
- One box divider standard in each box drawer.
- One crossrail standard in each file drawer.

ⓘ Locking units equipped with HON "One Key" interchangeable core removable locks. Keyed alike core model HF23S, in Satin, must be ordered separately. See page 675.

STORAGE

HOW TO SPECIFY

| Select Model Number | Select Base | Select Pull | Select Case Paint | Select Front Paint | Select Panel Paint | Select Lock |
|---------------------|---|--|-------------------|---|------------------------|---|
| | BK Flush Plinth BX Recessed Plinth | A Arch PRO Silver R Radius N Integral S Square PR6 Silver | See page 666 | See page 666 NA Matches Case (+ \$0) P1 upcharge (+ \$150) P2 upcharge (+ \$170) P3 upcharge (+ \$190) | NA Matches Case | L Standard Lock X Omit Lock (- \$20) |
| HSTSP652424LFFM | BX | SPR6 | P7T | NA | NA | L |

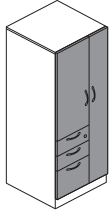

| DESCRIPTION | MODEL | SHIP WEIGHT | CUBE | LIST PRICE BY PAINT GRADE | | |
|---|------------------------|-------------|------|---------------------------|---------------|---------------|
| | | | | P1 | P2 | P3 |
| Personal Tower with Laminate Fronts, Door/Box/Box/File | | | | | | |
| 65"H x 24"W x 24"D, Wardrobe Left | HSTP652424LBBFL | 178 | 27.2 | \$2595 | \$2672 | \$2740 |
| 65"H x 24"W x 24"D, Wardrobe Right | HSTP652424RBBFL | 178 | 27.2 | \$2595 | \$2672 | \$2740 |
| 50"H x 24"W x 24"D, Wardrobe Left | HSTP502424LBBFL | 146 | 21.2 | \$2430 | \$2507 | \$2575 |
| 50"H x 24"W x 24"D, Wardrobe Right | HSTP502424RBBFL | 146 | 21.2 | \$2430 | \$2507 | \$2575 |
| 42"H x 24"W x 24"D, Wardrobe Left | HSTP422424LBBFL | 132 | 16.8 | \$2086 | \$2136 | \$2211 |
| 42"H x 24"W x 24"D, Wardrobe Right | HSTP422424RBBFL | 132 | 16.8 | \$2086 | \$2136 | \$2211 |

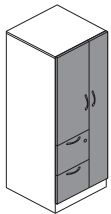

| DESCRIPTION | MODEL | SHIP WEIGHT | CUBE | LIST PRICE BY PAINT GRADE | | |
|--|-----------------------|-------------|------|---------------------------|---------------|---------------|
| | | | | P1 | P2 | P3 |
| Personal Tower with Laminate Fronts, Door/File/File | | | | | | |
| 65"H x 24"W x 24"D, Wardrobe Left | HSTP652424LFFL | 178 | 27.2 | \$2539 | \$2616 | \$2684 |
| 65"H x 24"W x 24"D, Wardrobe Right | HSTP652424RFFL | 178 | 27.2 | \$2539 | \$2616 | \$2684 |
| 50"H x 24"W x 24"D, Wardrobe Left | HSTP502424LFFL | 146 | 21.2 | \$2374 | \$2451 | \$2519 |
| 50"H x 24"W x 24"D, Wardrobe Right | HSTP502424RFFL | 146 | 21.2 | \$2374 | \$2451 | \$2519 |
| 42"H x 24"W x 24"D, Wardrobe Left | HSTP422424LFFL | 132 | 16.8 | \$2029 | \$2079 | \$2154 |
| 42"H x 24"W x 24"D, Wardrobe Right | HSTP422424RFFL | 132 | 16.8 | \$2029 | \$2079 | \$2154 |

STORAGE

NOTES:

- Metal chassis with laminate drawer/door fronts.
- Steel frame provides durability.
- Leveling glides can be adjusted from outside or inside the case.
- Heavy-duty, telescoping ball-bearing slides.
- Baked, epoxy/polyester, powder coating finish.
- One lock secures doors and drawers.
- Pencil tray standard in top box drawer.
- One box divider standard in each box drawer.
- One crossrail standard in each file drawer.

! Locking units equipped with HON "One Key" interchangeable core removable locks. Keyed alike core model HF23S, in Satin, must be ordered separately. See page 675.

HOW TO SPECIFY

| | | | | | |
|--|--|--|--|--|---|
| <p>Select Model Number</p> <p>H S T P 6 5 2 4 2 4 L F F L .</p> | <p>Select Base</p> <p>BX Recessed Plinth</p> <p>B X .</p> | <p>Select Pull</p> <p>A Arch PRO Silver S Square PR6 Silver</p> <p>S P R 6 .</p> | <p>Select Case Paint</p> <p>See page 666</p> <p>P 7 T .</p> | <p>Select Laminate</p> <p>See page 666</p> <p>L S A 1 .</p> | <p>Select Lock</p> <p>L Standard Lock X Omit Lock (- \$20)</p> <p>L</p> |
|--|--|--|--|--|---|



Icon Legend on page 19

Metal Side Access Towers with Laminate Fronts

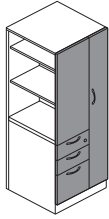

| DESCRIPTION | MODEL | SHIP WEIGHT | CUBE | LIST PRICE BY PAINT GRADE | | |
|---|-------------------------|-------------|------|---------------------------|---------------|---------------|
| | | | | P1 | P2 | P3 |
| Side Access Tower with Laminate Fronts, Shelves/Box/Box/File | | | | | | |
| 65”H x 24”W x 24”D, Wardrobe Left | HSTSP652424LBBFL | 178 | 27.2 | \$2750 | \$2827 | \$2895 |
| 65”H x 24”W x 24”D, Wardrobe Right | HSTSP652424RBBFL | 178 | 27.2 | \$2750 | \$2827 | \$2895 |
| 50”H x 24”W x 24”D, Wardrobe Left | HSTSP502424LBBFL | 146 | 21.2 | \$2574 | \$2651 | \$2719 |
| 50”H x 24”W x 24”D, Wardrobe Right | HSTSP502424RBBFL | 146 | 21.2 | \$2574 | \$2651 | \$2719 |
| 42”H x 24”W x 24”D, Wardrobe Left | HSTSP422424LBBFL | 132 | 16.8 | \$2322 | \$2372 | \$2447 |
| 42”H x 24”W x 24”D, Wardrobe Right | HSTSP422424RBBFL | 132 | 16.8 | \$2322 | \$2372 | \$2447 |

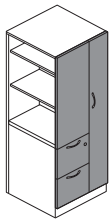

| DESCRIPTION | MODEL | SHIP WEIGHT | CUBE | LIST PRICE BY PAINT GRADE | | |
|--|------------------------|-------------|------|---------------------------|---------------|---------------|
| | | | | P1 | P2 | P3 |
| Side Access Tower with Laminate Fronts, Shelves/File/File | | | | | | |
| 65”H x 24”W x 24”D, Wardrobe Left | HSTSP652424LFFL | 178 | 27.2 | \$2695 | \$2772 | \$2840 |
| 65”H x 24”W x 24”D, Wardrobe Right | HSTSP652424RFFL | 178 | 27.2 | \$2695 | \$2772 | \$2840 |
| 50”H x 24”W x 24”D, Wardrobe Left | HSTSP502424LFFL | 146 | 21.2 | \$2519 | \$2596 | \$2664 |
| 50”H x 24”W x 24”D, Wardrobe Right | HSTSP502424RFFL | 146 | 21.2 | \$2519 | \$2596 | \$2664 |
| 42”H x 24”W x 24”D, Wardrobe Left | HSTSP422424LFFL | 132 | 16.8 | \$2267 | \$2317 | \$2392 |
| 42”H x 24”W x 24”D, Wardrobe Right | HSTSP422424RFFL | 132 | 16.8 | \$2267 | \$2317 | \$2392 |

NOTES:

- Towers can be used to support a worksurface. In order to do so, order bracket model HSTB2W1.
- Metal chassis with laminate drawer/door fronts.
- Steel frame provides durability.
- Leveling glides can be adjusted from outside or inside the case.
- Heavy-duty, telescoping ball-bearing slides.
- Baked, epoxy/polyester, powder coating finish.
- One lock secures doors and drawers.
- Pencil tray standard in top box drawer.
- One box divider standard in each box drawer.
- One crossrail standard in each file drawer.

! Locking units equipped with HON “One Key” interchangeable core removable locks. Keyed alike core model HF23S, in Satin, must be ordered separately. See page 675.

STORAGE

HOW TO SPECIFY

| | | | | | |
|--|--|---|--|--|--|
| <p>Select Model Number</p> <p>H S T S P 6 5 2 4 2 4 L F F L .</p> | <p>Select Base</p> <p>BX Recessed Plinth</p> <p>B X .</p> | <p>Select Pull</p> <p>A Arch PRO Silver S Square PR6 Silver</p> <p>S P R 6 .</p> | <p>Select Case Paint</p> <p>See page 666</p> <p>P 7 T .</p> | <p>Select Laminate</p> <p>See page 666</p> <p>L S A 1 .</p> | <p>Select Lock</p> <p>L Standard Lock X Omit Lock (- \$20)</p> <p>L</p> |
|--|--|---|--|--|--|

CONTAIN[®] Footed Metal Personal Towers

GSA SIN 33721



Icon Legend on page 19

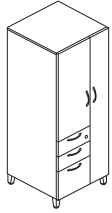

| DESCRIPTION | MODEL | SHIP WEIGHT | CUBE | LIST PRICE BY CASE PAINT GRADE | | |
|---|------------------------|-------------|------|--------------------------------|---------------|---------------|
| | | | | P1 | P2 | P3 |
| Footed Personal Tower with Metal Fronts, Door/Box/Box/File | | | | | | |
| 65"H x 24"W x 24"D, Wardrobe Left | HSTF652424LBBFM | 178 | 25.8 | \$2399 | \$2476 | \$2544 |
| 65"H x 24"W x 24"D, Wardrobe Right | HSTF652424RBBFM | 178 | 25.8 | \$2399 | \$2476 | \$2544 |
| 50"H x 24"W x 24"D, Wardrobe Left | HSTF502424LBBFM | 146 | 19.8 | \$2255 | \$2332 | \$2400 |
| 50"H x 24"W x 24"D, Wardrobe Right | HSTF502424RBBFM | 146 | 19.8 | \$2255 | \$2332 | \$2400 |
| 42"H x 24"W x 24"D, Wardrobe Left | HSTF422424LBBFM | 132 | 18.2 | \$1955 | \$2005 | \$2080 |
| 42"H x 24"W x 24"D, Wardrobe Right | HSTF422424RBBFM | 132 | 18.2 | \$1955 | \$2005 | \$2080 |

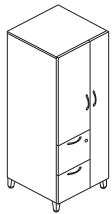

| DESCRIPTION | MODEL | SHIP WEIGHT | CUBE | LIST PRICE BY CASE PAINT GRADE | | |
|--|-----------------------|-------------|------|--------------------------------|---------------|---------------|
| | | | | P1 | P2 | P3 |
| Footed Personal Tower with Metal Fronts, Door/File/File | | | | | | |
| 65"H x 24"W x 24"D, Wardrobe Left | HSTF652424LFFM | 178 | 25.8 | \$2344 | \$2421 | \$2489 |
| 65"H x 24"W x 24"D, Wardrobe Right | HSTF652424RFFM | 178 | 25.8 | \$2344 | \$2421 | \$2489 |
| 50"H x 24"W x 24"D, Wardrobe Left | HSTF502424LFFM | 146 | 19.8 | \$2199 | \$2276 | \$2344 |
| 50"H x 24"W x 24"D, Wardrobe Right | HSTF502424RFFM | 146 | 19.8 | \$2199 | \$2276 | \$2344 |
| 42"H x 24"W x 24"D, Wardrobe Left | HSTF422424LFFM | 132 | 18.2 | \$1900 | \$1950 | \$2025 |
| 42"H x 24"W x 24"D, Wardrobe Right | HSTF422424RFFM | 132 | 18.2 | \$1900 | \$1950 | \$2025 |

NOTES:

- Metal chassis and drawer fronts.
- Steel frame provides durability.
- Leveling glides can be adjusted from outside or inside the case.
- Heavy-duty, telescoping ball-bearing slides.
- Baked, epoxy/polyester, powder coating finish.
- One lock secures doors and drawers.
- Pencil tray standard in top box drawer.
- One box divider standard in each box drawer.
- One crossrail standard in each file drawer.

ⓘ Locking units equipped with HON "One Key" interchangeable core removable locks. Keyed alike core model HF23S, in Satin, must be ordered separately. See page 675.

HOW TO SPECIFY

| | | | | | |
|---|---|--|--|---|--|
| Select Model Number H S T F 4 2 2 4 2 4 L B B F M . | Select Foot SF Contain Foot T1 Platinum Metallic PR6 Silver | Select Pull A Arch PRO Silver R Radius N Integral S Square PR6 Silver | Select Paint Color See page 666 P 7 T . | Select Front Paint See page 666 NA Matches Case (+ \$0) P1 upcharge (+ \$150) P2 upcharge (+ \$170) P3 upcharge (+ \$190) | Select Lock L Standard Lock X Omit Lock (- \$20) L |
|---|---|--|--|---|--|



Icon Legend on page 19

Footed Metal Side Access Towers

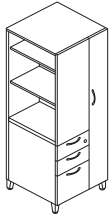

| DESCRIPTION | MODEL | SHIP WEIGHT | CUBE | LIST PRICE BY CASE PAINT GRADE | | |
|---|-------------------------|-------------|------|--------------------------------|---------------|---------------|
| | | | | P1 | P2 | P3 |
| Footed Side Access Tower with Metal Fronts, Shelves/Box/Box/File | | | | | | |
| 65”H x 24”W x 24”D, Wardrobe Left | HSTSF652424LBBFM | 178 | 25.8 | \$2534 | \$2611 | \$2679 |
| 65”H x 24”W x 24”D, Wardrobe Right | HSTSF652424RBBFM | 178 | 25.8 | \$2534 | \$2611 | \$2679 |
| 50”H x 24”W x 24”D, Wardrobe Left | HSTSF502424LBBFM | 146 | 19.8 | \$2380 | \$2457 | \$2525 |
| 50”H x 24”W x 24”D, Wardrobe Right | HSTSF502424RBBFM | 146 | 19.8 | \$2380 | \$2457 | \$2525 |
| 42”H x 24”W x 24”D, Wardrobe Left | HSTSF422424LBBFM | 132 | 18.2 | \$2162 | \$2212 | \$2287 |
| 42”H x 24”W x 24”D, Wardrobe Right | HSTSF422424RBBFM | 132 | 18.2 | \$2162 | \$2212 | \$2287 |

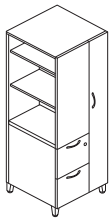

| DESCRIPTION | MODEL | SHIP WEIGHT | CUBE | LIST PRICE BY CASE PAINT GRADE | | |
|--|------------------------|-------------|------|--------------------------------|---------------|---------------|
| | | | | P1 | P2 | P3 |
| Footed Side Access Tower with Metal Fronts, Shelves/File/File | | | | | | |
| 65”H x 24”W x 24”D, Wardrobe Left | HSTSF652424LFFM | 178 | 25.8 | \$2478 | \$2555 | \$2623 |
| 65”H x 24”W x 24”D, Wardrobe Right | HSTSF652424RFFM | 178 | 25.8 | \$2478 | \$2555 | \$2623 |
| 50”H x 24”W x 24”D, Wardrobe Left | HSTSF502424LFFM | 146 | 19.8 | \$2324 | \$2401 | \$2469 |
| 50”H x 24”W x 24”D, Wardrobe Right | HSTSF502424RFFM | 146 | 19.8 | \$2324 | \$2401 | \$2469 |
| 42”H x 24”W x 24”D, Wardrobe Left | HSTSF422424LFFM | 132 | 18.2 | \$2106 | \$2156 | \$2231 |
| 42”H x 24”W x 24”D, Wardrobe Right | HSTSF422424RFFM | 132 | 18.2 | \$2106 | \$2156 | \$2231 |

NOTES:

- Towers can be used to support a worksurface. In order to do so, order bracket model HSTB2W1.
- Metal chassis and drawer fronts.
- Steel frame provides durability.
- Leveling glides can be adjusted from outside or inside the case.
- Heavy-duty, telescoping ball-bearing slides.
- Baked, epoxy/polyester, powder coating finish.
- One lock secures doors and drawers.
- Pencil tray standard in top box drawer.
- One box divider standard in each box drawer.
- One crossrail standard in each file drawer.

! Locking units equipped with HON “One Key” interchangeable core removable locks. Keyed alike core model HF23S, in Satin, must be ordered separately. See page 675.

STORAGE

HOW TO SPECIFY

| Select Model Number | Select Foot | Select Pull | Select Paint Color | Select Front Paint | Select Panel Paint | Select Lock |
|-------------------------|--|--|--------------------|---|------------------------|---|
| | SF Contain Foot T1 Platinum Metallic PR6 Silver | A Arch PRO Silver R Radius N Integral S Square PR6 Silver | See page 666 | See page 666 NA Matches Case (+ \$0) P1 upcharge (+ \$150) P2 upcharge (+ \$170) P3 upcharge (+ \$190) | NA Matches Case | L Standard Lock X Omit Lock (- \$20) |
| HSTSF422424RBBFM | SFT1 | SPR6 | P7T | NA | NA | L |

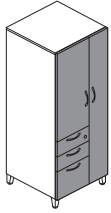

| DESCRIPTION | MODEL | SHIP WEIGHT | CUBE | LIST PRICE BY PAINT GRADE | | |
|--|------------------------|-------------|------|---------------------------|---------------|---------------|
| | | | | P1 | P2 | P3 |
| Footed Personal Tower with Laminate Fronts, Door/Box/Box/File | | | | | | |
| 65"H x 24"W x 24"D, Wardrobe Left | HSTF652424LBBFL | 178 | 25.8 | \$2730 | \$2807 | \$2875 |
| 65"H x 24"W x 24"D, Wardrobe Right | HSTF652424RBBFL | 178 | 25.8 | \$2730 | \$2807 | \$2875 |
| 50"H x 24"W x 24"D, Wardrobe Left | HSTF502424LBBFL | 146 | 19.8 | \$2564 | \$2641 | \$2709 |
| 50"H x 24"W x 24"D, Wardrobe Right | HSTF502424RBBFL | 146 | 19.8 | \$2564 | \$2641 | \$2709 |
| 42"H x 24"W x 24"D, Wardrobe Left | HSTF422424LBBFL | 132 | 18.2 | \$2220 | \$2270 | \$2345 |
| 42"H x 24"W x 24"D, Wardrobe Right | HSTF422424RBBFL | 132 | 18.2 | \$2220 | \$2270 | \$2345 |

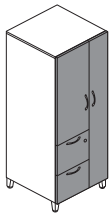

| DESCRIPTION | MODEL | SHIP WEIGHT | CUBE | LIST PRICE BY PAINT GRADE | | |
|---|-----------------------|-------------|------|---------------------------|---------------|---------------|
| | | | | P1 | P2 | P3 |
| Footed Personal Tower with Laminate Fronts, Door/File/File | | | | | | |
| 65"H x 24"W x 24"D, Wardrobe Left | HSTF652424LFFL | 178 | 25.8 | \$2674 | \$2751 | \$2819 |
| 65"H x 24"W x 24"D, Wardrobe Right | HSTF652424RFFL | 178 | 25.8 | \$2674 | \$2751 | \$2819 |
| 50"H x 24"W x 24"D, Wardrobe Left | HSTF502424LFFL | 146 | 19.8 | \$2507 | \$2584 | \$2652 |
| 50"H x 24"W x 24"D, Wardrobe Right | HSTF502424RFFL | 146 | 19.8 | \$2507 | \$2584 | \$2652 |
| 42"H x 24"W x 24"D, Wardrobe Left | HSTF422424LFFL | 132 | 18.2 | \$2165 | \$2215 | \$2290 |
| 42"H x 24"W x 24"D, Wardrobe Right | HSTF422424RFFL | 132 | 18.2 | \$2165 | \$2215 | \$2290 |

STORAGE

NOTES:

- Metal chassis with laminate drawer/door fronts.
- Steel frame provides durability.
- Leveling glides can be adjusted from outside or inside the case.
- Heavy-duty, telescoping ball-bearing slides.
- Baked, epoxy/polyester, powder coating finish.
- One lock secures doors and drawers.
- Pencil tray standard in top box drawer.
- One box divider standard in each box drawer.
- One crossrail standard in each file drawer.

! Locking units equipped with HON "One Key" interchangeable core removable locks. Keyed alike core model HF23S, in Satin, must be ordered separately. See page 675.

HOW TO SPECIFY

| Select Model Number | Select Foot | Select Pull | Select Case Paint | Select Laminate | Select Lock |
|---|--|--------------|-------------------|---|-------------|
| SF Contain Foot T1 Platinum Metallic PR6 Silver | A Arch PRO Silver S Square PR6 Silver | See page 666 | See page 666 | L Standard Lock X Omit Lock (- \$20) | |
| HSTF652424LBBFL | SFT1 | SPR6 | P7T | LSA1 | L |



Icon Legend on page 19

Footed Metal Side Access Towers with Laminate Fronts

| | DESCRIPTION | MODEL | SHIP WEIGHT | CUBE | LIST PRICE BY PAINT GRADE | | |
|--|--|-------------------------|-------------|------|---------------------------|---------------|---------------|
| | | | | | P1 | P2 | P3 |
| | Footed Side Access Tower with Laminate Fronts, Shelves/Box/Box/File | | | | | | |
| | 65”H x 24”W x 24”D, Wardrobe Left | HSTSF652424LBBFL | 178 | 25.8 | \$2885 | \$2962 | \$3030 |
| | 65”H x 24”W x 24”D, Wardrobe Right | HSTSF652424RBBFL | 178 | 25.8 | \$2885 | \$2962 | \$3030 |
| | 50”H x 24”W x 24”D, Wardrobe Left | HSTSF502424LBBFL | 146 | 19.8 | \$2709 | \$2786 | \$2854 |
| | 50”H x 24”W x 24”D, Wardrobe Right | HSTSF502424RBBFL | 146 | 19.8 | \$2709 | \$2786 | \$2854 |
| | 42”H x 24”W x 24”D, Wardrobe Left | HSTSF422424LBBFL | 132 | 18.2 | \$2457 | \$2507 | \$2582 |
| | 42”H x 24”W x 24”D, Wardrobe Right | HSTSF422424RBBFL | 132 | 18.2 | \$2457 | \$2507 | \$2582 |
| | Footed Side Access Tower with Laminate Fronts, Shelves/File/File | | | | | | |
| | 65”H x 24”W x 24”D, Wardrobe Left | HSTSF652424LFFL | 178 | 25.8 | \$2829 | \$2906 | \$2974 |
| | 65”H x 24”W x 24”D, Wardrobe Right | HSTSF652424RFFL | 178 | 25.8 | \$2829 | \$2906 | \$2974 |
| | 50”H x 24”W x 24”D, Wardrobe Left | HSTSF502424LFFL | 146 | 19.8 | \$2653 | \$2730 | \$2798 |
| | 50”H x 24”W x 24”D, Wardrobe Right | HSTSF502424RFFL | 146 | 19.8 | \$2653 | \$2730 | \$2798 |
| | 42”H x 24”W x 24”D, Wardrobe Left | HSTSF422424LFFL | 132 | 18.2 | \$2400 | \$2450 | \$2525 |
| | 42”H x 24”W x 24”D, Wardrobe Right | HSTSF422424RFFL | 132 | 18.2 | \$2400 | \$2450 | \$2525 |
| | Tower Kickplates (Field Installable) | | | | | | |
| | For 24” Tower, Left | HSTAKL | 2 | 0.3 | \$179 | \$187 | \$192 |
| | For 24” Tower, Right | HSTAKR | 2 | 0.3 | \$179 | \$187 | \$192 |
| | Specify: Model.Paint | | | | | | |
| | SPECIFYING EXAMPLE: HSATKL.P | | | | | | |

STORAGE

NOTES:

- Towers can be used to support a worksurface. In order to do so, order bracket model HSTB2W1.
 - Metal chassis with laminate drawer/door fronts.
 - Steel frame provides durability.
 - Leveling glides can be adjusted from outside or inside the case.
 - Heavy-duty, telescoping ball-bearing slides.
 - Baked, epoxy/polyester, powder coating finish.
 - One lock secures doors and drawers.
 - Pencil tray standard in top box drawer.
 - One box divider standard in each box drawer.
 - One crossrail standard in each file drawer.
- ⚠ Locking units equipped with HON “One Key” interchangeable core removable locks. Keyed alike core model HF23S, in Satin, must be ordered separately. See page 675.

HOW TO SPECIFY

| | | | | | |
|----------------------------|---|--|--------------------------|------------------------|---|
| Select Model Number | Select Foot | Select Pull | Select Case Paint | Select Laminate | Select Lock |
| | SF Contain Foot T1 Platinum Metallic PR6 Silver | A Arch PRO Silver S Square PR6 Silver | See page 666 | See page 666 | L Standard Lock X Omit Lock (- \$20) |
| HSTSF652424LBBFL | SFT1 | SPR6 | P7T | LSA1 | L |

CONTAIN[®] 18"W Slim Metal Personal Towers

GSA SIN 33721

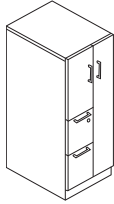

| DESCRIPTION | MODEL | SHIP WEIGHT | CUBE | LIST PRICE BY CASE PAINT GRADE | | |
|--|-----------------------|-------------|------|--------------------------------|---------------|---------------|
| | | | | P1 | P2 | P3 |
| 18"W Slim Personal Tower, Plinth w/Metal Fronts | | | | | | |
| 65"H x 18"W x 24"D, Left Hand | HSTP651824LFFM | 148 | 19.4 | \$1945 | \$2022 | \$2090 |
| 65"H x 18"W x 24"D, Right Hand | HSTP651824RFFM | 148 | 19.4 | \$1945 | \$2022 | \$2090 |
| 50"H x 18"W x 24"D, Left Hand | HSTP501824LFFM | 121 | 16.0 | \$1817 | \$1894 | \$1962 |
| 50"H x 18"W x 24"D, Right Hand | HSTP501824RFFM | 121 | 16.0 | \$1817 | \$1894 | \$1962 |
| 42"H x 18"W x 24"D, Left Hand | HSTP421824LFFM | 109 | 13.7 | \$1553 | \$1603 | \$1678 |
| 42"H x 18"W x 24"D, Right Hand | HSTP421824RFFM | 109 | 13.7 | \$1553 | \$1603 | \$1678 |

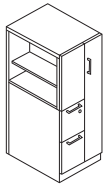

| DESCRIPTION | MODEL | SHIP WEIGHT | CUBE | LIST PRICE BY CASE PAINT GRADE | | |
|--|------------------------|-------------|------|--------------------------------|---------------|---------------|
| | | | | P1 | P2 | P3 |
| 18"W Slim Side Access Tower, Plinth, Metal Fronts | | | | | | |
| 65"H x 18"W x 24"D, Left Hand | HSTSP651824LFFM | 148 | 19.4 | \$2061 | \$2138 | \$2206 |
| 65"H x 18"W x 24"D, Right Hand | HSTSP651824RFFM | 148 | 19.4 | \$2061 | \$2138 | \$2206 |
| 50"H x 18"W x 24"D, Left Hand | HSTSP501824LFFM | 121 | 16.0 | \$1928 | \$2005 | \$2073 |
| 50"H x 18"W x 24"D, Right Hand | HSTSP501824RFFM | 121 | 16.0 | \$1928 | \$2005 | \$2073 |
| 42"H x 18"W x 24"D, Left Hand | HSTSP421824LFFM | 109 | 13.7 | \$1735 | \$1785 | \$1860 |
| 42"H x 18"W x 24"D, Right Hand | HSTSP421824RFFM | 109 | 13.7 | \$1735 | \$1785 | \$1860 |

NOTES:

- Towers can be used to support a worksurface. In order to do so, order bracket model HSTB2W1.
- Metal chassis and drawer fronts.
- Steel frame provides durability.
- Leveling glides can be adjusted from outside or inside the case.
- Heavy-duty, telescoping ball-bearing slides.
- Baked, epoxy/polyester, powder coating finish.
- One lock secures doors and drawers.
- One crossrail standard in each file drawer.

! Locking units equipped with HON "One Key" interchangeable core removable locks. Keyed alike core model HF23S, in Satin, must be ordered separately. See page 675.

HOW TO SPECIFY

| | | | | | |
|---|---|--|---|---|---|
| Select Model Number H S T P 6 5 1 8 2 4 L F F M . | Select Base BK Flush Plinth BX Recessed Plinth | Select Pull A Arch PRO Silver N Integral S Square PR6 Silver | Select Paint Color See page 666 | Select Front Paint See page 666 NA Matches Case (+ \$0) P1 upcharge (+ \$150) P2 upcharge (+ \$170) P3 upcharge (+ \$190) | Select Lock L Standard Lock X Omit Lock (- \$20) |
|---|---|--|---|---|---|

| | | | | | | |
|---|---|--|--|---|--|---|
| Select Model Number H S T S P 6 5 1 8 2 4 L F F M . | Select Base BK Flush Plinth BX Recessed Plinth | Select Pull A Arch PRO Silver N Integral S Square PR6 Silver | Select Case Paint See page 666 | Select Front Paint See page 666 NA Matches Case (+ \$0) P1 upcharge (+ \$150) P2 upcharge (+ \$170) P3 upcharge (+ \$190) | Select Panel Paint NA Matches Case | Select Lock L Standard Lock X Omit Lock (- \$20) |
|---|---|--|--|---|--|---|



Icon Legend on page 19

18"W Slim Metal Personal Towers

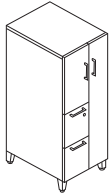

| DESCRIPTION | MODEL | SHIP WEIGHT | CUBE | LIST PRICE BY CASE PAINT GRADE | | |
|--|-----------------------|-------------|------|--------------------------------|---------------|---------------|
| | | | | P1 | P2 | P3 |
| 18"W Slim Personal Tower, Footed w/Metal Fronts | | | | | | |
| 65"H x 18"W x 24"D, Left Hand | HSTF651824LFFM | 148 | 19.4 | \$2079 | \$2156 | \$2224 |
| 65"H x 18"W x 24"D, Right Hand | HSTF651824RFFM | 148 | 19.4 | \$2079 | \$2156 | \$2224 |
| 50"H x 18"W x 24"D, Left Hand | HSTF501824LFFM | 121 | 14.9 | \$1951 | \$2028 | \$2096 |
| 50"H x 18"W x 24"D, Right Hand | HSTF501824RFFM | 121 | 14.9 | \$1951 | \$2028 | \$2096 |
| 42"H x 18"W x 24"D, Left Hand | HSTF421824LFFM | 109 | 12.6 | \$1688 | \$1738 | \$1813 |
| 42"H x 18"W x 24"D, Right Hand | HSTF421824RFFM | 109 | 12.6 | \$1688 | \$1738 | \$1813 |

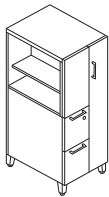

| | | | | | | |
|---|------------------------|-----|------|---------------|---------------|---------------|
| 18"W Slim Side Access Tower, Footed w/Metal Fronts | | | | | | |
| 65"H x 18"W x 24"D, Left Hand | HSTSF651824LFFM | 148 | 19.4 | \$2197 | \$2274 | \$2342 |
| 65"H x 18"W x 24"D, Right Hand | HSTSF651824RFFM | 148 | 19.4 | \$2197 | \$2274 | \$2342 |
| 50"H x 18"W x 24"D, Left Hand | HSTSF501824LFFM | 121 | 14.9 | \$2061 | \$2138 | \$2206 |
| 50"H x 18"W x 24"D, Right Hand | HSTSF501824RFFM | 121 | 14.9 | \$2061 | \$2138 | \$2206 |
| 42"H x 18"W x 24"D, Left Hand | HSTSF421824LFFM | 109 | 12.6 | \$1869 | \$1919 | \$1994 |
| 42"H x 18"W x 24"D, Right Hand | HSTSF421824RFFM | 109 | 12.6 | \$1869 | \$1919 | \$1994 |

NOTES:

- Towers can be used to support a worksurface. In order to do so, order bracket model HSTB2W1.
- Metal chassis and drawer fronts.
- Steel frame provides durability.
- Leveling glides can be adjusted from outside or inside the case.
- Heavy-duty, telescoping ball-bearing slides.
- Baked, epoxy/polyester, powder coating finish.
- One lock secures doors and drawers.
- One crossrail standard in each file drawer.

ⓘ Locking units equipped with HON "One Key" interchangeable core removable locks. Keyed alike core model HF23S, in Satin, must be ordered separately. See page 675.

STORAGE

HOW TO SPECIFY

| | | | | | |
|--|---|--|---|---|--|
| <p>Select Model Number</p> <p>H S T F 6 5 1 8 2 4 L F F M .</p> | <p>Select Foot</p> <p>SF Contain Foot T1 Platinum Metallic PR6 Silver</p> <p>S F T 1 .</p> | <p>Select Pull</p> <p>A Arch PRO Silver N Integral S Square PR6 Silver</p> <p>S P R 6 .</p> | <p>Select Paint Color</p> <p>See page 666</p> <p>P 7 T .</p> | <p>Select Front Paint</p> <p>See page 666 NA Matches Case (+ \$0) P1 upcharge (+ \$150) P2 upcharge (+ \$170) P3 upcharge (+ \$190)</p> <p>N A .</p> | <p>Select Lock</p> <p>L Standard Lock X Omit Lock (- \$20)</p> <p>L</p> |
|--|---|--|---|---|--|

| | | | | | | |
|--|---|--|--|---|--|--|
| <p>Select Model Number</p> <p>H S T S F 6 5 1 8 2 4 L F F M .</p> | <p>Select Foot</p> <p>SF Contain Foot T1 Platinum Metallic PR6 Silver</p> <p>S F T 1 .</p> | <p>Select Pull</p> <p>A Arch PRO Silver N Integral S Square PR6 Silver</p> <p>S P R 6 .</p> | <p>Select Case Paint</p> <p>See page 666</p> <p>P 7 T .</p> | <p>Select Front Paint</p> <p>See page 666 NA Matches Case (+ \$0) P1 upcharge (+ \$150) P2 upcharge (+ \$170) P3 upcharge (+ \$190)</p> <p>N A .</p> | <p>Select Panel Paint</p> <p>NA Matches Case</p> <p>N A .</p> | <p>Select Lock</p> <p>L Standard Lock X Omit Lock (- \$20)</p> <p>L</p> |
|--|---|--|--|---|--|--|

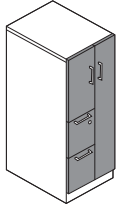

| DESCRIPTION | MODEL | SHIP WEIGHT | CUBE | LIST PRICE BY PAINT GRADE | | |
|---|-----------------------|-------------|------|---------------------------|---------------|---------------|
| | | | | P1 | P2 | P3 |
| 18"W Slim Personal Tower, Plinth w/Laminate Fronts | | | | | | |
| 65"H x 18"W x 24"D, Left Hand | HSTP651824LFFL | 148 | 19.4 | \$2235 | \$2312 | \$2380 |
| 65"H x 18"W x 24"D, Right Hand | HSTP651824RFFL | 148 | 19.4 | \$2235 | \$2312 | \$2380 |
| 50"H x 18"W x 24"D, Left Hand | HSTP501824LFFL | 121 | 16.0 | \$2090 | \$2167 | \$2235 |
| 50"H x 18"W x 24"D, Right Hand | HSTP501824RFFL | 121 | 16.0 | \$2090 | \$2167 | \$2235 |
| 42"H x 18"W x 24"D, Left Hand | HSTP421824LFFL | 109 | 13.7 | \$1786 | \$1836 | \$1911 |
| 42"H x 18"W x 24"D, Right Hand | HSTP421824RFFL | 109 | 13.7 | \$1786 | \$1836 | \$1911 |

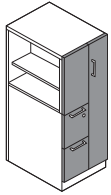

| DESCRIPTION | MODEL | SHIP WEIGHT | CUBE | LIST PRICE BY PAINT GRADE | | |
|---|------------------------|-------------|------|---------------------------|---------------|---------------|
| | | | | P1 | P2 | P3 |
| 18"W Slim Side Access Tower, Plinth, Laminate Fronts | | | | | | |
| 65"H x 18"W x 24"D, Left Hand | HSTSP651824LFFL | 148 | 19.4 | \$2372 | \$2449 | \$2517 |
| 65"H x 18"W x 24"D, Right Hand | HSTSP651824RFFL | 148 | 19.4 | \$2372 | \$2449 | \$2517 |
| 50"H x 18"W x 24"D, Left Hand | HSTSP501824LFFL | 121 | 16.0 | \$2216 | \$2293 | \$2361 |
| 50"H x 18"W x 24"D, Right Hand | HSTSP501824RFFL | 121 | 16.0 | \$2216 | \$2293 | \$2361 |
| 42"H x 18"W x 24"D, Left Hand | HSTSP421824LFFL | 109 | 13.7 | \$1995 | \$2045 | \$2120 |
| 42"H x 18"W x 24"D, Right Hand | HSTSP421824RFFL | 109 | 13.7 | \$1995 | \$2045 | \$2120 |

STORAGE

NOTES:

- Towers can be used to support a worksurface. In order to do so, order bracket model HSTB2W1.
- Metal chassis with laminate drawer/door fronts.
- Steel frame provides durability.
- Leveling glides can be adjusted from outside or inside the case.
- Heavy-duty, telescoping ball-bearing slides.
- Baked, epoxy/polyester, powder coating finish.
- One lock secures doors and drawers.
- One crossrail standard in each file drawer.

! Locking units equipped with HON "One Key" interchangeable core removable locks. Keyed alike core model HF23S, in Satin, must be ordered separately. See page 675.

HOW TO SPECIFY

| | | | | | |
|--|--|---|--|--|--|
| <p>Select Model Number</p> <p>H S T S P 6 5 1 8 2 4 L F F L .</p> | <p>Select Base</p> <p>BX Recessed Plinth</p> <p>B X .</p> | <p>Select Pull</p> <p>A Arch PRO Silver S Square PR6 Silver</p> <p>S P R 6 .</p> | <p>Select Case Paint</p> <p>See page 666</p> <p>P 7 T .</p> | <p>Select Laminate</p> <p>See page 666</p> <p>L S A 1 .</p> | <p>Select Lock</p> <p>L Standard Lock X Omit Lock (- \$20)</p> <p>L</p> |
|--|--|---|--|--|--|



Icon Legend on page 19

18"W Slim Personal Towers with Laminate Fronts

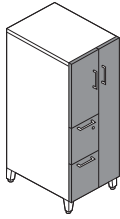

DESCRIPTION

MODEL

SHIP WEIGHT CUBE

LIST PRICE BY PAINT GRADE
P1 P2 P3

18"W Slim Personal Tower, Footed w/Laminate Fronts

65"H x 18"W x 24"D, Left Hand
65"H x 18"W x 24"D, Right Hand

HSTF651824LFFL
HSTF651824RFFL

148
148

19.4
19.4

\$2371 **\$2448** **\$2516**
\$2371 **\$2448** **\$2516**

50"H x 18"W x 24"D, Left Hand
50"H x 18"W x 24"D, Right Hand

HSTF501824LFFL
HSTF501824RFFL

121
121

16.0
16.0

\$2223 **\$2300** **\$2368**
\$2223 **\$2300** **\$2368**

42"H x 18"W x 24"D, Left Hand
42"H x 18"W x 24"D, Right Hand

HSTF421824LFFL
HSTF421824RFFL

109
109

13.7
13.7

\$1921 **\$1971** **\$2046**
\$1921 **\$1971** **\$2046**

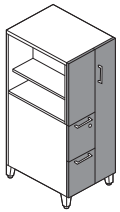

18"W Slim Side Access Tower, Footed, Laminate Fronts

65"H x 18"W x 24"D, Left Hand
65"H x 18"W x 24"D, Right Hand

HSTSF651824LFFL
HSTSF651824RFFL

148
148

19.4
19.4

\$2505 **\$2582** **\$2650**
\$2505 **\$2582** **\$2650**

50"H x 18"W x 24"D, Left Hand
50"H x 18"W x 24"D, Right Hand

HSTSF501824LFFL
HSTSF501824RFFL

121
121

14.9
14.9

\$2351 **\$2428** **\$2496**
\$2351 **\$2428** **\$2496**

42"H x 18"W x 24"D, Left Hand
42"H x 18"W x 24"D, Right Hand

HSTSF421824LFFL
HSTSF421824RFFL

109
109

12.6
12.6

\$2129 **\$2179** **\$2254**
\$2129 **\$2179** **\$2254**

NOTES:

- Towers can be used to support a worksurface. In order to do so, order bracket model HSTB2W1.
- Metal chassis with laminate drawer/door fronts.
- Steel frame provides durability.
- Leveling glides can be adjusted from outside or inside the case.
- Heavy-duty, telescoping ball-bearing slides.
- Baked, epoxy/polyester, powder coating finish.
- One lock secures doors and drawers.
- One crossrail standard in each file drawer.

ⓘ Locking units equipped with HON "One Key" interchangeable core removable locks. Keyed alike core model HF23S, in Satin, must be ordered separately. See page 675.

STORAGE

HOW TO SPECIFY

| | | | | | |
|----------------------------|---|--|--------------------------|------------------------|---|
| Select Model Number | Select Foot | Select Pull | Select Case Paint | Select Laminate | Select Lock |
| | SF Contain Foot T1 Platinum Metallic PR6 Silver | A Arch PRO Silver S Square PR6 Silver | See page 666 | See page 666 | L Standard Lock X Omit Lock (- \$20) |
| HSTSF651824LFFL | SFT1 | SPR6 | P7T | LSA1 | L |

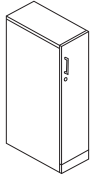

| DESCRIPTION | MODEL | SHIP WEIGHT | CUBE | LIST PRICE BY CASE PAINT GRADE | | |
|--|---------------------|-------------|------|--------------------------------|--------|--------|
| | | | | P1 | P2 | P3 |
| Wardrobe Tower, Plinth w/Metal Fronts | | | | | | |
| 65"H x 12"W x 24"D, Right Hand | HSWP651224RM | 108 | 14.8 | \$1248 | \$1325 | \$1393 |
| 65"H x 12"W x 24"D, Left Hand | HSWP651224LM | 108 | 14.8 | \$1248 | \$1325 | \$1393 |
| 50"H x 12"W x 24"D, Right Hand | HSWP501224RM | 87 | 11.5 | \$1155 | \$1232 | \$1300 |
| 50"H x 12"W x 24"D, Left Hand | HSWP501224LM | 87 | 11.5 | \$1155 | \$1232 | \$1300 |
| 42"H x 12"W x 24"D, Right Hand | HSWP421224RM | 77 | 9.9 | \$964 | \$1014 | \$1089 |
| 42"H x 12"W x 24"D, Left Hand | HSWP421224LM | 77 | 9.9 | \$964 | \$1014 | \$1089 |
| 65"H x 12"W x 18"D, Right Hand | | | | | | |
| 65"H x 12"W x 18"D, Left Hand | HSWP651218LM | 108 | 14.8 | \$1145 | \$1222 | \$1290 |
| 50"H x 12"W x 18"D, Right Hand | HSWP501218RM | 87 | 11.5 | \$1060 | \$1137 | \$1205 |
| 50"H x 12"W x 18"D, Left Hand | HSWP501218LM | 87 | 11.5 | \$1060 | \$1137 | \$1205 |
| 42"H x 12"W x 18"D, Right Hand | HSWP421218RM | 77 | 9.9 | \$885 | \$935 | \$1010 |
| 42"H x 12"W x 18"D, Left Hand | HSWP421218LM | 77 | 9.9 | \$885 | \$935 | \$1010 |

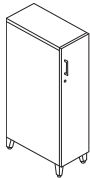

| | | | | | | |
|--|---------------------|-----|------|--------|--------|--------|
| Wardrobe Tower, Footed w/Metal Fronts | | | | | | |
| 65"H x 12"W x 24"D, Right Hand | HSWF651224RM | 108 | 14.1 | \$1383 | \$1460 | \$1528 |
| 65"H x 12"W x 24"D, Left Hand | HSWF651224LM | 108 | 14.1 | \$1383 | \$1460 | \$1528 |
| 50"H x 12"W x 24"D, Right Hand | HSWF501224RM | 87 | 10.8 | \$1291 | \$1368 | \$1436 |
| 50"H x 12"W x 24"D, Left Hand | HSWF501224LM | 87 | 10.8 | \$1291 | \$1368 | \$1436 |
| 42"H x 12"W x 24"D, Right Hand | HSWF421224RM | 77 | 9.1 | \$1099 | \$1149 | \$1224 |
| 42"H x 12"W x 24"D, Left Hand | HSWF421224LM | 77 | 9.1 | \$1099 | \$1149 | \$1224 |
| 65"H x 12"W x 18"D, Right Hand | | | | | | |
| 65"H x 12"W x 18"D, Left Hand | HSWF651218LM | 108 | 11.0 | \$1280 | \$1357 | \$1425 |
| 50"H x 12"W x 18"D, Right Hand | HSWF501218RM | 87 | 8.4 | \$1195 | \$1272 | \$1340 |
| 50"H x 12"W x 18"D, Left Hand | HSWF501218LM | 87 | 8.4 | \$1195 | \$1272 | \$1340 |
| 42"H x 12"W x 18"D, Right Hand | HSWF421218RM | 77 | 7.1 | \$1019 | \$1069 | \$1144 |
| 42"H x 12"W x 18"D, Left Hand | HSWF421218LM | 77 | 7.1 | \$1019 | \$1069 | \$1144 |

NOTES: Wardrobes come installed with a rod accessory to accept clothing hangars or a Fuse™ work tool coat hook can be added (sold separately). Wardrobes have slots cut into the inner liner that allow the user to hang Fuse™ work tool accessories inside the unit. 42"H wardrobes have 2 slots; 50"H and 65"H wardrobes have 4 slots. Wardrobes ship with one adjustable shelf. 42"H and 50"H wardrobes have 3 shelf locations; 65"H wardrobes have 6 shelf locations.

NOTES:

- 1 18"D Wardrobes: 42"H and 50"H plinth wardrobes can be freestanding. 18"D footed units must be attached to a panel, worksurface, or ganged to another unit.
- 1 24"D Wardrobes: 42"H and 50"H plinth and footed wardrobes can be freestanding.
- 1 65"H Wardrobes: 18"D and 24"D must be attached to a panel, worksurface, or ganged to another unit.

HOW TO SPECIFY

| | | | | | |
|--|---|--|---|---|---|
| <p>Select Model Number</p> <p>H S W F 6 5 1 2 2 4 R M .</p> | <p>Select Base/Foot</p> <p>BK Flush Plinth Base BX Recessed Plinth Base SF Contain Foot T1 Platinum Metallic PR6 Silver</p> <p>S F T 1 .</p> | <p>Select Pull</p> <p>A Arch PRO Silver R Radius N Integral S Square PR6 Silver</p> <p>S P R 6 .</p> | <p>Select Paint Color</p> <p>See page 666</p> <p>P J W .</p> | <p>Select Front Paint</p> <p>See page 666 NA Matches Case (+ \$0) P1 upcharge (+ \$150) P2 upcharge (+ \$170) P3 upcharge (+ \$190)</p> <p>N A .</p> | <p>Select Lock</p> <p>L Standard Lock X Omit Lock (- \$20)</p> <p>L</p> |
|--|---|--|---|---|---|



Icon Legend on page 19

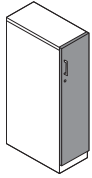

| DESCRIPTION | MODEL | SHIP WEIGHT | CUBE | LIST PRICE BY PAINT GRADE | | |
|---|---------------------|-------------|------|---------------------------|--------|--------|
| | | | | P1 | P2 | P3 |
| Wardrobe Tower, Plinth w/Laminate Fronts | | | | | | |
| 65”H x 12”W x 24”D, Right Hand | HSWP651224RL | 108 | 14.8 | \$1436 | \$1513 | \$1581 |
| 65”H x 12”W x 24”D, Left Hand | HSWP651224LL | 108 | 14.8 | \$1436 | \$1513 | \$1581 |
| 50”H x 12”W x 24”D, Right Hand | HSWP501224RL | 87 | 11.5 | \$1329 | \$1406 | \$1474 |
| 50”H x 12”W x 24”D, Left Hand | HSWP501224LL | 87 | 11.5 | \$1329 | \$1406 | \$1474 |
| 42”H x 12”W x 24”D, Right Hand | HSWP421224RL | 77 | 9.9 | \$1109 | \$1159 | \$1234 |
| 42”H x 12”W x 24”D, Left Hand | HSWP421224LL | 77 | 9.9 | \$1109 | \$1159 | \$1234 |
| Wardrobe Tower, Footed w/Laminate Fronts | | | | | | |
| 65”H x 12”W x 18”D, Right Hand | HSWF651218RL | 108 | 11.6 | \$1317 | \$1394 | \$1462 |
| 65”H x 12”W x 18”D, Left Hand | HSWF651218LL | 108 | 11.6 | \$1317 | \$1394 | \$1462 |
| 50”H x 12”W x 18”D, Right Hand | HSWF501218RL | 87 | 9.0 | \$1219 | \$1296 | \$1364 |
| 50”H x 12”W x 18”D, Left Hand | HSWF501218LL | 87 | 9.0 | \$1219 | \$1296 | \$1364 |
| 42”H x 12”W x 18”D, Right Hand | HSWF421218RL | 77 | 7.7 | \$1017 | \$1067 | \$1142 |
| 42”H x 12”W x 18”D, Left Hand | HSWF421218LL | 77 | 7.7 | \$1017 | \$1067 | \$1142 |

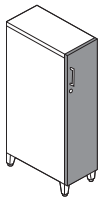

| | | | | | | |
|---|---------------------|-----|------|--------|--------|--------|
| Wardrobe Tower, Footed w/Laminate Fronts | | | | | | |
| 65”H x 12”W x 24”D, Right Hand | HSWF651224RL | 108 | 14.1 | \$1570 | \$1647 | \$1715 |
| 65”H x 12”W x 24”D, Left Hand | HSWF651224LL | 108 | 14.1 | \$1570 | \$1647 | \$1715 |
| 50”H x 12”W x 24”D, Right Hand | HSWF501224RL | 87 | 10.8 | \$1464 | \$1541 | \$1609 |
| 50”H x 12”W x 24”D, Left Hand | HSWF501224LL | 87 | 10.8 | \$1464 | \$1541 | \$1609 |
| 42”H x 12”W x 24”D, Right Hand | HSWF421224RL | 77 | 9.1 | \$1243 | \$1293 | \$1368 |
| 42”H x 12”W x 24”D, Left Hand | HSWF421224LL | 77 | 9.1 | \$1243 | \$1293 | \$1368 |
| Wardrobe Tower, Footed w/Laminate Fronts | | | | | | |
| 65”H x 12”W x 18”D, Right Hand | HSWF651218RL | 108 | 11.0 | \$1452 | \$1529 | \$1597 |
| 65”H x 12”W x 18”D, Left Hand | HSWF651218LL | 108 | 11.0 | \$1452 | \$1529 | \$1597 |
| 50”H x 12”W x 18”D, Right Hand | HSWF501218RL | 87 | 8.4 | \$1354 | \$1431 | \$1499 |
| 50”H x 12”W x 18”D, Left Hand | HSWF501218LL | 87 | 8.4 | \$1354 | \$1431 | \$1499 |
| 42”H x 12”W x 18”D, Right Hand | HSWF421218RL | 77 | 7.1 | \$1151 | \$1201 | \$1276 |
| 42”H x 12”W x 18”D, Left Hand | HSWF421218LL | 77 | 7.1 | \$1151 | \$1201 | \$1276 |

NOTES: Wardrobes come installed with a rod accessory to accept clothing hangars or a Fuse™ work tool coat hook can be added (sold separately). Wardrobes have slots cut into the inner liner that allow the user to hang Fuse™ work tool accessories inside the unit. 42”H wardrobes have 2 slots; 50”H and 65”H wardrobes have 4 slots. Wardrobes ship with one adjustable shelf. 42”H and 50”H wardrobes have 3 shelf locations; 65”H wardrobes have 6 shelf locations.

NOTES:

- 1 18”D Wardrobes: 42”H and 50”H plinth wardrobes can be freestanding. 18”D footed units must be attached to a panel, worksurface, or ganged to another unit.
- 1 24”D Wardrobes: 42”H and 50”H plinth and footed wardrobes can be freestanding.
- 1 65”H Wardrobes: 18”D and 24”D must be attached to a panel, worksurface, or ganged to another unit.

HOW TO SPECIFY

| | | | | | |
|--|---|---|---|---|---|
| <p>Select Model Number</p> <p>BX Recessed Plinth Base SF Contain Foot T1 Platinum Metallic PR6 Silver</p> | <p>Select Base/Foot</p> <p>A Arch PRO Silver S Square PR6 Silver</p> | <p>Select Pull</p> <p>See page 666</p> | <p>Select Case Paint</p> <p>See page 666</p> | <p>Select Laminate</p> <p>See page 666</p> | <p>Select Lock</p> <p>L Standard Lock X Omit Lock (- \$20)</p> |
| H S W F 6 5 1 2 2 4 R L . | S F T 1 . | S P R 6 . | P J W . | L S A 1 . | L |

STORAGE

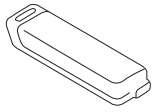

DESCRIPTION

MODEL

SHIP WEIGHT

CUBE

LIST PRICE

Digital Keys

Digilock Programming Key
Digilock Manager Key

HSLDIGPRG
HSLDIGMGR

0.8
0.8

0.0
0.0

\$181
\$141

NOTES: A Programming Key is used to initialize locks out of factory default mode and register Manager Keys to the locks. Manager Keys are used to bypass a locked unit, operating as the “master key” and it is recommended that building facilitators have at least one Manager Key. Up to 6 Manager Keys may be registered to each lock. Manager Keys provide external power to locks in case of battery failure. Programming Key is the same key as Fuse™ Digilocks and can work across both Contain® and Fuse™.

- ⓘ Only one Programming Key should be specified per installation and multiple Programming Keys are not compatible with each other.
- ⓘ Add-on digital lock orders should be programmed with the original Programming Key.

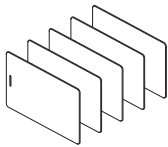

RFID Cards

Digilock RFID Cards, Pack of 5
Digilock RFID Cards, Pack of 25
Digilock RFID Cards, Pack of 100

HSLRFID5C
HSLRFID25C
HSLRFID100C

0.3
0.5
1.9

0.0
0.0
0.0

\$119
\$562
\$2130

NOTES: RFID cards are plain white and have a lanyard cutout.

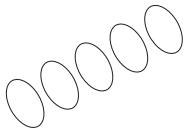

RFID Stickers

Digilock RFID Stickers, Pack of 5
Digilock RFID Stickers, Pack of 25
Digilock RFID Stickers, Pack of 100

HSLRFID5S
HSLRFID25S
HSLRFID100S

0.3
0.5
1.9

0.0
0.0
0.0

\$63
\$282
\$1066

NOTES: RFID stickers are plain white, approximately 1” in diameter and may be added to the back of an existing employee badge or identification card.

STORAGE

HOW TO SPECIFY

Select
Model Number

H S L R F I D 2 5 C



Icon Legend on page 19

CONTAIN[®] Metal Pedestals

| | DESCRIPTION | MODEL | SHIP WEIGHT | CUBE | LIST PRICE BY PAINT GRADE | | |
|--|--|----------------------------|-------------|------|---------------------------|--------------|--------------|
| | | | | | P1 | P2 | P3 |
| | Hanging Pedestal with Metal Fronts, Box/File | | | | | | |
| | 18"H x 15"W x 18"D | HSPH181518BFM(?) | 35.8 | 4.4 | \$627 | \$655 | \$683 |
| | 18"H x 15"W x 24"D | HSPH181524BFM(?) | 39.3 | 5.7 | \$668 | \$696 | \$724 |
| | 18"H x 15"W x 30"D | HSPH181530BFM(?) | 45.6 | 6.4 | \$706 | \$734 | \$762 |
| | Mobile Pedestal with Metal Fronts, Box/File | | | | | | |
| | 21"H x 15"W x 18"D | HSPM211518BFM(?) | 63.5 | 4.4 | \$627 | \$655 | \$683 |
| | 21"H x 15"W x 24"D | HSPM211524BFM(?) | 61.9 | 5.7 | \$673 | \$701 | \$729 |
| | Mobile Pedestal with Metal Fronts, Box/Box/File | | | | | | |
| | 27"H x 15"W x 18"D | HSPM271518BBFM(?) | 63.4 | 5.3 | \$812 | \$840 | \$868 |
| | 27"H x 15"W x 24"D | HSPM271524BBFM(?) | 71.9 | 6.6 | \$857 | \$885 | \$913 |
| | 27"H x 15"W x 30"D | HSPM271530BBFM(?) | 83.6 | 8.2 | \$901 | \$929 | \$957 |
| | Mobile Pedestal with Metal Fronts, File/File | | | | | | |
| | 27"H x 15"W x 18"D | HSPM271518FFM(?) | 60.9 | 5.3 | \$812 | \$840 | \$868 |
| | 27"H x 15"W x 24"D | HSPM271524FFM(?) | 65.7 | 6.6 | \$857 | \$885 | \$913 |
| | 27"H x 15"W x 30"D | HSPM271530FFM(?) | 75.2 | 8.2 | \$901 | \$929 | \$957 |
| | Plinth Support Pedestal with Metal Fronts, Box/Box/File | | | | | | |
| | 28"H x 15"W x 18"D | HSPSBX281518BBFM(?) | 50.4 | 5.9 | \$785 | \$813 | \$841 |
| | 28"H x 15"W x 24"D | HSPSBX281524BBFM(?) | 58.6 | 7.5 | \$828 | \$856 | \$884 |
| | 28"H x 15"W x 30"D | HSPSBX281530BBFM(?) | 69.8 | 9.3 | \$873 | \$901 | \$929 |
| | Plinth Support Pedestal with Metal Fronts, File/File | | | | | | |
| | 28"H x 15"W x 18"D | HSPSBX281518FFM(?) | 45.1 | 5.9 | \$785 | \$813 | \$841 |
| | 28"H x 15"W x 24"D | HSPSBX281524FFM(?) | 52.1 | 7.5 | \$828 | \$856 | \$884 |
| | 28"H x 15"W x 30"D | HSPSBX281530FFM(?) | 61.1 | 9.3 | \$873 | \$901 | \$929 |

STORAGE

NOTES:

- Ball-bearing suspension on box and file drawer. (100%)
- Drawers color to be interior gray steel.
- See page 701 for Pedestal Seat.
- File drawer has high sides and back for filing front to back and side to side.
- Counterweight standard on all mobile peds.
- Pencil tray standard in top box drawer.
- One box divider standard in each box drawer.

- One crossrail standard in each file drawer.
- 24"D and 30"D pedestals accommodate legal files side to side.
- ! A-Pull available in Satin Chrome only.
- ! Locking units equipped with HON "One Key" interchangeable core removable locks. Keyed alike core model HF23S, in Satin, must be ordered separately. See page 675.
- ! **NEW MODELS LAUNCHING Q4 2021. SEE DIGITAL PRICER FOR UPDATES.**

HOW TO SPECIFY

| | | |
|---|---|--|
| <p>Select Model Number</p> <p>Replace (?) with handle choice</p> <p>A Satin Chrome Arch N Full Face Integral R Full Radius</p> <p>H S P H 1 8 1 5 1 8 B F M A .</p> | <p>Select Paint Color</p> <p>See page 666</p> <p>P .</p> | <p>Select Lock Option</p> <p>L Standard Lock X Omit Lock (deduct \$20)</p> <p>L</p> |
|---|---|--|

CONTAIN[®] Footed Metal Pedestals

GSA SIN 33721

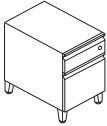
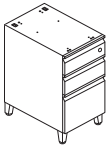
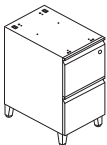

Icon Legend on page 19

| | DESCRIPTION | MODEL | SHIP WEIGHT | CUBE | LIST PRICE BY PAINT GRADE | | |
|--|---|--|----------------------|-------------------|---|---|--|
| | | | | | P1 | P2 | P3 |
|  | Footed Freestanding Pedestal with Metal Fronts, Box/File | | | | | | |
| | 22"H x 15"W x 18"D 22"H x 15"W x 24"D | HSPFSF221518BFM(?) HSPFSF221524BFM(?) | 66.8 73.1 | 4.4 5.7 | \$737 \$779 | \$765 \$807 | \$793 \$835 |
|  | Footed Support Pedestal with Metal Fronts, Box/Box/File | | | | | | |
| | 28"H x 15"W x 18"D 28"H x 15"W x 24"D 28"H x 15"W x 30"D | HSPSSF281518BBFM(?) HSPSSF281524BBFM(?) HSPSSF281530BBFM(?) | 49.8 57.4 68.3 | 5.3 6.6 8.2 | \$922 \$963 \$1010 | \$950 \$991 \$1038 | \$978 \$1019 \$1066 |
| | Footed Support Pedestal with Metal Fronts, File/File | | | | | | |
|  | 28"H x 15"W x 18"D 28"H x 15"W x 24"D 28"H x 15"W x 30"D | HSPSSF281518FFM(?) HSPSSF281524FFM(?) HSPSSF281530FFM(?) | 47.3 54.3 60.0 | 5.3 6.6 8.2 | \$922 \$963 \$1010 | \$950 \$991 \$1038 | \$978 \$1019 \$1066 |
| | Flush Pedestal Kickplates (Field Installable) | HSPAK15 | 2.0 | 0.2 | \$122 | \$130 | \$135 |
| | Specify: Model.Paint SPECIFYING EXAMPLE: HSPAK.P | | | | | | |

STORAGE

NOTES:

- Ball-bearing suspension on box and file drawer. (100%)
- Drawers color to be interior gray steel.
- File drawer has high sides and back for filing front-to-back and side-to-side.
- Counterweight standard on all mobile peds.
- See page 701 for Pedestal Seat.
- Pencil tray standard in top box drawer.
- One box divider standard in each box drawer.
- One crossrail standard in each file drawer.
- 24"D and 30"D pedestals accommodate legal files side-to-side.
- ! A-Pull available in Satin Chrome only.
- ! Locking units equipped with HON "One Key" interchangeable core removable locks. Keyed alike core model HF23S, in Satin, must be ordered separately. See page 675.
- ! **NEW MODELS LAUNCHING Q4 2021. SEE DIGITAL PRICER FOR UPDATES.**

HOW TO SPECIFY



| | | | |
|---|---|---|--|
| Select Model Number Replace (?) with handle choice A Satin Chrome Arch N Full Face Integral R Full Radius | Select Paint Color See page 666 | Select Lock Option L Standard Lock X Omit Lock (deduct \$20) | Select Foot Color T1 Platinum Metallic PR6 Silver |
| H S P F S F 2 2 1 5 1 8 B F M A . | P . | L . | T 1 |



Icon Legend on page 19

CONTAIN[®] Footed Metal Pedestals

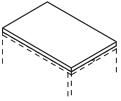
| | DESCRIPTION | MODEL | SHIP WEIGHT | CUBE | LIST PRICE |
|-----------|--|-------|-------------|------|------------|
| SIN 33721 | Counterweight — Freestanding Support Pedestals or Systems Support and Mobile Pedestals | HPCW1 | 18 | 0.1 | \$223 |

| | DESCRIPTION | MODEL | SHIP WEIGHT | CUBE | FABRIC PRICE CODES | | | |
|---|--|------------|--|------|--------------------|-------|----|-------|
|  OPEN MARKET  | Pedestal Seat 15"W x 22 ⁷ / ₈ "D x 2"H NOTES: For seating fabrics, see pages 22-24. SPECIFYING EXAMPLE: HPSEAT24ND.APN23 | HPSEAT24ND | 10  | 1.2 | 1 | \$222 | 8 | \$418 |
| | | | | | 2 | \$246 | 9 | \$449 |
| | | | | | 3 | \$270 | 10 | \$480 |
| | | | | | 4 | \$294 | 11 | \$511 |
| | | | | | 5 | \$325 | 12 | \$542 |
| | | | | | 6 | \$356 | L | — |
| | | | | | 7 | \$387 | | |

STORAGE

HOW TO SPECIFY

| | |
|---|---|
| Select Model Number HPSEAT24. | Select Fabric See pages 22-24 for seating fabric options APN23 |
|---|---|

CONTAIN[®] Metal Pedestals with Laminate Fronts

GSA SIN 33721



Icon Legend on page 19

| | DESCRIPTION | MODEL | SHIP WEIGHT | CUBE | LIST PRICE BY PAINT GRADE | | |
|--|---|----------------------------|-------------|------|---------------------------|---------------|---------------|
| | | | | | P1 | P2 | P3 |
| | Hanging Pedestal with Laminate Fronts, Box/File | | | | | | |
| | 18"H x 15"W x 18"D, Arch Pull | HSPH181518BFL(?) | 37.6 | 4.4 | \$802 | \$830 | \$858 |
| | 18"H x 15"W x 24"D, Arch Pull | HSPH181524BFL(?) | 43.9 | 5.7 | \$842 | \$870 | \$898 |
| | 18"H x 15"W x 30"D, Arch Pull | HSPH181530BFL(?) | 53.0 | 6.4 | \$880 | \$908 | \$936 |
| | Mobile Pedestal with Laminate Fronts, Box/File | | | | | | |
| | 21"H x 15"W x 18"D, Arch Pull | HSPM211518BFL(?) | 65.3 | 4.4 | \$802 | \$830 | \$858 |
| | 21"H x 15"W x 24"D, Arch Pull | HSPM211524BFL(?) | 63.7 | 5.7 | \$847 | \$875 | \$903 |
| | Mobile Pedestal with Laminate Fronts, Box/Box/File | | | | | | |
| | 27"H x 15"W x 18"D, Arch Pull | HSPM271518BBFL(?) | 65.0 | 5.3 | \$1041 | \$1069 | \$1097 |
| | 27"H x 15"W x 24"D, Arch Pull | HSPM271524BBFL(?) | 73.5 | 6.6 | \$1085 | \$1113 | \$1141 |
| | 27"H x 15"W x 30"D, Arch Pull | HSPM271530BBFL(?) | 85.2 | 8.2 | \$1130 | \$1158 | \$1186 |
| | Mobile Pedestal with Laminate Fronts, File/File | | | | | | |
| | 27"H x 15"W x 18"D, Arch Pull | HSPM271518FFL(?) | 63.4 | 5.3 | \$1041 | \$1069 | \$1097 |
| | 27"H x 15"W x 24"D, Arch Pull | HSPM271524FFL(?) | 68.1 | 6.6 | \$1085 | \$1113 | \$1141 |
| | 27"H x 15"W x 30"D, Arch Pull | HSPM271530FFL(?) | 77.6 | 8.2 | \$1130 | \$1158 | \$1186 |
| | Plinth Support Pedestal with Laminate Fronts, Box/Box/File | | | | | | |
| | 28"H x 15"W x 18"D, Arch Pull | HSPSBX281518BBFL(?) | 51.7 | 5.9 | \$1015 | \$1043 | \$1071 |
| | 28"H x 15"W x 24"D, Arch Pull | HSPSBX281524BBFL(?) | 59.9 | 7.5 | \$1056 | \$1084 | \$1112 |
| | 28"H x 15"W x 30"D, Arch Pull | HSPSBX281530BBFL(?) | 71.1 | 9.3 | \$1103 | \$1131 | \$1159 |
| | Plinth Support Pedestal with Laminate Fronts, File/File | | | | | | |
| | 28"H x 15"W x 18"D, Arch Pull | HSPSBX281518FFL(?) | 47.6 | 5.9 | \$1015 | \$1043 | \$1071 |
| | 28"H x 15"W x 24"D, Arch Pull | HSPSBX281524FFL(?) | 54.6 | 7.5 | \$1056 | \$1084 | \$1112 |
| | 28"H x 15"W x 30"D, Arch Pull | HSPSBX281530FFL(?) | 63.6 | 9.3 | \$1103 | \$1131 | \$1159 |

STORAGE

NOTES:

- Ball-bearing suspension on box and file drawer. (100%)
- Drawers color to be interior gray steel.
- File drawer has high sides and back for filing front-to-back and side-to-side.
- Counterweight standard on all mobile peds.
- See page 701 for Pedestal Seat.
- Pencil tray standard in top box drawer.
- One box divider standard in each box drawer.
- One crossrail standard in each file drawer.
- 24"D and 30"D pedestals accommodate legal files side-to-side.
- ! Drawer Fronts available with Satin Chrome Arch only.
- ! Locking units equipped with HON "One Key" interchangeable core removable locks. Keyed alike core model HF23S, in Satin, must be ordered separately. See page 675.
- ! **NEW MODELS LAUNCHING Q4 2021. SEE DIGITAL PRICER FOR UPDATES.**

HOW TO SPECIFY

| | | | |
|---|--|---|--|
| <p>Select Model Number</p> <p>Replace (?) with handle choice</p> <p>A Satin Chrome Arch</p> <p>H S P H 1 8 1 5 1 8 B F L A .</p> | <p>Select Paint Color</p> <p>See page 666</p> <p>P .</p> | <p>Select Lock Option</p> <p>L Standard Lock X Omit Lock (deduct \$20)</p> <p>L .</p> | <p>Select Laminate Option</p> <p>See page 666</p> <p>C</p> |
|---|--|---|--|



Icon Legend on page 19

Footed Metal Pedestals with Laminate Fronts

| | DESCRIPTION | MODEL | SHIP WEIGHT | CUBE | LIST PRICE BY PAINT GRADE | | |
|--|--|----------------------------|-------------|------|---------------------------|---------------|---------------|
| | | | | | P1 | P2 | P3 |
| | Footed Freestanding Pedestal with Laminate Fronts, Box/File | | | | | | |
| | 22”H x 15”W x 18”D, Arch Pull | HSPFSF221518BFL(?) | 69.0 | 4.4 | \$912 | \$940 | \$968 |
| | 22”H x 15”W x 24”D, Arch Pull | HSPFSF221524BFL(?) | 75.3 | 5.7 | \$953 | \$981 | \$1009 |
| | Footed Support Pedestal with Laminate Fronts, Box/Box/File | | | | | | |
| | 28”H x 15”W x 18”D, Arch Pull | HSPSSF281518BBFL(?) | 51.4 | 5.3 | \$1148 | \$1176 | \$1204 |
| | 28”H x 15”W x 24”D, Arch Pull | HSPSSF281524BBFL(?) | 59.0 | 6.6 | \$1193 | \$1221 | \$1249 |
| | 28”H x 15”W x 30”D, Arch Pull | HSPSSF281530BBFL(?) | 69.9 | 8.2 | \$1236 | \$1264 | \$1292 |
| | Footed Support Pedestal with Laminate Fronts, File/File | | | | | | |
| | 28”H x 15”W x 18”D, Arch Pull | HSPSSF281518FFL(?) | 49.7 | 5.3 | \$1148 | \$1176 | \$1204 |
| | 28”H x 15”W x 24”D, Arch Pull | HSPSSF281524FFL(?) | 56.7 | 6.6 | \$1193 | \$1221 | \$1249 |
| | 28”H x 15”W x 30”D, Arch Pull | HSPSSF281530FFL(?) | 62.4 | 8.2 | \$1236 | \$1264 | \$1292 |

NOTES:

- Ball-bearing suspension on box and file drawer. (100%)
- Drawers color to be interior gray steel.
- File drawer has high sides and back for filing front-to-back and side-to-side.
- Counterweight standard on all mobile peds.
- See page 701 for Pedestal Seat.
- Pencil tray standard in top box drawer.
- One box divider standard in each box drawer.
- One crossrail standard in each file drawer.
- 24”D and 30”D pedestals accommodate legal files side-to-side.

! Drawer Fronts available with Satin Chrome Arch only.

! Locking units equipped with HON “One Key” interchangeable core removable locks. Keyed alike core model HF23S, in Satin, must be ordered separately. See page 675.

! NEW MODELS LAUNCHING Q4 2021. SEE DIGITAL PRICER FOR UPDATES.

STORAGE

HOW TO SPECIFY

| | | | | |
|--|---|--|---|---|
| <p>Select Model Number</p> <p>Replace (?) with handle choice</p> <p>A Satin Chrome Arch</p> <p>H S P F S F 2 2 1 5 1 8 B F L A .</p> | <p>Select Paint Color</p> <p>See page 666</p> <p>P .</p> | <p>Select Lock Option</p> <p>L Standard Lock X Omit Lock (deduct \$20)</p> <p>L .</p> | <p>Select Laminate Option</p> <p>See page 666</p> <p>C .</p> | <p>Select Foot Color</p> <p>T1 Platinum Metallic PR6 Silver</p> <p>T 1</p> |
|--|---|--|---|---|

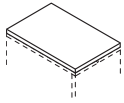

DESCRIPTION

Pedestal Seat

15"W x 22⁷/₈"D x 2"H

NOTES: For seating fabrics, see pages 22-24.

SPECIFYING EXAMPLE: HPSEAT24ND.APN23

MODEL

HPSEAT24ND

SHIP WEIGHT

10

CUBE

1.2

FABRIC PRICE CODES

| | | | |
|---|-------|----|-------|
| 1 | \$222 | 8 | \$418 |
| 2 | \$246 | 9 | \$449 |
| 3 | \$270 | 10 | \$480 |
| 4 | \$294 | 11 | \$511 |
| 5 | \$325 | 12 | \$542 |
| 6 | \$356 | L | — |
| 7 | \$387 | | |

NOTES:

- See Brigade[®] pedestals on page 656 for additional pedestal options. See pages 750-751 for Pedestal Accessories.

STORAGE

HOW TO SPECIFY

| | |
|---|--|
| <p>Select Model Number</p> <p>HPSEAT24 .</p> | <p>Select Fabric</p> <p>See pages 22-24 for seating fabric options</p> <p>APN23</p> |
|---|--|



Flagship® Modular Storage.

STORAGE

FLAGSHIP®

Pedestals in more than 40 styles. Lateral files in 15 sizes. These are just some of the reasons why Flagship is one of HON's top metal storage collections, and why HON is America's filing and storage leader. Today's offices run on information, and Flagship helps them sort, store and share every bit of it — plus all of the personal items and daily supplies employees depend on. It's the best-built storage available from any manufacturer at any price.



FEATURES

- Rugged, high-quality construction makes HON America's leader in filing and storage.
- ColorCorrect® lets you match your Flagship storage to many office furniture manufacturers.
- Add seat cushions to mobile pedestals for short-term, stow-away guest seating.
- Modular Storage with bins for easy access and customization.
- Lateral files with storage cabinets not only corral all your info, they double as collaborative hubs.
- Squeeze more storage capacity into a smaller workstation footprint by using pedestals as worksurface supports.
- Archival filing doesn't have to be stuffy. Outfit any open space with a wall full of storage, available at a moment's notice.

FLAGSHIP® ORDERING INFORMATION

FLAGSHIP® PRODUCTS

PAINTS CODES

- P1**
- ◆ Black **P**
 - ◆ Brownstone **P7D**
 - ◆ Charcoal **S**
 - ◆ Designer White **PJW**
 - ◆ Fossil **P28**
 - ◆ Greige **T5**
 - ◆ Light Gray **Q**
 - ◆ Loft **LOFT**
 - ◆ Muslin **T3**
 - ◆ Putty **L**
 - ◆ Shadow * **SHDW**
 - ◆ Titanium **P8T**

- P2**
- ◆ Champagne Metallic **T4**
 - ◆ Platinum Metallic **T1**

OPTIONAL LAMINATE TOPS FOR LATERAL FILES

L1 LAMINATES CODES

- Woodgrain**
- ◆ Bourbon Cherry **H**
 - ◆ Cognac **COGN**
 - ◆ Florence Walnut **LFW1**
 - ◆ Harvest **C**
 - ◆ Kingswood Walnut **LK11**
 - ◆ Mahogany **N**
 - ◆ Mocha **MOCH**
 - ◆ Natural Maple **D**
 - ◆ Pinnacle **PINC**
 - ◆ Shaker Cherry **F**
 - ◆ Sterling Ash **LSA1**

- Solid**
- ◆ Charcoal **S**
 - ◆ Designer White **LDW1**
 - ◆ Loft **LOFT**

- Patterned**
- ◆ Handspun Chestnut **LAHC**
 - ◆ Handspun Dove **LAHD**
 - ◆ Handspun Pearl **LAHP**
 - ◆ Handspun Slate **LAHS**
 - ◆ Sheer Mesh* **A5**
 - ◆ Silver Mesh* **B9**
 - ◆ Steel Mesh* **A9**
 - ◆ Canyon Zephyr * **K9**
 - ◆ Desert Zephyr * **K8**
 - ◆ Shadow Zephyr * **K1**
 - ◆ Gray* **G2**
 - ◆ White* **G1**

L2 LAMINATES CODES

- Woodgrain**
- ◆ Lowell Ash **LLA1**
 - ◆ Natural Recon **LNRI**
 - ◆ Phantom Ecreu **LPE1**
 - ◆ Portico Teak **LPT1**
 - ◆ Skyline Walnut **LSW1**

PULL OPTIONS FOR CONTAIN® AND FLAGSHIP® STORAGE

Suffix "A"



Satin Chrome
Arch Pull

Suffix "N"



Full Face Integral
Drawer Pull

Suffix "R"



Full Radius
Drawer Pull

NOTES: Arch pulls available in Satin Chrome only.

* Laminate colors will have the following pre-set edgeband colors:

| Laminate | Edge |
|-------------|----------|
| Sheer Mesh | Muslin |
| Silver Mesh | Loft |
| Steel Mesh | Charcoal |
| Gray | Charcoal |
| White | Charcoal |

Edgeband matches top except as noted.

For Champagne Metallic Paint, Muslin is the suggested edgeband color. When Champagne Metallic Paint is selected, pulls are standard in Muslin.





◆◆◆ For lead time information see page 19.

* De-emphasized

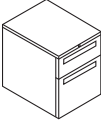

Icon Legend on page 19

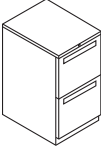
Hanging and Standard Height Pedestals

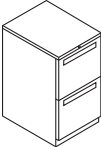
| | DESCRIPTION | MODEL | SHIP WEIGHT | CUBE | LIST PRICE BY PAINT GRADE | | |
|---|--|------------------|-------------|------|---------------------------|--------------|--------------|
| | | | | | P1 | P2 | P3 |
|  | Hanging Pedestals — Box/File | | | | | | |
| | 15"W x 16 ⁷ / ₈ "D x 19 ¹ / ₂ "H | H14917(?) | 41 | 4.4 | \$617 | \$645 | \$673 |
| | 15"W x 22 ⁷ / ₈ "D x 19 ¹ / ₂ "H | H14923(?) | 48 | 6.0 | \$657 | \$685 | \$713 |
|  | Standard Height Mobile Pedestals — Box/Box/File | | | | | | |
| | 15"W x 16 ⁷ / ₈ "D x 28"H | H18717(?) | 76 | 5.9 | \$790 | \$818 | \$846 |
| | 15"W x 22 ⁷ / ₈ "D x 28"H | H18723(?) | 88 | 8.0 | \$851 | \$879 | \$907 |
| | 15"W x 28 ⁷ / ₈ "D x 28"H | H18730(?) | 102 | 9.8 | \$913 | \$941 | \$969 |
|  | Standard Height Mobile Pedestals — File/File | | | | | | |
| | 15"W x 16 ⁷ / ₈ "D x 28"H | H18817(?) | 72 | 5.9 | \$790 | \$818 | \$846 |
| | 15"W x 22 ⁷ / ₈ "D x 28"H | H18823(?) | 85 | 8.0 | \$851 | \$879 | \$907 |
| | 15"W x 28 ⁷ / ₈ "D x 28"H | H18830(?) | 98 | 9.8 | \$913 | \$941 | \$969 |
|  | Standard Height Freestanding Support Pedestals — Box/Box/File | | | | | | |
| | 15"W x 16 ⁷ / ₈ "D x 28"H | H19717(?) | 59 | 5.9 | \$779 | \$807 | \$835 |
| | 15"W x 22 ⁷ / ₈ "D x 28"H | H19723(?) | 73 | 8.0 | \$837 | \$865 | \$893 |
| | 15"W x 28 ⁷ / ₈ "D x 28"H | H19730(?) | 87 | 9.8 | \$900 | \$928 | \$956 |
|  | Standard Height Freestanding Support Pedestals — File/File | | | | | | |
| | 15"W x 16 ⁷ / ₈ "D x 28"H | H19817(?) | 55 | 5.9 | \$779 | \$807 | \$835 |
| | 15"W x 22 ⁷ / ₈ "D x 28"H | H19823(?) | 70 | 8.0 | \$837 | \$865 | \$893 |
| | 15"W x 28 ⁷ / ₈ "D x 28"H | H19830(?) | 83 | 9.8 | \$900 | \$928 | \$956 |

STORAGE

NOTES:

- 28"H fits under all HON worksurfaces and desk shells.
- 22⁷/₈"D and 28⁷/₈"D pedestals accommodate legal files side-to-side.
- Pencil tray standard in top box drawer.
- One box divider standard in each box drawer.
- One crossrail standard in each file drawer.
- Steel ball-bearing suspension on file and box drawers.
- Full extension on all drawers.
- File drawers have high sides for filing front-to-back.
- See pages 750-751 for accessories and pedestal utilization information.
- Equipped with HON "One Key" interchangeable core removable locks.
- Hanging units are mounted using keyhole slots in top of pedestals; all hardware provided.
- Arch pull available in Satin Chrome only.
- Available in Arch (A), Full Face Integral (N) and Full Radius (R) Drawer Pulls. See page 706 for pull options.
- Choose from any of three pull options with no upcharge.
- Counterweight standard in mobile pedestals.
- Omit lock-option available. See page 773 for ordering instructions.
- See Brigade® pedestals on page 656 for additional pedestal options. See pages 750-751 for Pedestal Accessories.

! Freestanding support pedestals that are not positioned and attached under a worksurface require a counterweight kit found on page 750.

HOW TO SPECIFY

| | | |
|---|--|---|
| Select Model Number A Satin Chrome Arch N Full Face Integral R Full Radius | Select Lock Option L Lock (no upcharge) X Omit Lock (deduct \$20) | Select Paint Color See page 706 |
| H 1 4 9 1 7 A | L | P |

FLAGSHIP® Mobile Pedestals

GSA SIN AS NOTED



Icon Legend on page 19



HI5923N

SIN 33721

DESCRIPTION

Mobile Pedestals — Box/File
15"W x 22⁷/₈"D x 22"H

| MODEL | SHIP WEIGHT | CUBE | LIST PRICE BY PAINT GRADE | | |
|-----------|-------------|------|---------------------------|-------|-------|
| | | | P1 | P2 | P3 |
| HI5923(?) | 92 | 6.0 | \$663 | \$691 | \$719 |

NOTES:

- Pencil tray standard in top box drawer.
- One box divider standard in each box drawer.
- One crossrail standard in each file drawer.
- File drawers have high sides for filing front-to-back.
- Steel ball-bearing suspension on file drawer, and box drawer.
- See pages 750-751 for accessories and pedestal utilization information.
- Arch pull available in Satin Chrome only.
- Choose from any of three pull options with no upcharge.
- Available in Arch (A), Full Face Integral (N) and Full Radius (R) Drawer Pulls. See page 706 for pull options.
- Equipped with HON "One Key" interchangeable core removable locks.
- Counterweight standard.
- Omit lock-option available. See page 773 for ordering instructions.

STORAGE

HOW TO SPECIFY

| | | |
|---|---|--|
| Select Model Number A Satin Chrome Arch N Full Face Integral R Full Radius H 1 5 9 2 3 A | Select Lock Option L Lock (no upcharge) X Omit Lock (deduct \$20) X | Select Paint Color See page 706 T 1 |
|---|---|--|

DESCRIPTION

Pedestal Seat
15"W x 22⁷/₈"D x 2"H

NOTES: For seating fabrics, see pages 22-24.

| MODEL | SHIP WEIGHT | CUBE | FABRIC PRICE CODES | | | |
|------------|-------------|------|--------------------|-------|----|-------|
| HPSEAT24ND | 10 Ⓞ | 1.2 | 1 | \$222 | 8 | \$418 |
| | | | 2 | \$246 | 9 | \$449 |
| | | | 3 | \$270 | 10 | \$480 |
| | | | 4 | \$294 | 11 | \$511 |
| | | | 5 | \$325 | 12 | \$542 |
| | | | 6 | \$356 | L | — |
| | | | 7 | \$387 | | |

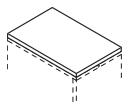

OPEN MARKET

NOTES:

- See Brigade® pedestals on page 656 for additional pedestal options. See pages 750-751 for Pedestal Accessories.

HOW TO SPECIFY

| | |
|---|---|
| Select Model Number H P S E A T 2 4 | Select Fabric See pages 22-24 for seating fabric options A P N 2 3 |
|---|---|



Icon Legend on page 19

18" Deep Lateral Files with Drawers

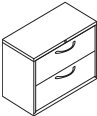
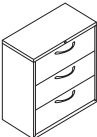
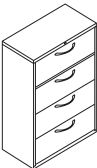
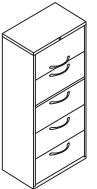
| | DESCRIPTION | MODEL | SHIP WEIGHT | CUBE | LIST PRICE BY PAINT GRADE | | |
|--|--|-----------------|-------------|------|---------------------------|---------------|---------------|
| | | | | | P1 | P2 | P3 |
|  <p>Standard Height</p> | Standard Height Lateral File — 2 Drawer | | | | | | |
| | 30"W x 18"D x 28"H | H9170(?) | 138 | 12.3 | \$1116 | \$1149 | \$1183 |
| | 36"W x 18"D x 28"H | H9180(?) | 156 | 14.5 | \$1233 | \$1266 | \$1300 |
| | 42"W x 18"D x 28"H | H9190(?) | 177 | 16.8 | \$1426 | \$1459 | \$1493 |
|  | Lateral File — 3 Drawer | | | | | | |
| | 30"W x 18"D x 39 ¹ / ₈ "H | H9173(?) | 150 | 16.9 | \$1461 | \$1494 | \$1528 |
| | 36"W x 18"D x 39 ¹ / ₈ "H | H9183(?) | 174 | 20.0 | \$1640 | \$1673 | \$1707 |
| | 42"W x 18"D x 39 ¹ / ₈ "H | H9193(?) | 197 | 23.2 | \$1898 | \$1931 | \$1965 |
|  | Lateral File w/o Posting Shelf — 4 Drawer | | | | | | |
| | 30"W x 18"D x 52 ¹ / ₂ "H | H9174(?) | 176 | 22.1 | \$1841 | \$1908 | \$1974 |
| | 36"W x 18"D x 52 ¹ / ₂ "H | H9184(?) | 198 | 26.2 | \$2090 | \$2157 | \$2223 |
| | 42"W x 18"D x 52 ¹ / ₂ "H | H9194(?) | 213 | 30.3 | \$2397 | \$2464 | \$2530 |
|  | Lateral File w/o Posting Shelf — 5 Drawer | | | | | | |
| | 30"W x 18"D x 64 ¹ / ₄ "H | H9175(?) | 203 | 26.8 | \$2351 | \$2418 | \$2484 |
| | 36"W x 18"D x 64 ¹ / ₄ "H | H9185(?) | 238 | 31.8 | \$2647 | \$2714 | \$2780 |
| | 42"W x 18"D x 64 ¹ / ₄ "H | H9195(?) | 264 | 36.8 | \$3068 | \$3135 | \$3201 |
| | NOTES: Top drawer is a roll-out shelf. | | | | | | |

STORAGE

NOTES:

- 28"H lateral fit under standard 38000 Series and worksurfaces.
- Flush top and sides.
- Reinforced case construction.
- Lock mechanism serves both sides of drawer.
- Equipped with HON "One Key" interchangeable core removable locks.
- Counterweight included where applicable to meet ANSI/BIFMA stability requirements.
- Three-part, telescoping, steel ball-bearing suspension.
- Features drawer extension restraint; mechanical interlock inhibits the extension of more than one drawer at a time.
- Optional laminate tops and accessories — see page 747.
- Matching Pedestals — see page 707.
- Omit lock-option available. See page 773 for ordering instructions.
- Arch pull available in Satin Chrome only.
- Choose from any of three pull options with no upcharge.
- Available in Arch (A), Full Face Integral (N) and Full Radius (R) Drawer Pulls. See below and page 706 for pull options.
- See page 747 for Lateral File Accessories.
- Flagship® laterals can be used with Storage Islands, see page 733.

HOW TO SPECIFY

Select Model Number

Select the Pull

- A** Satin Chrome Arch
- N** Full Face Integral
- R** Full Radius

H 9 1 7 0 A .

Select Lock Option

- L** Lock (no upcharge)
- X** Omit Lock (deduct \$20)

L .

Select Paint Color

See page 706

P

FLAGSHIP® Lateral File with Storage

GSA SIN 33721



Icon Legend on page 19

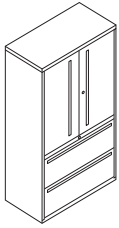

Model H9185LSN shown

DESCRIPTION

Lateral Files with Storage and Hinged Doors
36"W x 18"D x 64¼"H

NOTES: Lateral File drawers lock independently from storage case.

MODEL

H9185LS(?)

SHIP WEIGHT

203

CUBE

31.8

LIST PRICE BY PAINT GRADE

P1

\$2537

P2

\$2604

P3

\$2670

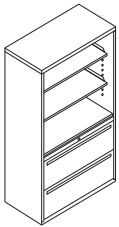

Model H9185LSNN shown

DESCRIPTION

Lateral Files with Open Shelves, No Doors
36"W x 18"D x 64¼"H

H9185LSN(?)

184

31.8

\$2314

\$2381

\$2447

STORAGE

NOTES:

- 64¼"H models complement Flagship lateral file heights.
- Equipped with HON "One Key" interchangeable core removable locks. Locks on storage cabinet doors and lateral file are keyed alike.
- Three-part, telescoping, steel ball-bearing suspension.
- Includes two adjustable shelves, adjustable in 2" increments.
- Lock mechanism serves both sides of drawer.
- Features drawer extension restraint; mechanical interlock inhibits the extension of more than one drawer at a time.
- Wire management grommet in back of unit.
- Omit lock-option available. See page 773 for ordering instructions.
- Flush top and sides.
- Choose from any of three pull options with no upcharge.
- Arch pull available in Satin Chrome only.
- Available in Arch (A), Full Face Integral (N) and Full Radius (R) Drawer Pulls. See page 706 for pull options.

HOW TO SPECIFY

Select Model Number

Select the Pull

- A** Satin Chrome Arch
- N** Full Face Integral
- R** Full Radius

H 9 1 8 5 L S A .

Select Lock Option

- L** Lock (no upcharge)
- X** Omit Lock (deduct \$40 for models H91756LS and H9185LS) (deduct \$20 for models H9175LSN and H9185LSN)

X .

Select Paint Color

See page 706

P



Icon Legend on page 19

FLAGSHIP® Modular Storage

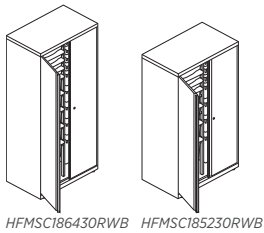

HFMSC186430RWB HFMSC185230RWB

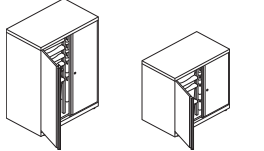

HFMSC183930RWB HFMSC182830RWB

DESCRIPTION

Modular Storage Cabinet
 18"D x 28"H x 30"W
 18"D x 39 1/8"H x 30"W
 18"D x 52 1/2"H x 30"W
 18"D x 64 1/4"H x 30"W

| MODEL | SHIP WEIGHT | CUBE | LIST PRICE BY PAINT GRADE | | |
|----------------|-------------|------|---------------------------|--------|--------|
| | | | P1 | P2 | P3 |
| HFMSC182830RWB | 119 | 12.0 | \$1179 | \$1212 | \$1246 |
| HFMSC183930RWB | 138 | 16.2 | \$1429 | \$1462 | \$1496 |
| HFMSC185230RWB | 176 | 22.4 | \$1725 | \$1792 | \$1858 |
| HFMSC186430RWB | 184 | 28.2 | \$2011 | \$2078 | \$2144 |

NOTES:

- Shipped fully assembled.
- Pre-configured trays and rails are included, see chart below.
- Additional Tray Kits may be purchased separately.
- Full radius handle on both doors.
- Four adjustable leveling glides standard.
- Reinforced top and base.
- Equipped with HON "One Key" interchangeable core removable locks standard.
- Doors have vertical stiffener standard.
- Positive door stops.
- Meets or exceeds ANSI/BIFMA and ISTA standards.
- Certified SCS Indoor Advantage Gold.

STORAGE

Pre-Configured Cabinets/Tray Kits

| 64" High Cabinet | | 52" High Cabinet | | 39" High Cabinet | | 28" High Cabinet | |
|------------------|---|------------------|---|------------------|---|------------------|---|
| 1 | 2 | 1 | 2 | 1 | 2 | 1 | 2 |
| 3 | 4 | 3 | 4 | 3 | 4 | 3 | 4 |
| 5 | 6 | 5 | 6 | 5 | 6 | 5 | 6 |
| 7 | 8 | 7 | 8 | 7 | 8 | 7 | 8 |
| 1 | 2 | 1 | 2 | 1 | 2 | 1 | 2 |
| 3 | 4 | 3 | 4 | 3 | 4 | 3 | 4 |
| 5 | 6 | 5 | 6 | 5 | 6 | 5 | 6 |
| 7 | 8 | 7 | 8 | 7 | 8 | 7 | 8 |
| 1 | 2 | 1 | 2 | 1 | 2 | 1 | 2 |

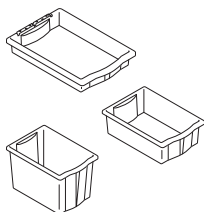

DESCRIPTION

Accessories — Tray Kit
 3"H, 2 bins and 4 rails
 6"H, 2 bins and 4 rails
 12"H, 2 bins and 4 rails

| MODEL | SHIP WEIGHT | CUBE | LIST PRICE |
|----------|-------------|------|------------|
| HFMBIN3 | 7 Ⓞ | 4.0 | \$59 |
| HFMBIN6 | 10 Ⓞ | 4.5 | \$72 |
| HFMBIN12 | 12 Ⓞ | 5.0 | \$84 |

NOTES: Modular Storage Cabinets come with rails and bins. Additional bins and rails may be ordered in sets of 2. Availability and usage are outlined below.

NOTES:

- Tray height options include: 3", 6", 12".
- Trays may only be used in 12" width single column/section only.
- All trays are suspended off a pair of storage rails, trays slide easily in and out and are removable.
- Trays and storage rails are field installed and may be easily reconfigured.
- Front and rear handles are integrated for easy handling/transport.
- Translucent material provides visibility to contents.

HOW TO SPECIFY

| | | | |
|--|--|--|---|
| <p>Select Model Number</p> <p>H F M S C 1 8 6 4 3 0 R W B .</p> | <p>Select Lock Option</p> <p>L Lock (no upcharge) X Omit Lock (deduct \$20) See page 773 for omit lock ordering instructions</p> <p>L .</p> | <p>Select Glide</p> <p>G Glide</p> <p>G .</p> | <p>Select Paint Color</p> <p>See page 706</p> <p>L D W 1</p> |
|--|--|--|---|

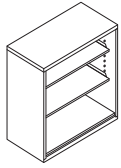

DESCRIPTION

3 Shelf
36"W x 18"D x 39½"H

| MODEL | SHIP WEIGHT | CUBE | LIST PRICE BY PAINT GRADE | | |
|--------------------|-------------|------|---------------------------|---------------|---------------|
| | | | P1 | P2 | P3 |
| HFSC183640W | 100 | 20.0 | \$976 | \$1043 | \$1109 |

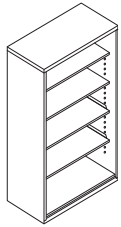

5 Shelf
36"W x 18"D x 64¼"H

NOTES: 64¼"H models complement Flagship lateral file heights.

| | | | | | |
|--------------------|-----|------|---------------|---------------|---------------|
| HFSC183664W | 148 | 31.8 | \$1445 | \$1512 | \$1578 |
|--------------------|-----|------|---------------|---------------|---------------|

STORAGE

NOTES:

- Flush top and sides.
- Reinforced case construction.
- Shelves adjust in 2" increments.
- Wire management grommet in back of unit.

HOW TO SPECIFY

Select Model Number

Select Paint Color

See page 706

H F S C 1 8 3 6 4 0 W .

P



Icon Legend on page 19

FLAGSHIP® Storage Cabinets

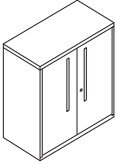
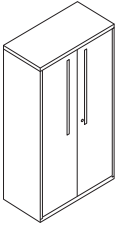
| | DESCRIPTION | MODEL | SHIP WEIGHT | CUBE | LIST PRICE BY PAINT GRADE | | |
|--|---|----------------------|-------------|------|---------------------------|---------------|---------------|
| | | | | | P1 | P2 | P3 |
|  <p>Model HFSC183640N shown</p> | <p>Storage Cabinets 36"W x 18"D x 39 7/8"H (with lock) 2 adjustable shelves</p> | HFSC183640(?) | 119 | 20.0 | \$1209 | \$1276 | \$1342 |
|  <p>Model HFSC183664N shown</p> | <p>36"W x 18"D x 64 1/4"H (with lock) 4 adjustable shelves NOTES: 64 1/4"H models complement Flagship lateral file heights.</p> | HFSC183664(?) | 184 | 31.8 | \$1761 | \$1828 | \$1894 |

NOTES:

- Flush top and sides.
- Reinforced case construction.
- Includes adjustable shelves, adjustable in 2" increments.
- Arch pull available in Satin Chrome only.
- Choose from any of three pull options with no upcharge.
- Available in Arch (A), Full Face Integral (N) and Full Radius (R) Drawer Pulls. See below and page 706 for pull options.
- Four adjustable leveling glides are standard.
- Equipped with HON "One Key" interchangeable core removable locks.
- Wire management grommet in back of unit.
- Omit lock-option available. See page 773 for ordering instructions.

STORAGE

HOW TO SPECIFY

| | | |
|--|--|--|
| <p>Select Model Number</p> <p>Select the Pull</p> <p>A Satin Chrome Arch N Full Face Integral R Full Radius</p> <p>H F S C 1 8 3 6 4 0 A</p> | <p>Select Lock Option</p> <p>L Lock (no upcharge) X Omit Lock (deduct \$20)</p> <p>L</p> | <p>Select Paint Color</p> <p>See page 706</p> <p>P</p> |
|--|--|--|

FLAMESAFE™ ORDERING INFORMATION

FLAMESAFE™ PRODUCTS

PAINTS CODES

P1

◆ Black P

◆ Light Gray Q

◆ Putty L

STORAGE

◆◆◆ For lead time information see page 19.



FLAMESAFE™ Fire-Resistant Files

| | DESCRIPTION | MODEL | SHIP WEIGHT | CUBE | LIST PRICE |
|--|---|-------------|-------------|------|---------------|
| | Vertical File — 2-Drawer, Letter 17¾"W x 25"D x 27¾"H | H52 | 320 | 10.0 | \$4010 |
| | Vertical File — 2-Drawer, Legal 20¾"W x 25"D x 27¾"H | H52C | 341 | 13.0 | \$4112 |
| | Vertical File — 4-Drawer, Letter 17¾"W x 25"D x 52¾"H | H54 | 546 | 17.0 | \$6173 |
| | Vertical File — 4-Drawer, Legal 20¾"W x 25"D x 52¾"H | H54C | 596 | 21.0 | \$6302 |

NOTES:

- Full suspension.
- Non-asbestos.
- Follower block comes standard.
- Chrome drawer pulls, thumb latch and label holder.
- Rated: Filing Device Class 350, 1700° for one hour with drop test.
- UL listed.
- High drawer sides.
- Available in Putty, Black and Gray only; see page 714.
- Insulated in drawer face and between drawers.
- **Full Lifetime Warranty.**

! Lock is NOT core removable.

HOW TO SPECIFY

| | | |
|--|---|---|
| <p>Select Model Number</p> <p>H 5 2 .</p> | <p>Select Lock Option</p> <p>P Lock</p> <p>P .</p> | <p>Select Paint Color</p> <p>See page 714</p> <p>P</p> |
|--|---|---|

| | DESCRIPTION | MODEL | SHIP WEIGHT | CUBE | LIST PRICE |
|--|---|------------|-------------|------|---------------|
| | Lateral File — 2-Drawer 31⅞"W x 22⅞"D x 27¾"H | H32 | 436 | 11.0 | \$5905 |
| | Lateral File — 4-Drawer 31⅞"W x 22⅞"D x 52¾"H NOTES: Lateral Drawer inside dimensions: 25⅜"W x 15⅞"D x 10⅜"H | H34 | 723 | 26.0 | \$8911 |

NOTES:

- Telescoping suspension.
- Non-asbestos.
- Available in Putty, Black and Gray only; see page 714.
- Rated: Filing Device Class 350, 1700° for one hour with drop test.
- Insulated in drawer face and between drawers.
- UL listed.
- 4 hangrails per opening, standard.
- Black, plastic recessed drawer pulls.
- **Full Lifetime Warranty.**

! Lock is NOT core removable.

HOW TO SPECIFY

| | | |
|--|---|---|
| <p>Select Model Number</p> <p>H 3 2 .</p> | <p>Select Lock Option</p> <p>P Lock</p> <p>P .</p> | <p>Select Paint Color</p> <p>P Black Q Light Gray L Putty</p> <p>P</p> |
|--|---|---|

STORAGE



Fuse™ Mobile Pedestal shown with Solve® Seating and Empower®.

FUSE™

Who says storage has to be boring? With a completely modern take on form and function, not to mention an ultra-cool color palette, Fuse storage adds personality to any home office or corporate workspace. With personal storage space for just about everything, Fuse keeps you organized even in small spaces.



FEATURES

- Designed to make the most of the compressed footprint of desking, benching and height-adjustable workstations.
- Extra thick, low profile case provides increased strength and durability while providing a modern 360-degree aesthetic for your storage needs.
- Extended height drawers give you the extra capacity to neatly store what matters most to you.
- Add a pop of color with an optional two-tone design to give new meaning to personal space.
- Alcove for stowing backpack, purse, bag, or other personal items.
- Rear casters swivel and front casters are fixed for easier mobility.
- Casters are designed to clear the top of Coordinate™ feet.
- File drawer has high sides to allow front-to-back filing for 15" wide models.
- Side-to-side filing uses file bars for support for 10" wide models.
- Standard core removable locks make rekeying a breeze.
- Electronic keypad lock option allows for ease of locking and unlocking personal items with your Fuse™ unit.

FUSE™ ORDERING INFORMATION

FUSE™ PRODUCTS

| PAINTS | CODES |
|----------------------|-------|
| P1 | |
| ◆ Black | P |
| ◆ Brownstone | P7D |
| ◆ Designer White | PJW |
| ◆ Charcoal | P02 |
| ◆ Fossil*** | P28 |
| ◆ Greige | T5 |
| ◆ Loft | LOFT |
| ◆ Muslin | T3 |
| ◆ Titanium | P8T |
| P2* | |
| ◆ Champagne Metallic | T4 |
| ◆ Silver | PR6 |
| ◆ Solar Black | P8X |
| P3** | |
| ◆ Amethyst | P091 |
| ◆ Atom | P8S |
| ◆ Blossom*** | P8K |
| ◆ Bullseye | PJF |
| ◆ Cabernet*** * | P7T |
| ◆ Cobalt Mica | P090 |
| ◆ Conifer*** * | P8H |
| ◆ Ember | P8P |
| ◆ Ion | P8N |
| ◆ Iris | P8J |
| ◆ Krypton | P8F |
| ◆ Ochre | P093 |
| ◆ Regatta | P8M |
| ◆ Sienna | P092 |
| ◆ Succulent*** | P8A |

PULLS

| | |
|-----------------|------|
| ◆ Square Silver | SPR6 |
| ◆ Linear Silver | LPR6 |
| ◆ Linear Black | LP |

WORKPLACE TOOLS

| | |
|------------------|----|
| ◆ Designer White | DW |
|------------------|----|

PULL OPTIONS FOR FUSE™ STORAGE



Square

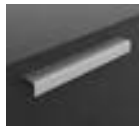

Linear

*P2 upcharges \$18 for each dot option selected.

**P3 upcharges \$40 for each dot option selected.

***TREND COLORS: These colors are intended to be an inspirational option for the trending market. Product application is limited and color availability is approximately two years to coincide with evolving workplace trends.

- The HON Company has elected to discontinue the HON Choice paint program, as of 12/31/2018, and roll it into our standard specials process.
- A special request will need to be submitted to receive pricing and order information.

◆◆◆ For lead time information see page 19.

* De-emphasized

FUSE™ Pedestals

Fuse Pedestal Functionality with Workplace Tools

STORAGE

Large & Slim Trays

- Ships in 9" and/or 15" bin drawers where applicable
- Organizes notepads, rulers, pens, pencils, paper clips, sticky notes, etc
- Radiused compartments allow for easy pick up of those small items
- Versatile tray can be utilized on top of your pedestal, drawers, or on the worksurface

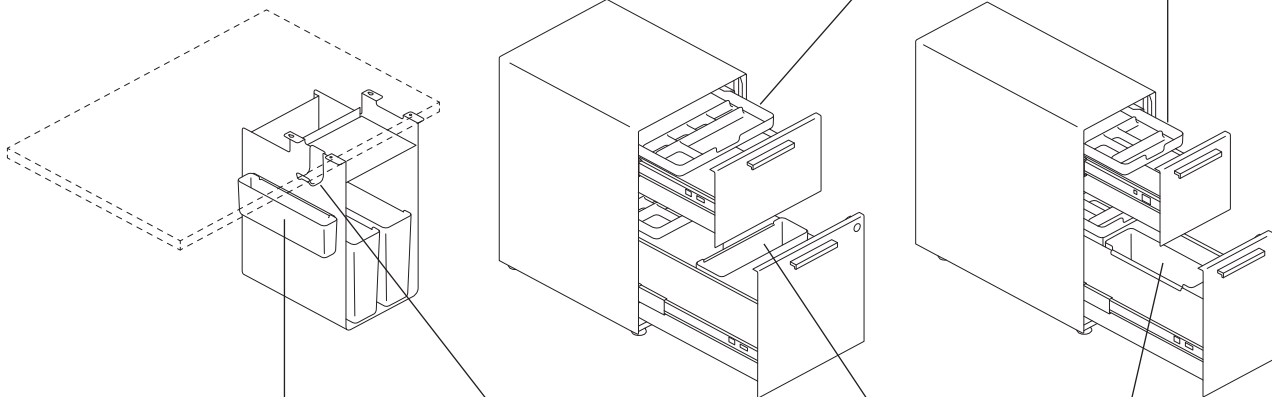

Side Saddle

- Stores small personal items such as your phone, tablet, and other organizational items
- Hangs on the drawer side, sits on the drawer bottom, undermount side slot and case top.
- Division in the bottom creates two storage areas
- Also hangs on the paper management support bars on page 465

Hook

- Used to hang backpacks, coats, headphones, umbrellas, and other personal items
- Can be used only in the undermount side slot or case top lip
- Thoughtfully designed to stay in place
- Supports up to 20 pounds

Hot File

- Take multiple project folders with you to your next meeting
- Ridges in the bottom keep files upright
- Hangs on the drawer side, undermount or sit in the drawer bottom to subdivide space
- Makes files accessible without having to even open a drawer
- Also hangs on the paper management support bars on page 465

Configuration Options - Fuse

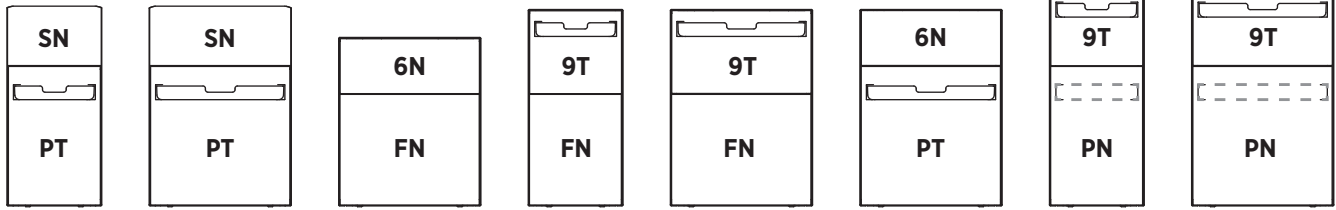

Legend

- 6N = 6" Box No Tray
- 9T = 9" Box Bin with Tray
- SN = Alcove
- FN = 12" File No Tray
- PN = 15" File No Tray
- PT = 15" Bin with Tray

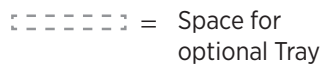
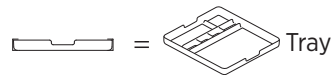

FUSE™ DIGITAL LOCK SPECIFICATIONS

Digital Keypad Lock Specification Information for Fuse™ Pedestals

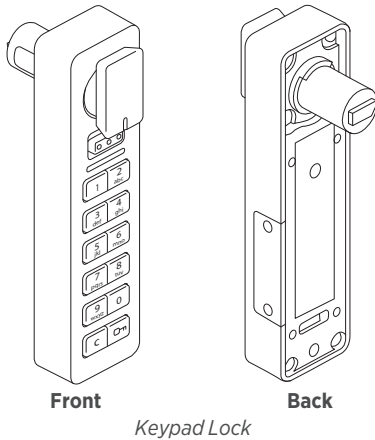

Keypad Lock

The digital keypad lock option helps modernize the workspace by eliminating the need to carry physical keys. The digital lock feature provides an alternative to standard lock and key, allowing users to simply input a code to unlock their Fuse™ storage unit. The digital keypad also supports shared applications where workstations or storage units support multiple users. These locks ship in “shared mode” by default; shared mode indicates that the lock will “forget” the paired 4-digit code after the lock is opened, allowing the unit to be used by multiple users.

❗ Order at least one Programming Key and Manager Key per install.

Digital Keypad Locks:

- Offered on all Fuse™ pedestal and undermount models.
- Ship factory installed.
- Offered in a brushed nickel finish.
- Digital keypad lock requires input of a user-selected 4-digit code.
- Digital keypad locks are powered using 2 premium lithium CR2032 batteries.
- Battery life is dependent on the frequency of operation but can last up to 5-7 years.
- **Every digital keypad installation site will require one Programming Key and at least one Manager Key, sold separately.**

Programming Key

- A Programming Key is a device used to initialize locks out of factory default mode and register Manager Keys to the locks.
- Only one Programming Key should be specified per installation site because multiple Programming Keys are not compatible with each other.
- Add-on digital lock orders should be programmed with the original Programming Key.
- Programming Key is the same key as Contain® Digilocks and can work across both Contain® and Fuse™.

Manager Key

- A Manager Key is used to bypass a locked unit; this operates as the “master key” and it is recommended that building facilitators have at least one Manager Key.
- Up to 6 Manager Keys may be registered to each lock.
- Manager Keys provide external power to locks in case of battery failure.

| Digital Lock Keys and Accessories | | |
|-----------------------------------|-----------|------------|
| Description | Model | List Price |
| Programming Key | HSLDIGPRG | \$160 |
| Manager Key | HSLDIGMGR | \$125 |

FUSE™ Mobile Pedestals

OPEN MARKET



Icon Legend on page 19

STORAGE

| | DESCRIPTION | MODEL | SHIP WEIGHT | CUBE | LIST PRICE |
|--|---|---------------------|-------------|------|--------------|
| | Mobile Pedestal, 6" Box/12" File 15"W x 19"D x 20 3/8"H 15"W x 23"D x 20 3/8"H | HAPMAP196NFN | 48 | 5.0 | \$668 |
| | | HAPMAP236NFN | 54 | 5.9 | \$717 |
| | NOTES: No tray, Specification of tray color not required. | | | | |
| | Mobile Pedestal, 9" Bin with Tray/12" File 15"W x 19"D x 23 3/8"H 15"W x 23"D x 23 3/8"H | HAPMBP199TFN | 53 | 5.7 | \$753 |
| | | HAPMBP239TFN | 58 | 6.7 | \$806 |
| | Mobile Pedestal, 6" Box/15" Bin with Tray 15"W x 19"D x 23 3/8"H 15"W x 23"D x 23 3/8"H | HAPMBP196NPT | 53 | 5.7 | \$753 |
| | | HAPMBP236NPT | 58 | 6.7 | \$806 |
| | Mobile Pedestal, 9" Bin with Tray/15" Bin 15"W x 19"D x 26 3/8"H 15"W x 23"D x 26 3/8"H | HAPMCP199TPN | 58 | 6.4 | \$811 |
| | | HAPMCP239TPN | 62 | 7.5 | \$862 |
| | Mobile Pedestal, Alcove/15" File with Tray 15"W x 19"D x 21 1/2"H | HAPMBP195NPT | 58 | 5.7 | \$701 |
| | NOTES: Top matches drawer color. | | | | |
| | Slim Mobile Pedestal, 9" Bin with Tray/12" File 10"W x 23"D x 23 3/8"H | HAPMBS239TFN | 47 | 4.9 | \$767 |
| | | | | | |
| | Slim Mobile Pedestal, 9" Bin with Tray/15" Bin 10"W x 23"D x 26 3/8"H | HAPMCS239TPN | 52 | 5.4 | \$825 |
| | | | | | |
| | Slim Mobile Pedestal, Alcove/15" Bin with Tray 10"W x 23"D x 21 1/2"H | HAPMBS235NPT | 43 | 4.9 | \$714 |
| | NOTES: Top matches drawer color. | | | | |

HOW TO SPECIFY

| | | | | | |
|----------------------------|--|--|--|--------------------------|--|
| Select Model Number | Select Pull Option | Select Case Color | Select Drawer Color | Select Tray Color | Select Lock Option |
| | SPR6 Square Silver LPR6 Linear Silver LP Linear Black | See page 717 P2 upcharge (+ \$18) P3 upcharge (+ \$40) | See page 717 P2 upcharge (+ \$18) P3 upcharge (+ \$40) | DW Designer White | L Standard Lock X Omit Lock (deduct \$20) |
| H A P M A P 1 9 6 N F N . | S P R 6 . | P . | S . | D W . | L . |



Icon Legend on page 19

Mobile Pedestals with eLock

| | DESCRIPTION | MODEL | SHIP WEIGHT | CUBE | LIST PRICE |
|--|---|----------------------|-------------|------|---------------|
| | Mobile Pedestal, 6" Box/12" File, eLock 15"W x 19"D x 20 3/8"H 15"W x 23"D x 20 3/8"H NOTES: No tray, Specification of tray color not required. | HAPMAP196NFNE | 48 | 5.0 | \$909 |
| | | HAPMAP236NFNE | 54 | 5.9 | \$956 |
| | Mobile Pedestal, 9" Box/12" File, eLock 15"W x 19"D x 23 3/8"H 15"W x 23"D x 23 3/8"H | HAPMBP199TFNE | 53 | 5.7 | \$991 |
| | | HAPMBP239TFNE | 58 | 6.7 | \$1039 |
| | Mobile Pedestal, 6" Box/15" File, eLock 15"W x 19"D x 23 3/8"H 15"W x 23"D x 23 3/8"H | HAPMBP196NPTE | 53 | 5.7 | \$991 |
| | | HAPMBP236NPTE | 58 | 6.7 | \$1039 |
| | Mobile Pedestal, 9" Box/15" File, eLock 15"W x 19"D x 26 3/8"H 15"W x 23"D x 26 3/8"H | HAPMCP199TPNE | 58 | 6.4 | \$1045 |
| | | HAPMCP239TPNE | 62 | 7.5 | \$1094 |
| | Mobile Pedestal, Alcove/15" File, eLock 15"W x 19"D x 21 1/2"H NOTES: Top matches drawer color. | HAPMBP19SNPTE | 45 | 5.7 | \$940 |
| | Slim Mobile Pedestal, 9" Box/12" File, eLock 10"W x 23"D x 23 3/8"H | HAPMBS239TFNE | 47 | 4.9 | \$1002 |
| | Slim Mobile Pedestal, 9" Box/15" File, eLock 10"W x 23"D x 26 3/8"H | HAPMCS239TPNE | 52 | 5.4 | \$1058 |
| | Slim Mobile Pedestal, Alcove/15" File, eLock 10"W x 23"D x 21 1/2"H NOTES: Top matches drawer color. | HAPMBS23SNPTE | 43 | 4.9 | \$952 |

STORAGE

NOTES:

ⓘ Every installation will require one Programming Key and at least one Manager Key.

HOW TO SPECIFY

| Select Model Number | Select Pull Option | Select Case Color | Select Drawer Color | Select Tray Color | Select Lock Option |
|---|--|--|--|-------------------|---------------------------------|
| SPR6 Square Silver LPR6 Linear Silver LP Linear Black | See page 717 P2 upcharge (+ \$18) P3 upcharge (+ \$40) | See page 717 P2 upcharge (+ \$18) P3 upcharge (+ \$40) | See page 717 P2 upcharge (+ \$18) P3 upcharge (+ \$40) | DW Designer White | EBNL eLock Brushed Nickel |
| H A P M A P 1 9 6 N F N E . | S P R 6 . | P . | S . | D W . | E B N L |

FUSE™ Freestanding Pedestals

OPEN MARKET



Icon Legend on page 19

STORAGE

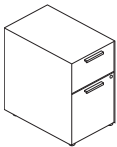
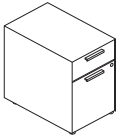
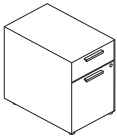
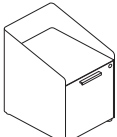
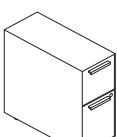
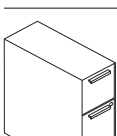
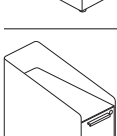
| | DESCRIPTION | MODEL | SHIP WEIGHT | CUBE | LIST PRICE |
|--|---|---------------------|-------------|------|--------------|
|  | Freestanding Pedestal, 9" Bin with Tray/12" File 15"W x 19"D x 21"H | HAPGBP199TFN | 53 | 5.7 | \$732 |
| | 15"W x 23"D x 21"H | HAPGBP239TFN | 58 | 5.7 | \$782 |
|  | Freestanding Pedestal, 6" Box/15" Bin with Tray 15"W x 19"D x 21"H | HAPGBP196NPT | 53 | 5.7 | \$732 |
| | 15"W x 23"D x 21"H | HAPGBP236NPT | 58 | 5.7 | \$782 |
|  | Freestanding Pedestal, 9" Bin with Tray/15" Bin 15"W x 19"D x 24"H | HAPGCP199TPN | 58 | 5.7 | \$787 |
| | 15"W x 23"D x 24"H | HAPGCP239TPN | 62 | 5.7 | \$838 |
|  | Freestanding Pedestal, Alcove/15" Bin with Tray 15"W x 19"D x 21"H NOTES: Top matches drawer color. | HAPGBP19SNPT | 45 | 5.7 | \$681 |
|  | Slim Freestanding Pedestal, 9" Bin with Tray/12" File 10"W x 23"D x 21"H | HAPGBS239TFN | 47 | 5.7 | \$745 |
| | | | | | |
|  | Slim Freestanding Pedestal, 9" Bin with Tray/15" Bin 10"W x 23"D x 24"H | HAPGCS239TPN | 52 | 5.4 | \$800 |
| | | | | | |
|  | Slim Freestanding Pedestal, Alcove/15" Bin with Tray 10"W x 23"D x 21"H NOTES: Top matches drawer color. | HAPGBS23SNPT | 43 | 4.9 | \$694 |
| | | | | | |

HOW TO SPECIFY

| | | | | | |
|----------------------------|--|--|--|--------------------------|--|
| Select Model Number | Select Pull Option | Select Case Color | Select Drawer Color | Select Tray Color | Select Lock Option |
| | SPR6 Square Silver LPR6 Linear Silver LP Linear Black | See page 717 P2 upcharge (+ \$18) P3 upcharge (+ \$40) | See page 717 P2 upcharge (+ \$18) P3 upcharge (+ \$40) | DW Designer White | L Standard Lock X Omit Lock (deduct \$20) |
| H A P G B P 1 9 9 T F N . | S P R 6 . | P . | S . | D W . | L . |



Icon Legend on page 19

Freestanding Pedestals with eLock

| | DESCRIPTION | MODEL | SHIP WEIGHT | CUBE | LIST PRICE |
|--|--|----------------------|-------------|------|---------------|
| | Freestanding Pedestal, 9" Box/12" File, eLock 15"W x 19"D x 21"H | HAPGBP199TFNE | 53 | 5.7 | \$969 |
| | 15"W x 23"D x 21"H | HAPGBP239TFNE | 58 | 6.7 | \$1017 |
| | Freestanding Pedestal, 6" Box/15" File, eLock 15"W x 19"D x 21"H | HAPGBP196NPTE | 53 | 5.7 | \$969 |
| | 15"W x 23"D x 21"H | HAPGBP236NPTE | 58 | 6.7 | \$1017 |
| | Freestanding Pedestal, 9" Box/15" File, eLock 15"W x 19"D x 24"H | HAPGCP199TPNE | 58 | 6.4 | \$1022 |
| | 15"W x 23"D x 24"H | HAPGCP239TPNE | 62 | 7.5 | \$1071 |
| | Freestanding Pedestal, Alcove/15" File, eLock 15"W x 19"D x 21"H NOTES: Top matches drawer color. | HAPGBP195NPTE | 45 | 5.7 | \$920 |
| | Slim Freestanding Pedestal, 9" Box/12" File, eLock 10"W x 23"D x 24"H | HAPGBS239TFNE | 47 | 4.9 | \$981 |
| | | | | | |
| | Slim Freestanding Pedestal, 9" Box/15" File, eLock 10"W x 23"D x 24"H | HAPGCS239TPNE | 52 | 5.4 | \$1034 |
| | | | | | |
| | Slim Freestanding Pedestal, Alcove/15" File 10"W x 23"D x 24"H NOTES: Top matches drawer color. | HAPGBS235NPTE | 43 | 4.9 | \$932 |
| | | | | | |

STORAGE

NOTES:

! Every installation will require one Programming Key and at least one Manager Key.

HOW TO SPECIFY

| | | | | | |
|--|--|--|--|---|--|
| <p>Select Model Number</p> <p>H A P G B P 1 9 9 T F N E .</p> | <p>Select Pull Option</p> <p>SPR6 Square Silver LPR6 Linear Silver LP Linear Black</p> <p>S P R 6 .</p> | <p>Select Case Color</p> <p>See page 717 P2 upcharge (+ \$18) P3 upcharge (+ \$40)</p> <p>P .</p> | <p>Select Drawer Color</p> <p>See page 717 P2 upcharge (+ \$18) P3 upcharge (+ \$40)</p> <p>S .</p> | <p>Select Tray Color</p> <p>DW Designer White</p> <p>D W .</p> | <p>Select Lock Option</p> <p>EBNL eLock Brushed Nickel</p> <p>E B N L</p> |
|--|--|--|--|---|--|

FUSE™ Pedestal Cushion

OPEN MARKET



Icon Legend on page 19

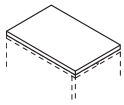

DESCRIPTION

Seat Cushion
For 19"D Pedestal

MODEL

HAESC19

SHIP WEIGHT

6

CUBE

1.0

FABRIC PRICE CODES

| | | | |
|---|-------|----|-------|
| 1 | \$208 | 8 | \$346 |
| 2 | \$232 | 9 | \$364 |
| 3 | \$256 | 10 | \$382 |
| 4 | \$274 | 11 | \$400 |
| 5 | \$292 | 12 | \$418 |
| 6 | \$310 | L | — |
| 7 | \$328 | | |

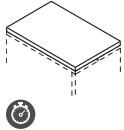

Seat Cushion
For 23"D Pedestal

HPSEAT24ND

10

1.2

| | | | |
|---|-------|----|-------|
| 1 | \$222 | 8 | \$418 |
| 2 | \$246 | 9 | \$449 |
| 3 | \$270 | 10 | \$480 |
| 4 | \$294 | 11 | \$511 |
| 5 | \$325 | 12 | \$542 |
| 6 | \$356 | L | — |
| 7 | \$387 | | |

STORAGE

HOW TO SPECIFY

Select Model Number

Select Fabric

See pages 22-24 for seating fabric options





H A E S C 1 9 .

C U 1 0

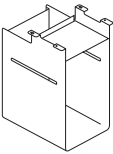
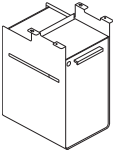

Icon Legend on page 19

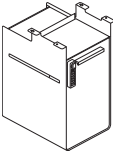
Undermount Storage

| | DESCRIPTION | MODEL | SHIP WEIGHT | CUBE | LIST PRICE |
|---|--|--|-------------|------------|------------------------------|
|  | Undermount Storage Cubby NOTES: No need to specify door color or lock option. | HAUFO15N | 19 | 3.3 | \$403 |
|  | Undermount Storage Cubby with Locking Door Right-Hinged Left-Hinged NOTES: Right-Hinged shown. | HAUFHR15N  HAUFHL15N | 24 24 | 3.3 3.3 | \$477 \$477 |
|  | Undermount Storage Cubby with Locking Door, eLock Right-Hinged Left-Hinged  Every installation will require one Programming Key and at least one Manager Key. | HAUFHR15NE HAUFHL15NE | 24 24 | 3.3 3.3 | \$730 \$730 |

STORAGE

NOTES:

- Compatible with all HON benching, desking, and height adjustable tables, except where required space is unavailable.
- Ensure weight limit of height adjustable table system is considered before adding undermount storage.
- Open and hinged door units contain a side slot on each side which can be used to hang Workplace Tools.
- Can accommodate two Hot Files, HAEHF, side-by-side.
- 42 lb. storage capacity based on BIFMA loading standards.

 Workplace Tools trays will not fit in cubby.

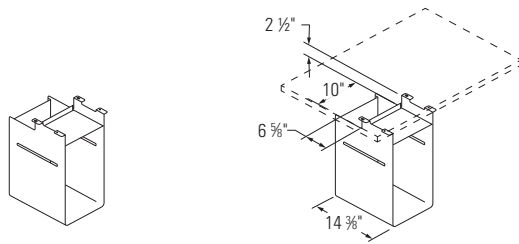

HAUFO15N
Undermount Open Cubby

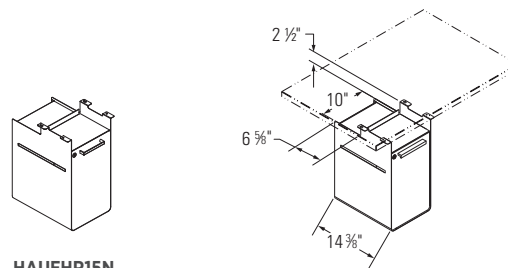



HAUFHR15N
Undermount Storage Cubby
with Locking Door

HOW TO SPECIFY

| | | | |
|---|--|--|---|
| <p>Select Model Number</p> <p>HAUFO15N</p> | <p>Select Case Color</p> <p>See page 717 P2 upcharge (+ \$18) P3 upcharge (+ \$40)</p> <p>P</p> | <p>Select Door Color</p> <p>See page 717 P2 upcharge (+ \$18) P3 upcharge (+ \$40)</p> <p>S</p> | <p>Select Lock Option</p> <p>L Standard Lock X Omit Lock (deduct \$20) EBNL Digital Lock Brushed Nickel (Specify for eLock models only)</p> <p>L</p> |
|---|--|--|---|

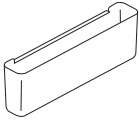

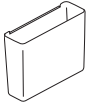
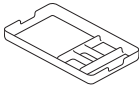
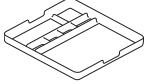
| | DESCRIPTION | MODEL | SHIP WEIGHT | CUBE | LIST PRICE |
|--|---|---------------|-------------|------|-------------|
|  | Side Saddle 12¼"W x 2½"D x 4"H | HAESS | 0.6 | 0.1 | \$42 |
|  | Hook 1⅝"W x 2¼"D x 3¼"H | HAECBH | 0.1 | 0.1 | \$28 |
|  | Hot File 12¼"W x 3⅞"D x 9½"H | HAEHF | 0.7 | 1.5 | \$62 |
|  | Slim Tray 8½"W x 14⅞"D x 1½"H | HAEST | 1.0 | 0.2 | \$55 |
|  | Large Tray 13½"W x 14⅞"D x 1½"H | HAELT | 1.5 | 0.2 | \$62 |

NOTES:

- Side Saddle and Hot File work on Paper Management Support Bars on page 465.
- Hook weight limit 20 lbs.

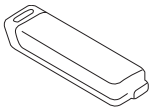
| | DESCRIPTION | MODEL | SHIP WEIGHT | CUBE | LIST PRICE |
|--|--|------------------|-------------|------|--------------|
|  | Digital Keys Digilock Programming Key | HSLDIGPRG | 0.8 | 0.0 | \$181 |
| | Digilock Manager Key | HSLDIGMGR | 0.8 | 0.0 | \$141 |
| | <p>NOTES: A Programming Key is used to initialize locks out of factory default mode and register Manager Keys to the locks. Manager Keys are used to bypass a locked unit, operating as the "master key" and it is recommended that building facilitators have at least one Manager Key. Up to 6 Manager Keys may be registered to each lock. Manager Keys provide external power to locks in case of battery failure. Programming Key is the same key as Contain® Digilocks and can work across both Contain® and Fuse™.</p> <ul style="list-style-type: none"> ! Only one Programming Key should be specified per installation and multiple Programming Keys are not compatible with each other. ! Add-on digital lock orders should be programmed with the original Programming Key. ! Digital lock user guides and manager programming instructions included. | | | | |

HOW TO SPECIFY

| | |
|--|--|
| <p>Select Model Number</p> <p>H A E S S .</p> | <p>Select Color</p> <p>DW Designer White</p> <p>DW</p> |
|--|--|

STORAGE ISLANDS

Want to see more? Scan here
to check out hon.com.



Storage Islands shown with Contain[®] Cubby Lockers, Preside[®] Table, and Cliq[™] Seating.

STORAGE

STORAGE ISLANDS

Time to pack your bags and take flight for an organizational oasis. Storage Islands don't just offer intuitive design and unsurpassed efficiency, they create flexible work suites that will make any project feel like a vacation. Whether you're a creative collaborator or intensely focused on a singular project, these dynamic units are easily customizable with a variety of vibrant color options and offer seamless adaptability to meet the demands of any work day.



FEATURES

- Storage Islands promotes dual-purpose spaces, where functional storage and impromptu collaboration occur simultaneously.
- Clean, straightforward design complements and blends in with any workspace.
- Combine metal, laminate, and color to create a unique and unified look for your office.
- Storage Islands works best with Contain[®] lockers, wardrobes, and Flagship[®] and Brigade[®] laterals.
- Will work with 3-high Flagship[®] and Brigade[®] laterals, bookcases, and storage cabinets along with Contain[®] 42½" lockers and wardrobes.
- Add Storage Islands to existing HON Storage banks or specify in new office configurations.
- Pair storage options to consolidate storage away from the workspace, allowing more room for people to interact, work, and move freely.

STORAGE ISLANDS ORDERING INFORMATION

WORKSURFACES

L1 LAMINATES CODES

Woodgrain

- ◆ Bourbon Cherry H
- ◆ Cognac COGN
- ◆ Florence Walnut LFW1
- ◆ Harvest C
- ◆ Kingswood Walnut LK11
- ◆ Mahogany N
- ◆ Mocha MOCH
- ◆ Natural Maple D
- ◆ Pinnacle PINC
- ◆ Shaker Cherry F
- ◆ Sterling Ash LSA1

Solid

- ◆ Black P
- ◆ Charcoal S
- ◆ Designer White LDW1
- ◆ Loft LOFT

L2 LAMINATES CODES

Woodgrain

- ◆ Lowell Ash LLA1
- ◆ Natural Recon LNR1
- ◆ Phantom Ecru LPE1
- ◆ Portico Teak LPT1
- ◆ Skyline Walnut LSW1

WORKSURFACE EDGE BAND

Woodgrain

- ◆ Bourbon Cherry H
- ◆ Cognac COGN
- ◆ Florence Walnut FW
- ◆ Harvest C
- ◆ Kingswood Walnut KI
- ◆ Lowell Ash DL
- ◆ Mahogany N
- ◆ Mocha MOCH
- ◆ Natural Maple D
- ◆ Natural Recon NR
- ◆ Phantom Ecru PE
- ◆ Pinnacle PINC
- ◆ Portico Teak DP
- ◆ Shaker Cherry F
- ◆ Skyline Walnut SW
- ◆ Sterling Ash SA

Solid

- ◆ Black P
- ◆ Brownstone EY
- ◆ Charcoal S
- ◆ Designer White DW
- ◆ Fossil EH
- ◆ Loft LOFT

O-LEGS

PAINTS CODES

P1

- ◆ Black P
- ◆ Brownstone P7D
- ◆ Charcoal S
- ◆ Designer White PJW
- ◆ Fossil P28
- ◆ Greige T5
- ◆ Loft LOFT
- ◆ Muslin T3
- ◆ Shadow* SHDW
- ◆ Titanium P8T

P2

- ◆ Champagne Metallic T4
- ◆ Platinum Metallic T1
- ◆ Silver PR6
- ◆ Solar Black P8X

P3

- ◆ Amethyst P091
- ◆ Atom P8S
- ◆ Blossom* P8K
- ◆ Bullseye PJF
- ◆ Cabernet* P7T
- ◆ Cobalt Mica P090
- ◆ Conifer* P8H
- ◆ Ember P8P
- ◆ Ion P8N
- ◆ Iris P8J
- ◆ Krypton P8F
- ◆ Ochre P093
- ◆ Regatta P8M
- ◆ Sienna P092
- ◆ Succulent* P8A

* TREND COLORS: These colors are intended to be an inspirational option for the trending market. Product application is limited and color availability is approximately two years to coincide with evolving workplace trends.

◆◆◆ For lead time information see page 19.

* De-emphasized

STORAGE ISLANDS SPECIFYING GUIDE

Top

Available in single depth (18") or double depth (36") surface.

- Select dimensionality based on configuration and the number of undersurface units being spanned.

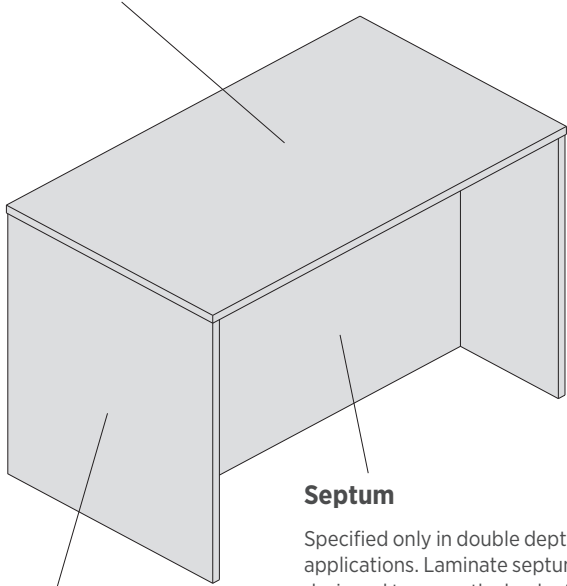

End Panel

Specified in both 18"D and 36"D applications to conceal the sides of storage units.

Septum

Specified only in double depth (36") applications. Laminate septum designed to cover the back of storage units and create a clean countertop application. Septum must be connected to end panels or an adjacent septum.

Back

Specified only in 18"D configurations to conceal the back of storage units.

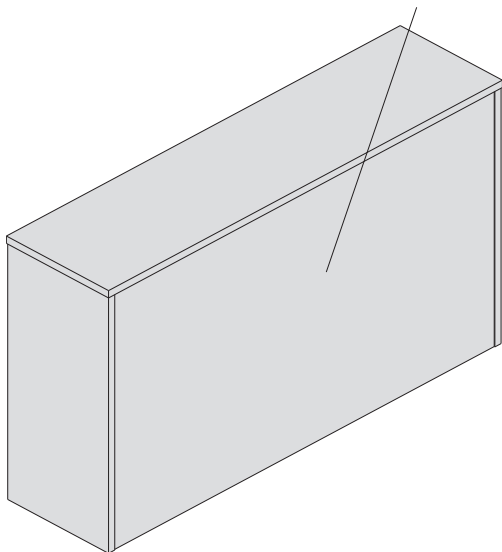

Specifying Islands Top

1. Select top depth.
 - Single (18") or double (36")
2. Select desired Islands configuration.
 - Top only
 - Top + End Panels
 - Top + End Panels + Back or Septum
3. Determine top width.
 - Identify the number of side-to-side storage units the top will cover. This number represents the number of **spans**.

* Note: Front-to-back units do not factor into number of spans. Although top or end panels accept a septum, it is not required to add septum based on application.

Specifying End Panels, Back, or Septum

4. Identify storage units Islands will wrap. This determines correct height.
 - Contain® Height = 40¹/₈"
 - Flagship®/Brigade® Height = 38¹/₈"
5. Specify additional components to complete your Islands configuration.
 - End panels, back, or septum
 - The width and number of units spanned on the septum must match the width and number of units spanned on the top.

Peninsula Applications

Specify an O-Leg or laminate return panel to create an open span collaboration space.

* Note: Under-surface storage must support at least one side of the open span.

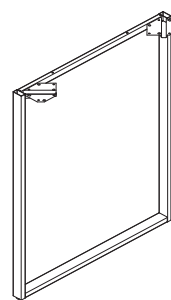

O-Leg

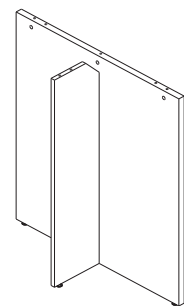

Return Panel

O-Leg & Return Panel

Specified to support open span top in Islands peninsula configuration.

STORAGE ISLANDS SPECIFYING GUIDE

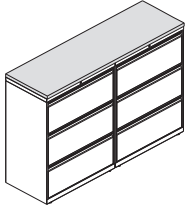

18"D - Single Depth

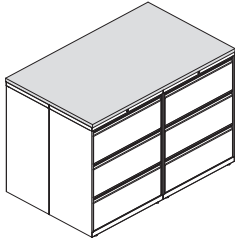

36"D - Double Depth

Light Configuration

Top Only
See page 734 to specify top only.

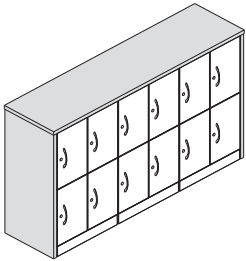

18"D - Single Depth

Medium Configuration

Top + 2 End Panels
See page 735 to specify top designed for end panel configuration.

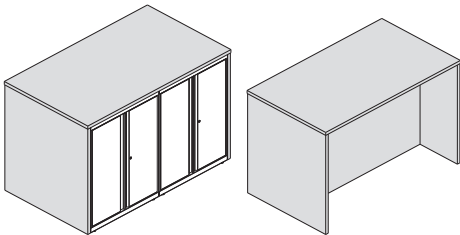

36"D - Double Depth

Heavy Configuration

Top + 2 End Panels + Back (18"D)
Top + 2 End Panels + Septum (36"D)

See page 736 to specify top designed for end panel and back/septum configuration.

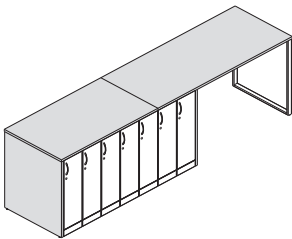

Joined Configuration

Top + 1 End Panel + Septum (36"D)

See page 737 to specify top designed for single end panel and septum configuration.

⚠ This application is designed to join worksurfaces to create a run greater than 84".

NOTES: End panels, backs, septums, and support legs specified separately from tops. See pages 738-739 for specification options.

STORAGE ISLANDS

Planning Typical

| QTY | DESCRIPTION | MODEL | LIST PRICE | PRICE EXTENSION |
|---------------|---|--------------------|----------------|-----------------|
| 1 | Islands Top, Double Depth, Span 2 36"D x 60"W | HSISLAUTNPNB6036S2 | \$593 | \$593 |
| 4 | Brigade® Lateral File, 3 Drawer 30"W x 18"D x 39 1/8"H | H873 | \$1,267 | \$5,068 |
| TOTAL: | | | \$5,661 | |

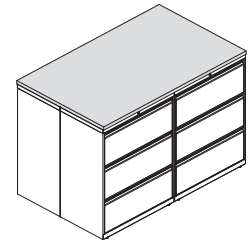

| QTY | DESCRIPTION | MODEL | LIST PRICE | PRICE EXTENSION |
|---------------|--|--------------------|----------------|-----------------|
| 1 | Islands Top for Use w/2 End Panels and Back, Span 3 18"D x 72"W | HSISLAUT2PYB7218S3 | \$458 | \$458 |
| 1 | Islands End Panels, Contain® Height, Back, Left 42"H x 18"W | HSISLACEYB1842L | \$220 | \$220 |
| 1 | Islands End Panels, Contain® Height, Back, Right 42"H x 18"W | HSISLACEYB1842R | \$220 | \$220 |
| 1 | Islands Back, Contain® Height, 2 End Panels, Span 3 42"H x 72"W | HSISLACB2P7242S3 | \$475 | \$475 |
| 3 | Contain® Quad Locker, Plinth Base 42"H x 24"W x 18"D | HSQLP422418RM | \$1,651 | \$4,953 |
| TOTAL: | | | \$6,326 | |

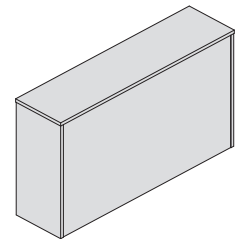
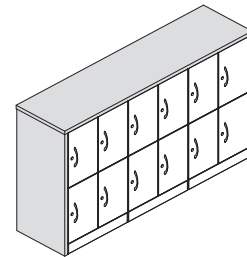

STORAGE

| QTY | DESCRIPTION | MODEL | LIST PRICE | PRICE EXTENSION |
|---------------|---|--------------------|----------------|-----------------|
| 1 | Islands Top for Use w/2 End Panels & Septum, Span 2 36"D x 60"W | HSISLAUT2PYB6036S2 | \$711 | \$711 |
| 2 | Islands End Panel, Flagship® Height, Septum 42"H x 36"W | HSISLAFEB3642 | \$385 | \$770 |
| 1 | Islands Septum, Flagship® Height, 2 End Panels, Span 2 42"H x 60"W | HSISLAFB2P6042S2 | \$405 | \$405 |
| 2 | Flagship® Modular Storage Cabinet 39 1/8"H x 30"W x 18"D | HFMSC183930RWB | \$1,429 | \$2,858 |
| TOTAL: | | | \$4,744 | |

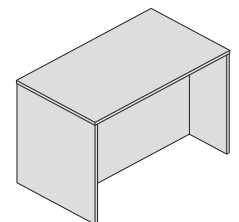
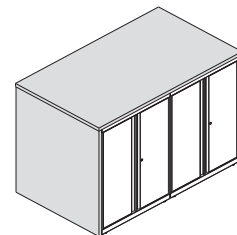

STORAGE ISLANDS

Planning Typical

| QTY | DESCRIPTION | MODEL | LIST PRICE | PRICE EXTENSION |
|---------------|--|--------------------|----------------|-----------------|
| 1 | Islands Top for Use w/2 End Panels and Septum, Span 2 36"D x 84"W | HSISLAUT2PYB8436S2 | \$827 | \$827 |
| 1 | Islands End Panel, Flagship® Height, Back 42"H x 36"W | HSISLAFESP3642 | \$385 | \$385 |
| 1 | Flagship® Height, Return Panel 42"H x 36"W | HSISLAFESP3642 | \$385 | \$385 |
| 2 | Flagship® Bookcase, 3-Shelves 39 1/8"H x 30"W x 18"D | HFSC183640W | \$976 | \$1,952 |
| TOTAL: | | | \$3,549 | |

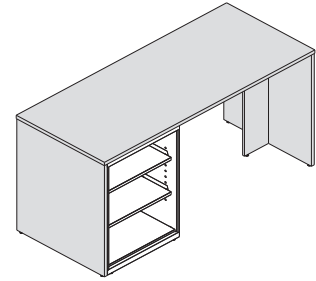

STORAGE

| QTY | DESCRIPTION | MODEL | LIST PRICE | PRICE EXTENSION |
|---------------|---|--------------------|----------------|-----------------|
| 2 | Islands Top for Use w/1 End Panel & Septum, Span 2 36"D x 60"W | HSISLAUT1PYB6036S2 | \$681 | \$1,362 |
| 2 | Islands Septum, Flagship® Height, 2 End Panels, Span 2 42"H x 60"W | HSISLAFB2P6042S2 | \$405 | \$810 |
| 2 | Islands End Panel, Flagship® Height, Septum 42"H x 36"W | HSISLAFEYB3642 | \$385 | \$770 |
| 4 | Flagship® Lateral File, 3 Drawer 39 1/8"H x 30"W x 18"D | H9173(?) | \$1,461 | \$5,844 |
| 1 | Flat Bracket 18"D | HHN831118 | \$70 | \$70 |
| TOTAL: | | | \$8,856 | |

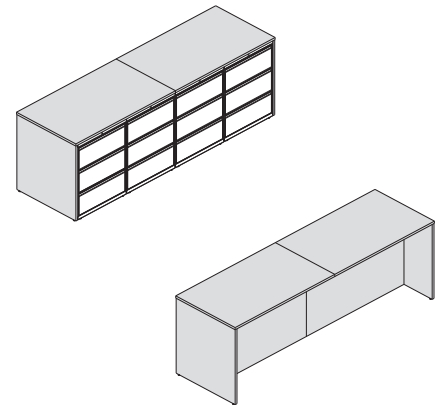

| QTY | DESCRIPTION | MODEL | LIST PRICE | PRICE EXTENSION |
|---------------|--|--------------------|-----------------|-----------------|
| 1 | Islands Top, 1 End Panel and Septum, Span 5 36"D x 60"W | HSISLAUT1PYB6036S5 | \$681 | \$681 |
| 2 | Islands End Panel, Contain® Height, Back, No Septum 42"H x 36"W | HSISLACEYB3642 | \$385 | \$770 |
| 1 | Islands Top, 1 End Panel and Septum, Span 2 36"D x 84"W | HSISLAUT1PYB8436S2 | \$792 | \$792 |
| 1 | Islands O-Leg, Contain® Height 42"H x 36"W | HSISLACO3642 | \$555 | \$555 |
| 2 | External Stiffener Channel 48"W, for 60" Worksurface | HLSLZ5SC60 | \$106 | \$212 |
| 14 | Contain® Wardrobe, Plinth Base 42"H x 12"W x 18"D | HSWP421224RM | \$964 | \$13,496 |
| TOTAL: | | | \$16,506 | |

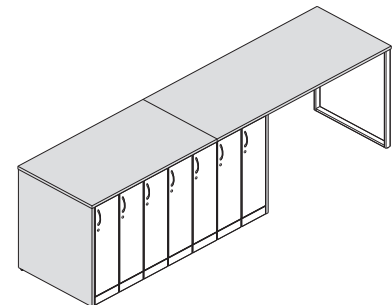

! On joined application, top seam only allowed when supported by storage underneath seam.

STORAGE ISLANDS SPECIFYING GUIDE

WORKING WITH STORAGE ISLANDS WITH CONTAIN® OR FLAGSHIP®/BRIGADE® PRODUCT LINES

Storage Islands come in 2" height variances designed to be used with Contain® or Flagship®/Brigade® product lines. Worksurfaces and end supports are made of 1¼" particleboard with 2mm edgeband and laminate on both sides of all surfaces. Center septums are made of ¾" particleboard with 0.5mm edgeband and laminate on both sides.



| | Depths |
|-------------------------------|--------|
| 18"D No Back, No End Panels | 18.19 |
| 18"D No Back, With End Panels | 18.44 |
| 18"D Back and End Panels | 19.455 |
| 36"D No Back, No End Panels | 36.69 |
| 36"D End Panels | |

| End Panel Sizes | | |
|----------------------------|--------|--------|
| | Depths | Height |
| 18"D No Back, Contain® | 18.19 | 40.8 |
| 18"D No Back, Flagship® | | 38.8 |
| 18"D With Back, Contain® | 19.20 | 40.8 |
| 18"D With Back, Flagship® | | 38.8 |
| 36"D End Panels, Contain® | 36.44 | 40.8 |
| 36"D End Panels, Flagship® | | 38.8 |

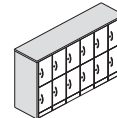
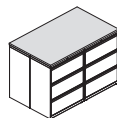

| | Width Sizes | | | | | | |
|---------------|-------------|------------|-----------|------------|----------|------------|-----------|
| | S1 | S2 | S3 | S4 | S5 | S6 | S7 |
| No End Panels | 84.00" | S1 + 0.125 | S1 + 0.25 | S1 + 0.375 | S1 + 0.5 | S1 + 0.625 | S1 + 0.75 |
| 1 End Panel | 85.372" | | | | | | |
| 2 End Panels | 86.744" | | | | | | |

*S1 spans a single storage unit, which is noted at the end of the model number. Start with the S1 number displayed in the table above. Depending on your Islands configuration, the top width increases accordingly based on the 2 factors below.

- 1). The number of end panels you attach to the worksurface.
- 2). The number of side-to-side storage units the surface spans.

NOTES:

- Use the width of the worksurface you select. Models correspond to the correct surface width.
- Span represents the total number of side-to-side units. Front-to-back units do not factor into number of units spanned.

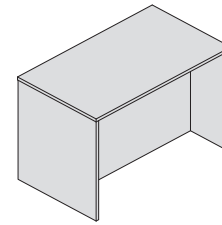

Countertop Application

- When specifying a countertop application, the end of a septum cannot be left open. The septum must connect to an end panel or adjacent septum.

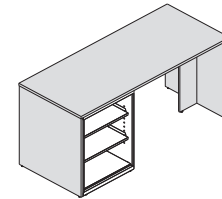

Peninsula Application

- Peninsula applications can only be completed with 36"D worksurfaces and end panels.
- Back-to-back storage specified without an end panel will result in an ~3/8" gap between storage units.
- In a peninsula application, one end of the worksurface must be supported by undersurface storage. The opposing end can be supported with an O-leg or laminate end panel.

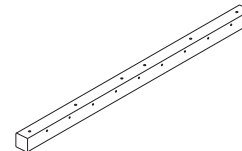

- Unsupported surface runs greater than 54"W require the installation of an external stiffener.
- External stiffener extends 1½" below the worksurface.
- For 36"W surfaces, 2 external stiffeners are needed on the underneath side of the worksurface.

STORAGE ISLANDS

Top Only Applications

OPEN MARKET



Icon Legend on page 19

STORAGE

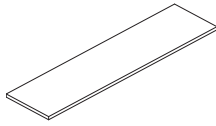
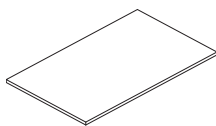
| DESCRIPTION | MODEL | SHIP WEIGHT | CUBE | LIST PRICE BY LAMINATE GRADE | | |
|--|----------------------|--------------------------|------|------------------------------|-------|-------|
| | | | | L1 | L2 | |
|  <p>Islands Tops, Single Depth</p> | 18"D x 24"W, Spans 1 | HSISLAUTNPB2418S1 | 15 | 2.0 | \$217 | \$227 |
| | 18"D x 30"W, Spans 1 | HSISLAUTNPB3018S1 | 18 | 2.5 | \$244 | \$255 |
| | 18"D x 36"W, Spans 1 | HSISLAUTNPB3618S1 | 22 | 2.9 | \$267 | \$279 |
| | 18"D x 36"W, Spans 3 | HSISLAUTNPB3618S3 | 22 | 2.9 | \$284 | \$297 |
| | 18"D x 42"W, Spans 1 | HSISLAUTNPB4218S1 | 25 | 3.3 | \$300 | \$314 |
| | 18"D x 48"W, Spans 1 | HSISLAUTNPB4818S1 | 28 | 3.8 | \$323 | \$338 |
| | 18"D x 48"W, Spans 2 | HSISLAUTNPB4818S2 | 28 | 3.8 | \$323 | \$338 |
| | 18"D x 48"W, Spans 4 | HSISLAUTNPB4818S4 | 28 | 3.8 | \$323 | \$338 |
| | 18"D x 60"W, Spans 1 | HSISLAUTNPB6018S1 | 35 | 4.7 | \$339 | \$354 |
| | 18"D x 60"W, Spans 2 | HSISLAUTNPB6018S2 | 35 | 4.7 | \$339 | \$354 |
| | 18"D x 60"W, Spans 5 | HSISLAUTNPB6018S5 | 35 | 4.7 | \$339 | \$354 |
| | 18"D x 72"W, Spans 1 | HSISLAUTNPB7218S1 | 42 | 5.6 | \$366 | \$383 |
| | 18"D x 72"W, Spans 2 | HSISLAUTNPB7218S2 | 42 | 5.6 | \$366 | \$383 |
| | 18"D x 72"W, Spans 3 | HSISLAUTNPB7218S3 | 42 | 5.6 | \$366 | \$383 |
| | 18"D x 72"W, Spans 6 | HSISLAUTNPB7218S6 | 42 | 5.6 | \$366 | \$383 |
| | 18"D x 84"W, Spans 1 | HSISLAUTNPB8418S1 | 48 | 6.4 | \$394 | \$412 |
| | 18"D x 84"W, Spans 2 | HSISLAUTNPB8418S2 | 48 | 6.4 | \$394 | \$412 |
| | 18"D x 84"W, Spans 7 | HSISLAUTNPB8418S7 | 49 | 6.5 | \$394 | \$412 |
|  <p>Islands Tops, Double Depth</p> | 36"D x 24"W, Spans 1 | HSISLAUTNPB2436S1 | 29 | 3.8 | \$379 | \$396 |
| | 36"D x 30"W, Spans 1 | HSISLAUTNPB3036S1 | 35 | 4.6 | \$428 | \$447 |
| | 36"D x 36"W, Spans 1 | HSISLAUTNPB3636S1 | 42 | 5.3 | \$466 | \$487 |
| | 36"D x 36"W, Spans 3 | HSISLAUTNPB3636S3 | 42 | 5.4 | \$496 | \$518 |
| | 36"D x 42"W, Spans 1 | HSISLAUTNPB4236S1 | 49 | 6.2 | \$525 | \$549 |
| | 36"D x 48"W, Spans 1 | HSISLAUTNPB4836S1 | 56 | 7.0 | \$563 | \$588 |
| | 36"D x 48"W, Spans 2 | HSISLAUTNPB4836S2 | 56 | 7.0 | \$563 | \$588 |
| | 36"D x 48"W, Spans 4 | HSISLAUTNPB4836S4 | 56 | 7.0 | \$563 | \$588 |
| | 36"D x 60"W, Spans 1 | HSISLAUTNPB6036S1 | 69 | 8.6 | \$593 | \$620 |
| | 36"D x 60"W, Spans 2 | HSISLAUTNPB6036S2 | 69 | 8.6 | \$593 | \$620 |
| | 36"D x 60"W, Spans 5 | HSISLAUTNPB6036S5 | 70 | 8.7 | \$593 | \$620 |
| | 36"D x 72"W, Spans 1 | HSISLAUTNPB7236S1 | 83 | 10.3 | \$642 | \$671 |
| | 36"D x 72"W, Spans 2 | HSISLAUTNPB7236S2 | 83 | 10.3 | \$642 | \$671 |
| | 36"D x 72"W, Spans 3 | HSISLAUTNPB7236S3 | 83 | 10.3 | \$642 | \$671 |
| | 36"D x 72"W, Spans 6 | HSISLAUTNPB7236S6 | 83 | 10.3 | \$642 | \$671 |
| | 36"D x 84"W, Spans 1 | HSISLAUTNPB8436S1 | 96 | 11.9 | \$688 | \$719 |
| | 36"D x 84"W, Spans 2 | HSISLAUTNPB8436S2 | 96 | 11.9 | \$688 | \$719 |
| | 36"D x 84"W, Spans 7 | HSISLAUTNPB8436S7 | 97 | 12.0 | \$688 | \$719 |

NOTES:

- Top specified to create "light" configuration . See page 730.
- Worksurfaces are made of 1/8" high-performance particleboard with 2mm edgeband and laminate on both sides of all surfaces.
- Grain direction on all worksurfaces runs horizontal.

HOW TO SPECIFY

| | | |
|---|--|--|
| <p>Select Model Number</p> <p>HSISLAUTNPB6036S5</p> | <p>Select Laminate</p> <p>See page 728</p> <p>LKI1</p> | <p>Select Edge</p> <p>See page 728</p> <p>KI</p> |
|---|--|--|



STORAGE ISLANDS

Tops for Use with 2 End Panels

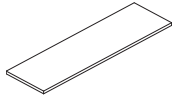

| DESCRIPTION | MODEL | SHIP WEIGHT | CUBE | LIST PRICE BY LAMINATE GRADE | |
|---|---------------------------|-------------|------|------------------------------|-------|
| | | | | L1 | L2 |
| Islands Tops for use with End Panels 18"D x 24"W, 2 End Panels, Spans 1 | HSISLAUT2PNB2418S1 | 17 | 2.2 | \$260 | \$272 |
| 18"D x 30"W, 2 End Panels, Spans 1 | HSISLAUT2PNB3018S1 | 20 | 2.6 | \$293 | \$306 |
| 18"D x 36"W, 2 End Panels, Spans 1 | HSISLAUT2PNB3618S1 | 23 | 3.1 | \$320 | \$334 |
| 18"D x 36"W, 2 End Panels, Spans 3 | HSISLAUT2PNB3618S3 | 23 | 3.1 | \$326 | \$341 |
| 18"D x 42"W, 2 End Panels, Spans 1 | HSISLAUT2PNB4218S1 | 27 | 3.5 | \$360 | \$376 |
| 18"D x 48"W, 2 End Panels, Spans 2 | HSISLAUT2PNB4818S2 | 30 | 4.0 | \$386 | \$403 |
| 18"D x 48"W, 2 End Panels, Spans 4 | HSISLAUT2PNB4818S4 | 30 | 4.0 | \$386 | \$403 |
| 18"D x 60"W, 2 End Panels, Spans 2 | HSISLAUT2PNB6018S2 | 37 | 4.9 | \$406 | \$424 |
| 18"D x 60"W, 2 End Panels, Spans 5 | HSISLAUT2PNB6018S5 | 37 | 4.9 | \$406 | \$424 |
| 18"D x 72"W, 2 End Panels, Spans 2 | HSISLAUT2PNB7218S2 | 44 | 5.8 | \$439 | \$459 |
| 18"D x 72"W, 2 End Panels, Spans 3 | HSISLAUT2PNB7218S3 | 44 | 5.8 | \$439 | \$459 |
| 18"D x 72"W, 2 End Panels, Spans 6 | HSISLAUT2PNB7218S6 | 44 | 5.8 | \$403 | \$421 |
| 18"D x 84"W, 2 End Panels, Spans 2 | HSISLAUT2PNB8418S2 | 51 | 6.6 | \$473 | \$494 |
| 18"D x 84"W, 2 End Panels, Spans 7 | HSISLAUT2PNB8418S7 | 51 | 6.7 | \$473 | \$494 |

NOTES:

- Top specified to create "medium" configuration . See page 730.
- Worksurfaces are made of 1 1/8" high-performance particleboard with 2mm edgeband and laminate on both sides of all surfaces.
- Grain direction on all worksurfaces runs horizontal.

STORAGE

HOW TO SPECIFY

| | | |
|---|---|---|
| <p>Select Model Number</p> <p>HSISLAUT2PNB3618S3</p> | <p>Select Laminate</p> <p>See page 728</p> <p>LKI1</p> | <p>Select Edge</p> <p>See page 728</p> <p>KI</p> |
|---|---|---|

STORAGE ISLANDS

Tops for Use with 2 End Panels and Back/Septum

OPEN MARKET



Icon Legend on page 19

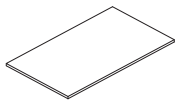
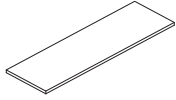

| DESCRIPTION | MODEL | SHIP WEIGHT | CUBE | LIST PRICE BY LAMINATE GRADE | |
|---|---------------------------|-------------|------|------------------------------|--------------|
| | | | | L1 | L2 |
| Islands Tops for Use with 2 End Panels and Back/Septum | | | | | |
| 18"D x 48"W, 2 End Panels and Back, Spans 2 | HSISLAUT2PYB4818S2 | 32 | 4.4 | \$403 | \$421 |
| 18"D x 48"W, 2 End Panels and Back, Spans 4 | HSISLAUT2PYB4818S4 | 32 | 4.4 | \$403 | \$421 |
| 18"D x 60"W, 2 End Panels and Back, Spans 2 | HSISLAUT2PYB6018S2 | 39 | 5.4 | \$423 | \$442 |
| 18"D x 60"W, 2 End Panels and Back, Spans 5 | HSISLAUT2PYB6018S5 | 39 | 5.4 | \$423 | \$442 |
| 18"D x 72"W, 2 End Panels and Back, Spans 2 | HSISLAUT2PYB7218S2 | 46 | 6.3 | \$458 | \$479 |
| 18"D x 72"W, 2 End Panels and Back, Spans 3 | HSISLAUT2PYB7218S3 | 46 | 6.3 | \$458 | \$479 |
| 18"D x 72"W, 2 End Panels and Back, Spans 6 | HSISLAUT2PYB7218S6 | 46 | 6.3 | \$458 | \$479 |
| 18"D x 84"W, 2 End Panels and Back, Spans 2 | HSISLAUT2PYB8418S2 | 53 | 7.3 | \$492 | \$514 |
| 18"D x 84"W, 2 End Panels and Back, Spans 7 | HSISLAUT2PYB8418S7 | 54 | 7.3 | \$492 | \$514 |
| 36"D x 48"W, 2 End Panels and Septum, Spans 2 | HSISLAUT2PYB4836S2 | 59 | 7.4 | \$676 | \$706 |
| 36"D x 48"W, 2 End Panels and Septum, Spans 4 | HSISLAUT2PYB4836S4 | 59 | 7.4 | \$676 | \$706 |
| 36"D x 60"W, 2 End Panels and Septum, Spans 2 | HSISLAUT2PYB6036S2 | 72 | 9.0 | \$711 | \$743 |
| 36"D x 60"W, 2 End Panels and Septum, Spans 5 | HSISLAUT2PYB6036S5 | 73 | 9.0 | \$711 | \$743 |
| 36"D x 72"W, 2 End Panels and Septum, Spans 2 | HSISLAUT2PYB7236S2 | 86 | 10.6 | \$769 | \$804 |
| 36"D x 72"W, 2 End Panels and Septum, Spans 3 | HSISLAUT2PYB7236S3 | 86 | 10.6 | \$769 | \$804 |
| 36"D x 72"W, 2 End Panels and Septum, Spans 6 | HSISLAUT2PYB7236S6 | 86 | 10.7 | \$769 | \$804 |
| 36"D x 84"W, 2 End Panels and Septum, Spans 2 | HSISLAUT2PYB8436S2 | 99 | 12.3 | \$827 | \$864 |
| 36"D x 84"W, 2 End Panels and Septum, Spans 7 | HSISLAUT2PYB8436S7 | 100 | 12.4 | \$827 | \$864 |

NOTES:

- Top specified to create "heavy" configuration . See page 730.
- Worksurfaces are made of 1½" high-performance particleboard with 2mm edgeband and laminate on both sides of all surfaces.
- Grain direction on all worksurfaces runs horizontal.

HOW TO SPECIFY

| | | |
|--|--|--|
| <p>Select Model Number</p> <p>HSISLAUT2PYB6036S2</p> | <p>Select Laminate</p> <p>See page 728</p> <p>LKI1</p> | <p>Select Edge</p> <p>See page 728</p> <p>KI</p> |
|--|--|--|



STORAGE ISLANDS

Islands Tops for Use with 1 End Panel and Septum

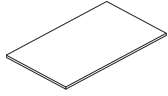

| DESCRIPTION | MODEL | SHIP WEIGHT | CUBE | LIST PRICE BY LAMINATE GRADE | |
|---|---------------------------|-------------|------|------------------------------|--------------|
| | | | | L1 | L2 |
| Islands Tops for Use with One End Panel & Septum | | | | | |
| 36"D x 48"W, 1 End Panel and Septum, Spans 2 | HSISLAUTIPYB4836S2 | 57 | 7.2 | \$648 | \$677 |
| 36"D x 48"W, 1 End Panel and Septum, Spans 4 | HSISLAUTIPYB4836S4 | 57 | 7.2 | \$648 | \$677 |
| 36"D x 60"W, 1 End Panel and Septum, Spans 2 | HSISLAUTIPYB6036S2 | 71 | 8.8 | \$681 | \$712 |
| 36"D x 60"W, 1 End Panel and Septum, Spans 5 | HSISLAUTIPYB6036S5 | 71 | 8.9 | \$681 | \$712 |
| 36"D x 72"W, 1 End Panel and Septum, Spans 2 | HSISLAUTIPYB7236S2 | 84 | 10.5 | \$736 | \$769 |
| 36"D x 72"W, 1 End Panel and Septum, Spans 3 | HSISLAUTIPYB7236S3 | 84 | 10.5 | \$736 | \$769 |
| 36"D x 72"W, 1 End Panel and Septum, Spans 6 | HSISLAUTIPYB7236S6 | 85 | 10.5 | \$736 | \$769 |
| 36"D x 84"W, 1 End Panel and Septum, Spans 2 | HSISLAUTIPYB8436S2 | 98 | 12.1 | \$792 | \$828 |
| 36"D x 84"W, 1 End Panel and Septum, Spans 7 | HSISLAUTIPYB8436S7 | 98 | 12.2 | \$792 | \$828 |

NOTES:

- Worksurfaces are made of 1½" high-performance particleboard with 2mm edgeband and laminate on both sides of all surfaces.
- Grain direction on all worksurfaces runs horizontal.
- Single end panel application designed to join worksurfaces to create run greater than 84".

STORAGE

| DESCRIPTION | MODEL | SHIP WEIGHT | CUBE | LIST PRICE |
|---|------------------|-------------|------|-------------|
|  <p>Flat Bracket 18"D</p> <p>NOTES: Use the flat bracket in countertop applications where 2 worksurfaces come together and there is not a storage unit or end panel connecting them.</p> <p>ⓘ Available in Charcoal only.</p> | HHN831118 | 3 ⓘ | 0.2 | \$70 |

NOTES:

- Top specified to create "joint" configuration. See page 730.
- ⓘ 36"W with back-to-back storage without an end panel will result in approximately ⅜" exposed gap between storage units.

HOW TO SPECIFY

| | | |
|--|--|--|
| <p>Select Model Number</p> <p>HSISLAUT1PYB6036S5</p> | <p>Select Laminate</p> <p>See page 728</p> <p>LK11</p> | <p>Select Edge</p> <p>See page 728</p> <p>KI</p> |
|--|--|--|

STORAGE ISLANDS

Islands Septum/Back and End Panels

OPEN MARKET



Icon Legend on page 19

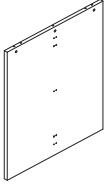

| DESCRIPTION | MODEL | SHIP WEIGHT | CUBE | LIST PRICE BY LAMINATE GRADE | |
|---|------------------------|-------------|------|------------------------------|--------------|
| | | | | L1 | L2 |
| Islands End Panels, Contain® Height | | | | | |
| 42"H x 18"W, Contain® Height, No Back | HSISLACENB1842 | 24 | 3.3 | \$220 | \$230 |
| 42"H x 18"W, Contain® Height, Back, Left-Hand | HSISLACEYB1842L | 26 | 3.3 | \$220 | \$230 |
| 42"H x 18"W, Contain® Height, Back, Right-Hand | HSISLACEYB1842R | 26 | 3.3 | \$220 | \$230 |
| 42"H x 36"W, Contain® Height, No Septum | HSISLACEYB3642 | 45 | 6.0 | \$385 | \$402 |
| 42"H x 36"W, Contain® Height, Septum | HSISLACESP3642 | 45 | 6.0 | \$385 | \$402 |
| Islands End Panels, Flagship® Height | | | | | |
| 42"H x 18"W, Flagship® Height, No Back | HSISLAFENB1842 | 24 | 3.1 | \$220 | \$230 |
| 42"H x 18"W, Flagship® Height, Back, Left-Hand | HSISLAFEYB1842L | 24 | 3.1 | \$220 | \$230 |
| 42"H x 18"W, Flagship® Height, Back, Right-Hand | HSISLAFEYB1842R | 24 | 3.1 | \$220 | \$230 |
| 42"H x 36"W, Flagship® Height, No Septum | HSISLAFEYB3642 | 47 | 5.7 | \$385 | \$402 |
| 42"H x 36"W, Flagship® Height, Septum | HSISLAFESP3642 | 47 | 5.7 | \$385 | \$402 |

NOTES: Panels are made of 1/8" high-performance particleboard with 2mm edgeband and laminate on both sides of all surfaces. Grain direction on all End Panels runs vertical. 18"W end panels require selection of right or left model numbers for installation purposes.

! Models HSISLACESP3642 and HSISLAFESP3642 come with short end panel which can be discarded when used as an end panel.

STORAGE

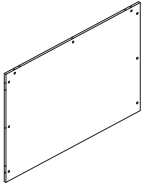

| | | | | | |
|--|-------------------------|----|------|--------------|--------------|
| Islands Septum/Back, Contain® Height | | | | | |
| 42"H x 48"W, 2 End Panels, Spans 2 | HSISLACB2P4842S2 | 42 | 8.1 | \$368 | \$385 |
| 42"H x 72"W, 2 End Panels, Spans 3 | HSISLACB2P7242S3 | 63 | 11.9 | \$475 | \$496 |
| 42"H x 48"W, 2 End Panels, Spans 4 | HSISLACB2P4842S4 | 42 | 8.1 | \$368 | \$385 |
| 42"H x 60"W, 2 End Panels, Spans 5 | HSISLACB2P6042S5 | 53 | 10.0 | \$405 | \$423 |
| 42"H x 72"W, 2 End Panels, Spans 6 | HSISLACB2P7242S6 | 63 | 11.9 | \$475 | \$496 |
| 42"H x 84"W, 2 End Panels, Spans 7 | HSISLACB2P8442S7 | 73 | 13.8 | \$577 | \$603 |
| Islands Septum/Back, Flagship® Height | | | | | |
| 42"H x 60"W, 2 End Panels, Spans 2 | HSISLAFB2P6042S2 | 50 | 10.0 | \$405 | \$423 |
| 42"H x 72"W, 2 End Panels, Spans 2 | HSISLAFB2P7242S2 | 59 | 11.9 | \$475 | \$496 |
| 42"H x 84"W, 2 End Panels, Spans 2 | HSISLAFB2P8442S2 | 69 | 13.7 | \$577 | \$603 |

NOTES: Septums/Backs are made of 3/4" high-performance particleboard with 0.5mm edgeband and laminate on both sides of all surfaces. Grain direction on all Septums/Backs runs horizontal.

NOTES:

- End panels and septum are shipped with mounting hardware included, 1/pack.

HOW TO SPECIFY

| | |
|--|--|
| <p>Select Model Number</p> <p>HSISLACB2P6042S5</p> | <p>Select Laminate</p> <p>See page 728</p> <p>LK11</p> |
|--|--|



STORAGE ISLANDS

Peninsula Supports

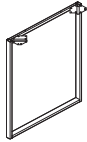

DESCRIPTION

Islands O-Leg
 42”H x 36”W, Contain® Height
 42”H x 36”W, Flagship® Height

| MODEL | SHIP WEIGHT | CUBE | LIST PRICE BY PAINT GRADE | | |
|---------------------|-------------|------|---------------------------|-------|-------|
| | | | P1 | P2 | P3 |
| HSISLACO3642 | 21 | 6.8 | \$555 | \$563 | \$575 |
| HSISLAF03642 | 21 | 6.8 | \$555 | \$563 | \$575 |

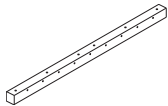

DESCRIPTION

External Support Channel
 42”W for a 54” Open Worksurface Run
 48”W for a 60” Open Worksurface Run
 54”W for a 66” Open Worksurface Run
 60”W for a 72” Open Worksurface Run
 72”W for an 84” Open Worksurface Run

| MODEL | SHIP WEIGHT | CUBE | LIST PRICE |
|-------------------|-------------|------|------------|
| HLSLZ5SC54 | 5 | 0.5 | \$101 |
| HLSLZ5SC60 | 6 | 0.5 | \$106 |
| HLSLZ5SC66 | 7 | 0.5 | \$110 |
| HLSLZ5SC72 | 7 | 0.5 | \$119 |
| HLSLZ5SC84 | 12 | 0.7 | \$119 |

NOTES: 36”W surfaces will need 2 external stiffeners on either side of the worksurface.

ⓘ Available in Graphite paint only.

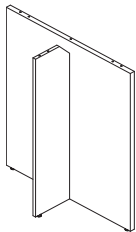

DESCRIPTION

Islands Return Panels
 42”H x 36”W, Contain® Height, Return Panel
 42”H x 36”W, Flagship® Height, Return Panel

| MODEL | SHIP WEIGHT | CUBE | LIST PRICE BY LAMINATE GRADE | |
|-----------------------|-------------|------|------------------------------|-------|
| | | | L1 | L2 |
| HSISLACESP3642 | 56 | 4.6 | \$385 | \$402 |
| HSISLAFESP3642 | 58 | 4.6 | \$385 | \$402 |

NOTES:

- Voi® O-legs installed in peninsula application are centered front-to-back on the worksurface. The O-leg will be ½” inset from the edge of the worksurface.
- ⓘ When specifying a peninsula application, at least one side of the open worksurface span must be supported with undersurface storage. Islands tops cannot be specified with only O-leg or Laminate Return Panel supports.

HOW TO SPECIFY

| | |
|--|--|
| <p>Select Model Number</p> <p>H S I S L A C O 3 6 4 2 . T 1</p> | <p>Select Paint/Laminate</p> <p>See page 728</p> |
|--|--|

STORAGE

400 SERIES

Want to see more? Scan here
to check out hon.com.



STORAGE



400 Series Lateral Files.

400 SERIES

Economical 400 Series lateral files from HON offer features not often found on competitors' files, such as a tamper-resistant enclosed base and factory-installed counterweights on two- and four-drawer cabinets to stabilize the center of gravity when a drawer is opened. Even the removable lock core system stands out among higher-priced rivals.



FEATURES

- Lateral files have counterweights for stability and a two-sided lock mechanism that resists tampering.
- Removable lock core can be changed as security needs require.
- Leveling glides compensate for uneven floors.
- Heavy-duty Steel ball-bearing drawer suspensions operate easily and quietly.
- Four vertical reinforcements keep the cabinet sturdy and the drawers gliding smoothly.
- Drawer handle design coordinates with HON Metro Classic Steel desks.

400 SERIES Lateral Files

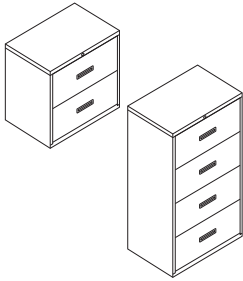

DESCRIPTION

Steel Lateral Files

- 30"W x 18"D x 28"H — 2 Drawer
- 30"W x 18"D x 53½"H — 4 Drawer
- 36"W x 18"D x 28"H — 2 Drawer
- 36"W x 18"D x 53½"H — 4 Drawer

NOTES: Drawers lock. Features ball-bearing slide suspensions.

| MODEL | SHIP WEIGHT | CUBE | LIST PRICE |
|-------------|-------------|------|---------------|
| H432 | 109 | 12.4 | \$864 |
| H434 | 169 | 22.1 | \$1274 |
| H482 | 124 | 12.4 | \$903 |
| H484 | 185 | 22.1 | \$1454 |

NOTES:

- Reinforced case construction.
- Two adjustable leveling glides in front corners.
- Baked enamel finish.
- Monochromatic drawer pulls.
- **HON 5-Year Limited Warranty.**

STORAGE

HOW TO SPECIFY

| | | |
|--|---|--|
| <p>Select Model Number</p> <p>H 4 3 2 .</p> | <p>Select Lock Option</p> <p>L Lock</p> <p>L .</p> | <p>Select Paint Color</p> <p>P Black</p> <p>Q Light Gray</p> <p>LOFT Loft</p> <p>L Putty</p> <p>P</p> |
|--|---|--|

VERTICAL FILES

Want to see more? Scan here
to check out hon.com.



STORAGE

310 Series Verticals with Perpetual® Seating.

VERTICAL FILES

Have lots to store but not a lot to spend? HON has a lot of filing solutions to fit your budget. Perfect for small businesses, home and professional offices, schools and more, HON's vertical files are value priced and available in multiple styles and sizes.



FEATURES

- Our vertical filing cabinets offer both legal and letter drawer sizes to accommodate all your filing needs.
- HON One Key core removable locks can be changed or interchanged as security demands change.
- Double-walled front kickplate stands up to impact.
- High drawer sides support hanging file folders, eliminating the need for extra-cost hangrails.

VERTICAL FILES ORDERING INFORMATION

210, 310, H320 & 510 VERTICAL FILES

PAINTS CODES

P1

| | |
|------------------------|------|
| ◆ Black | P |
| ◆ Brownstone | P7D |
| ◆ Charcoal | S |
| ◆ Designer White | PJW |
| ◆ Fossil | P28 |
| ◆ Greige | T5 |
| ◆ Light Gray | Q |
| ◆ Loft | LOFT |
| ◆ Muslin | T3 |
| ◆ Putty | L |
| ◆ Shadow * | SHDW |
| ◆ Titanium | P8T |

P2

| | |
|----------------------------|----|
| ◆ Champagne Metallic | T4 |
| ◆ Platinum Metallic | T1 |

STORAGE

For Champagne Metallic Paint, Muslin is the suggested edgeband color.

◆◆◆ For lead time information see page 19.

* De-emphasized

210 SERIES Vertical Files

GSA SIN 33721



Icon Legend on page 19



DESCRIPTION

Vertical File — 2 Drawer
15"W x 28½"D x 29"H, Letter
18¼"W x 28½"D x 29"H, Legal

| MODEL | SHIP WEIGHT | CUBE | LIST PRICE BY PAINT GRADE | | |
|--------------|-------------|-------|---------------------------|---------------|---------------|
| | | | P1 | P2 | P3 |
| H212 | 65 | 11.92 | \$915 | \$943 | \$971 |
| H212C | 71 | 14.06 | \$1111 | \$1139 | \$1167 |

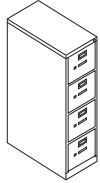

Vertical File — 4 Drawer
15"W x 28½"D x 52"H, Letter
18¼"W x 28½"D x 52"H, Legal

| | | | | | |
|--------------|-----|-------|---------------|---------------|---------------|
| H214 | 114 | 19.64 | \$1189 | \$1234 | \$1278 |
| H214C | 123 | 23.18 | \$1411 | \$1456 | \$1500 |

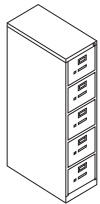

Vertical File — 5 Drawer
15"W x 28½"D x 60"H, Letter
18¼"W x 28½"D x 60"H, Legal

| | | | | | |
|--------------|-----|-------|---------------|---------------|---------------|
| H215 | 136 | 22.31 | \$1588 | \$1633 | \$1677 |
| H215C | 145 | 26.33 | \$1886 | \$1931 | \$1975 |

STORAGE

NOTES:

- High capacity file, 28½" Case depth with 27 front-to-back filing inches per drawer.
- Letter or legal sizes available.
- Three-part, telescoping, steel ball-bearing suspension.
- Bright aluminum drawer pulls, label holders and thumb latch.
- Standard interchangeable core removable locks. Equipped with HON "One Key" system.
- Accepts hanging files. High drawer sides hold hanging file folders without use of hangrails.
- Follower block comes standard.
- Baked enamel finish over rust-inhibiting phosphate pre-treatment.
- See page 748 for Vertical File Accessories.

ⓘ Keyed alike cores must be ordered separately — see page 773.





HOW TO SPECIFY

| | | |
|--|---|---|
| <p>Select Model Number</p> <p>H 2 1 2 .</p> | <p>Select Lock Option</p> <p>P Lock</p> <p>P .</p> | <p>Select Paint Color</p> <p>See page 743</p> <p>T 1</p> |
|--|---|---|

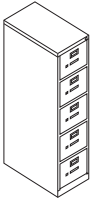

Icon Legend on page 19

310 SERIES Vertical Files

| | DESCRIPTION | MODEL | SHIP WEIGHT | CUBE | LIST PRICE BY PAINT GRADE | | |
|---|---|---|-------------|----------------|--------------------------------|--------------------------------|--------------------------------|
| | | | | | P1 | P2 | P3 |
|  | Vertical File — 2 Drawer 15"W x 26½"D x 29"H, Letter 18¼"W x 26½"D x 29"H, Legal | H312  H312C | 60 66 | 9.2 13.2 | \$546 \$696 | \$574 \$724 | \$602 \$752 |
| | Vertical File — 4 Drawer 15"W x 26½"D x 52"H, Letter 18¼"W x 26½"D x 52"H, Legal | H314  H314C | 107 116 | 16.03 21.76 | \$742 \$911 | \$787 \$956 | \$831 \$1000 |
|  | Vertical File — 5 Drawer 15"W x 26½"D x 60"H, Letter 18¼"W x 26½"D x 60"H, Legal | H315  H315C | 128 137 | 20.94 24.72 | \$1088 \$1300 | \$1133 \$1345 | \$1177 \$1389 |

STORAGE

NOTES:

- 26½" Case depth with 25 front-to-back filing inches per drawer.
- Letter or legal sizes available.
- Three-part, telescoping, steel ball-bearing suspension.
- Bright aluminum drawer pulls, label holders and thumb latch.
- Standard interchangeable core removable locks. Equipped with HON "One Key" system.
- Accepts hanging files. High drawer sides hold hanging file folders without use of hangrails.
- Follower block comes standard.
- Baked enamel finish over rust-inhibiting phosphate pre-treatment.
- See page 748 for Vertical File Accessories.

 Keyed alike cores must be ordered separately — see page 773.

HOW TO SPECIFY

| | | |
|--|---|---|
| <p>Select Model Number</p> <p>H 3 1 2 .</p> | <p>Select Lock Option</p> <p>P Lock</p> <p>P .</p> | <p>Select Paint Color</p> <p>See page 743</p> <p>T 1</p> |
|--|---|---|

510 SERIES Vertical Files

GSA SIN 33721



Icon Legend on page 19



DESCRIPTION

Vertical File — 2 Drawer
15"W x 25"D x 29"H, Letter
18¼"W x 25"D x 29"H, Legal

| MODEL | SHIP WEIGHT | CUBE | LIST PRICE BY PAINT GRADE | | |
|-------|-------------|------|---------------------------|-------|-------|
| | | | P1 | P2 | P3 |
| H512 | 58 | 8.12 | \$479 | \$507 | \$535 |
| H512C | 63 | 9.71 | \$612 | \$640 | \$668 |

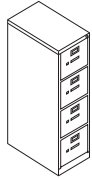

Vertical File — 4 Drawer
15"W x 25"D x 52"H, Letter
18¼"W x 25"D x 52"H, Legal

| | | | | | |
|-------|-----|-------|-------|-------|-------|
| H514 | 102 | 17.42 | \$645 | \$690 | \$734 |
| H514C | 112 | 20.65 | \$791 | \$836 | \$880 |

NOTES:

- 25" Case depth with 23½" front-to-back filing inches per drawer.
- Letter and legal sizes are available.
- Three-part telescoping, ball-bearing steel suspension.
- Bright aluminum drawer pulls, label holders and thumb latch.
- Standard interchangeable core removable locks. Equipped with HON "One Key" system.
- Accepts hanging files. High drawer sides hold hanging file folders without use of hangrails.
- Adjustable wire follower.
- Baked enamel finish over rust-inhibiting phosphate pre-treatment.

Keyed alike cores must be ordered separately — see page 773.





STORAGE

HOW TO SPECIFY

| | | |
|--|---|---|
| <p>Select Model Number</p> <p>H 5 1 2 .</p> | <p>Select Lock Option</p> <p>P Lock</p> <p>P .</p> | <p>Select Paint Color</p> <p>See page 743</p> <p>T 1</p> |
|--|---|---|

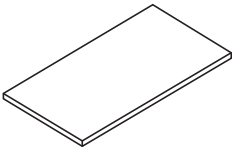
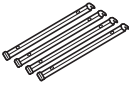

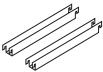
LATERAL FILE ACCESSORIES

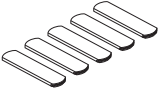

| | DESCRIPTION | MODEL | SHIP WEIGHT | CUBE | LIST PRICE |
|---|---|----------------|-------------|------|--------------|
|  | Square Edge Laminate Top | | | | |
| | 30"W x 18"D x 1/8" Thick | H919430 | 20.0 | 1.6 | \$451 |
| | 36"W x 18"D x 1/8" Thick | H919436 | 25.0 | 1.8 | \$565 |
| | 42"W x 18"D x 1/8" Thick | H919442 | 30.0 | 2.1 | \$617 |
| | 60"W x 18"D x 1/8" Thick | H919460 | 32.0 | 3.0 | \$780 |
| | 66"W x 18"D x 1/8" Thick | H919466 | 40.0 | 3.2 | \$892 |
| | 72"W x 18"D x 1/8" Thick | H919472 | 48.0 | 3.5 | \$915 |
| NOTES: Compatible with Flagship® and Brigade® 18"D Lateral Files only. Laminate tops are abrasion- and stain-resistant laminate. See Storage Islands pages for broad offering of laminate top options compatible with Contain®, Flagship®, and Brigade®. | | | | | |
|   | Single Rail Hanging File Racks (4/pack) | H919491 | 1.0 | 0.4 | \$75 |
| | NOTES: For front-to-back filing — 30"W, 36"W and 42"W files. Order one package per drawer for 42"W files. One package will do two 30"W or 36"W file drawers. Racks span between 15 1/4"W rails. Hanging file racks and dividers available in Gray only. | | | | |
|  Gray only. | | | | | |
|   | Double-Rail Hanging File Racks (2/pack) | H919492 | 1.5 | 0.4 | \$75 |
| | NOTES: For 3 rows front-to-back — 42"W files. Order one package per drawer. Racks span between 15 1/4"W rails. Hanging file racks and dividers available in Gray only. | | | | |
|  Gray only. | | | | | |
|  | Magnetic Label Holder | H919493 | 1.6 | 0.1 | \$22 |
| | 5 pack | | | | |

NOTES:

- Compatible with Flagship®, Brigade® 800, 700, 600, and 500 Series Lateral Files.
- See Contain® Accessories for hanging file racks compatible with Contain® Storage Products.

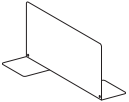

HOW TO SPECIFY

| | |
|---|--|
| Select Model Number <input type="text" value="H"/> <input type="text" value="9"/> <input type="text" value="1"/> <input type="text" value="9"/> <input type="text" value="4"/> <input type="text" value="3"/> <input type="text" value="0"/> <input type="text" value="."/> | Select Laminate See page 653 <input type="text" value="N"/> |
|---|--|

| | DESCRIPTION | MODEL | SHIP WEIGHT | CUBE | LIST PRICE |
|---|---------------------------|-----------------|-------------|------|--------------|
|  | Metal File Divider | | | | |
| | 10 pack | HSCAFD10 | 12 | 0.7 | \$224 |
| | 2 pack | HSCAFD02 | 3 | 0.7 | \$60 |
|  Metal dividers available in Black only. No need to specify. | | | | | |



VERTICAL FILE ACCESSORIES

| | DESCRIPTION | MODEL | SHIP WEIGHT | CUBE | LIST PRICE |
|---|--|--------------|-------------|------|--------------|
|  SIN 33721 | Follower Block (4/pack) | | | | |
| | Legal | HF60 | 8.0 | 0.6 | \$117 |
| | Letter | HF50 | 7.0 | 0.5 | \$111 |
|  Lock info page 773. | Chrome Core Removable Lock Kit (Field installable) | HF24 | 0.2 | 0.2 | \$67 |
| | Bulk Package — 6 HF24 Lock Kits (Individually shrink wrapped) | HF246 | 1.2 | 0.2 | \$310 |
| OPEN MARKET | | | | | |

HOW TO SPECIFY

Select
Model Number

HF60



Icon Legend on page 19

MOBILE PEDESTALS

| | DESCRIPTION | MODEL | SHIP WEIGHT | CUBE | LIST PRICE |
|--|---|--------------------------------|-------------|------------|------------------------------|
| | Mobile Pedestal 15"W x 20"D x 28"H, Box/Box/File 15"W x 20"D x 28"H, File/File | HBMP2B HBMP2F | 60 60 | 6.9 6.9 | \$579 \$579 |

NOTES:

- Pencil tray standard in top box drawer.
- One box divider standard in each box drawer.
- One crossrail standard in each file drawer.
- Ball-bearing suspension with 90% extension.
- Steel frame construction for everyday use.
- **HON 5-Year Limited Warranty.**

STORAGE

HOW TO SPECIFY

| | |
|---|--|
| <p>Select Model Number</p> <p>HBMP2B . P</p> | <p>Select Paint Color</p> <p>P Black Q Light Gray L Putty</p> |
|---|--|



PEDESTAL ACCESSORIES

Icon Legend on page 19

STORAGE

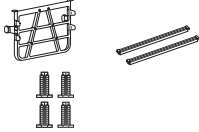
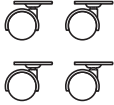
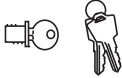

| | DESCRIPTION | MODEL | SHIP WEIGHT | CUBE | LIST PRICE |
|--|--|--|------------------------------|-------------------|---|
| | Counterweight — Freestanding Support Pedestals or Systems Support and Mobile Pedestals | HPCW1 | 18.0 | 0.1 | \$223 |
|  | Follower Block — 1-Pack. Gray only. Double-Rail Hanging File Racks — 2-Pack. Gray only (for side-to-side). Adjustable Glides — 4-Pack Field installable, used to convert mobile pedestals to freestanding support pedestals. NOTES: Hardware included. Compatible with Contain®. | HF80 H519495 H20040AG | 1.0 0.5 1.0 | 0.3 0.5 0.6 | \$55 \$39 \$72 |
|  | Caster Package — Field Installable Four Casters (2 swivel, 2 fixed) NOTES: Used to convert Freestanding Support Pedestals to Mobile Pedestals. Does not work on Contain® or Flagship® B/F mobile pedestals. ! Not designed to be used on pedestals without a counterweight. | H1050CST | 1.0 Ⓢ | 0.6 | \$51 |
|  | Lock Core Replacement Kit — Chrome (Specify quantity of each key number from 101E-225E.) Contains one core, two keys, one core removable tool and instructions. Refer to page 773. SIN 33721 Master Key (one key) — Available to authorized dealers only. OPEN MARKET | HF23C HF22 | 0.1 Ⓢ 0.1 Ⓢ | 0.1 0.1 | \$49 \$30 |

NOTES:
• Compatible with Flagship®, Brigade® and Systems Support Pedestals.

HOW TO SPECIFY

Select Model Number

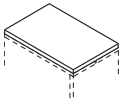
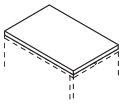
H F 2 3 C

| | DESCRIPTION | MODEL | SHIP WEIGHT | CUBE | FABRIC PRICE CODES | | | | | | | | | | | | | | | | | | | | | | | | | | | | |
|--|--|-------------------|---------------|------|--|---|-------|---|-------|---|-------|---|-------|---|-------|----|-------|---|-------|----|-------|---|-------|----|-------|---|-------|---|---|---|-------|--|--|
|  OPEN MARKET | Pedestal Seat 15"W x 18"D x 2"H NOTES: For seating fabrics, see pages 22-24. Works with Contain® and Flagship® Pedestals and Mobile Pedestals. | HPSEAT18ND | 16.3 Ⓢ | 0.9 | <table border="0"> <tr><td>1</td><td>\$189</td><td>8</td><td>\$385</td></tr> <tr><td>2</td><td>\$213</td><td>9</td><td>\$416</td></tr> <tr><td>3</td><td>\$237</td><td>10</td><td>\$447</td></tr> <tr><td>4</td><td>\$261</td><td>11</td><td>\$478</td></tr> <tr><td>5</td><td>\$292</td><td>12</td><td>\$509</td></tr> <tr><td>6</td><td>\$323</td><td>L</td><td>—</td></tr> <tr><td>7</td><td>\$354</td><td></td><td></td></tr> </table> | 1 | \$189 | 8 | \$385 | 2 | \$213 | 9 | \$416 | 3 | \$237 | 10 | \$447 | 4 | \$261 | 11 | \$478 | 5 | \$292 | 12 | \$509 | 6 | \$323 | L | — | 7 | \$354 | | |
| 1 | \$189 | 8 | \$385 | | | | | | | | | | | | | | | | | | | | | | | | | | | | | | |
| 2 | \$213 | 9 | \$416 | | | | | | | | | | | | | | | | | | | | | | | | | | | | | | |
| 3 | \$237 | 10 | \$447 | | | | | | | | | | | | | | | | | | | | | | | | | | | | | | |
| 4 | \$261 | 11 | \$478 | | | | | | | | | | | | | | | | | | | | | | | | | | | | | | |
| 5 | \$292 | 12 | \$509 | | | | | | | | | | | | | | | | | | | | | | | | | | | | | | |
| 6 | \$323 | L | — | | | | | | | | | | | | | | | | | | | | | | | | | | | | | | |
| 7 | \$354 | | | | | | | | | | | | | | | | | | | | | | | | | | | | | | | | |
|  OPEN MARKET  | Pedestal Seat 15"W x 22 7/8"D x 2"H NOTES: For seating fabrics, see pages 22-24. Works with Contain® and Flagship® Pedestals and Mobile Pedestals. | HPSEAT24ND | 10.0 Ⓢ | 1.2 | <table border="0"> <tr><td>1</td><td>\$222</td><td>8</td><td>\$418</td></tr> <tr><td>2</td><td>\$246</td><td>9</td><td>\$449</td></tr> <tr><td>3</td><td>\$270</td><td>10</td><td>\$480</td></tr> <tr><td>4</td><td>\$294</td><td>11</td><td>\$511</td></tr> <tr><td>5</td><td>\$325</td><td>12</td><td>\$542</td></tr> <tr><td>6</td><td>\$356</td><td>L</td><td>—</td></tr> <tr><td>7</td><td>\$387</td><td></td><td></td></tr> </table> | 1 | \$222 | 8 | \$418 | 2 | \$246 | 9 | \$449 | 3 | \$270 | 10 | \$480 | 4 | \$294 | 11 | \$511 | 5 | \$325 | 12 | \$542 | 6 | \$356 | L | — | 7 | \$387 | | |
| 1 | \$222 | 8 | \$418 | | | | | | | | | | | | | | | | | | | | | | | | | | | | | | |
| 2 | \$246 | 9 | \$449 | | | | | | | | | | | | | | | | | | | | | | | | | | | | | | |
| 3 | \$270 | 10 | \$480 | | | | | | | | | | | | | | | | | | | | | | | | | | | | | | |
| 4 | \$294 | 11 | \$511 | | | | | | | | | | | | | | | | | | | | | | | | | | | | | | |
| 5 | \$325 | 12 | \$542 | | | | | | | | | | | | | | | | | | | | | | | | | | | | | | |
| 6 | \$356 | L | — | | | | | | | | | | | | | | | | | | | | | | | | | | | | | | |
| 7 | \$387 | | | | | | | | | | | | | | | | | | | | | | | | | | | | | | | | |

HOW TO SPECIFY

Select Model Number

Select Fabric

See pages 22-24 for seating fabric options

H P S E A T 2 4 . A P N 2 3



Icon Legend on page 19

PEDESTAL ACCESSORIES

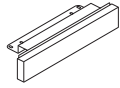

DESCRIPTION

Flush Front Kick Plate
For 28"H Flagship® Pedestals

| MODEL | SHIP WEIGHT | CUBE | LIST PRICE BY PAINT GRADE | | |
|---------|-------------|------|---------------------------|-------|-------|
| | | | P1 | P2 | P3 |
| HKP2800 | 3 Ⓞ | 0.2 | \$130 | \$138 | \$143 |

NOTES:

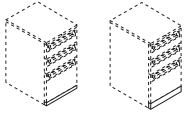

- Mounts to base of pedestal to provide a flush appearance to coordinate with laterals, file centers and storage towers.
- Kick plate is field installable.

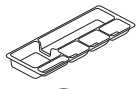

DESCRIPTION

Optional Pencil Tray

NOTES: For additional information see the Workplace Tools section in the 2021 Shared Spaces Pricer.

- ⓘ For use with mobile and freestanding pedestal models.
- ⓘ No specification required.

| MODEL | SHIP WEIGHT | CUBE | LIST PRICE |
|--------|-------------|------|------------|
| HV-UT1 | 0.5 | 0.1 | \$77 |



STORAGE

HOW TO SPECIFY

| | |
|--|---|
| <p>Select Model Number</p> <p>H K P 2 8 0 0 .</p> | <p>Select Paint Color</p> <p>See page 653</p> <p>P</p> |
|--|---|

LAMINATE BOOKCASES

Want to see more? Scan here
to check out hon.com.



STORAGE

1870 Series Bookcases.



LAMINATE BOOKCASES

These sturdy laminate bookcases coordinate with most HON laminate desks. The scratch-, spill- and stain-resistant laminate will ensure that they keep their good looks.

1870 SERIES FEATURES

- Shelves adjust on 1/4" increments.
- Leveling glides keep them nicely aligned, even if the floor isn't.
- Easy to assemble, using high-precision cam-locks and wood dowels, with no glue needed.



10500 SERIES FEATURES

- Ship fully assembled and ready to use.
- Adjustable leveling glides compensate for uneven floors.
- Available in a broad palette of laminate colors.



BOOKCASES ORDERING INFORMATION

10500 SERIES™ BOOKCASES

L1 LAMINATES CODES

Woodgrain

- ◆ Bourbon Cherry H
- ◆ Cognac COGN
- ◆ Florence Walnut LFW1
- ◆ Harvest C
- ◆ Kingswood Walnut LK11
- ◆ Mahogany N
- ◆ Mocha MOCH
- ◆ Natural Maple D
- ◆ Pinnacle PINC
- ◆ Shaker Cherry F
- ◆ Sterling Ash LSA1

Solid

- ◆ Black P
- ◆ Charcoal S
- ◆ Designer White LDW1
- ◆ Loft LOFT

Patterned Top*

- ◆ Handspun Chestnut LAHC
- ◆ Handspun Dove LAHD
- ◆ Handspun Pearl LAHP
- ◆ Handspun Slate LAHS
- ◆ Sheer Mesh * A5
- ◆ Silver Mesh B9
- ◆ Canyon Zephyr * K9
- ◆ Desert Zephyr * K8
- ◆ Grey Tigris * L6

L2 LAMINATES CODES

Woodgrain

- ◆ Lowell Ash LLA1
- ◆ Natural Recon LNR1
- ◆ Phantom Ecru LPE1
- ◆ Portico Teak LPT1
- ◆ Skyline Walnut LSW1

1870 SERIES BOOKCASES

L1 LAMINATES CODES

Woodgrain

- ◆ Cognac COGN
- ◆ Harvest C
- ◆ Mahogany N

10500 Series™ Laminate Bookcases

- Available Laminate Colors:

| Woodgrain | Solid | Patterned Top* | Two-Tone (Top/Chassis) |
|--|---|---|--|
| Top and edgingband are the same, chassis is different laminate color: | | | |
| L1 Laminates: Bourbon Cherry (HH) Cognac (COGNCOGN) Florence Walnut (LFWILFW1) Harvest (CC) Kingswood Walnut (LK11LK11) Mahogany (NN) Mocha (MOCHMOCH) Natural Maple (DD) Pinnacle (PINCPINC) Shaker Cherry (FF) Sterling Ash (LSA1LSA1) | Black (PP) Charcoal (SS) Designer White (LDWILDW1) Loft (LOFTLOFT) | Canyon Zephyr (K9) Desert Zephyr (K8) Grey Tigris (L6) Handspun Chestnut (LAHC) Handspun Dove (LAHD) Handspun Pearl (LAHP) Handspun Slate (LAHS) Sheer Mesh (A5) Silver Mesh (B9) | Black/Charcoal (PS) Black/Designer White (PLDW1) Black/Loft (PLOFT) Bourbon Cherry/Black (HP) Bourbon Cherry/Charcoal (HS) Bourbon Cherry/Designer White (HLDW1) Bourbon Cherry/Loft (HLOFT) Charcoal/Black (SP) Charcoal/Designer White (SLDW1) Cognac/Black (COGNP) Cognac/Charcoal (COGNS) Cognac/Designer White (COGNLDW1) Cognac/Loft (COGNLOFT) Designer White/Black (LDWIP) Designer White/Bourbon Cherry (LDWIH) Designer White/Charcoal (LDWIS) Designer White/Cognac (LDWICOGN) Designer White/Harvest (LDWIC) Designer White/Loft (LDWILOFT) Designer White/Lowell Ash (LDWILLA10) Designer White/Mahogany (LDWIN) Designer White/Mocha (LDWIMUCH) Designer White/Natural Maple (LDWID) Designer White/Natural Recon (LDWILNR1) Designer White/Phantom Ecru (LDWILPE1) Designer White/Pinnacle (LDWIPINC) Designer White/Portico Teak (LDWILPT1) Designer White/Shaker Cherry (LDWIF) Designer White/Skyline Walnut (LDWILSW1) Florence Walnut/Black (LFWIP) Florence Walnut/Charcoal (LFWIS) Florence Walnut/Designer White (LFWILDW1) Florence Walnut/Loft (LFWILOFT) Harvest/Black (CP) Harvest/Charcoal (CS) Harvest/Designer White (CLDW1) Harvest/Loft (CLOFT) Kingswood Walnut/Black (LK1IP) Kingswood Walnut/Charcoal (LK1IS) Kingswood Walnut/Designer White (LK1ILDW1) Kingswood Walnut/Loft (LK1ILOFT) Loft/Black (LOFTP) Loft/Charcoal (LOFTS) Loft/Designer White (LOFTLDW1) Lowell Ash/Black (LLAIP) Lowell Ash/Charcoal (LLAIS) Lowell Ash/Designer White (LLAILDW1) Lowell Ash/Loft (LLAILOFT) |
| L2 Laminates: Lowell Ash (LLA1) Natural Recon (LNR1) Phantom Ecru (LPE1) Portico Teak (LPT1) Skyline Walnut (LSW1) | | *Patterned Laminates are available with the following chassis/edgingband laminate selection: Black (P) Bourbon Cherry (H) Charcoal (S) Designer White (LDW1) Florence Walnut (LFW1) Harvest (CC) Kingswood Walnut (LK11) Loft (LOFT) Mahogany (N) Natural Maple (D) Shaker Cherry (F) Sterling Ash (LSA1) | Mahogany/Black (NP) Mahogany/Charcoal (NS) Mahogany/Designer White (NLDW1) Mahogany/Loft (NLOFT) Mocha/Black (MOCHP) Mocha/Charcoal (MOCHS) Mocha/Designer White (MOCHLDW1) Mocha/Loft (MOCHLOFT) Natural Maple/Black (DP) Natural Maple/Charcoal (DS) Natural Maple/Designer White (DLDW1) Natural Maple/Loft (DLOFT) Natural Recon/Black (LNRIP) Natural Recon/Charcoal (LNRIS) Natural Recon/Designer White (LNRILDW1) Natural Recon/Loft (LNRILOFT) Phantom Ecru/Black (LPEIP) Phantom Ecru/Charcoal (LPEIS) Phantom Ecru/Designer White (LPEILDW1) Phantom Ecru/Loft (LPEILOFT) Pinnacle/Black (PINCP) Pinnacle/Charcoal (PINCS) Pinnacle/Designer White (PINCLDW1) Pinnacle/Loft (PINCLLOFT) Portico Teak/Black (LPTIP) Portico Teak/Charcoal (LPTIS) Portico Teak/Designer White (LPTILDW1) Portico Teak/Loft (LPTILOFT) Shaker Cherry/Black (FP) Shaker Cherry/Charcoal (FS) Shaker Cherry/Designer White (FLDW1) Shaker Cherry/Loft (FLOFT) Skyline Walnut/Black (LSWIP) Skyline Walnut/Charcoal (LSWIS) Skyline Walnut/Designer White (LSWILDW1) Skyline Walnut/Loft (LSWILOFT) Sterling Ash/Black (LSAIP) Sterling Ash/Charcoal (LSAIS) Sterling Ash/Designer White (LSAILDW1) Sterling Ash/Loft (LSAILOFT) |
| | | Edgingband around top will match chassis laminate color selected. | |

Patterned Top

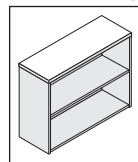

Edgeband Around Top/Laminate Base

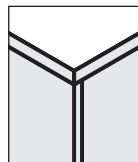

Two-Tone Laminate Top/Edgebanding

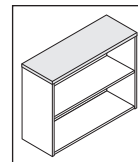

Laminate Base

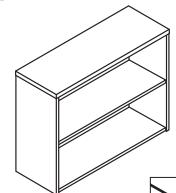
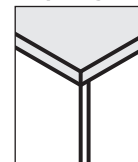

Square Corner Edge Detail



* NOTE: For patterned top laminates, select one of the following for the edgeband around the top, the shelves and vertical panels — Black (P), Bourbon Cherry (H), Charcoal (S), Cognac (COGN), Designer White (DW), Florence Walnut (LFW1), Harvest (C), Kingswood Walnut (LK11), Mahogany (N), Mocha (MOCH), Natural Maple (D), Pinnacle (PINC), Shaker Cherry (F), and Sterling Ash (LSA1).

◆◆◆ For lead time information see page 19.

* De-emphasized

10500 SERIES™ Laminate Bookcases

GSA SIN 33721



Icon Legend on page 19

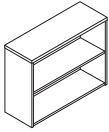

| DESCRIPTION | MODEL | SHIP WEIGHT | CUBE | L1 LIST PRICE | L2 LIST PRICE |
|---|----------------|-------------|------|---------------|---------------|
| Laminate Bookcase | | | | | |
| 36"W x 13 ¹ / ₈ "D x 29 ³ / ₈ "H, 2-Shelf | H105532 | 90 | 11.0 | \$503 | \$518 |
| 36"W x 13 ¹ / ₈ "D x 43 ³ / ₈ "H, 3-Shelf | H105533 | 122 | 15.6 | \$639 | \$659 |
| 36"W x 13 ¹ / ₈ "D x 57 ¹ / ₈ "H, 4-Shelf | H105534 | 156 | 20.2 | \$753 | \$778 |
| 36"W x 13 ¹ / ₈ "D x 71"H, 5-Shelf | H105535 | 187 | 25.1 | \$875 | \$905 |

NOTES: Ships fully assembled. Fixed shelves. Inside shelf dimensions on all units are 33¹/₈"W x 11¹⁵/₁₆"D x 12¹⁵/₁₆"H.

NOTES:

- 10500 Series™ Caseloads smooth, flat edge detail (see pages 274-325) complements many furniture designs.
- Fully finished back.
- Replaces 1980 Series Laminate Bookcases.
- Bottom shelf, top and end panels are 1¹/₈" thick. Interior shelves are 3³/₄" thick.
- All surfaces finished in abrasion- and stain-resistant thermal-fused laminate over solid core high-performance particleboard.
- Adjustable hex leveling glides allow floor-standing bookcases to be easily leveled without lifting the unit; glides have 3³/₄" adjustable range.

STORAGE

HOW TO SPECIFY

| | |
|---|---|
| <p>Select Model Number</p> <p>H 1 0 5 5 3 2 .</p> | <p>Select Laminate</p> <p>See page 753</p> <p>N N</p> |
|---|---|



Icon Legend on page 19

1870 SERIES Laminate Bookcases

| | DESCRIPTION | MODEL | SHIP WEIGHT | CUBE | LIST PRICE |
|--------------|--|--------------|-------------|--------------|--------------|
| | Laminate Bookcase | | | | |
| | 36"W x 11½"D x 29⅞"H, 2-Shelf (1 adjustable) | H1871 | 48 | 1.5 | \$268 |
| | 36"W x 11½"D x 36⅞"H, 3-Shelf (2 adjustable) | H1872 | 60 | 1.7 | \$297 |
| | 36"W x 11½"D x 48⅜"H, 4-Shelf (3 adjustable) | H1874 | 77 | 2.6 | \$359 |
| | 36"W x 11½"D x 60⅞"H, 5-Shelf (3 adjustable) | H1875 | 92 | 2.8 | \$421 |
| | 36"W x 11½"D x 72⅝"H, 6-Shelf (4 adjustable) | H1876 | 109 | 3.4 | \$483 |
| | 36"W x 11½"D x 84"H, 6-Shelf (4 adjustable) | H1877 | 124 | 4.5 | \$549 |
| | Set of doors with hinges used to conceal lower shelf contents | | | | |
| 36"W x 25¾"H | H1801 | 23 Ⓞ | 1.0 | \$222 | |

NOTES:

- Square edge profile complements many different furniture designs.
- Abrasion- and stain-resistant laminate, over durable solid core, high-performance particleboard.
- ¾" thick shelves adjust in ¼" increments to suit a variety of storage needs (two shelves are fixed in 5- and 6-shelf units).
- Cam-lock fasteners and wood dowels ensure pieces go together easily and precisely.
- Equipped with four adjustable leveling glides.
- Shelves will deflect under large amounts of weight.
- ⅛" hardboard back panel.
- All bookcases are 36"W x 11½"D.
- Optional doors available to conceal lower shelf contents.
- Easy-to-assemble instructions included.

! Designed to be used in small office-home office applications.

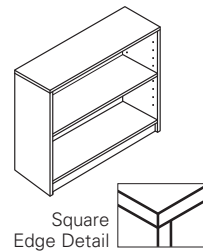

STORAGE

HOW TO SPECIFY

| | |
|--|--|
| <p>Select Model Number</p> <p>H 1 8 7 1 . N</p> | <p>Select Laminate</p> <p>COGN Cognac C Harvest N Mahogany</p> |
|--|--|

NOTES

STORAGE

ACOUSTIC SOLUTIONS

by unika vaev

Want to see more? Scan here
to check out hon.com.



**Drift ecoustic® Flat Surface Tiles shown
with Flock® Dual Fabric Square Chair.**

UNIKA VAEV

The workplace as we know it is evolving. With the increasing popularity of open concept layouts, the need for creative ways to divide space and absorb sound is greater than ever. Introducing HON acoustics by Unika Vaev. We've partnered with one of the most trusted brands in the acoustic industry to bring you several of their most popular models from their standard collection. This partnership will fulfill the growing need for sound absorption in the workplace by providing proven acoustic solutions sold by HON.

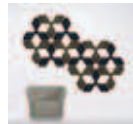

FEATURES

- Choose from wall, ceiling, and freestanding acoustic products.
- Unique shapes and designs allow for a functional and customized space.
- Freestanding and select hanging models allow for a creative way to divide your space.
- Blend in or stand out with multiple finish options.
- Products ship directly from Unika Vaev.
- Follows HON standard freight terms.
- Please see HON.com for care and installation guide.
- **HON 5-Year Limited Warranty.**

UNIVERSAL SCREENS

ACOUSTIC SOLUTIONS ORDERING INFORMATION

| | ecoustic® Felt | Solid Core | Salsa | Dox | Fraster Felt |
|------------------------------|----------------|------------|-------|-----|--------------|
| Wall Mounted Tiles | | | | | |
| e3 Collection | | • | | | |
| ecoustic® Foliar | • | | | | |
| ecoustic® Linear | • | | | | |
| ecoustic® Matrix | • | | | | |
| ecoustic® Torque | • | | | | |
| Ceiling-Mounted Tiles | | | | | |
| ecoustic® Arbor Alto | | • | | | |
| ecoustic® Ceiling Flats | | • | | | |
| ecoustic® Matrix | • | | | | |
| ecoustic® Torque | • | | | | |
| ecoustic® Measure Baffles | | • | | | |
| Hanging Screens | | | | | |
| ScreenTrak® Bass Collection | • | | | | |
| ScreenTrak® Alto | | • | | | |
| Free-standing Screens | | | | | |
| MixMax | | | | | • |
| Softline | | | • | • | |

(02/2020)

ScreenTrak and ecoustic are registered trademarks of Unika Vaev.

ACOUSTIC SOLUTIONS ORDERING INFORMATION

ECOUSTIC*

| | |
|-------------|------|
| Lemon* | EF15 |
| Baltic* | EF36 |
| Nautical** | EF41 |
| Paprika* | EF53 |
| Berry* | EF55 |
| Aqua* | EF62 |
| Field* | EF68 |
| Aubergine* | EF76 |
| Fossil* | EF78 |
| Dove** | EF87 |
| Oyster** | EF88 |
| Quartz* | EF92 |
| Spray** | EF63 |
| Cameo** | EF19 |
| Caper* | EF64 |
| Charcoal* | EF79 |
| Cobalt* | EF35 |
| Cream** | EF94 |
| Fresco** | EF65 |
| Green* | EF67 |
| Indigo* | EF40 |
| Jet* | EF80 |
| Light Grey* | EF81 |
| Lime* | EF66 |
| Natural** | EF95 |
| Oatmeal** | EF89 |
| Opal** | EF93 |
| Orange* | EF52 |
| Pewter* | EF91 |
| Red* | EF54 |
| Yellow* | EF10 |
| White** | EF96 |
| Taupe* | EF90 |
| Sky** | EF39 |

SOLID CORE

| | |
|----------|------|
| Almond | DAL1 |
| Arizona | DAZ1 |
| Bluebell | DBB1 |
| Cool | DCL1 |
| Galaxy | DGX1 |
| Iris | DRS1 |
| Leaf | DLF1 |
| Oxide | DXD1 |
| Snowdrop | DSW1 |
| Tungsten | DTG1 |
| Venus | DVN1 |
| Denim | DDM1 |
| Fawn | DFN1 |
| Horizon | DHN1 |
| Olive | DLV1 |

SALSA

| | |
|---------------|------|
| Light Grey | SL30 |
| Blue | SL31 |
| Dark Mid Grey | DL32 |
| Yellow | SL33 |
| Dark Yellow | SL34 |
| Green | SL35 |
| Mid Grey | SL36 |
| Pink | SL39 |
| Dark Blue | SL40 |
| Light Pink | SL54 |
| Green | SL55 |
| Brown | SL56 |
| Beige | SL57 |

DOX

| | |
|-------------|-------|
| Black | DOX50 |
| Dark Grey | DOX51 |
| Middle Grey | DOX52 |
| Light Grey | DOX53 |

FRASTER FELT

| | |
|------------|-------|
| Red | FF102 |
| Orange | FF105 |
| Ochre | FF130 |
| Wine | FF136 |
| Off White | FF150 |
| Beige | FF160 |
| Silver | FF170 |
| Charcoal | FF175 |
| Beaver | FF190 |
| Deer | FF220 |
| Truffle | FF250 |
| Mint | FF262 |
| Curry | FF274 |
| Azur | FF312 |
| Citrus | FF398 |
| Banana | FF399 |
| Dust Green | FF415 |
| Black | FF426 |
| Aubergine | FF437 |
| Moss | FF448 |
| Sepia | FF463 |
| Tomato | FF484 |
| Flamingo | FF534 |
| Midnight | FF539 |
| Ocean | FF540 |
| Sky | FF541 |

To view these options in the HON Surface Materials Guide visit hon.com/fabrics-and-finishes.







* Applied over Black solid core on ScreenTrak® Bass Hanging Screens.

** Applied over White solid core on ScreenTrak® Bass Hanging Screens.

ACOUSTIC SOLUTIONS

Wall

OPEN MARKET

| | DESCRIPTION | MODEL | SHIP WEIGHT | CUBE | LIST PRICE |
|--|---|---------|-------------|------|------------|
|  | e3 Solid Core Parallelogram 8¾" x 7½" x ½", Box of 15 | HUVPAWT | 5.0 | 0.2 | \$995 |
|  | e3 Solid Core Triangle 8¾" Equilateral Sides, Box of 30 | HUVTRWT | 5.2 | 0.6 | \$995 |
|  | e3 Solid Core Rectangle 8¾" x 17½", Box of 7 | HUVREWT | 5.4 | 1.0 | \$995 |
|  | e3 Solid Core Large Square 8¾" x 8¾", Box of 15 | HUVLSWT | 5.2 | 0.6 | \$946 |
|  | e3 Solid Core Small Square 2¼" x 2¼", Box of 60 | HUVSSWT | 5.2 | 0.6 | \$946 |
|  | e3 Solid Core Wave 17½" x 8½", Box of 8 | HUVVWWT | 5.2 | 0.6 | \$995 |
|  | e3 Solid Core Hexagon 17½" x 15¼", Box of 5 | HUVHEWT | 5.2 | 0.6 | \$995 |



NOTES:

- Tiles sold in sets of individual shapes. Tiles can be arranged and combined to form larger and more intricate shapes. Attaches to wall by adhesive backing that ships already applied to the tiles.

Content: 100% PET (>50% Recycled PET)

Application: Wall

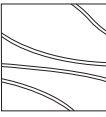
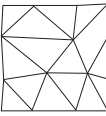
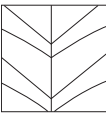
NRC: 0.40

| | DESCRIPTION | MODEL | SHIP WEIGHT | CUBE | LIST PRICE |
|--|---|---------|-------------|------|------------|
|  | Drift ecoustic® Wall Tiles 19¼"W x 19¼"H x 1¼"D, 8 per box NOTES: Attaches via wall clips. Content: 100% PET (>50% Recycled PET) Application: Wall NRC: 0.85 | HUVDRT | 13.2 | 4.3 | \$3212 |
|  | Matrix ecoustic® Wall Tiles 19¼"W x 19¼"H x 1½"D, 8 per box NOTES: Attaches via wall clips. Content: 100% PET (>50% Recycled PET) Application: Wall NRC: 0.90 | HUVMAWT | 13.2 | 4.3 | \$3212 |
|  | Torque ecoustic® Wall Tiles 22½"W x 22½"H x 1½"D, 8 per box NOTES: Attaches via wall clips. Content: 100% PET (>50% Recycled PET) Application: Wall NRC: 0.80 | HUVTOWT | 15.4 | 5.3 | \$3212 |
|  | Foliar ecoustic® Wall Tiles 17½"W x 19¼"H x 2¾"D, 5 per box NOTES: Attachment plastic frame screws to the wall. Content: 100% PET (>50% Recycled PET) Application: Wall NRC: 0.80 | HUVFOWT | 9.0 | 3.0 | \$2596 |

HOW TO SPECIFY

| | |
|--|---|
| <p>Select Model Number</p> <p>H U V D R W T .</p> | <p>Select Material</p> <p>See page 758</p> <p>Specify ecoustic® Felt for Wall Tiles and PET Solid Core for e3 Tiles</p> <p>E F 5 2</p> |
|--|---|

ACOUSTIC SOLUTIONS

Ceiling Tiles and Screens

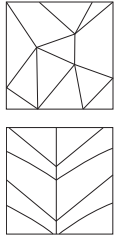

DESCRIPTION

Matrix ecoustic® Ceiling Tiles
 23⁷/₁₆"W x 23³/₁₆"H x 2⁹/₁₆"D, Pack of 8 tiles
 47¹/₁₆"W x 23⁷/₁₆"H x 2⁹/₁₆"D, Pack of 8 tiles

Torque ecoustic® Ceiling Tiles
 23³/₈"W x 23³/₈"H x 1⁷/₈"D, Pack of 8 tiles
 47¹/₁₆"W x 23³/₈"H x 1⁷/₈"D, Pack of 8 tiles

NOTES: Matrix and Torque tile packs contain groups of eight solid colors. Fits directly into 2' x 2' or 2' x 4' drop ceiling grid. Tiles replace ceiling tiles already in the grid. Tiles slide into grid at an angle and are held in by the edge of the tile. No hardware is needed.
 Content: 100% PET (>50% Recycled PET)
 Application: Ceiling
 NRC: 0.80 (Torque), 0.75 (Matrix)

MODEL SHIP WEIGHT CUBE LIST PRICE

HUVMAWT24 15.4 5.3 **\$3277**
HUVMAWT48 30.9 10.7 **\$4932**

HUVTOWT24 15.4 5.3 **\$3277**
HUVTOWT48 30.9 10.7 **\$4932**

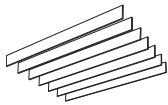

Measure Baffles

47"W x 10³/₄"H
 96"W x 10³/₄"H

NOTES: Ships 4 per box with 4' hanging cords. Attaches via ceiling brackets (not included). Attachment hardware to ceiling should be procured by installers.
 Content: 100% PET
 Application: Ceiling
 NRC: 0.80

HUVMBHS48 15.0 0.8 **\$1258**
HUVMBHS96 30.0 1.6 **\$1580**

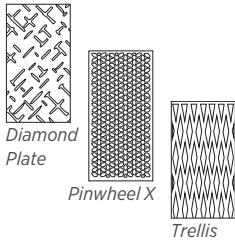

ScreenTrak® Bass Hanging Screen — Felt

95"H x 46"W x 1/2"D, Diamond Plate
 95"H x 46"W x 1/2"D, Pinwheel X
 95"H x 46"W x 1/2"D, Trellis

NOTES: Solid core with felt on top — black or white solid core is automatically assigned to each color. See page 758 for color/felt applications.

HUVSTBHS 17.4 2.7 **\$2587**
HUVSTBHS 17.4 2.7 **\$2587**
HUVSTBHS 17.4 2.7 **\$2587**

ScreenTrak® Alto Hanging Screen — Solid Color Core

95"H x 46"W x 1/2"D, Diamond Plate
 95"H x 46"W x 1/2"D, Pinwheel X
 95"H x 46"W x 1/2"D, Trellis

NOTES: Ships with 10' hanging cords.

⚠ Ceiling attachment is not included due to many ceiling types and materials. Attachment hardware to ceiling should be procured by installers.

Content: 100% PET (>50% Recycled PET)
 Application: Vertical Surfaces/Screens
 NRC: 0.20

HUVSTAHS 17.4 2.7 **\$2305**
HUVSTAHS 17.4 2.7 **\$2305**
HUVSTAHS 17.4 2.7 **\$2305**

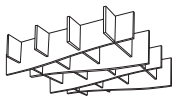

Arbor Alto ecoustic® Hanging Screen — Solid Color Core

48"H x 48"W x 4¹/₄"-7¹/₄"D

NOTES: Kit format contains 8 fins and 4' hanging cords.

⚠ Ceiling attachment is not included due to many ceiling types and materials. Attachment hardware to ceiling should be procured by installers.

Content: 100% PET
 Application: Ceiling
 NRC: 0.80

HUVAAHS 15.0 0.8 **\$1344**



ecoustic® Ceiling Flats

24" x 24", Box of 16
 24" x 48", Box of 8

NOTES: Fits directly into 2' x 2' or 2' x 4' dropped ceiling grid. Flats replace ceiling tiles already in the grid. Tiles slide into grid at an angle and are held in by the edge of the tile. No hardware is needed.

Content: 100% PET (>50% Recycled PET)
 Application: Ceiling
 NRC: 0.85
 Tiles are .47" thick.

HUVCFT24 15.4 5.3 **\$2355**
HUVCFT48 30.9 10.7 **\$2503**

HOW TO SPECIFY

| | |
|---|---|
| <p>Select Model Number</p> <p>H U V S T A H S P</p> | <p>Select Felt/Solid Core</p> <p>See pages 758-759</p> <p>D L F 1</p> |
|---|---|

ACOUSTIC SOLUTIONS

Floor Screens

OPEN MARKET

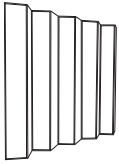

DESCRIPTION

MixMax
55"W x 59"H
63"W x 59"H

MODEL

HUVMF55
HUVMF63

SHIP WEIGHT

19.8
22.7

CUBE

24.4
24.4

LIST PRICE

\$3876
\$4282

NOTES:

- Available in one solid color. For multicolor options contact HON Tailored Solutions.
- Content: 100% 3mm Wool Felt exterior. 100% Foamed PVC Plate interior.
- Application: Floor Screen
- NRC: 0.80

UNIVERSAL SCREENS

HOW TO SPECIFY

Select
Model Number

Select
Fraster Felt

See pages 758-759

H U V M M F S 5 5 .

F F 1 3 0

ACOUSTIC SOLUTIONS Floor Screens

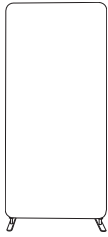

DESCRIPTION

Softline Floor Screen with Leg Set

32"W x 54"H
32"W x 59"H
32"W x 67"H

40"W x 54"H
40"W x 59"H
40"W x 67"H

47"W x 54"H
47"W x 59"H
47"W x 67"H

NOTES: Legs allow for screens to be freestanding.

Softline Floor Screen with Leg Set and Casters

32"W x 54"H
32"W x 59"H
32"W x 67"H

40"W x 54"H
40"W x 59"H
40"W x 67"H

47"W x 54"H
47"W x 59"H
47"W x 67"H

NOTES: Casters allow screens to be mobile.

MODEL

SHIP WEIGHT

CUBE

LIST PRICE

HUVSLFS3254L 25 12.5 **\$1392**
HUVSLFS3259L 30 12.5 **\$1629**
HUVSLFS3267L 35 12.5 **\$1798**

HUVSLFS4054L 27 10.4 **\$1551**
HUVSLFS4059L 33 10.4 **\$1749**
HUVSLFS4067L 38 10.4 **\$1928**

HUVSLFS4754L 30 7.8 **\$1681**
HUVSLFS4759L 36 7.8 **\$1871**
HUVSLFS4767L 43 7.8 **\$2022**

HUVSLFS3254LC 26 12.5 **\$1457**
HUVSLFS3259LC 31 12.5 **\$1692**
HUVSLFS3267LC 36 12.5 **\$1863**

HUVSLFS4054LC 28 10.4 **\$1616**
HUVSLFS4059LC 34 10.4 **\$1813**
HUVSLFS4067LC 39 10.4 **\$1992**

HUVSLFS4754LC 31 7.8 **\$1745**
HUVSLFS4759LC 37 7.8 **\$1936**
HUVSLFS4767LC 44 7.8 **\$2087**

NOTES:

- Softline is manufactured on the basis of technical, environmental, and production ethical requirements. There are no emissions to air, water, or land during the production of Softline. The sound-absorbent core of Softline contains recycled materials. Materials in Softline screens are recyclable, either as material recycling or energy recovery.
- Softline screens are 2" thick.
- Core Content: 100% Mineral Wool
- Frame Content: 100% Pine
- Base Content: 100% Steel lacquered in Black, Gray, or White
- Application: Floor Screen
- NRC: 0.75
- Each screen ships with one in-line connector.
- Screen legs prohibit screens from sitting directly at an L-, T-, or X-connection. Space must be provided to prevent legs from overlapping.

UNIVERSAL SCREENS

HOW TO SPECIFY

| | | |
|--|--|--|
| <p>Select Model Number</p> <p>H U V S L F S 4 0 5 4 L</p> | <p>Select Fabric</p> <p>See page 759</p> <p>S L 4 0</p> | <p>Select Paint Color</p> <p><i>Specify on screens with legs and legs with casters only</i></p> <p>SVR Silver WHTT White Texture BLKT Black Texture</p> <p>W H T T</p> |
|--|--|--|

DESKTOP SCREENS ORDERING INFORMATION

DESKTOP PET

| PET | CODES |
|---------------|-------------|
| ◆ Dark Blue | DDB1 |
| ◆ Green | DGN1 |
| ◆ Dark Gray | DGY4 |
| ◆ Medium Gray | DGY3 |

EMPOWER® SCREEN BRACKETS

| PAINTS | CODES |
|----------------------|-------------|
| P1 | |
| ◆ Black | P71 |
| ◆ Brownstone | P7D |
| ◆ Charcoal | S |
| ◆ Designer White | PJW |
| ◆ Fossil | P28 |
| ◆ Greige | T5 |
| ◆ Light Gray | Q |
| ◆ Loft | LOFT |
| ◆ Muslin | T3 |
| ◆ Putty | L |
| ◆ Shadow * | SHDW |
| ◆ Titanium | P8T |
| P2 | |
| ◆ Champagne Metallic | T4 |
| ◆ Platinum Metallic | T1 |
| ◆ Silver | PR6 |
| ◆ Solar Black | P8X |
| P3 | |
| ◆ Atom | P8S |
| ◆ Bullseye | PJF |
| ◆ Ember | P8P |
| ◆ Ion | P8N |
| ◆ Iris | P8J |
| ◆ Krypton | P8F |
| ◆ Regatta | P8M |

GRAVITATION™ SCREEN BRACKETS

| PAINTS | CODES |
|----------------------|-------------|
| P1 | |
| ◆ Black | P71 |
| ◆ Brownstone | P7D |
| ◆ Charcoal | P02 |
| ◆ Designer White | PJW |
| ◆ Fossil | P28 |
| ◆ Greige | T5 |
| ◆ Light Gray | Q |
| ◆ Loft | LOFT |
| ◆ Muslin | T3 |
| ◆ Putty | L |
| ◆ Shadow * | SHDW |
| ◆ Titanium | P8T |
| P2 | |
| ◆ Champagne Metallic | T4 |
| ◆ Silver | PR6 |
| ◆ Solar Black | P8X |
| P3 | |
| ◆ Atom | P8S |
| ◆ Bullseye | PJF |
| ◆ Ember | P8P |
| ◆ Ion | P8N |
| ◆ Iris | P8J |
| ◆ Krypton | P8F |
| ◆ Regatta | P8M |

◆◆◆ For lead time information see page 19.

* De-emphasized

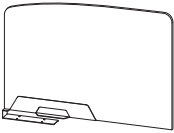
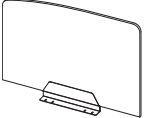
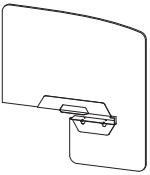
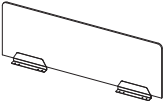
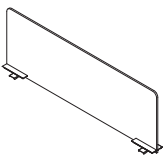

DESKTOP SCREENS

| | DESCRIPTION | MODEL | SHIP WEIGHT | CUBE | LIST PRICE |
|--|---|---------------|-------------|------|------------|
|  | Coordinate™ Side/Middle Desktop PET Screens 23¼"W x 13"H 29¼"W x 13"H | HUVDSSM1324 | 3.0 | 1.5 | \$214 |
| | | HUVDSSM1330 | 3.3 | 1.8 | \$252 |
| | 23¼"W x 20"H 29¼"W x 20"H | HUVDSSM2024 | 3.6 | 2.3 | \$252 |
| | | HUVDSSM2030 | 4.1 | 2.7 | \$296 |
|  | Coordinate™ Side/End Desktop PET Screens 23¼"W x 13"H 29¼"W x 13"H | HUVDSSE1324 | 3.0 | 1.5 | \$239 |
| | | HUVDSSE1330 | 3.0 | 1.8 | \$278 |
| | 23¼"W x 20"H 29¼"W x 20"H | HUVDSSE2024 | 3.5 | 2.3 | \$278 |
| | | HUVDSSE2030 | 4.1 | 2.7 | \$315 |
| NOTES: Screen attachment method involves screwing into the underside of the worksurface. | | | | | |
|  | Coordinate™ Pacman PET Screens 23¼"W x 13"H, for 23"D Surfaces 29¼"W x 13"H, for 29"D Surfaces | HUVDPS1324 | 5.7 | 1.8 | \$285 |
| | | HUVDPS1330 | 6.2 | 2.1 | \$335 |
| | 23¼"W x 20"H, for 23"D Surfaces 29¼"W x 20"H, for 29"D Surfaces | HUVDPS2024 | 6.3 | 2.7 | \$335 |
| | | HUVDPS2030 | 7.0 | 3.2 | \$394 |
| NOTES: Screen extends 6" from front of surface and 9" below surface. | | | | | |
|  | Coordinate™ Above Desktop PET Screens 46"W x 13"H 58"W x 13"H 70"W x 13"H | HUVDSAO1348 | 5.0 | 2.7 | \$401 |
| | | HUVDSAO1360 | 5.6 | 3.3 | \$445 |
| | | HUVDSAO1372 | 6.2 | 4.0 | \$494 |
| | 46"W x 20"H 58"W x 20"H 70"W x 20"H | HUVDSAO2048 | 6.2 | 4.1 | \$501 |
| | | HUVDSAO2060 | 7.1 | 5.0 | \$556 |
| | | HUVDSAO2072 | 8.0 | 5.9 | \$617 |
| NOTES: Screen attachment method involves screwing into the underside of the worksurface. Brackets can be positioned as needed to clear worksurface supports. | | | | | |
|  | Empower® Desktop Screens 46"W x 13"H 58"W x 13"H 70"W x 13"H | HUVDSAOEM1348 | 5.0 | 2.7 | \$511 |
| | | HUVDSAOEM1360 | 5.6 | 3.3 | \$555 |
| | | HUVDSAOEM1372 | 6.2 | 4.0 | \$605 |
| | 46"W x 20"H 58"W x 20"H 70"W x 20"H | HUVDSAOEM2048 | 6.2 | 4.1 | \$611 |
| | | HUVDSAOEM2060 | 7.1 | 5.0 | \$666 |
| | | HUVDSAOEM2072 | 8.0 | 5.9 | \$728 |
| NOTES: Specify PET and Bracket Paint, see page 764. P2 upcharge + \$4, P3 upcharge + \$20. Brackets can be positioned as needed to clear worksurface supports. | | | | | |

NOTES:

- PET material is 12mm thick.
- Brackets painted in PR8 Silver.
- Brackets and screens ship in same box.
- PET material is tackable.

HOW TO SPECIFY

| | | |
|---|--|--|
| <p>Select Model Number</p> <p>H U V D S S M 1 3 3 0 .</p> | <p>Select PET Desktop</p> <p>See page 764</p> <p>D G Y 3 .</p> | <p>Select Paint Color</p> <p>PR6 Silver</p> <p>P R 6</p> |
|---|--|--|

DESKTOP SCREENS

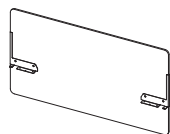

DESCRIPTION

Coordinate™ Above/Below PET Screens

46"W x 32"H, 13"H Above
58"W x 32"H, 13"H Above
70"W x 32"H, 13"H Above

46"W x 32"H, 20"H Above
58"W x 32"H, 20"H Above
70"W x 32"H, 20"H Above

NOTES: Screen attachment method involves screwing into the underside of the worksurface.

MODEL

SHIP WEIGHT

CUBE

LIST PRICE

| | | | |
|--------------|-------|-----|-------|
| HUVDSHAB4813 | 9.7 Ⓢ | 6.3 | \$766 |
| HUVDSHAB6013 | 11.0 | 7.7 | \$851 |
| HUVDSHAB7213 | 12.8 | 9.1 | \$945 |
| HUVDSHAB4820 | 9.7 Ⓢ | 6.3 | \$766 |
| HUVDSHAB6020 | 11.0 | 7.7 | \$851 |
| HUVDSHAB7220 | 12.8 | 9.1 | \$945 |

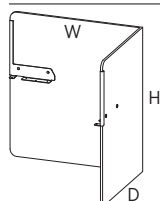

Coordinate™ Above/Below "L" PET Screens

23¼"D x 23"W x 32"H, 13"H Above, Right Hand
23¼"D x 29"W x 32"H, 13"H Above, Right Hand
23¼"D x 35"W x 32"H, 13"H Above, Right Hand

29¼"D x 23"W x 32"H, 20"H Above, Right Hand
29¼"D x 29"W x 32"H, 20"H Above, Right Hand
29¼"D x 35"W x 32"H, 20"H Above, Right Hand

23¼"D x 23"W x 32"H, 13"H Above, Left Hand
23¼"D x 29"W x 32"H, 13"H Above, Left Hand
23¼"D x 35"W x 32"H, 13"H Above, Left Hand

29¼"D x 23"W x 32"H, 20"H Above, Left Hand
29¼"D x 29"W x 32"H, 20"H Above, Left Hand
29¼"D x 35"W x 32"H, 20"H Above, Left Hand

NOTES: Screen attachment method includes screwing into the underside of the worksurface.

| | | | |
|--------------|------|-----|--------|
| HUVABLS2424R | 9.2 | 6.3 | \$880 |
| HUVABLS3024R | 9.9 | 7.0 | \$929 |
| HUVABLS3624R | 9.9 | 7.7 | \$978 |
| HUVABLS2430R | 10.6 | 6.3 | \$1068 |
| HUVABLS3030R | 10.6 | 7.0 | \$1124 |
| HUVABLS3630R | 10.6 | 7.7 | \$1228 |
| HUVABLS2424L | 9.2 | 6.3 | \$880 |
| HUVABLS3024L | 9.9 | 7.0 | \$929 |
| HUVABLS3624L | 9.9 | 7.7 | \$978 |
| HUVABLS2430L | 10.6 | 6.3 | \$1068 |
| HUVABLS3030L | 10.6 | 7.0 | \$1124 |
| HUVABLS3630L | 10.6 | 7.7 | \$1228 |

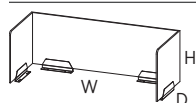

Coordinate™ Above "U" PET Screens

23¼"D x 46"W x 13"H
23¼"D x 58"W x 13"H
23¼"D x 70"W x 13"H

23¼"D x 46"W x 20"H
23¼"D x 58"W x 20"H
23¼"D x 70"W x 20"H

29¼"D x 46"W x 13"H
29¼"D x 58"W x 13"H
29¼"D x 70"W x 13"H

29¼"D x 46"W x 20"H
29¼"D x 58"W x 20"H
29¼"D x 70"W x 20"H

NOTES: Screen attachment method involves screwing into the underside of the worksurface.

Ⓢ Screens are for use with Coordinate™ and Empower® Height Adjustable.

| | | | |
|--------------|------|-----|--------|
| HUVAUS482413 | 12.0 | 4.0 | \$988 |
| HUVAUS602413 | 12.6 | 4.6 | \$1039 |
| HUVAUS722413 | 13.2 | 5.2 | \$1095 |
| HUVAUS482420 | 14.5 | 5.9 | \$1235 |
| HUVAUS602420 | 15.4 | 6.8 | \$1299 |
| HUVAUS722420 | 16.3 | 7.7 | \$1370 |
| HUVAUS483013 | 12.6 | 4.0 | \$1082 |
| HUVAUS603013 | 13.2 | 4.6 | \$1133 |
| HUVAUS723013 | 13.7 | 5.2 | \$1189 |
| HUVAUS483020 | 15.4 | 5.9 | \$1351 |
| HUVAUS603020 | 16.3 | 6.8 | \$1415 |
| HUVAUS723020 | 17.1 | 7.7 | \$1486 |

UNIVERSAL SCREENS

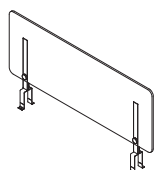

DESCRIPTION

Gravitation™ Beam PET Screen

46"W x 20"H
58"W x 20"H
70"W x 20"H

NOTES: Specify PET and Bracket Paint, see page 764. Brackets and screen ship in separate boxes.

MODEL

SHIP WEIGHT

CUBE

LIST PRICE BY PAINT GRADE

P1

P2

P3

| | | | | | |
|-------------|-------|-----|-------|-------|-------|
| HUVDSBS2048 | 3.5 Ⓢ | 4.1 | \$621 | \$625 | \$641 |
| HUVDSBS2060 | 4.4 Ⓢ | 5.0 | \$679 | \$683 | \$699 |
| HUVDSBS2072 | 5.3 Ⓢ | 5.9 | \$842 | \$846 | \$862 |

NOTES:

- PET material is 12mm thick.
- Brackets painted in PR8 Silver.
- Brackets and screens ship in same box except for Gravitation™ Beam PET Screens.
- PET material is tackable.

HOW TO SPECIFY

| | | |
|---|--|--|
| <p>Select Model Number</p> <p>H U V D S H A B 6 0 1 3 .</p> | <p>Select PET Desktop</p> <p>See page 764</p> <p>D G Y 3 .</p> | <p>Select Paint Color</p> <p>PR6 Silver</p> <p>P R 6</p> |
|---|--|--|

UNIVERSAL SCREENS ORDERING INFORMATION

METAL TABLE SCREENS AND BRACKETS

PAINTS CODES

P1

| | |
|------------------------|------|
| ◆ Black | P71 |
| ◆ Brownstone | P7D |
| ◆ Charcoal | P02 |
| ◆ Designer White | PJW |
| ◆ Fossil | P28 |
| ◆ Greige | T5 |
| ◆ Light Grey | Q |
| ◆ Loft | LOFT |
| ◆ Muslin | T3 |
| ◆ Putty | L |
| ◆ Shadow * | SHDW |
| ◆ Titanium | P8T |

P2

| | |
|----------------------------|-----|
| ◆ Champagne Metallic | T4 |
| ◆ Platinum Metallic | T1 |
| ◆ Silver | PR6 |
| ◆ Solar Black | P8X |

P3

| | |
|---------------------|------|
| ◆ Amethyst | P091 |
| ◆ Atom | P8S |
| ◆ Blossom | P8K |
| ◆ Bullseye | PJF |
| ◆ Cabernet * | P7T |
| ◆ Cobalt Mica | P090 |
| ◆ Conifer * | P8H |
| ◆ Ember | P8P |
| ◆ Ion | P8N |
| ◆ Iris | P8J |
| ◆ Krypton | P8F |
| ◆ Ochre | P093 |
| ◆ Regatta | P8M |
| ◆ Sienna | P092 |
| ◆ Succulent | P8A |

P6

| | |
|---------------------|-----|
| ◆ Markerboard | MKB |
|---------------------|-----|

* De-emphasized



UNIVERSAL SCREENS

Table Screens

OPEN MARKET

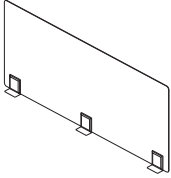
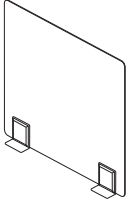

Icon Legend on page 19

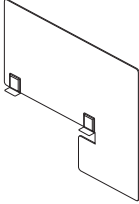
| | DESCRIPTION | MODEL | SHIP WEIGHT | CUBE | LIST PRICE BY PAINT GRADE | | | |
|---|--|---|-------------|------|---------------------------|--------------|--------------|--------------|
| | | | | | P1 | P2 | P3 | P6 |
|  | Metal Table Screen | | | | | | | |
| | 20"H x 45½"W, for 48"W Surfaces | HMTLSCRN2048 | 36.4 | 5.5 | \$684 | \$704 | \$724 | \$784 |
| | 20"H x 51½"W, for 54"W Surfaces | HMTLSCRN2054 | 39.7 | 6.1 | \$718 | \$738 | \$758 | \$818 |
| | 20"H x 57½"W, for 60"W Surfaces | HMTLSCRN2060 | 43.1 | 6.7 | \$755 | \$775 | \$795 | \$855 |
| | 20"H x 63½"W, for 66"W Surfaces | HMTLSCRN2066 | 46.4 | 7.3 | \$792 | \$812 | \$832 | \$892 |
| | 25"H x 45½"W, for 48"W Surfaces | HMTLSCRN2548 | 42.8 | 6.7 | \$752 | \$772 | \$792 | \$852 |
| | 25"H x 51½"W, for 54"W Surfaces | HMTLSCRN2554 | 46.9 | 7.4 | \$790 | \$810 | \$830 | \$890 |
| | 25"H x 57½"W, for 60"W Surfaces | HMTLSCRN2560 | 51.1 | 8.2 | \$829 | \$849 | \$869 | \$929 |
| | 25"H x 63½"W, for 66"W Surfaces | HMTLSCRN2566 | 55.3 | 9.0 | \$871 | \$891 | \$911 | \$971 |
| |  | Metal Lateral Screen | | | | | | |
| 20"H x 21"D, for 24"D Surfaces | | HMTLSCRN2024 | 19.5 | 3.0 | \$473 | \$493 | \$513 | \$573 |
| 20"H x 25"D, for 27"-30"D Surfaces | | HMTLSCRN2030 | 21.6 | 3.4 | \$497 | \$517 | \$537 | \$597 |
| 20"H x 36"D, for 36"D Surfaces | | HMTLSCRN2036 | 26.6 | 4.3 | \$521 | \$541 | \$561 | \$621 |
| 25"H x 21"D, for 24"D Surfaces | | HMTLSCRN2524 | 22.4 | 3.7 | \$520 | \$540 | \$560 | \$620 |
| 25"H x 25"D, for 30"D Surfaces | | HMTLSCRN2530 | 25.0 | 4.2 | \$547 | \$567 | \$587 | \$647 |
| 25"H x 34"D, for 36"D Surfaces | | HMTLSCRN2536  | 31.3 | 5.3 | \$575 | \$595 | \$615 | \$675 |
|  | Metal Extended Screen | | | | | | | |
| | 20"H x 33½"D, for 24"D Surfaces | HMTLEXSCRN2036 | 61.2 | 5.7 | \$629 | \$649 | \$669 | \$729 |
| | 20"H x 37"D, for 30"D Surfaces | HMTLEXSCRN2042 | 65.9 | 6.3 | \$661 | \$681 | \$701 | \$761 |
| | 25"H x 33½"D, for 24"D Surfaces | HMTLEXSCRN2536 | 71.6 | 6.6 | \$693 | \$713 | \$733 | \$793 |
| | 25"H x 37"D, for 30"D Surfaces | HMTLEXSCRN2542 | 77.4 | 7.3 | \$727 | \$747 | \$767 | \$827 |

NOTES:

- Metal screens are single-piece steel construction.
- Screens mount by using double stick tape, which provides the ability to mount to any surface.
- Extended Screen can be used on all HON products including Voi®, Empower®, and Coordinate™ Height Adjustable Tables. Extended screen can also be used on any 2½" thick or under surface with 5"D clear space underneath.
- Minimum mounting clearance on top of worksurface at each bracket location is 3"W x 1½"D.

HOW TO SPECIFY

| | | |
|--|--|--|
| <p>Select Model Number</p> <p>HMTLSCRN2054</p> | <p>Select Frame Paint</p> <p>See page 767</p> <p>P8T</p> | <p>Select Bracket Paint</p> <p>NA No Specification Needed, matches Frame Paint</p> <p>NA</p> |
|--|--|--|



UNIVERSAL SCREENS

Table Screens

| | DESCRIPTION | MODEL | SHIP WEIGHT | CUBE | LIST PRICE BY PAINT GRADE | | | |
|------------------------------------|---------------------------------|-------------------------------|-------------|------|---------------------------|-------|-------|-----|
| | | | | | P1 | P2 | P3 | P6 |
| | Acrylic Table Screen | | | | | | | |
| | 20"H x 45½"W, for 48"W Surfaces | HACRYSCRN2048 | 8.0 | 5.5 | \$616 | \$628 | \$634 | N/A |
| | 20"H x 51½"W, for 54"W Surfaces | HACRYSCRN2054 | 12.0 | 6.1 | \$647 | \$659 | \$665 | N/A |
| | 20"H x 57½"W, for 60"W Surfaces | HACRYSCRN2060 | 14.0 | 6.7 | \$679 | \$691 | \$697 | N/A |
| | 20"H x 63½"W, for 66"W Surfaces | HACRYSCRN2066 | 15.0 | 7.3 | \$713 | \$725 | \$731 | N/A |
| | 25"H x 45½"W, for 48"W Surfaces | HACRYSCRN2548 ☹ | 15.0 | 6.7 | \$678 | \$690 | \$696 | N/A |
| | 25"H x 51½"W, for 54"W Surfaces | HACRYSCRN2554 ☹ | 18.0 | 7.4 | \$711 | \$723 | \$729 | N/A |
| | 25"H x 57½"W, for 60"W Surfaces | HACRYSCRN2560 ☹ | 20.0 | 8.2 | \$747 | \$759 | \$765 | N/A |
| | 25"H x 63½"W, for 66"W Surfaces | HACRYSCRN2566 ☹ | 21.0 | 9.0 | \$784 | \$796 | \$802 | N/A |
| | | Acrylic Lateral Screen | | | | | | |
| 20"H x 21"D, for 24"D Surfaces | | HACRYSCRN2024 | 5.0 | 3.0 | \$426 | \$434 | \$438 | N/A |
| 20"H x 25"D, for 27"-30"D Surfaces | | HACRYSCRN2030 | 5.0 | 3.4 | \$448 | \$456 | \$460 | N/A |
| 20"H x 36"D, for 36"D Surfaces | | HACRYSCRN2036 | 6.0 | 4.3 | \$470 | \$478 | \$482 | N/A |
| 25"H x 21"D, for 24"D Surfaces | | HACRYSCRN2524 ☹ | 6.0 | 3.7 | \$469 | \$477 | \$481 | N/A |
| 25"H x 25"D, for 30"D Surfaces | | HACRYSCRN2530 ☹ | 8.0 | 4.2 | \$491 | \$499 | \$503 | N/A |
| 25"H x 34"D, for 36"D Surfaces | | HACRYSCRN2536 ☹ | 11.0 | 5.3 | \$516 | \$524 | \$528 | N/A |
| | Acrylic Extended Screen | | | | | | | |
| | 20"H x 33½"D, for 24"D Surfaces | HACRYEXSCRN2036 | 7.0 | 5.7 | \$568 | \$576 | \$580 | N/A |
| | 20"H x 37"D, for 30"D Surfaces | HACRYEXSCRN2042 ☹ | 9.0 | 6.3 | \$595 | \$603 | \$607 | N/A |
| | 25"H x 33½"D, for 24"D Surfaces | HACRYEXSCRN2536 | 12.0 | 6.6 | \$623 | \$631 | \$635 | N/A |
| | 25"H x 37"D, for 30"D Surfaces | HACRYEXSCRN2542 | 14.0 | 7.3 | \$655 | \$663 | \$667 | N/A |

NOTES:

- Screens mount by using double stick tape, which provides the ability to mount to any surface.
- Extended Screen can be used on all HON products including Voi®, Empower®, and Coordinate™ Height Adjustable Tables. Extended screen can also be used on any 2½" thick or under surface with 5"D clear space underneath.
- Minimum mounting clearance on top of worksurface at each bracket location is 3"W x 1½"D.

HOW TO SPECIFY

| | |
|---|--|
| <p>Select Model Number</p> <p>H A C R Y S C R N 2 0 5 4 .</p> | <p>Select Bracket Paint</p> <p>See page 767</p> <p>P 8 T</p> |
|---|--|

UNIVERSAL SCREENS

Plexi-Glass Screens

OPEN MARKET



Icon Legend on page 19

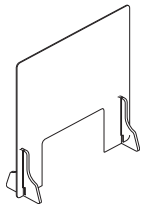

DESCRIPTION

Plexi-Glass Screens with Pass-Thru Opening

36''H x 30''W
36''H x 36''W
36''H x 48''W

MODEL

HHC-TASCRN3630 ⓘ
HHC-TASCRN3636 ⓘ
HHC-TASCRN3648

SHIP WEIGHT

13
15
19

CUBE

1.4
1.1
1.5

LIST PRICE

\$494
\$505
\$516

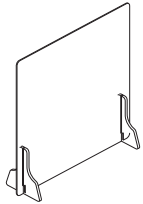

Plexi-Glass Screens without Pass-Thru Opening

24''H x 30''W
24''H x 36''W
24''H x 48''W

H-TASCRN2430
H-TASCRN2436
H-TASCRN2448

10
11
14

1.0
1.2
1.6

\$443
\$451
\$469

36''H x 30''W
36''H x 36''W
36''H x 48''W

H-TASCRN3630 ⓘ
H-TASCRN3636 ⓘ
H-TASCRN3648

13
15
19

1.4
1.1
1.5

\$494
\$505
\$516

NOTES:

- Screens ship with two black stands each.
- Screen stand is 11''D x 12''H.
- Pass-thru opening is 20''W x 12''H.

- ! Easy to assemble, no tools required.
- ! Unit is freestanding and does not need to be fixed to any surface.

UNIVERSAL SCREENS



HOW TO SPECIFY

Select
Model Number

HHC-TASCRN3636



UNIVERSAL SCREENS Floor Screens

| | DESCRIPTION | MODEL | SHIP WEIGHT | CUBE | LIST PRICE BY PAINT GRADE | | |
|---|---|------------------------|-------------|------|---------------------------|---------------|---------------|
| | | | | | P1 | P2 | P3 |
|  | Freestanding Acrylic Floor Screens | | | | | | |
| | 60"H x 36"W | HFHACRYSCRN6036 | 55 | 6.1 | \$1090 | \$1106 | \$1114 |
| | 60"H x 48"W | HFHACRYSCRN6048 | 60 | 8.0 | \$1211 | \$1227 | \$1235 |
| | 72"H x 36"W | HFHACRYSCRN7236 | 62 | 7.4 | \$1195 | \$1211 | \$1219 |
| | 72"H x 48"W | HFHACRYSCRN7248 | 65 | 9.6 | \$1327 | \$1343 | \$1351 |
|  | Freestanding Twin-wall Polycarbonate Floor Screens | | | | | | |
| | 60"H x 48"W | HFHPCSCRN6048 | 62 | 8.0 | \$909 | \$925 | \$933 |
| | 72"H x 48"W | HFHPCSCRN7248 | 65 | 9.6 | \$992 | \$1008 | \$1016 |

NOTES:

- Screens ship in single cartons.
- Adjustable glides included.
- ! Screens are not made to accept casters.
- ! Twin-wall Polycarbonate is partially opaque, acrylic is clear.

HOW TO SPECIFY

| | |
|---|--|
| <p>Select Model Number</p> <p>HFHACRYSCRN6048 .</p> | <p>Select Paint Color</p> <p>See page 767</p> <p>PR6</p> |
|---|--|

UNIVERSAL SCREENS

Panel Stackers

OPEN MARKET



Icon Legend on page 19

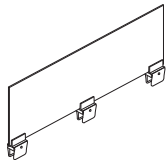

DESCRIPTION

Universal Panel Stackers

15"H x 22"W
15"H x 28"W
15"H x 34"W
15"H x 40"W
15"H x 46"W
15"H x 52"W
15"H x 58"W
15"H x 64"W
15"H x 70"W
15"H x 76"W
15"H x 82"W
15"H x 88"W
15"H x 94"W

MODEL

HPNLSTACK1524
HPNLSTACK1530
HPNLSTACK1536
HPNLSTACK1542
HPNLSTACK1548
HPNLSTACK1554
HPNLSTACK1560
HPNLSTACK1566
HPNLSTACK1572
HPNLSTACK1578
HPNLSTACK1584
HPNLSTACK1590
HPNLSTACK1596

SHIP WEIGHT

CUBE

LIST PRICE BY PAINT GRADE

P1

P2

P3

13.0 1.5 \$380 \$388 \$392
15.0 1.8 \$423 \$431 \$435
17.0 2.1 \$474 \$482 \$486
19.0 2.5 \$524 \$536 \$542
21.0 2.8 \$586 \$598 \$604
24.0 3.2 \$613 \$625 \$631
27.0 3.5 \$634 \$646 \$652
29.0 3.9 \$735 \$751 \$759
31.0 4.2 \$779 \$795 \$803
34.0 4.6 \$824 \$840 \$848
36.0 4.9 \$868 \$884 \$892
38.0 5.3 \$946 \$966 \$976
40.0 5.6 \$1007 \$1027 \$1037

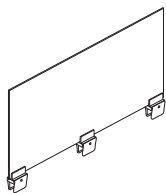

22"H x 22"W
22"H x 28"W
22"H x 34"W
22"H x 40"W
22"H x 46"W
22"H x 52"W
22"H x 58"W
22"H x 64"W
22"H x 70"W
22"H x 76"W
22"H x 82"W
22"H x 88"W
22"H x 94"W

HPNLSTACK2224 Ⓞ
HPNLSTACK2230 Ⓞ
HPNLSTACK2236 Ⓞ
HPNLSTACK2242 Ⓞ
HPNLSTACK2248 Ⓞ
HPNLSTACK2254 Ⓞ
HPNLSTACK2260 Ⓞ
HPNLSTACK2266
HPNLSTACK2272
HPNLSTACK2278
HPNLSTACK2284
HPNLSTACK2290
HPNLSTACK2296

17.0 1.9 \$428 \$436 \$440
20.0 2.4 \$479 \$487 \$491
23.0 2.9 \$535 \$543 \$547
26.0 3.3 \$592 \$604 \$610
29.0 3.8 \$660 \$672 \$678
32.0 4.3 \$693 \$705 \$711
35.0 4.7 \$717 \$729 \$735
38.0 5.2 \$830 \$846 \$854
41.0 5.6 \$880 \$896 \$904
44.0 6.1 \$931 \$947 \$955
47.0 6.6 \$980 \$996 \$1004
50.0 7.0 \$1069 \$1089 \$1099
53.0 7.5 \$1139 \$1159 \$1169

Universal Panel Stacker Bracket 1-Pack

HPNLSTACKBKT

2.5 Ⓞ

1.0

\$135

\$139

\$141

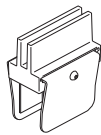

NOTES:

- Can be used on any panel system between 1.975" and 3.450" thick.
- Glass is undersized by 2".
- Stackers can span multiple panels.
- Panel stackers will work with both flat trim and radius trim.
- 1" gap between top cap and bottom of bracket.
- 6mm tempered glass.
- Cannot be used on top of glass stackers.

HOW TO SPECIFY

| | | |
|---|--------------------------------|--------------------------------|
| Select Model Number HPNLSTACK2230 | Select Glass G Glass | Select Paint Color P |
| Select Model Number HPNLSTACKBKT | Select Paint Color P | |



CORE REMOVABLE LOCK KITS

| | DESCRIPTION | MODEL | SHIP WEIGHT | CUBE | LIST PRICE |
|-----------------|--|----------------|-------------|--------------|--------------|
| SIN 33721 | Chrome Removable Lock Core Kit (for metal casegoods) • Use when specifying omit lock application. <ul style="list-style-type: none"> Specify quantity of each key number from 101E-225E. Includes: 1-core, 2-keys, 1-core removal tool and instructions. Removable lock core kits with specific key number must be ordered to facilitate keying alike in the field. For specific models, look for the Omit Lock Core icon throughout this publication. NOTES: If key number isn't specified, number will be at random. Core matches manufactured lock on metal casegoods product but can be used with Contain® and laminate product. | HF23C | 0.1 | 0.1 | \$49 |
| SIN 33721 | Satin Removable Lock Core Kit (for metal and laminate casegoods) • Use when specifying omit lock application. <ul style="list-style-type: none"> Specify quantity of each key number from 101E-225E. Includes: 1-core, 2-keys, 1-core removal tool and instructions. Removable lock core kits with specific key number must be ordered to facilitate keying alike in the field. For specific models, look for the Omit Lock Core icon throughout this publication. NOTES: If key number isn't specified, number will be at random. Core matches manufactured lock on metal casegoods product but can be used with metal casegoods and laminate product. For laminate stack-on and wall mounted storage models with locks, use HF27S. | HF23S | 0.1 | 0.1 | \$47 |
| SIN 33721 | Black Removable Lock Core Kit (for laminate products) Specify quantity of each key number from 101E-225E. Includes: 1-core, 2-keys, 1-core removal tool, and instructions. NOTES: If key number isn't specified, number will be at random. Core matches manufactured lock on laminate product but can be used with metal casegoods product. For laminate stack-on and wall mounted storage models with locks, use HF27B. | HF23B | 0.1 | 0.1 | \$35 |
| OPEN MARKET | Removable Lock Core Kit Black Satin <ul style="list-style-type: none"> For stack-on and wall mounted storage laminate models (with locks) in 10500, 10700, Valido, Voi, Concinnity, and 94000 Series. Specify quantity of each key number from 101E to 225E. Includes: 1-core, 2-keys, 1-core removal tool, and instructions. NOTES: If key number isn't specified, number will be at random. | HF27B HF27S | 0.2 0.2 | 0.02 0.02 | \$35 \$35 |
| OPEN MARKET | Master Key (one key) Will open all HON product with HON "One Key" interchangeable core removable locks. Available to authorized dealers only. Will open HF23B, HF23C, HF23S, HF24, HF27B, and HF27S locks numbered 101E-225E. Will open old HON style MB series locks. | HF22 | 0.1 | 0.1 | \$30 |
| OPEN MARKET | Chrome Core Removable Lock Kit for Vertical Files Field Installable. Specify key number from 101E-225E. Includes: 1-lock with core, 2-keys and attaching linkage. NOTES: If key number isn't specified, number will be at random. | HF24 | 0.2 | 0.2 | \$67 |
| OPEN MARKET | Bulk Package 6 HF24 Lock Kits (Individually shrink wrapped) NOTES: Bulk Package key numbers are at random and cannot be specified. | HF246 | 1.2 | 0.2 | \$310 |

NOTES:

- HON "One Key" interchangeable core removable locks are standard on most HON products. Look for the HON "One Key" icon.
- Keyed alike cores are listed above.
- If key number is not specified, number will be at random.
- For keyed alike locks:
 - Order standard product which will be shipped with factory installed locks and random numbered cores or omit lock option where offered.
 - Order the appropriate quantity of like numbered cores required for each workstation or keyed area.
 - Simply replace the factory installed cores with the replacement cores after product has been installed.
- To install new core:
 - Lock must be in the unlocked position.
 - Insert core removal key and pull core straight out.
 - Insert new core with core removable key, hold core into lock and withdraw core removal key.
 - Retain original core for future use.
- To provide normal lead times, key numbers cannot be specified on HON products at time of order. This also eliminates need for tagging and tracking each product's lock number during installation.
- Black removable lock core kit used on laminate casegoods.
- Chrome removable lock core kit used on metal casegoods.



HOW TO ORDER CORE REMOVABLE LOCK KITS:

Specify: Model Number.X
Key Number
Examples: HF23C.X121E
HF23C.X (Key number not specified)

NOTES: Key orders without numbers specified will be keyed at random.
Numbers 101E-225E are available.

SAMPLE ORDER:

| Quantity | Model | Key Code |
|----------|--------|----------|
| 6 | HF23C. | X121E |
| 4 | HF23B. | X121E |
| 5 | HF24. | X121E |
| 1 | HF22. | X |
| 2 | HF24. | X |



Icon Legend on page 19

TOUCH-UP PAINT

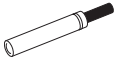

DESCRIPTION

MODEL

SHIP WEIGHT

CUBE

LIST PRICE BY PAINT GRADE

P1

P2

P3

1 Touch-up Paint (.6 oz.)

HPMARKER1

0.1

0.1

\$40

\$47

\$58

NOTES: Touch-up Paint available in P1, P2, and P3 colors.

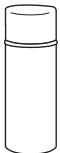

Spray Paint (12 oz.)

HSPRAY

0.5

0.1

\$40

\$47

\$58

NOTES: Touch-up Paint available in P1, P2, and P3 colors.

! Designer White Texture (PK7) for use with Solve base only.

NOTES:

- Allows minor repairs in the field.
- Shippable by small package carrier, ground only.
- Must specify color when ordering.

HOW TO SPECIFY

Select Model Number

Select Color

See page 156 in the 2021 Shared Spaces Pricer

HPMARKER1 . P

CROSS REFERENCE INDEX

| MODEL | PAGE | MODEL | PAGE | MODEL | PAGE | MODEL | PAGE |
|--------------|---------------|-----------|----------|----------|---------------|-----------|----------|
| H-TASCRN2430 | 770 | H10530LEP | 280 | H10543 | 297 | H105729 | 317 |
| H-TASCRN2436 | 770 | H10530TEP | 280 | H10544 | 297 | H10573 | 296 |
| H-TASCRN2448 | 770 | H105310 | 312 | H10545R | 297 | H10578 | 274 |
| H-TASCRN3630 | 770 | H105319 | 304 | H10546L | 297 | H10578X | 274 |
| H-TASCRN3636 | 770 | H105321 | 302 | H10547R | 300 | H10579 | 274 |
| H-TASCRN3648 | 770 | H105321G | 303 | H10548L | 300 | H10579X | 274 |
| H10501 | 289, 340 | H105321K | 302 | H105491 | 300 | H105810 | 310 |
| H105012 | 289 | H105322 | 302 | H105492 | 300 | H105811 | 310 |
| H105014 | 290 | H105322G | 303 | H105493 | 300 | H105815R | 310 |
| H10502 | 289, 340 | H105322K | 302 | H105520 | 316 | H105816L | 310 |
| H10503 | 291, 341 | H105323 | 302 | H105523 | 316 | H105817R | 310 |
| H10504 | 290, 340 | H105323G | 303 | H105524 | 316 | H105818L | 310 |
| H10505 | 291, 341 | H105323K | 302 | H105525R | 316 | H10583R | 296 |
| H105062 | 289 | H105324 | 302 | H105526L | 316 | H10584L | 296 |
| H105064 | 290 | H105324G | 303 | H105527R | 316 | H105851 | 168, 305 |
| H105076 | 291 | H105324K | 302 | H105528L | 316 | H105852 | 168, 305 |
| H105077 | 291 | H105327 | 302 | H105531 | 312 | H105853 | 168, 305 |
| H10508 | 291, 341 | H105327G | 303 | H105532 | 316, 754 | H105854 | 168, 305 |
| H105093 | 289, 340 | H105327K | 302 | H105533 | 316, 754 | H105855 | 168, 305 |
| H105098 | 155, 275, 337 | H10533 | 302 | H105534 | 316, 754 | H105856 | 168, 305 |
| H105099 | 155, 275, 337 | H10533G | 303 | H105535 | 316, 754 | H105857 | 168, 305 |
| H1050CST | 750 | H10533K | 302 | H105581 | 275 | H10585R | 296 |
| H105102 | 311, 350 | H10534 | 302 | H105581X | 275 | H10586L | 296 |
| H105104 | 311, 350 | H105349 | 167, 303 | H105582 | 275 | H10587R | 296 |
| H105106 | 311, 350 | H10534G | 303 | H105582X | 275 | H105885R | 296 |
| H105109 | 311, 350 | H10534K | 302 | H105583 | 275 | H10588L | 296 |
| H10511R | 296 | H10536 | 301 | H105583X | 275 | H105890 | 292 |
| H10512L | 296 | H105360 | 309 | H105598 | 300 | H105891 | 292 |
| H10515R | 296 | H105361 | 309 | H105599 | 300 | H105892 | 292 |
| H10516 | 311 | H105362 | 309 | H10560 | 300 | H105893R | 292 |
| H10516L | 296 | H105363 | 309 | H10561 | 278 | H105894L | 292 |
| H10517 | 311 | H105367 | 301 | H10561X | 278 | H105895R | 292 |
| H105201RE | 298 | H105368 | 301 | H10563 | 311 | H105896L | 292 |
| H105202LE | 298 | H10537 | 301 | H10564 | 275 | H105897R | 292 |
| H105203RE | 298 | H105380 | 306 | H10564X | 275 | H105898L | 292 |
| H105204LE | 298 | H105380G | 309 | H10565 | 297 | H105899 | 292 |
| H105205RE | 299 | H105380K | 306 | H10566 | 297 | H105900 | 293 |
| H105206LE | 299 | H105381 | 306 | H105663 | 277 | H105901 | 293 |
| H105209E | 298 | H105381G | 309 | H105679 | 158, 291, 341 | H105902 | 293 |
| H10521E | 298 | H105381K | 306 | H10568 | 278 | H105903R | 293 |
| H10522E | 298 | H105382 | 306 | H105680 | 278 | H105904L | 293 |
| H10523E | 298 | H105382G | 309 | H105680X | 278 | H105905R | 293 |
| H10524 | 290, 340 | H105382K | 306 | H105681 | 278 | H105906L | 293 |
| H1052441LEP | 280 | H105383 | 306 | H105681X | 278 | H105907R | 293 |
| H10524LEP | 280 | H105383G | 309 | H105684 | 278 | H105908L | 293 |
| H10524TEP | 280 | H105383K | 306 | H105684X | 278 | H105909 | 293 |
| H10524TSUPP | 280 | H105386 | 301 | H105686 | 278 | H10592 | 274 |
| H10525RE | 298 | H105388 | 301 | H10568X | 278 | H10592X | 274 |
| H10526LE | 298 | H105392 | 277 | H105686X | 278 | H10593 | 296 |
| H10528 | 164, 299, 346 | H105393 | 277 | H105690 | 311 | H10594 | 274 |
| H105290 | 312 | H105397 | 277 | H105691 | 275 | H10594X | 274 |
| H105291 | 312 | H10541 | 275 | H105691X | 275 | H10595 | 296 |
| H105292 | 312 | H105410 | 276 | H105692 | 275 | H10596 | 274 |
| H105293 | 315 | H105410X | 276 | H105692X | 275 | H10596X | 274 |
| H105295R | 315 | H105411 | 276 | H105698 | 300 | H105973R | 293 |
| H105296L | 315 | H105411X | 276 | H105699 | 300 | H105974L | 293 |
| H105297R | 315 | H105412 | 276 | H10570 | 300 | H105975R | 293 |
| H105298L | 315 | H105412X | 276 | H10571 | 296 | H105976L | 293 |
| H105299 | 315 | H105413 | 276 | H105720 | 317 | H10598 | 274 |
| H10530 | 315 | H105413X | 276 | H105721 | 173, 317 | H10598X | 274 |
| H105301R | 315 | H10541X | 275 | H105722 | 173, 317 | H105B2460 | 279 |
| H105302L | 315 | H10542 | 275 | H105724 | 317 | H105B3060 | 279 |
| H1053041LEP | 280 | H10542X | 275 | H105726 | 317 | H105B3066 | 279 |

CROSS REFERENCE INDEX

| MODEL | PAGE | MODEL | PAGE | MODEL | PAGE | MODEL | PAGE |
|-------------------|------|------------------|---------------|----------|----------|-----------|------|
| H105B3072 | 279 | H105LT242450CBFL | 313 | H107191R | 343 | H10771 | 344 |
| H105CT3020 | 295 | H105LT242450CBFR | 313 | H107192L | 343 | H107720 | 353 |
| H105CT3024 | 295 | H105LT242450SBFL | 313 | H107193R | 345 | H107721R | 353 |
| H105CT3620 | 295 | H105LT242450SBFR | 313 | H107194L | 345 | H107722L | 353 |
| H105CT3624 | 295 | H105R2430 | 279 | H10721E | 346 | H107725R | 338 |
| H105CTHAT3020 | 295 | H105R2436 | 279 | H10722E | 346 | H107726L | 338 |
| H105CTHAT6020R | 295 | H105R2442 | 279, 285 | H107242 | 353 | H107727R | 338 |
| H105CTHAT3620L | 295 | H105R2448 | 123, 279, 285 | H107270X | 339 | H107727RX | 339 |
| H105CTHAT3620R | 295 | H105R2460 | 123, 279, 285 | H107290 | 350 | H107728L | 338 |
| H105CTHAT3624L | 295 | H105R2466 | 123, 279, 285 | H107291 | 350 | H107728LX | 339 |
| H105CTHAT3624R | 295 | H105R2472 | 123, 279, 285 | H107292 | 350 | H10773 | 342 |
| H105CTHAT6020L | 295 | H105R2478 | 279 | H107293 | 352 | H10774 | 342 |
| H105CTHAT6020R | 295 | H105R2484 | 279 | H107295R | 352 | H10775 | 344 |
| H105CTHAT6024L | 295 | H105R3048 | 123, 279, 285 | H107296L | 352 | H107801R | 338 |
| H105CTHAT6024R | 295 | H105R3060 | 123, 279, 285 | H107299 | 352 | H107801RX | 339 |
| H105CTHAT6620L | 295 | H105R3066 | 123, 279, 285 | H10730 | 352 | H107802L | 338 |
| H105CTHAT6620R | 295 | H105R3072 | 123, 279, 285 | H107301R | 352 | H107802LX | 339 |
| H105CTHAT6624L | 295 | H105R3078 | 279 | H107302L | 352 | H107803R | 338 |
| H105CTHAT6624R | 295 | H105R3084 | 279 | H107313 | 348 | H107803RX | 339 |
| H105CTHAT7220L | 295 | H105ST122450L | 312 | H107313K | 348 | H107804L | 338 |
| H105CTHAT7220R | 295 | H105ST122450R | 312 | H107318 | 348 | H107804LX | 339 |
| H105CTHAT7224L | 295 | H105ST123050L | 312 | H107318K | 348 | H107805R | 338 |
| H105CTHAT7224R | 295 | H105ST123050R | 312 | H10732 | 348 | H107805RX | 339 |
| H105HLEG2428 | 282 | H105WMH30 | 307 | H10732K | 348 | H107806L | 338 |
| H105HLEG2441 | 282 | H105WMH30C | 307 | H10733 | 348 | H107806LX | 339 |
| H105HLEG3028 | 282 | H105WMH36 | 307 | H10733K | 348 | H107807R | 338 |
| H105HLEG3041 | 282 | H105WMH36C | 307 | H10734 | 348 | H107807RX | 339 |
| H105LC3020BF | 294 | H105WMH42 | 307 | H10734G | 348 | H107808L | 338 |
| H105LC3020SF | 294 | H105WMH42C | 307 | H10734K | 348 | H107808LX | 339 |
| H105LC3024BF | 294 | H105WMH48 | 307 | H107353 | 349 | H107811 | 347 |
| H105LC3024SF | 294 | H105WMH48C | 307 | H107358 | 349, 367 | H107815 | 337 |
| H105LC3620BF | 294 | H105WMH48P | 307 | H10736 | 349 | H107815X | 337 |
| H105LC3620SF | 294 | H105WMH48PC | 307 | H10737 | 349 | H107816 | 337 |
| H105LC3624BF | 294 | H105WMH48PCG | 308 | H10738 | 349, 367 | H107816X | 337 |
| H105LC3624SF | 294 | H105WMH48PG | 308 | H107398 | 347 | H107817 | 337 |
| H105LCHAT3020B | 294 | H105WMH60P | 307 | H107399 | 347 | H107817X | 337 |
| H105LCHAT3020S | 294 | H105WMH60PC | 307 | H10741 | 343 | H107824 | 336 |
| H105LCHAT3024S | 294 | H105WMH60PCG | 308 | H10742 | 343 | H107825 | 336 |
| H105LCHAT3620B | 294 | H105WMH60PG | 308 | H10743 | 345 | H107825X | 336 |
| H105LCHAT3620S | 294 | H105WMH66 | 307 | H10744 | 345 | H107826 | 336 |
| H105LCHAT3624S | 294 | H105WMH66C | 307 | H10745R | 345 | H107827 | 336 |
| H105LT182050BFL | 313 | H105WMH66P | 307 | H10746L | 345 | H107829 | 336 |
| H105LT182050BFR | 313 | H105WMH66PC | 307 | H10747R | 347 | H107835 | 337 |
| H105LT182050CBFL | 313 | H105WMH66PCG | 308 | H10748L | 347 | H107836 | 337 |
| H105LT182050CBFR | 313 | H105WMH66PG | 308 | H107492 | 347 | H107837 | 337 |
| H105LT182050SBFL | 313 | H105WMH72P | 307 | H10751 | 347 | H10783R | 344 |
| H105LT182050SBFR | 313 | H105WMH72PC | 307 | H10752 | 351 | H10784L | 344 |
| H105LT182450BFL | 313 | H105WMH72PCG | 308 | H10753 | 351 | H10785R | 344 |
| H105LT182450BFR | 313 | H105WMH72PG | 308 | H10754 | 351 | H10786L | 344 |
| H105LT182450CBFL | 313 | H10701R | 342 | H10755 | 351 | H10787R | 342 |
| H105LT182450CBFR | 313 | H10702L | 342 | H107569 | 351 | H10787RG | 342 |
| H105LT182450SBFL | 313 | H10705R | 343 | H10760 | 347 | H107885R | 344 |
| H105LT182450SBFR | 313 | H10706L | 343 | H10762 | 350 | H10788L | 342 |
| H105LT182450SCBFL | 314 | H10707R | 343 | H10763R | 345 | H10788LG | 342 |
| H105LT182450SCBFR | 314 | H10708L | 343 | H10764L | 345 | H10791 | 344 |
| H105LT242050BFL | 313 | H10709R | 343 | H10765 | 345 | H10799 | 342 |
| H105LT242050BFR | 313 | H10710L | 343 | H10766 | 345 | H10799G | 342 |
| H105LT242050CBFL | 313 | H10711R | 343 | H10767 | 343 | H11501 | 157 |
| H105LT242050CBFR | 313 | H10712L | 343 | H10768 | 343 | H115012 | 157 |
| H105LT242050SBFL | 313 | H10715R | 345 | H107690 | 350 | H115014 | 157 |
| H105LT242050SBFR | 313 | H10716L | 345 | H107698 | 350 | H11502 | 157 |
| H105LT242450BFL | 313 | H10717R | 345 | H107699 | 350 | H11503 | 158 |
| H105LT242450BFR | 313 | H10718L | 345 | H10770 | 347 | H11504 | 157 |

CROSS REFERENCE INDEX

| MODEL | PAGE | MODEL | PAGE | MODEL | PAGE | MODEL | PAGE |
|-----------|------|----------|------|-----------|------------------------------|-----------|----------|
| H11505 | 158 | H11541 | 155 | H11578 | 154 | H212 | 744 |
| H11508 | 158 | H11541X | 155 | H11579 | 154 | H212C | 744 |
| H115093 | 157 | H11542 | 155 | H115811 | 169 | H214 | 744 |
| H115102 | 170 | H11542X | 155 | H115815R | 169 | H214C | 744 |
| H115104 | 170 | H11543 | 162 | H115816L | 169 | H215 | 744 |
| H115106 | 170 | H11544 | 162 | H11583R | 161 | H215C | 744 |
| H115109 | 170 | H11545R | 162 | H11584L | 161 | H312 | 745 |
| H11511R | 161 | H11546L | 162 | H11585R | 161 | H312C | 745 |
| H11512L | 161 | H11547R | 165 | H11586L | 161 | H314 | 745 |
| H11515R | 161 | H11548L | 165 | H11587R | 161 | H314C | 745 |
| H11516 | 170 | H115491 | 165 | H115885R | 161 | H315 | 745 |
| H11516L | 161 | H115492 | 165 | H11588L | 161 | H315C | 745 |
| H11517 | 170 | H115493 | 165 | H115890 | 159 | H32 | 715 |
| H115201RE | 163 | H11552 | 172 | H115891 | 159 | H33720(?) | 656 |
| H115202LE | 163 | H115520 | 172 | H115892 | 159 | H33723(?) | 656 |
| H115203RE | 163 | H115523 | 172 | H115893R | 159 | H33820(?) | 656 |
| H115204LE | 163 | H115524 | 172 | H115894L | 159 | H33823(?) | 656 |
| H11521E | 163 | H115525R | 172 | H115895R | 159 | H34 | 715 |
| H11522E | 163 | H115526L | 172 | H115896L | 159 | H34002R | 389 |
| H11523E | 163 | H115527R | 172 | H115897R | 159 | H34251 | 389 |
| H11525RE | 163 | H115528L | 172 | H115898L | 159 | H34480 | 389 |
| H11526LE | 163 | H11553 | 172 | H115899 | 159 | H34834R | 389 |
| H115290 | 170 | H11554 | 172 | H115900 | 160 | H34835L | 389 |
| H115291 | 170 | H11555 | 172 | H115901 | 160 | H34962 | 389 |
| H115292 | 170 | H115581 | 155 | H115902 | 160 | H34973R | 389 |
| H115293 | 171 | H115581X | 155 | H115903R | 160 | H34974L | 389 |
| H115295R | 171 | H115582 | 155 | H115904L | 160 | H36720(?) | 656 |
| H115296L | 171 | H115582X | 155 | H115905R | 160 | H36723(?) | 656 |
| H115297R | 171 | H115583 | 155 | H115906L | 160 | H36820(?) | 656 |
| H115298L | 171 | H115583X | 155 | H115907R | 160 | H36823(?) | 656 |
| H115299 | 171 | H115598 | 165 | H115908L | 160 | H38155 | 399 |
| H11530 | 171 | H115599 | 165 | H115909 | 160 | H38170 | 399 |
| H115301R | 171 | H11560 | 165 | H11592 | 154 | H38180 | 399 |
| H115302L | 171 | H11561 | 156 | H11593 | 161 | H38210 | 401 |
| H115321 | 166 | H11561X | 156 | H11594 | 154 | H38215R | 399 |
| H115321G | 167 | H11563 | 170 | H11595 | 161 | H38216L | 399 |
| H115321K | 166 | H11564 | 155 | H11596 | 154 | H38217R | 399 |
| H115322 | 166 | H11564X | 155 | H11598 | 154 | H38218L | 399 |
| H115322G | 167 | H11565 | 162 | H14917(?) | 707 | H38220 | 401 |
| H115322K | 166 | H11566 | 162 | H14923(?) | 707 | H38251 | 399 |
| H115323 | 166 | H11568 | 156 | H1522 | 104, 174, 237, 319, 356, 369 | H38252L | 399 |
| H115323G | 167 | H115680 | 156 | H1526 | 104, 174, 237, 319, 356, 369 | H38291R | 399 |
| H115323K | 166 | H115680X | 156 | H15923(?) | 569, 708 | H38292L | 399 |
| H115324 | 166 | H115681 | 156 | H1801 | 755 | H38293R | 399 |
| H115324G | 167 | H115681X | 156 | H1871 | 755 | H38294L | 399 |
| H115324K | 166 | H115684 | 156 | H18717(?) | 707 | H384815 | 405 |
| H115327 | 166 | H115684X | 156 | H1872 | 755 | H386015 | 405 |
| H115327G | 167 | H115686 | 156 | H18723(?) | 707 | H386548N | 383, 405 |
| H115327K | 166 | H115686X | 156 | H18730(?) | 707 | H386560N | 383, 405 |
| H11533 | 166 | H11568X | 156 | H1874 | 755 | H386566N | 383, 405 |
| H11533G | 167 | H115690 | 170 | H1875 | 755 | H386572N | 405 |
| H11533K | 166 | H115691 | 155 | H1876 | 755 | H386615 | 405 |
| H11534 | 166 | H115691X | 155 | H1877 | 755 | H387215 | 405 |
| H11534G | 167 | H115692 | 155 | H18817(?) | 707 | H38851 | 399 |
| H11534K | 166 | H115692X | 155 | H18823(?) | 707 | H38852 | 399 |
| H115380 | 168 | H115698 | 165 | H18830(?) | 707 | H38853 | 399 |
| H115380K | 168 | H115699 | 165 | H19717(?) | 707 | H38854 | 399 |
| H115381 | 168 | H11570 | 165 | H19723(?) | 707 | H38855L | 399 |
| H115381K | 168 | H11571 | 161 | H19730(?) | 707 | H38856R | 399 |
| H115382 | 168 | H115720 | 173 | H19817(?) | 707 | H38857L | 399 |
| H115382K | 168 | H115724 | 173 | H19823(?) | 707 | H38858R | 399 |
| H115383 | 168 | H115726 | 173 | H19830(?) | 707 | H38921 | 400 |
| H115383K | 168 | H11573 | 161 | H20040AG | 750 | H38922 | 400 |

CROSS REFERENCE INDEX

| MODEL | PAGE | MODEL | PAGE | MODEL | PAGE | MODEL | PAGE |
|----------|------------------------------|-------------|------------------|-----------------|------|---------------|---------------|
| H38923 | 400 | H795 | 659 | H919492 | 747 | HAESC19 | 724 |
| H38925 | 400 | H795LS | 660 | H919493 | 747 | HAESS | 726 |
| H38928 | 401 | H80191 | 321 | H9195(?) | 709 | HAEST | 726 |
| H38931 | 400 | H80192 | 321 | H94210 | 368 | HAPGBP196NPT | 722 |
| H38932 | 400 | H80193 | 321 | H94211R | 364 | HAPGBP196NPTE | 723 |
| H38933 | 400 | H872 | 657 | H94212L | 364 | HAPGBP199TFN | 722 |
| H38934 | 400 | H873 | 657 | H94215R | 364 | HAPGBP199TFNE | 723 |
| H38935 | 400 | H874 | 657 | H94216L | 364 | HAPGBP19SNPT | 722 |
| H38941E | 401 | H875 | 657 | H94220 | 368 | HAPGBP19SNPTE | 723 |
| H38942E | 401 | H875LS | 658 | H94221 | 368 | HAPGBP236NPT | 722 |
| H38943R | 400 | H882 | 657 | H94222 | 368 | HAPGBP236NPTE | 723 |
| H38944L | 400 | H88231 | 376 | H94223 | 368 | HAPGBP239TFN | 722 |
| H38945R | 400 | H88235R | 376 | H94224 | 368 | HAPGBP239TFNE | 723 |
| H38946L | 400 | H88236L | 376 | H94225 | 368 | HAPGBS239TFN | 722 |
| H38947R | 400 | H88251R | 375 | H94226 | 368 | HAPGBS239TFNE | 723 |
| H38948L | 400 | H88263R | 375 | H94229 | 368 | HAPGBS23SNPT | 722 |
| H38949R | 400 | H88265R | 375 | H94234 | 366 | HAPGBS23SNPTE | 723 |
| H38950L | 400 | H88266L | 375 | H94234K | 366 | HAPGCP199TPN | 722 |
| H38966E | 401 | H883 | 657 | H94236 | 366 | HAPGCP199TPNE | 723 |
| H38SHFDV | 406, 596 | H884 | 657 | H94237 | 366 | HAPGCP239TPN | 722 |
| H4022 | 112, 174, 325, 357, 370, 401 | H885 | 657 | H94237K | 366 | HAPGCP239TPNE | 723 |
| H4028 | 112, 174, 325, 357, 401 | H885LS | 658 | H94243 | 365 | HAPGCS239TPN | 722 |
| H4029 | 112, 174, 325, 357, 401 | H88962 | 375 | H94244 | 365 | HAPGCS239TPNE | 723 |
| H432 | 741 | H88976 | 375 | H94245R | 365 | HAPMAP196NFN | 720 |
| H434 | 741 | H892 | 657 | H94246L | 365 | HAPMAP196NFNE | 721 |
| H482 | 741 | H893 | 657 | H94247R | 365 | HAPMAP236NFN | 720 |
| H484 | 741 | H894 | 657 | H94248L | 365 | HAPMAP236NFNE | 721 |
| H511596 | 663 | H895 | 657 | H94251 | 364 | HAPMBP196NPT | 720 |
| H512 | 746 | H895LS | 658 | H94260 | 365 | HAPMBP196NPTE | 721 |
| H51206 | 357, 401 | H90031 | 349 | H94270 | 365 | HAPMBP199TFN | 720 |
| H512C | 746 | H90032 | 349 | H94271 | 364 | HAPMBP199TFNE | 721 |
| H514 | 746 | H90033 | 349 | H94276 | 364 | HAPMBP19SNPT | 720 |
| H514C | 746 | H90034 | 349, 367 | H94283R | 364 | HAPMBP19SNPTE | 721 |
| H519495 | 383, 389, 401, 750 | H90035 | 349, 367 | H94284L | 364 | HAPMBP236NPT | 720 |
| H52 | 715 | H90050 | 57, 63, 305 | H94285R | 364 | HAPMBP236NPTE | 721 |
| H52C | 715 | H90051 | 57, 63, 168, 305 | H94286L | 364 | HAPMBP239TFN | 720 |
| H54 | 715 | H90052 | 57, 63, 168, 305 | H94291 | 368 | HAPMBP239TFNE | 721 |
| H54C | 715 | H90053 | 57, 63, 168, 305 | H94430 | 368 | HAPMBS239TFN | 720 |
| H672 | 661 | H90054 | 57, 63, 168, 305 | H94435 | 368 | HAPMBS239TFNE | 721 |
| H673 | 661 | H90055 | 57, 63, 168, 305 | H94720 | 369 | HAPMBS23SNPT | 720 |
| H674 | 661 | H90056 | 57, 63, 168, 305 | H94721R | 369 | HAPMBS23SNPTE | 721 |
| H675 | 661 | H90057 | 57, 63, 168, 305 | H94722L | 369 | HAPMCP199TPN | 720 |
| H682 | 661 | H9170(?) | 709 | HACRYEXSCRN2036 | 769 | HAPMCP199TPNE | 721 |
| H683 | 661 | H9173(?) | 709 | HACRYEXSCRN2042 | 769 | HAPMCP239TPN | 720 |
| H684 | 661 | H9174(?) | 709 | HACRYEXSCRN2536 | 769 | HAPMCP239TPNE | 721 |
| H685 | 661 | H9175(?) | 709 | HACRYEXSCRN2542 | 769 | HAPMCS239TPN | 720 |
| H692 | 661 | H9180(?) | 709 | HACRYSCRN2024 | 769 | HAPMCS239TPNE | 721 |
| H693 | 661 | H9183(?) | 709 | HACRYSCRN2030 | 769 | HARCHA2 | 174, 322, 354 |
| H694 | 661 | H9184(?) | 709 | HACRYSCRN2036 | 769 | HARCHA3 | 174, 322, 354 |
| H695 | 661 | H9185(?) | 709 | HACRYSCRN2048 | 769 | HARCHC2 | 174, 322, 354 |
| H772 | 659 | H9185LS(?) | 710 | HACRYSCRN2054 | 769 | HARCHC3 | 174, 322, 354 |
| H773 | 659 | H9185LSN(?) | 710 | HACRYSCRN2060 | 769 | HAS18 | 664 |
| H774 | 659 | H9190(?) | 709 | HACRYSCRN2066 | 769 | HAS24 | 664 |
| H775 | 659 | H9193(?) | 709 | HACRYSCRN2524 | 769 | HAUFHL15N | 725 |
| H775LS | 660 | H9194(?) | 709 | HACRYSCRN2530 | 769 | HAUFHL15NE | 725 |
| H782 | 659 | H919430 | 674, 675, 747 | HACRYSCRN2536 | 769 | HAUFHR15N | 725 |
| H783 | 659 | H919436 | 674, 675, 747 | HACRYSCRN2548 | 769 | HAUFHR15NE | 725 |
| H784 | 659 | H919442 | 747 | HACRYSCRN2554 | 769 | HAUFO15N | 725 |
| H785 | 659 | H919448 | 674, 675 | HACRYSCRN2560 | 769 | HB9 | 663 |
| H785LS | 660 | H919460 | 674, 675, 747 | HACRYSCRN2566 | 769 | HB96PP | 580 |
| H792 | 659 | H919466 | 747 | HAECBH | 726 | HBCKKIT24 | 628 |
| H793 | 659 | H919472 | 674, 675, 747 | HAEHF | 726 | HBCKKIT24F | 628 |
| H794 | 659 | H919491 | 747 | HAELT | 726 | HBCKKIT30 | 628 |

CROSS REFERENCE INDEX

| MODEL | PAGE | MODEL | PAGE | MODEL | PAGE | MODEL | PAGE |
|--------------|---|--------------|---|--------------|-------------------------|---------------|----------|
| HBCKKIT30F | 628 | HBV-P4260 | 648 | HCTROUGH3610 | 107, 178, 242, | HECC15 | 596 |
| HBCKKIT36 | 628 | HBV-P4272 | 648 | | 595, 613 | HECPPP | 610 |
| HBCKKIT36F | 628 | HBV-P6024 | 648 | HCWD2450P | 626 | HECPP156 | 610 |
| HBCKKIT24 | 628 | HBV-P6030 | 648 | HCWD3062P | 626 | HECSI | 498 |
| HBCKKIT24F | 628 | HBV-P6036 | 648 | HCWQ2424P | 626 | HECSL | 498 |
| HBCKKIT30 | 628 | HBV-P6042 | 648 | HCWQ3030P | 626 | HECSS | 498 |
| HBCKKIT30F | 628 | HBV-P6048 | 648 | HCWQT2424P | 626 | HECST | 498 |
| HBCKKIT36 | 628 | HBV-P6060 | 648 | HCWQT3030P | 626 | HECSV | 498 |
| HBCKKIT36F | 628 | HBV-P6072 | 648 | HD2 | 401 | HECSX | 498 |
| HBCKKIT42 | 628 | HBV-P7224 | 648 | HD8 | 401 | HECSY | 498 |
| HBCKKIT42F | 628 | HBV-P7230 | 648 | HDPS1 | 108, 175, 236, 320, 355 | HECVH07P | 499 |
| HBCKKIT48 | 628 | HBV-P7236 | 648 | HE4022 | 112, 174, 325, 357, 370 | HECVH15P | 499 |
| HBCKKIT48F | 628 | HBV-P7242 | 648 | HEABAC | 500 | HECVH22P | 499 |
| HBCKKIT60 | 628 | HBV-P7248 | 648 | HEBPLATE336 | 493, 607 | HECVH30P | 499 |
| HBCKKIT60F | 628 | HBV-P7260 | 648 | HEBPLATE342 | 493, 607 | HEFEC35P | 499 |
| HBCKKIT66 | 628 | HBV-PBS | 649 | HEBPLATE348 | 493, 607 | HEFEC42P | 499 |
| HBCKKIT66F | 628 | HBV-PWB1 | 649 | HEBPLATE360 | 493, 607 | HEFEC50P | 499 |
| HBCKKIT72 | 628 | HBV-QC180 | 649 | HEBPLATE372 | 493, 607 | HEFEC57P | 499 |
| HBCKKIT72F | 628 | HBV-QC90 | 649 | HEC35P2N | 497 | HEFEC65P | 499 |
| HBCONU | 579 | HBV-TBASE | 649 | HEC35P3N | 497 | HEFEC72P | 499 |
| HBCSRI524P | 627 | HBV-VSH24 | 649 | HEC35PLN | 497 | HEFEC80P | 499 |
| HBCSRI530P | 627 | HBV-VSH30 | 649 | HEC35PSN | 497 | HEFGS0720 | 496 |
| HBCSRI536P | 627 | HBV-VSH36 | 649 | HEC35PTN | 497 | HEFGS0724 | 496 |
| HBCSRI542P | 627 | HBV-VSH42 | 649 | HEC35PXN | 497 | HEFGS0730 | 496 |
| HBCSRI548P | 627 | HBV-VSH48 | 649 | HEC42P2N | 497 | HEFGS0736 | 496 |
| HBCSRI560P | 627 | HBV-VSH60 | 649 | HEC42P3N | 497 | HEFGS0742 | 496 |
| HBCSRI566P | 627 | HBVWM | 580 | HEC42PLN | 497 | HEFGS0748 | 496 |
| HBCSRI572P | 627 | HBWCT3624P | 531, 622 | HEC42PSN | 497 | HEFGS0754 | 496 |
| HBCSR2424P | 627 | HBWCT4224P | 124, 531, 622 | HEC42PTN | 497 | HEFGS0760 | 496 |
| HBCSR3030P | 627 | HBWCT4230P | 124, 531, 622 | HEC42PXN | 497 | HEFGS0766 | 496 |
| HBCSR3636P | 627 | HBWCT4824P | 124, 531, 622 | HEC50P2N | 497 | HEFGS0772 | 496 |
| HBDMAUSB | 113, 126, 180, 235, 326, 359, 371, 378, 385, 391, 403, 643 | HBWCT4830P | 124, 531, 622 | HEC50P3N | 497 | HEFGS1520 | 496 |
| | | HBWD2450P | 626 | HEC50PLN | 497 | HEFGS1524 | 496 |
| HBEAM48 | 578 | HBWD3062P | 626 | HEC50PSN | 497 | HEFGS1530 | 496 |
| HBEAM60 | 578 | HBWQ2424P | 626 | HEC50PTN | 497 | HEFGS1536 | 496 |
| HBEAM72 | 578 | HBWQ3030P | 626 | HEC50PXN | 497 | HEFGS1542 | 496 |
| HBENDCP | 578 | HBWQT2424P | 626 | HEC57P2N | 497 | HEFGS1548 | 496 |
| HBEORH23 | 579 | HBWQT3030P | 626 | HEC57P3N | 497 | HEFGS1554 | 496 |
| HBEORL23 | 579 | HBXRISER | 113, 126, 180, 239, 326, 359, 371, 378, 385, 391, 403, 643 | HEC57PLN | 497 | HEFGS1560 | 496 |
| HBEORT23 | 579 | | | HEC57PSN | 497 | HEFGS1566 | 496 |
| HBFAB | 580 | HC14 | 383, 389 | HEC57PTN | 497 | HEFGS1572 | 496 |
| HBILNH23 | 579 | HCD1 | 174, 237, 325, 356, 370, 401, 642 | HEC57PXN | 497 | HEFTAC | 500 |
| HBILNT23 | 579 | HCLA65 | 105, 176, 236, 325, 356, 639 | HEC65P2N | 497 | HEOHRTA1524FD | 587 |
| HBILNX23 | 579 | HCNLEG29 | 632 | HEC65P3N | 497 | HEOHRTA1530FD | 587 |
| HBLEG23 | 578 | HCOMDOME2 | 107, 122, 179, 243, 377, 384, 390, 402, 546, 612, 641 | HEC65PLN | 497 | HEOHRTA1536FD | 587 |
| HBLPBRIDGE | 143 | | | HEC65PSN | 497 | HEOHRTA1542FD | 587 |
| HBLPCLASSIC | 143 | HCPU1 | 176, 235, 570, 642 | HEC65PTN | 497 | HEOHRTA1548FD | 587 |
| HBLPCONTEMP | 143 | HCRESCENTA2 | 322, 354 | HEC65PXN | 497 | HEOHRTA1560FD | 587 |
| HBMP2B | 749 | HCRESCENTA3 | 322, 354 | HEC72P2N | 497 | HEOHRTA1572FD | 587 |
| HBMP2F | 749 | HCRESCENTC2 | 322, 354 | HEC72P3N | 497 | HEP35 | 610 |
| HBPPCK | 580 | HCRESCENTC3 | 322, 354 | HEC72PLN | 497 | HEP65 | 610 |
| HBPPEK | 580 | HCS3636P | 629 | HEC72PSN | 497 | HEPDMK42P | 492 |
| HBPPMK | 580 | HCS4242P | 629 | HEC72PTN | 497 | HERECPCVR | 545, 610 |
| HBPPSK | 580 | HCTL181L | 632 | HEC72PXN | 497 | HES1520F | 494 |
| HBPRTCV | 579 | HCTL181R | 632 | HEC80P2N | 497 | HES1520G | 495 |
| HBSCRAOMTL48 | 582 | HCTL182 | 632 | HEC80P3N | 497 | HES1524F | 494 |
| HBSCRAOMTL60 | 582 | HCTL241L | 632 | HEC80PLN | 497 | HES1524G | 495 |
| HBSCRAOMTL72 | 582 | HCTL241R | 632 | HEC80PSN | 497 | HES1530F | 494 |
| HBV-P4224 | 648 | HCTL242 | 632 | HEC80PTN | 497 | HES1530G | 495 |
| HBV-P4230 | 648 | HCTROUGH17 | 107, 178, 242, 595, 613 | HEC80PXN | 497 | HES1536F | 494 |
| HBV-P4236 | 648 | HCTROUGH1710 | 107, 178, 242, 595, 613 | HECB01 | 628 | HES1536G | 495 |
| HBV-P4242 | 648 | HCTROUGH36 | 107, 178, 242, 595, 613 | HECB42 | 628 | HES1542F | 494 |
| HBV-P4248 | 648 | | | HECC10 | 596 | HES1542G | 495 |

CROSS REFERENCE INDEX

| MODEL | PAGE | MODEL | PAGE | MODEL | PAGE | MODEL | PAGE |
|------------|------|-----------------|------------------------------|----------------|-----------------------------------|---------------|-------------------|
| HES1548F | 494 | HETP5024DP | 491 | HFMBIN12 | 711 | HH871230A | 608 |
| HES1548G | 495 | HETP5024FP | 490 | HFMBIN3 | 711 | HH871236 | 608 |
| HES1560F | 494 | HETP5030DP | 491 | HFMBIN6 | 711 | HH871236A | 608 |
| HES1560G | 495 | HETP5030FP | 490 | HFMSC182830RWB | 711 | HH871242 | 608 |
| HES1572F | 494 | HETP5036DP | 491 | HFMSC183930RWB | 711 | HH871242A | 608 |
| HES1572G | 495 | HETP5036FP | 490 | HFMSC185230RWB | 711 | HH871248 | 544, 581, 608 |
| HES3020G | 495 | HETP5042DP | 491 | HFMSC186430RWB | 711 | HH871248A | 544, 581, 608 |
| HES3024G | 495 | HETP5042FP | 490 | HFSC183640(?) | 713 | HH871260 | 544, 581, 608 |
| HES3030G | 495 | HETP5048DP | 491 | HFSC183640W | 712 | HH871260A | 544, 581, 608 |
| HES3036G | 495 | HETP5048FP | 490 | HFSC183664(?) | 713 | HH871272 | 544, 581, 608 |
| HES3042G | 495 | HETP5060DP | 491 | HFSC183664W | 712 | HH871272A | 544, 581, 608 |
| HES3048G | 495 | HETP5060FP | 490 | HFTPD | 121 | HH871366 | 609 |
| HES3060G | 495 | HETP5072DP | 491 | HGRMTAC | 106, 178, 241, 324, 358, 613, 629 | HH871366A | 609 |
| HESDMK30 | 492 | HETP5072FP | 490 | HGRMTAC2 | 106, 122, 178, 241, 324, 358 | HH871400 | 545, 609 |
| HESDMK36 | 492 | HETP6520DP | 491 | HGRMTAC2 | 106, 122, 178, 241, 324, 358 | HH871400A | 545, 609 |
| HESDMK42 | 492 | HETP6520FP | 490 | HGRMTDATA | 241 | HH871500 | 545, 609 |
| HESDMK48 | 492 | HETP6524DP | 491 | HGRMTUSB2 | 106, 122, 178, 241, 324, 358, 613 | HH871501 | 545, 611 |
| HESHRTA24 | 587 | HETP6524FP | 490 | HH15042SD | 451, 492 | HH871501A | 545, 611 |
| HESHRTA30 | 587 | HETP6530DP | 491 | HH16542SD | 451, 492 | HH871502 | 545, 611 |
| HESHRTA36 | 587 | HETP6530FP | 490 | HH18042SD | 451, 492 | HH871502A | 545, 611 |
| HESHRTA42 | 587 | HETP6536DP | 491 | HH870070 | 242, 580, 610 | HH871503 | 545, 611 |
| HESHRTA48 | 587 | HETP6536FP | 490 | HH870924(?) | 595 | HH871503A | 545, 611 |
| HESHRTA60 | 587 | HETP6542DP | 491 | HH870930(?) | 111, 177, 309 | HH871504 | 545, 611 |
| HESHRTA72 | 587 | HETP6542FP | 490 | HH870930CH | 111 | HH871506 | 545, 611 |
| HETB2018 | 594 | HETP6548DP | 491 | HH870942 | 111, 177, 309, 357, 407 | HH871601 | 545, 581, 611 |
| HETB2418 | 594 | HETP6548FP | 490 | HH870942(?) | 595 | HH871601A | 581, 611 |
| HETB3018 | 594 | HETP6560DP | 491 | HH870942CH | 111 | HH871912 | 544, 581, 609 |
| HETB3618 | 594 | HETP6560FP | 490 | HH870960 | 111, 177, 309, 357, 367, 407 | HH871912A | 581, 609 |
| HETB4218 | 594 | HETP6572DP | 491 | HH870960(?) | 595 | HH871918 | 581, 609 |
| HETB4818 | 594 | HETP6572FP | 490 | HH870960CH | 111, 367 | HH871918A | 581, 609 |
| HETB6018 | 594 | HEVHF07P | 499 | HH871024 | 544, 608 | HH873500 | 609 |
| HETB7218 | 594 | HEVHF15P | 499 | HH871024A | 544, 608 | HH873501 | 581, 611 |
| HETC20 | 493 | HEVHF22P | 499 | HH871030 | 608 | HH873501A | 581, 611 |
| HETC24 | 493 | HEVHF30P | 499 | HH871030A | 608 | HH873502 | 581, 611 |
| HETC30 | 493 | HEVHG07P | 496 | HH871036A | 608 | HH873502A | 581, 611 |
| HETC36 | 493 | HEVHG15P | 496 | HH871042 | 608 | HH873503 | 581, 611 |
| HETC42 | 493 | HEWS35P | 499 | HH871042A | 608 | HH873503A | 581, 611 |
| HETC48 | 493 | HEWS42P | 499 | HH871048 | 544, 608 | HH873504 | 581, 611 |
| HETC60 | 493 | HEWS50P | 499 | HH871048A | 544, 608 | HH873506 | 581, 611 |
| HETC66 | 493 | HEWS57P | 499 | HH871060 | 544, 608 | HH879072 | 609 |
| HETC72 | 493 | HEWS65P | 499 | HH871060A | 544, 608 | HH879072A | 609 |
| HETC78 | 493 | HEWS72P | 499 | HH871072 | 544, 608 | HH879168 | 609 |
| HETC84 | 493 | HEWS80P | 499 | HH871124 | 608 | HH879168A | 609 |
| HETC90 | 493 | HF22 | 750, 773 | HH871124A | 608 | HH8988EBN | 613 |
| HETC96 | 493 | HF23B | 110, 174, 323, 356, 370, 773 | HH871130 | 608 | HHABBT | 121 |
| HETP3520FP | 490 | HF23C | 750, 773 | HH871130A | 608 | HHABCTRPK | 121 |
| HETP3524FP | 490 | HF23S | 110, 323, 675, 773 | HH871136 | 608 | HHABETA2S2L | 120 |
| HETP3530FP | 490 | HF24 | 748, 773 | HH871136A | 608 | HHABGLIDE | 121 |
| HETP3536FP | 490 | HF246 | 748, 773 | HH871142 | 608 | HHALGPT | 479 |
| HETP3542FP | 490 | HF27B | 110, 323, 356, 773 | HH871142A | 608 | HHALREC | 479 |
| HETP3548FP | 490 | HF27S | 110, 323, 773 | HH871148 | 544, 608 | HHALRECL | 479 |
| HETP3560FP | 490 | HF50 | 748 | HH871148A | 544, 608 | HHALRECR | 479 |
| HETP3572FP | 490 | HF60 | 748 | HH871160 | 544, 608 | HHALRETG | 479 |
| HETP4220FP | 490 | HF80 | 750 | HH871160A | 544, 608 | HHALRETL | 479 |
| HETP4224FP | 490 | HFHACRYSCRN6036 | 771 | HH871172 | 544, 608 | HHALRETR | 479 |
| HETP4230FP | 490 | HFHACRYSCRN6048 | 771 | HH871172A | 544, 608 | HHATB2S2LC | 117, 207 |
| HETP4236FP | 490 | HFHACRYSCRN7236 | 771 | HH871224 | 608 | HHATB2S2LT | 95, 117, 207, 286 |
| HETP4242FP | 490 | HFHACRYSCRN7248 | 771 | HH871224A | 608 | HHATB3S2LC | 117, 207 |
| HETP4248FP | 490 | HFHPCSCRN6048 | 771 | HH871224 | 608 | HHATB3S2LT | 117, 207 |
| HETP4260FP | 490 | HFHPCSCRN7248 | 771 | HH871224A | 608 | HHATB3S3LC | 117, 207 |
| HETP4272FP | 490 | HFLDGRMT | 106, 177, 324, 358 | HH871230 | 608 | HHATB3S3LT | 117, 207 |
| HETP5020DP | 491 | HFLDGRMT3 | 106, 177, 242, 324, 358 | HH871230A | 608 | HHATCC583422L | 119 |
| HETP5020FP | 490 | HFLDGRMT4 | 106 | HH871230 | 608 | HHATCC583422R | 119 |

CROSS REFERENCE INDEX

| MODEL | PAGE | MODEL | PAGE | MODEL | PAGE | MODEL | PAGE |
|---------------|----------|------------------|-------------------------|------------------|--|-----------------|------|
| HHATCC584622L | 119 | HHATW2888CT | 118 | HLCRPL4824WFH-US | 129 | HLPLDR48GS | 142 |
| HHATCC584622R | 119 | HHATW2894CT | 118 | HLCRPL4824WFH | 129 | HLPLDR48LM | 142 |
| HHATCC584628L | 119 | HHATW2946EM | 533 | HLCRPL4830WFH-PS | 129 | HLPLDR60GS | 142 |
| HHATCC584628R | 119 | HHATW2958EM | 533 | HLCRPL4830WFH-US | 129 | HLPLDR60LM | 142 |
| HHATCC603624L | 119 | HHATW2970EM | 533 | HLCRPL4830WFH | 129 | HLPLDR66GS | 142 |
| HHATCC603624R | 119 | HHATW3042CT | 118 | HLCRPL5424WFH-PS | 129 | HLPLDR66LM | 142 |
| HHATCC604824L | 119 | HHATW3048CT | 118 | HLCRPL5424WFH-US | 129 | HLPLDR72GS | 142 |
| HHATCC604824R | 119 | HHATW3048EA | 120 | HLCRPL5424WFH | 129 | HLPLDR72LM | 142 |
| HHATCC604830L | 119 | HHATW3054CT | 118 | HLCRPL5430WFH-PS | 129 | HLPLDS4830 | 140 |
| HHATCC604830R | 119 | HHATW3054EA | 120 | HLCRPL5430WFH-US | 129 | HLPLDS6030 | 140 |
| HHATCC703422L | 119 | HHATW3060CT | 118 | HLCRPL5430WFH | 129 | HLPLDS6630 | 140 |
| HHATCC703422R | 119 | HHATW3060EA | 120 | HLCWFH-PS | 130 | HLPLDS7230 | 140 |
| HHATCC704622L | 119 | HHATW3066CT | 118 | HLCWFH-US | 130 | HLPLDS7236 | 140 |
| HHATCC704622R | 119 | HHATW3072CT | 118 | HLDST1 | 108, 175, 236, 319, 355 | HLPLDS7236B | 140 |
| HHATCC704628L | 119 | HHATW3078CT | 118 | HLED1 | 111, 177, 238, 325, 357, 407, 640 | HLPLFB24 | 145 |
| HHATCC704628R | 119 | HHATW3084CT | 118 | HLED17A | 111, 177, 234, 309, 357, 407, 595 | HLPLLEG24A | 145 |
| HHATCC723624L | 119 | HHATW3090CT | 118 | HLED17AS | 111, 177, 234, 309, 357, 367, 407, 595 | HLPLLEG24U | 145 |
| HHATCC723624R | 119 | HHATW3096CT | 118 | HLED17AUO | 111, 177, 234, 309, 357, 407, 595 | HLPLLEG30A | 145 |
| HHATCC724824L | 119 | HHC-TASCRN3630 | 770 | HLED17AUC | 111, 177, 234, 309, 357, 407, 595 | HLPLLEG30U | 145 |
| HHATCC724824R | 119 | HHC-TASCRN3636 | 770 | HLED17AUC | 111, 177, 234, 309, 357, 407, 595 | HLPLLF3620L2 | 144 |
| HHATCC724830L | 119 | HHC-TASCRN3648 | 770 | HLED17AUC | 111, 177, 234, 309, 357, 407, 595 | HLPLLF3620L3 | 144 |
| HHATCC724830R | 119 | HHCMT24 | 613 | HLED17AUC | 111, 177, 234, 309, 357, 407, 595 | HLPLLF3620L4 | 144 |
| HHATM3S2LT | 117, 207 | HHCMT36 | 613 | HLED2 | 111, 177, 238, 325, 357, 407, 640 | HLPLLOS10 | 145 |
| HHATW2240CT | 118 | HHEM620 | 613 | HLED31A | 111, 177, 234, 309, 357, 407, 595 | HLPLPLOS23 | 145 |
| HHATW2246CT | 118 | HHKDMK30 | 451 | HLED31AS | 111, 177, 234, 309, 357, 367, 407, 595 | HLPLPEN6630E | 141 |
| HHATW2246EA | 120 | HHKDMK36 | 451 | HLED31AUC | 111, 177, 234, 309, 357, 407, 595 | HLPLPEN7236E | 141 |
| HHATW2252CT | 118 | HHKDMK42 | 451 | HLED31AS | 111, 177, 234, 309, 357, 367, 407, 595 | HLPLPHBF | 143 |
| HHATW2252EA | 120 | HHKDMK48 | 451 | HLED31AUC | 111, 177, 234, 309, 357, 407, 595 | HLPLPMBBF | 143 |
| HHATW2258CT | 118 | HHRMK36 | 594, 639 | HLED31AUC | 111, 177, 234, 309, 357, 407, 595 | HLPLPMBF | 143 |
| HHATW2258EA | 120 | HHRMK42 | 594, 639 | HLEDOSA | 111, 177, 234, 309, 357, 407, 595 | HLPLPMFF | 143 |
| HHATW2264CT | 118 | HHRMK48 | 594, 639 | HLINEARA2 | 174, 322, 354 | HLPLPMBBF | 143 |
| HHATW2270CT | 118 | HHN831118 | 632, 737 | HLINEARA3 | 174, 322, 354 | HLPLPSEAT1520 | 143 |
| HHATW2276CT | 118 | HHN831124 | 419, 632 | HLINEARC2 | 174, 322, 354 | HLPLPSFF | 143 |
| HHATW2282CT | 118 | HHN831130 | 419, 632 | HLINEARC3 | 174, 322, 354 | HLPLRCPNDS7230 | 148 |
| HHATW2288CT | 118 | HHPMC6 | 469, 492 | HPLB3624 | 140 | HLPLRCPNRS4225 | 148 |
| HHATW2294CT | 118 | HHPS1 | 108, 175, 236, 320, 355 | HPLB4224 | 140 | HLPLRCPNTPGS | 148 |
| HHATW2346EM | 533 | HHT2DP | 611 | HPLB4824 | 140 | HLPLRCPNTPLM | 148 |
| HHATW2358EM | 533 | HHTADF3 | 581, 613 | HPLBC3013B2 | 144 | HLPLRS3624 | 140 |
| HHATW2370EM | 533 | HHTADF4 | 581, 613 | HPLBC3013B4 | 144 | HLPLRS4224 | 140 |
| HHATW2442CT | 118 | HHTADJ5 | 581, 613 | HPLBC3013B5 | 144 | HLPLRS4824 | 140 |
| HHATW2448CT | 118 | HHTADJ6 | 581, 613 | HLPLCL3020BF | 146 | HLPLRW4824 | 145 |
| HHATW2448EA | 120 | HICG12 | 450, 492 | HLPLCL3020S | 146 | HLPLRW4830 | 145 |
| HHATW2454CT | 118 | HKBS | 237, 642 | HLPLCL3020TOP | 146 | HLPLRW6024 | 145 |
| HHATW2454EA | 120 | HKP2800 | 751 | HLPLCL3620BF | 146 | HLPLRW6030 | 145 |
| HHATW2460CT | 118 | HLAM3348RR | 66, 318 | HLPLCL3620S | 146 | HLPLRW6624 | 145 |
| HHATW2460EA | 120 | HLAM3772RD | 66, 318 | HLPLCL3620TOP | 146 | HLPLRW6630 | 145 |
| HHATW2466CT | 118 | HLAMMP6030 | 85, 288 | HLPLCL6020TOP | 146 | HLPLRW7224 | 145 |
| HHATW2472CT | 118 | HLAMMP7230 | 85, 288 | HLPLCL6620TOP | 146 | HLPLRW7230 | 145 |
| HHATW2478CT | 118 | HLAMSEAT3024 | 295 | HLPLCL7220TOP | 146 | HLPLSC3620 | 144 |
| HHATW2484CT | 118 | HLAMSEAT3624 | 295 | HLPLCS30 | 141 | HLPLSL24 | 145 |
| HHATW2490CT | 118 | HLAMSHB30 | 95, 286 | HLPLCS36 | 141 | HLPLSL30 | 145 |
| HHATW2496CT | 118 | HLCPL29WFH-PS | 130 | HLPLCS4824 | 140 | HLPLTACK48 | 142 |
| HHATW2840CT | 118 | HLCPL29WFH-US | 130 | HLPLCS6024 | 140 | HLPLTACK60 | 142 |
| HHATW2846CT | 118 | HLCPL29WFH | 130 | HLPLCS6624 | 140 | HLPLTACK66 | 142 |
| HHATW2846EA | 120 | HLCR2442WFH | 130 | HLPLCS7224 | 140 | HLPLTACK72 | 142 |
| HHATW2852CT | 118 | HLCR2448WFH | 130 | HLPLCSEAT3020 | 146 | HLPLTBL120BASE | 147 |
| HHATW2852EA | 120 | HLCR2454WFH | 130 | HLPLCSEAT3620 | 146 | HLPLTBL3672RCT | 147 |
| HHATW2858CT | 118 | HLCR3048WFH | 130 | HLPLDH60 | 142 | HLPLTBL36BASE | 147 |
| HHATW2858EA | 120 | HLCR3054WFH | 130 | HLPLDH66 | 142 | HLPLTBL36RND | 147 |
| HHATW2864CT | 118 | HLCRPL4224WFH-PS | 129 | HLPLDH72 | 142 | HLPLTBL4296RCT | 147 |
| HHATW2870CT | 118 | HLCRPL4224WFH-US | 129 | HLPLDR12MB | 142 | HLPLTBL42BASE | 147 |
| HHATW2876CT | 118 | HLCRPL4824WFH | 129 | | | HLPLTBL42RND | 147 |
| HHATW2882CT | 118 | HLCRPL4824WFH-PS | 129 | | | HLPLTBL4812ORCT | 147 |

CROSS REFERENCE INDEX

| MODEL | PAGE | MODEL | PAGE | MODEL | PAGE | MODEL | PAGE |
|---------------|---|--------------|--------------------------------------|-------------|-----------------------|------------|-------------------|
| HLPLTBL48BASE | 147 | HLSL154LSD | 227 | HLSL22OSPL | 217, 593 | HLSL4831MB | 234 |
| HLPLTBL48RND | 147 | HLSL154LSO | 227 | HLSL2428B | 208, 637 | HLSL4835TS | 213 |
| HLPLTBL72BASE | 147 | HLSL1760SOL | 217, 593 | HLSL2428E | 203 | HLSL48TW | 216, 218 |
| HLPLTBL96BASE | 147 | HLSL1760SOR | 217, 593 | HLSL2428EBL | 631 | HLSL4AM2 | 203 |
| HLPLW1824 | 144 | HLSL1772SOL | 217, 593 | HLSL2428EBR | 631 | HLSL500S | 218, 592 |
| HLPLW2424 | 144 | HLSL1772SOR | 217, 593 | HLSL2428F | 208, 637 | HLSL5414L | 85, 125, 210, 287 |
| HLPLWMH48 | 142 | HLSL2016FP2 | 232 | HLSL2428O | 92, 202, 283, 630 | HLSL5414MM | 85, 125, 211, 288 |
| HLPLWMH60 | 142 | HLSL2016MP2 | 225, 549 | HLSL2428S | 208, 637 | HLSL5435TS | 213 |
| HLPLWMH66 | 142 | HLSL2016PH2 | 69, 225, 549 | HLSL2428SL | 92, 202, 284 | HLSL6014L | 85, 125, 210, 287 |
| HLPLWMH72 | 142 | HLSL2020TS | 213 | HLSL2430L | 209, 638 | HLSL6014MM | 85, 125, 211, 288 |
| HLPLXS60 | 145 | HLSL2024TS | 213 | HLSL2430MF | 209, 638 | HLSL6028O | 92, 202, 283 |
| HLPLXS66 | 145 | HLSL2028B | 208, 637 | HLSL2436L2 | 226 | HLSL6035TS | 213 |
| HLPLXS72 | 145 | HLSL2028E | 203 | HLSL2436L4 | 226 | HLSL60TW | 216, 218 |
| HLSL1212 | 108, 175, 218, 234, 320, 355, 377, 384, 390, 402, 592 | HLSL2028F | 208, 637 | HLSL2436SC | 226 | HLSL650S | 218, 592 |
| | | HLSL2028O | 202, 630 | HLSL2441O | 92, 204, 283, 635 | HLSL6635TS | 213 |
| HLSL1220FS | 214 | HLSL2028SL | 202 | HLSL2441S | 205 | HLSL66TW | 216, 218 |
| HLSL1220GS | 214 | HLSL2030CH2 | 48, 69, 221, 225, 295, 547, 548, 549 | HLSL2441SL | 92, 204, 283, 635 | HLSL7235TS | 213 |
| | | | | HLSL2472LC | 226 | HLSL7265TE | 219 |
| HLSL1224FS | 96, 214 | HLSL2030LDO | 224, 548 | HLSL247O | 92, 202, 221, 284 | HLSL72TW | 216, 218 |
| HLSL1224GS | 96, 214 | HLSL2030LDOF | 222 | HLSL247SL | 202 | HLSL78TW | 216, 218 |
| HLSL1224TS | 213 | HLSL2030LD1 | 224, 548 | HLSL24OBC | 209, 638 | HSLDRWORG | 234 |
| HLSL1230 | 96, 212, 288, 344 | HLSL2030LD1F | 222 | HLSL2814LM | 86, 210 | HSLPBL | 203, 630 |
| HLSL1230FS | 96, 214 | HLSL2030LD2 | 224, 548 | HLSL2828LM | 86, 210 | HSLPBR | 203, 630 |
| HLSL1230GS | 96, 214 | HLSL2030LD2F | 222 | HLSL2830 | 96, 212 | HSLPMB | 592 |
| HLSL1230TS | 213 | HLSL2030MCO | 225, 549 | HLSL2836 | 96, 212 | HSLPMBSO42 | 217, 593 |
| HLSL1236 | 96, 212, 288, 344 | HLSL2030TS | 213 | HLSL2842 | 96, 212 | HSLPMBSOA | 217, 593 |
| | | | | HLSL2848 | 96, 212 | HSLPMBSOB | 217, 593 |
| HLSL1236FS | 96, 214 | HLSL2036CH2 | 48, 221, 295, 547, 548 | HLSL2854 | 96, 212 | HSLR1330 | 218, 227 |
| HLSL1236GS | 96, 214 | HLSL2036L2 | 226 | HLSL2860 | 96, 212 | HSLR1336 | 218, 227 |
| HLSL1236TS | 213 | HLSL2036L4 | 226 | HLSL28AM2 | 203 | HSLR1345 | 218, 227 |
| HLSL1242 | 96, 212, 288, 344 | HLSL2036LDO | 224, 548 | HLSL28AW2 | 203 | HSLR2036 | 198 |
| HLSL1248 | 96, 212, 288, 344 | HLSL2036LDOF | 222 | HLSL28P | 45, 93, 203, 281, 632 | HSLR2042 | 198 |
| HLSL1254 | 96, 212, 288, 344 | HLSL2036LD1 | 224, 548 | HLSL3014L | 85, 125, 210, 287 | HSLR2048 | 198 |
| HLSL1260 | 96, 212, 288, 344 | HLSL2036LD1F | 222 | HLSL3014MM | 85, 125, 211, 288 | HSLR2054 | 198 |
| HLSL1336B2 | 233 | HLSL2036LD2 | 224, 548 | HLSL3028B | 208, 637 | HSLR2060 | 198 |
| HLSL1336B3 | 233 | HLSL2036LD2F | 222 | HLSL3028E | 203 | HSLR2066 | 198 |
| HLSL1336B4 | 233 | HLSL2036SC | 226 | HLSL3028EBL | 631 | HSLR2072 | 198 |
| HLSL1436BH | 226 | HLSL2036TS | 213 | HLSL3028EBR | 631 | HSLR2436 | 198 |
| HLSL1436D | 215, 591 | HLSL2060LDO | 220, 547 | HLSL3028F | 208, 637 | HSLR2442 | 198 |
| HLSL1436S | 215, 590 | HLSL2060LDOF | 222 | HLSL3028O | 92, 202, 283, 630 | HSLR2448 | 198, 206 |
| HLSL1442D | 215, 591 | HLSL2060LD2 | 220, 547 | HLSL3028S | 208, 637 | HSLR2448J | 200 |
| HLSL1442S | 215, 590 | HLSL2060LD2F | 222 | HLSL3028SL | 92, 202, 284 | HSLR2454 | 198, 206 |
| HLSL1448D | 215, 591 | HLSL2060LD4 | 220, 547 | HLSL3041O | 92, 204, 283, 635 | HSLR2460 | 198, 206 |
| HLSL1448S | 215, 590 | HLSL2060LD4F | 222 | HLSL3041S | 205 | HSLR2460J | 200 |
| HLSL1460D | 215, 591 | HLSL2060LL2 | 220, 547 | HLSL3041SL | 92, 204, 283, 635 | HSLR2466 | 198, 206 |
| HLSL1460LS | 234 | HLSL2060LL2F | 223 | HLSL307O | 92, 202, 221, 284 | HSLR2472 | 198, 206 |
| HLSL1460M | 216, 592 | HLSL2060LR2 | 220, 547 | HLSL307SL | 202 | HSLR2472J | 200 |
| HLSL1460S | 215, 590 | HLSL2060LR2F | 223 | HLSL30OBC | 209, 638 | HSLR2484 | 198 |
| HLSL1466D | 215, 591 | HLSL2060S4 | 220, 547 | HLSL3414LM | 86, 210 | HSLR3036 | 199 |
| HLSL1466M | 216, 592 | HLSL2060S4F | 223 | HLSL3428LM | 86, 210 | HSLR3042 | 199 |
| HLSL1466S | 215, 590 | HLSL2072LDO | 220, 547 | HLSL3614L | 85, 125, 210, 287 | HSLR3048 | 199, 206 |
| HLSL1472D | 215, 591 | HLSL2072LDOF | 222 | HLSL3614MM | 85, 125, 211, 288 | HSLR3048J | 200 |
| HLSL1472DB | 219 | HLSL2072LD2 | 220, 547 | HLSL3635TS | 213 | HSLR3054 | 199, 206 |
| HLSL1472LS | 234 | HLSL2072LD2F | 222 | HLSL36TW | 216, 218 | HSLR3060 | 199, 206 |
| HLSL1472M | 216, 592 | HLSL2072LD4 | 220, 547 | HLSL4014LM | 86, 210 | HSLR3060J | 200 |
| HLSL1472MB | 216 | HLSL2072LD4F | 222 | HLSL4028LM | 86, 210 | HSLR3066 | 199, 206 |
| HLSL1472S | 215, 590 | HLSL2072LL2 | 220, 547 | HLSL4214L | 85, 125, 210, 287 | HSLR3072 | 199, 206 |
| HLSL1472SB | 219 | HLSL2072LL2F | 223 | HLSL4214MM | 85, 125, 211, 288 | HSLR3072J | 200 |
| HLSL14OSPL | 217, 593 | HLSL2072LR2 | 220, 547 | HLSL4235TS | 213 | HSLR3084 | 199 |
| HLSL1512LSCL | 227 | HLSL2072LR2F | 223 | HLSL42TW | 216, 218 | HSLR3660 | 199 |
| HLSL1512LSCR | 227 | HLSL2072S4 | 220, 547 | HLSL4814L | 85, 125, 210, 287 | HSLR3666 | 199 |
| HLSL1512LSO | 227 | HLSL2072S4F | 223 | HLSL4814MM | 85, 125, 211, 288 | HSLR3672 | 199 |
| HLSL1530SOMB | 104, 217, 593 | HLSL207O | 202, 221 | HLSL4828O | 92, 202, 283 | HLSLSB | 218 |
| HLSL1536SOMB | 104, 217, 593 | HLSL207SL | 202 | | | | |

CROSS REFERENCE INDEX

| MODEL | PAGE | MODEL | PAGE | MODEL | PAGE | MODEL | PAGE |
|----------------|------------------------------|------------|------|---------------|---------------|----------------|--|
| HLSLSPBL | 204 | HMP2472PK2 | 538 | HMPFSS3613 | 535 | HMPTROUGH60 | 528 |
| HLSLSPBR | 204 | HMP2472PK4 | 538 | HMPFSS3620 | 535 | HMPTROUGH72 | 528 |
| HLSLW045L | 229, 550 | HMP2472PK6 | 538 | HMPFSS4213 | 535 | HMPUB148 | 527, 529 |
| HLSLW045LF | 231 | HMP2472PK8 | 538 | HMPFSS4220 | 535 | HMPUB160 | 527, 529 |
| HLSLW045R | 229, 550 | HMP3060PK2 | 538 | HMPFSS4813 | 535 | HMPUB172 | 527 |
| HLSLW045RF | 231 | HMP3060PK4 | 538 | HMPFSS4820 | 535 | HMPUB248 | 527 |
| HLSLW046L | 229, 550 | HMP3060PK6 | 538 | HMPFSS5413 | 535 | HMPUB260 | 527 |
| HLSLW046R | 229, 550 | HMP3060PK8 | 538 | HMPFSS5420 | 535 | HMPUB272 | 527 |
| HLSLW084L | 231 | HMP3072PK2 | 538 | HMPFSS6013 | 535 | HMPVWM28 | 107, 179, 243, 377, 384, 390, 402, 546, 612, 641 |
| HLSLW084LF | 231 | HMP3072PK4 | 538 | HMPFSS6020 | 535 | HMTLEXSCRN2036 | 768 |
| HLSLW084R | 231 | HMP3072PK6 | 538 | HMPHA2460PK2 | 539 | HMTLEXSCRN2042 | 768 |
| HLSLW084RF | 231 | HMP3072PK8 | 538 | HMPHA2460PK4 | 539 | HMTLEXSCRN2536 | 768 |
| HLSLW085L | 230, 551 | HMP3072PK2 | 538 | HMPHA2460PK6 | 539 | HMTLEXSCRN2542 | 768 |
| HLSLW085LF | 231 | HMP3072PK4 | 538 | HMPHA2460PK8 | 539 | HMTLSCRN2024 | 768 |
| HLSLW085R | 230, 551 | HMP3072PK6 | 538 | HMPHA2472PK2 | 539 | HMTLSCRN2030 | 768 |
| HLSLW085RF | 231 | HMP3072PK8 | 538 | HMPHA2472PK4 | 539 | HMTLSCRN2036 | 768 |
| HLSLW086L | 230, 551 | HMP3072PK2 | 538 | HMPHA2472PK6 | 539 | HMTLSCRN2048 | 121, 768 |
| HLSLW086R | 230, 551 | HMP3072PK4 | 538 | HMPHA2472PK8 | 539 | HMTLSCRN2054 | 121, 768 |
| HLSLW1224L | 205 | HMP3072PK6 | 538 | HMPHA2S4C | 532 | HMTLSCRN2060 | 121, 768 |
| HLSLW1224R | 205 | HMP3072PK8 | 538 | HMPHA3060PK2 | 539 | HMTLSCRN2066 | 121, 768 |
| HLSLW1230L | 205 | HMP3072PK2 | 538 | HMPHA3060PK4 | 539 | HMTLSCRN2524 | 768 |
| HLSLW1230R | 205 | HMP3072PK4 | 538 | HMPHA3060PK6 | 539 | HMTLSCRN2530 | 768 |
| HLSLW445L | 229, 550 | HMP3072PK6 | 538 | HMPHA3060PK8 | 539 | HMTLSCRN2536 | 768 |
| HLSLW445LF | 231 | HMP3072PK8 | 538 | HMPHA3072PK2 | 539 | HMTLSCRN2548 | 121, 768 |
| HLSLW445R | 229, 550 | HMP3072PK2 | 538 | HMPHA3072PK4 | 539 | HMTLSCRN2554 | 121, 768 |
| HLSLW445RF | 231 | HMP3072PK4 | 538 | HMPHA3072PK6 | 539 | HMTLSCRN2560 | 121, 768 |
| HLSLW446L | 229, 550 | HMP3072PK6 | 538 | HMPHA3072PK8 | 539 | HMTLSCRN2566 | 121, 768 |
| HLSLW446LP | 229, 550 | HMP3072PK8 | 538 | HMPHABEORKIT | 532 | HN899900 | 450, 492 |
| HLSLW446R | 229, 550 | HMP3072PK2 | 538 | HMPHASLID20 | 532 | HN899910 | 450, 492 |
| HLSLW446RP | 229, 550 | HMP3072PK4 | 538 | HMPHASLID48 | 532 | HNL11SUPP | 91 |
| HLSLW448L | 230, 551 | HMP3072PK6 | 538 | HMPHASLID60 | 532 | HNL122428BKE | 100 |
| HLSLW448LF | 231 | HMP3072PK8 | 538 | HMPHASLID72 | 532 | HMPHATFWML | 122, 546, 612 |
| HLSLW448R | 230, 551 | HMP3072PK2 | 538 | HMPHATFWML | 122, 546, 612 | HMPHATROUGH20 | 532 |
| HLSLW448RF | 231 | HMP3072PK4 | 538 | HMPHATROUGH20 | 532 | HMPHATROUGH48 | 532 |
| HLSLW448L | 230, 551 | HMP3072PK6 | 538 | HMPHATROUGH48 | 532 | HMPHATROUGH60 | 532 |
| HLSLW448R | 230, 551 | HMP3072PK8 | 538 | HMPHATROUGH60 | 532 | HMPHATROUGH72 | 532 |
| HLSLZ5SC54 | 201, 279, 739 | HMP3072PK2 | 538 | HMPHATROUGH72 | 532 | HMPHAWTWML | 546, 612 |
| HLSLZ5SC60 | 82, 201, 279, 739 | HMP3072PK4 | 538 | HMPHAWTWML | 546, 612 | HMPJUMP | 544 |
| HLSLZ5SC66 | 82, 201, 279, 739 | HMP3072PK6 | 538 | HMPJUMP | 544 | HMPJUMP | 544 |
| HLSLZ5SC72 | 82, 201, 279, 739 | HMP3072PK8 | 538 | HMPJUMP | 544 | HMPJUMP | 544 |
| HLSLZ5SC78 | 82 | HMP3072PK2 | 538 | HMPJUMP | 544 | HMPJUMP | 544 |
| HLSLZ5SC84 | 82, 201, 279, 739 | HMP3072PK4 | 538 | HMPJUMP | 544 | HMPJUMP | 544 |
| HLVPM1 | 108, 175, 236, 319, 355, 369 | HMP3072PK6 | 538 | HMPJUMP | 544 | HMPJUMP | 544 |
| HLVPM2 | 108, 175, 319, 355 | HMP3072PK8 | 538 | HMPJUMP | 544 | HMPJUMP | 544 |
| HMASD | 112, 176, 235, 323, 570, 642 | HMP3072PK2 | 538 | HMPJUMP | 544 | HMPJUMP | 544 |
| HMASTS | 112, 176, 235, 323, 570, 642 | HMP3072PK4 | 538 | HMPJUMP | 544 | HMPJUMP | 544 |
| HMBPOST | 94 | HMP3072PK6 | 538 | HMPJUMP | 544 | HMPJUMP | 544 |
| HMBPOST1 | 632 | HMP3072PK8 | 538 | HMPJUMP | 544 | HMPJUMP | 544 |
| HMBTLEG24 | 94 | HMP3072PK2 | 538 | HMPJUMP | 544 | HMPJUMP | 544 |
| HMP120EL4828 | 526 | HMP3072PK4 | 538 | HMPJUMP | 544 | HMPJUMP | 544 |
| HMP120EL6028 | 526 | HMP3072PK6 | 538 | HMPJUMP | 544 | HMPJUMP | 544 |
| HMP120POST | 526 | HMP3072PK8 | 538 | HMPJUMP | 544 | HMPJUMP | 544 |
| HMP120TROUGH36 | 528 | HMP3072PK2 | 538 | HMPJUMP | 544 | HMPJUMP | 544 |
| HMP120TROUGH42 | 528 | HMP3072PK4 | 538 | HMPJUMP | 544 | HMPJUMP | 544 |
| HMP120TROUGH48 | 528 | HMP3072PK6 | 538 | HMPJUMP | 544 | HMPJUMP | 544 |
| HMP120UB236 | 527 | HMP3072PK8 | 538 | HMPJUMP | 544 | HMPJUMP | 544 |
| HMP120UB242 | 527 | HMP3072PK2 | 538 | HMPJUMP | 544 | HMPJUMP | 544 |
| HMP120UB248 | 527 | HMP3072PK4 | 538 | HMPJUMP | 544 | HMPJUMP | 544 |
| HMP144 | 544, 581 | HMP3072PK6 | 538 | HMPJUMP | 544 | HMPJUMP | 544 |
| HMP2460PK2 | 538 | HMP3072PK8 | 538 | HMPJUMP | 544 | HMPJUMP | 544 |
| HMP2460PK4 | 538 | HMP3072PK2 | 538 | HMPJUMP | 544 | HMPJUMP | 544 |
| HMP2460PK6 | 538 | HMP3072PK4 | 538 | HMPJUMP | 544 | HMPJUMP | 544 |
| HMP2460PK8 | 538 | HMP3072PK6 | 538 | HMPJUMP | 544 | HMPJUMP | 544 |

CROSS REFERENCE INDEX

| MODEL | PAGE | MODEL | PAGE | MODEL | PAGE | MODEL | PAGE |
|----------------|------|----------------|------|--------------|------|---------------|---------|
| HNL1572SD | 61 | HNL2442BF | 50 | HNL3636BHFD | 65 | HNL4936FD | 56 |
| HNL1578FD | 61 | HNL2442LP | 49 | HNL3636BHLD | 64 | HNL4936LD | 55 |
| HNL1578LD | 60 | HNL2442RP | 49 | HNL3636BHxD | 64 | HNL4936LL | 55 |
| HNL1578LL | 60 | HNL2448BF | 50 | HNL3636CU | 46 | HNL4936TB | 104 |
| HNL1578SD | 61 | HNL2448LP | 49 | HNL3636FD | 53 | HNL4936WB | 104 |
| HNL1772RT | 67 | HNL2448RP | 49 | HNL3636LD | 53 | HNL4942FD | 56 |
| HNL203021D2 | 48 | HNL2460DPK | 47 | HNL3636LL | 53 | HNL4942LD | 55 |
| HNL2030MSFC | 69 | HNL2466DPK | 47 | HNL3636TB | 104 | HNL4942LL | 55 |
| HNL203621D2 | 48 | HNL2472DPK | 47 | HNL3636WB | 104 | HNL4948FD | 56 |
| HNL206021D4 | 48 | HNL2472DPS | 47 | HNL3642FD | 53 | HNL4948LD | 55 |
| HNL206021LD2 | 48 | HNL2472LLC | 47 | HNL3642LD | 53 | HNL4948LL | 55 |
| HNL206021RD2 | 48 | HNL2472LP | 47 | HNL3642LL | 53 | HNL4948SD | 57 |
| HNL207221D4 | 48 | HNL2472RLC | 47 | HNL3648FD | 53 | HNL4960FD | 56 |
| HNL207221LD2 | 48 | HNL2472RP | 47 | HNL3648LD | 53 | HNL4960LD | 55 |
| HNL207221RD2 | 48 | HNL291028PBBF | 99 | HNL3648LL | 53 | HNL4960LL | 55 |
| HNL2116MBBF | 69 | HNL291028PFF | 99 | HNL3648SD | 54 | HNL4960SD | 57 |
| HNL2116MBF | 69 | HNL291041PBBFF | 101 | HNL3660FD | 53 | HNL4966FD | 56 |
| HNL2116MFF | 69 | HNL291628PBBF | 99 | HNL3660LD | 53 | HNL4966LD | 55 |
| HNL231028PBBF | 99 | HNL291628PFF | 99 | HNL3660LL | 53 | HNL4966LL | 55 |
| HNL231028PFF | 99 | HNL291641PBBFF | 101 | HNL3660SD | 54 | HNL4966SD | 57 |
| HNL231041PBBFF | 101 | HNL291641PSBBF | 101 | HNL3666FD | 53 | HNL4972FD | 56 |
| HNL231628PBBF | 99 | HNL2930FD | 62 | HNL3666LD | 53 | HNL4972LD | 55 |
| HNL231628PFF | 99 | HNL2930LD | 62 | HNL3666LL | 53 | HNL4972LL | 55 |
| HNL231641PBBFF | 101 | HNL2930LL | 62 | HNL3666SD | 54 | HNL4972SD | 57 |
| HNL231641PSBBF | 101 | HNL2936FD | 62 | HNL3672BUEP | 44 | HNL4978FD | 56 |
| HNL231828PBBF | 99 | HNL2936LD | 62 | HNL3672DPBB | 41 | HNL4978LD | 55 |
| HNL231828PFF | 99 | HNL2936LL | 62 | HNL3672DPBBF | 41 | HNL4978LL | 55 |
| HNL233028PBK | 100 | HNL2942FD | 62 | HNL3672DPBR | 41 | HNL4978SD | 57 |
| HNL233028PLF | 99 | HNL2942LD | 62 | HNL3672DPRB | 41 | HNL7872RLT | 68 |
| HNL233028PSC | 100 | HNL2942LL | 62 | HNL3672DPRBF | 41 | HNL7872RT | 67 |
| HNL233028PSL | 100 | HNL2948FD | 62 | HNL3672DPRR | 41 | HNL8472RLT | 68 |
| HNL233628PBK | 100 | HNL2948LD | 62 | HNL3672FD | 53 | HNL8472RT | 67 |
| HNL233628PLF | 99 | HNL2948LL | 62 | HNL3672LD | 53 | HNLBU3048 | 80 |
| HNL233628PSC | 100 | HNL2948SD | 63 | HNL3672LL | 53 | HNLBU3060 | 80 |
| HNL233628PSL | 100 | HNL2960FD | 62 | HNL3672LPBB | 42 | HNLBU3066 | 80 |
| HNL241850TLL | 74 | HNL2960LD | 62 | HNL3672LPBBF | 42 | HNLBU3072 | 80 |
| HNL241850TLR | 74 | HNL2960LL | 62 | HNL3672LPBR | 42 | HNLBU3078 | 80 |
| HNL241865SFL | 71 | HNL2960SD | 63 | HNL3672LPRB | 43 | HNLBU3084 | 80 |
| HNL241865SFLR | 71 | HNL2966FD | 62 | HNL3672LPRBF | 43 | HNLBW3672 | 80 |
| HNL241865SFX | 71 | HNL2966LD | 62 | HNL3672LPRR | 43 | HNLBW3684 | 80 |
| HNL241865WLL | 73 | HNL2966LL | 62 | HNL3672RPBB | 42 | HNLCDShelf | 104 |
| HNL241865WLR | 73 | HNL2966SD | 63 | HNL3672RPBBF | 42 | HNLECC367224L | 81 |
| HNL241879WLL | 73 | HNL2972FD | 62 | HNL3672RPBR | 42 | HNLECC367224R | 81 |
| HNL241879WLR | 73 | HNL2972LD | 62 | HNL3672RPRB | 43 | HNLECC487224L | 81 |
| HNL242465TLL | 74 | HNL2972LL | 62 | HNL3672RPRBF | 43 | HNLECC487224R | 81 |
| HNL242465TLR | 74 | HNL2972SD | 63 | HNL3672RPRR | 43 | HNLEPI128 | 89 |
| HNL242479TLL | 74 | HNL2978FD | 62 | HNL3672SD | 54 | HNLEPI141 | 89 |
| HNL242479TLR | 74 | HNL2978LD | 62 | HNL3678FD | 53 | HNLEP2428L | 88 |
| HNL2424BK5CL | 75 | HNL2978LL | 62 | HNL3678LD | 53 | HNLEP2428R | 88 |
| HNL2424BK5CR | 75 | HNL2978SD | 63 | HNL3678LL | 53 | HNLEP2441L | 88 |
| HNL243629SC | 71 | HNL301850TLL | 74 | HNL3678SD | 54 | HNLEP2441R | 88 |
| HNL243665SC | 71 | HNL301850TLR | 74 | HNL4272JLEP | 44 | HNLEP247L | 90, 280 |
| HNL243665SLL | 72 | HNL3060DPRF | 41 | HNL4272JREP | 44 | HNLEP247R | 90, 280 |
| HNL243665WL | 73 | HNL3066BUEP | 44 | HNL4872JLEP | 44 | HNLEP3028L | 88 |
| HNL243665WLB | 73 | HNL3066DPRF | 41 | HNL4872JREP | 44 | HNLEP3028R | 88 |
| HNL243665WRBL | 73 | HNL3066LPRF | 43 | HNL4905SSEP | 57 | HNLEP3041L | 88 |
| HNL243679SC | 71 | HNL3066RPRF | 43 | HNL4930BHLD | 64 | HNLEP3041R | 88 |
| HNL243679WL | 73 | HNL3072BUEP | 44 | HNL4930BHxD | 64 | HNLEP307L | 90, 280 |
| HNL243679WLB | 73 | HNL3605SSEP | 54 | HNL4930TB | 104 | HNLEP307R | 90, 280 |
| HNL243679WRBL | 73 | HNL3630BHLD | 64 | HNL4930WB | 104 | HNLEP3628L | 88 |
| HNL2436LD2 | 70 | HNL3630BHxD | 64 | HNL4936BHFD | 65 | HNLEP3628R | 88 |
| HNL2436LD3 | 70 | HNL3630TB | 104 | HNL4936BHLD | 64 | HNLB1013 | 103 |
| HNL2436LD4 | 70 | HNL3630WB | 104 | HNL4936BHxD | 64 | HNLB1018 | 103 |

CROSS REFERENCE INDEX

| MODEL | PAGE | MODEL | PAGE | MODEL | PAGE | MODEL | PAGE |
|-------------|---------|---------------|-------------------|---------------|---|--------------|----------|
| HNLB1613 | 103 | HNLRC2490 | 78 | HPNLSTACK2284 | 772 | HRVBPLATE360 | 449, 607 |
| HNLB1618 | 103 | HNLRC2496 | 78 | HPNLSTACK2290 | 772 | HRVBRI524 | 628 |
| HNLB1818 | 103 | HNLRC3048 | 78, 123 | HPNLSTACK2296 | 772 | HRVBRI524F | 628 |
| HNLB3018 | 103 | HNLRC3060 | 78, 123 | HPNLSTACKBKT | 772 | HRVBRI524P | 628 |
| HNLB3618 | 103 | HNLRC3066 | 78, 123 | HPPMAS | 466, 639 | HRVBRI524PF | 628 |
| HNLLEP2428L | 90 | HNLRC3072 | 78, 123 | HPPMFB | 466, 639 | HRVBRI530 | 628 |
| HNLLEP2428R | 90 | HNLRC3078 | 78 | HPPMPB | 466, 639 | HRVBRI530F | 628 |
| HNLLEP2441L | 90 | HNLRC3084 | 78 | HPPMPS | 466, 639 | HRVBRI530P | 628 |
| HNLLEP2441R | 90 | HNLRC3672 | 78 | HPPMPT | 466, 639 | HRVBRI530PF | 628 |
| HNLLEP3028L | 90 | HNLRC3684 | 78 | HPPMST | 466, 639 | HRVBRI536 | 628 |
| HNLLEP3028R | 90 | HNLTEP2428 | 91 | HPSEAT18ND | 750 | HRVBRI536F | 628 |
| HNLLEP3041L | 90 | HNLTEP3028 | 91 | HPSEAT24ND | 566, 568, 569, 701, 704, 708, 724, 750 | HRVBRI536P | 628 |
| HNLLEP3041R | 90 | HNLTEP3628 | 91 | HPULL2 | 674 | HRVBRI536PF | 628 |
| HNLMP3010 | 84 | HNPMBW24 | 465, 639 | HPULL3 | 674 | HRVBRI542 | 628 |
| HNLMP3028 | 84 | HNPMBW30 | 465, 639 | HPWRMOD2 | 107, 122, 179, 243, 286, 546, 641 | HRVBRI542F | 628 |
| HNLMP3610 | 84 | HNPMBW36 | 465, 639 | HPWRMOD2UWM | 107, 122, 179, 243, 546, 612, 641 | HRVBRI548 | 628 |
| HNLMP3628 | 84 | HNPMBW42 | 465, 639 | HPWRMOD2WC | 107, 122, 179, 243, 377, 384, 390, 402, 546, 612, 641 | HRVBRI548F | 628 |
| HNLMP4210 | 84 | HNPMBW48 | 465, 639 | HPWRMOD3UWM | 107, 122, 179, 243, 546, 612, 641 | HRVBRI560 | 628 |
| HNLMP4228 | 84 | HNPMBW60 | 465, 639 | HPWRMOD3WC | 107, 122, 179, 243, 377, 384, 390, 402, 546, 612, 641 | HRVBRI560F | 628 |
| HNLMP4810 | 84 | HOLEG12 | 630 | HRABAB | 469 | HRVBRI566 | 628 |
| HNLMP4828 | 84 | HOLEG18 | 630 | HRFF3524P | 447 | HRVBRI566F | 628 |
| HNLMP5410 | 84 | HOLEG24 | 630 | HRFF3530P | 447 | HRVBRI572 | 628 |
| HNLMP5428 | 84 | HOLEG30 | 630 | HRFF3536P | 447 | HRVBRI572F | 628 |
| HNLMP6010 | 84 | HP3231 | 383 | HRFF3542P | 447 | HRVCI5FFV | 454 |
| HNLMP6028 | 84 | HP3235R | 382 | HRFF3548P | 447 | HRVCI5FFVF | 454 |
| HNLMP6610 | 84 | HP3236L | 382 | HRFF3560P | 447 | HRVCI5PF | 454 |
| HNLMP6628 | 84 | HP3251R | 382 | HRFF4224P | 447 | HRVCI5PFF | 454 |
| HNLMP7210 | 84 | HP3261 | 382 | HRFF4230P | 447 | HRVCI5PFT | 454 |
| HNLMP7228 | 84 | HP3262 | 382 | HRFF4236P | 447 | HRVCI5PFV | 454 |
| HNLMP7810 | 84 | HP3265R | 382 | HRFF4242P | 447 | HRVCI5PFVF | 454 |
| HNLMP7828 | 84 | HP3266L | 382 | HRFF4248P | 447 | HRVCI5PL | 452 |
| HNLMP8410 | 84 | HP3276 | 382 | HRFF4260P | 447 | HRVCI5PLF | 452 |
| HNLMP8428 | 84 | HPC180G | 45, 164, 299, 346 | HRFF5024P | 447 | HRVCI5PLF | 452 |
| HNLMP9010 | 84 | HPC180W | 45 | HRFF5030P | 447 | HRVCI5PS | 452 |
| HNLMP9028 | 84 | HPC190X | 44, 93, 281 | HRFF5036P | 447 | HRVCI5PSF | 452 |
| HNLMP9610 | 84 | HPC191X | 44, 93, 281 | HRFF5042P | 447 | HRVCI5PT | 452 |
| HNLMP9628 | 84 | HPCW1 | 566, 701, 750 | HRFF5048P | 447 | HRVCI5PTF | 452 |
| HNLPB1028 | 103 | HPD2PNBRK2L | 633 | HRFF5060P | 447 | HRVCI5PX | 452 |
| HNLPB1041 | 103 | HPD2PNBRK2R | 633 | HRFF5724P | 447 | HRVCI5PXF | 452 |
| HNLPB1628 | 103 | HPMARKER1 | 774 | HRFF5730P | 447 | HRVC22PFT | 454 |
| HNLPB1641 | 103 | HPNLSTACK1524 | 772 | HRFF5736P | 447 | HRVC22PFV | 454 |
| HNLPB1828 | 103 | HPNLSTACK1530 | 772 | HRFF5742P | 447 | HRVC22PFV | 454 |
| HNLPT2416 | 102 | HPNLSTACK1536 | 772 | HRFF5748P | 447 | HRVC22PL | 452 |
| HNLPT2418 | 102 | HPNLSTACK1542 | 772 | HRFF5760P | 447 | HRVC22PLF | 452 |
| HNLPT3016 | 102 | HPNLSTACK1548 | 772 | HRFF6524P | 447 | HRVC22PLF | 452 |
| HNLRC2042V | 79 | HPNLSTACK1554 | 772 | HRFF6530P | 447 | HRVC22PSF | 452 |
| HNLRC2048V | 79 | HPNLSTACK1560 | 772 | HRFF6536P | 447 | HRVC22PT | 452 |
| HNLRC2430 | 78 | HPNLSTACK1566 | 772 | HRFF6542P | 447 | HRVC22PTF | 452 |
| HNLRC2430V | 79 | HPNLSTACK1572 | 772 | HRFF6548P | 447 | HRVC22PX | 452 |
| HNLRC2436 | 78 | HPNLSTACK1578 | 772 | HRFF6560P | 447 | HRVC22PXF | 452 |
| HNLRC2436V | 79 | HPNLSTACK1584 | 772 | HRFTAB | 469 | HRVC30PF | 454 |
| HNLRC2442 | 78 | HPNLSTACK1590 | 772 | HRVBPLATE336 | 449, 607 | HRVC30PFF | 454 |
| HNLRC2442V | 79 | HPNLSTACK1596 | 772 | HRVBPLATE342 | 449, 607 | HRVC30PFF | 454 |
| HNLRC2448 | 78, 123 | HPNLSTACK2224 | 772 | HRVBPLATE348 | 449, 607 | HRVC30PFT | 454 |
| HNLRC2448V | 79 | HPNLSTACK2230 | 772 | | | HRVC30PFV | 454 |
| HNLRC2454 | 78 | HPNLSTACK2236 | 772 | | | HRVC30PL | 452 |
| HNLRC2454V | 79 | HPNLSTACK2242 | 772 | | | HRVC30PLF | 452 |
| HNLRC2460 | 78, 123 | HPNLSTACK2248 | 772 | | | HRVC30PLF | 452 |
| HNLRC2460V | 79 | HPNLSTACK2254 | 772 | | | HRVC30PS | 452 |
| HNLRC2466 | 78, 123 | HPNLSTACK2260 | 772 | | | HRVC30PSF | 452 |
| HNLRC2472 | 78, 123 | HPNLSTACK2266 | 772 | | | HRVC30PT | 452 |
| HNLRC2478 | 78 | HPNLSTACK2272 | 772 | | | HRVC30PTF | 452 |
| HNLRC2484 | 78 | HPNLSTACK2278 | 772 | | | HRVC30PXF | 452 |
| | | | | | | HRVC35GP | 473 |

CROSS REFERENCE INDEX

| MODEL | PAGE | MODEL | PAGE | MODEL | PAGE | MODEL | PAGE |
|------------|---------------|------------|----------|-----------------|------|-----------------|------|
| HRVC35PCE | 454, 499, 634 | HRVC65PL | 452 | HRVF3536P | 445 | HRVG353018GGNS | 478 |
| HRVC35PCM | 454, 499, 634 | HRVC65PLF | 452 | HRVF3542P | 445 | HRVG353018GGNSG | 478 |
| HRVC35PF | 454 | HRVC65PS | 452 | HRVF3548P | 445 | HRVG353024GGNS | 478 |
| HRVC35PFF | 454 | HRVC65PSF | 452 | HRVF3560P | 445 | HRVG353024GGNSG | 478 |
| HRVC35PL | 452 | HRVC65PT | 452 | HRVF4224P | 445 | HRVG3530GGL | 476 |
| HRVC35PLF | 452 | HRVC65PTF | 452 | HRVF4230P | 445 | HRVG3530GGLG | 476 |
| HRVC35PS | 452 | HRVC65PW | 454 | HRVF4236P | 445 | HRVG3530GGR | 475 |
| HRVC35PSF | 452 | HRVC65PWF | 454 | HRVF4242P | 445 | HRVG3530GGRG | 475 |
| HRVC35PT | 452 | HRVC65PX | 452 | HRVF4248P | 445 | HRVG3530L | 470 |
| HRVC35PTF | 452 | HRVC65PXF | 452 | HRVF4260P | 445 | HRVG3530LG | 471 |
| HRVC35PX | 452 | HRVC65PY2 | 453 | HRVF5024P | 445 | HRVG3533L | 470 |
| HRVC35PXF | 452 | HRVC65PY2F | 453 | HRVF5030P | 445 | HRVG3533LG | 471 |
| HRVC35PY2 | 453 | HRVC65PY3 | 453 | HRVF5036P | 445 | HRVG3536GGL | 476 |
| HRVC35PY2F | 453 | HRVC65PY3F | 453 | HRVF5042P | 445 | HRVG3536GGLG | 476 |
| HRVC35PY3 | 453 | HRVC7FFV | 454 | HRVF5048P | 445 | HRVG3536GGR | 475 |
| HRVC35PY3F | 453 | HRVC7FFVF | 454 | HRVF5060P | 445 | HRVG3536GGRG | 475 |
| HRVC42GP | 473 | HRVC7PFT | 454 | HRVF5724P | 445 | HRVG3536GGT | 477 |
| HRVC42PF | 454 | HRVC7PFV | 454 | HRVF5730P | 445 | HRVG3536GGTG | 477 |
| HRVC42PFF | 454 | HRVC7PFVF | 454 | HRVF5736P | 445 | HRVG3536L | 470 |
| HRVC42PL | 452 | HRVC7PL | 452 | HRVF5742P | 445 | HRVG3536LG | 471 |
| HRVC42PLF | 452 | HRVC7PLF | 452 | HRVF5748P | 445 | HRVG3539L | 470 |
| HRVC42PS | 452 | HRVC7PS | 452 | HRVF5760P | 445 | HRVG3539LG | 471 |
| HRVC42PSF | 452 | HRVC7PSF | 452 | HRVF6524P | 445 | HRVG3542GGL | 476 |
| HRVC42PT | 452 | HRVC7PT | 452 | HRVF6530P | 445 | HRVG3542GGLG | 476 |
| HRVC42PTF | 452 | HRVC7PTF | 452 | HRVF6536P | 445 | HRVG3542GGR | 475 |
| HRVC42PX | 452 | HRVC7PX | 452 | HRVF6542P | 445 | HRVG3542GGRG | 475 |
| HRVC42PXF | 452 | HRVC7PXF | 452 | HRVF6548P | 445 | HRVG3542GGT | 477 |
| HRVC42PY2 | 453 | HRVC80PF | 454 | HRVF6560P | 445 | HRVG3542GGTG | 477 |
| HRVC42PY2F | 453 | HRVC80PFF | 454 | HRVFFOOT | 447 | HRVG3542L | 470 |
| HRVC42PY3 | 453 | HRVC80PL | 452 | HRVFSB24 | 448 | HRVG3542LG | 471 |
| HRVC42PY3F | 453 | HRVC80PLF | 452 | HRVFSB30 | 448 | HRVG3545L | 470 |
| HRVC50GP | 473 | HRVC80PS | 452 | HRVFSB36 | 448 | HRVG3545LG | 471 |
| HRVC50PF | 454 | HRVC80PSF | 452 | HRVFSB42 | 448 | HRVG3548GGL | 476 |
| HRVC50PFF | 454 | HRVC80PT | 452 | HRVFSB48 | 448 | HRVG3548GGLG | 476 |
| HRVC50PL | 452 | HRVC80PTF | 452 | HRVFSB60 | 448 | HRVG3548GGR | 475 |
| HRVC50PLF | 452 | HRVC80PX | 452 | HRVFSBW24 | 455 | HRVG3548GGRG | 475 |
| HRVC50PS | 452 | HRVC80PXF | 452 | HRVFSBW30 | 455 | HRVG3548GGT | 477 |
| HRVC50PSF | 452 | HRVCE | 473 | HRVFSBW36 | 455 | HRVG3548GGTG | 477 |
| HRVC50PT | 452 | HRVCLG24 | 418, 630 | HRVFSBW42 | 455 | HRVG3548L | 470 |
| HRVC50PTF | 452 | HRVCLG30 | 418, 630 | HRVFSBW48 | 455 | HRVG3548LG | 471 |
| HRVC50PX | 452 | HRVCM | 473 | HRVFSBW60 | 455 | HRVG3551L | 470 |
| HRVC50PXF | 452 | HRVD0742T | 450 | HRVG351824GGNS | 478 | HRVG3551LG | 471 |
| HRVC50PY2 | 453 | HRVD9542P | 450 | HRVG351824GGNSG | 478 | HRVG3560GGL | 476 |
| HRVC50PY2F | 453 | HRVEP1129L | 418, 630 | HRVG351830GGNS | 478 | HRVG3560GGLG | 476 |
| HRVC50PY3 | 453 | HRVEP1129R | 418, 630 | HRVG351830GGNSG | 478 | HRVG3560GGR | 475 |
| HRVC50PY3F | 453 | HRVEP2429L | 418, 630 | HRVG3518GGL | 476 | HRVG3560GGRG | 475 |
| HRVC57PF | 454 | HRVEP2429R | 418, 630 | HRVG3518GGLG | 476 | HRVG3560GGT | 477 |
| HRVC57PFF | 454 | HRVEP3029L | 418, 630 | HRVG3518GGR | 475 | HRVG3560GGTG | 477 |
| HRVC57PL | 452 | HRVEP3029R | 418, 630 | HRVG3518GGRG | 475 | HRVG3560L | 470 |
| HRVC57PLF | 452 | HRVF1524 | 448 | HRVG3518GGT | 477 | HRVG3560LG | 471 |
| HRVC57PS | 452 | HRVF1530 | 448 | HRVG3518GGTG | 477 | HRVG3563L | 470 |
| HRVC57PSF | 452 | HRVF1536 | 448 | HRVG352418GGNS | 478 | HRVG3563LG | 471 |
| HRVC57PT | 452 | HRVF1542 | 448 | HRVG352418GGNSG | 478 | HRVG3572GGT | 477 |
| HRVC57PTF | 452 | HRVF1548 | 448 | HRVG352430GGNS | 478 | HRVG3572GGTG | 477 |
| HRVC57PX | 452 | HRVF1560 | 448 | HRVG352430GGNSG | 478 | HRVG3575L | 470 |
| HRVC57PXF | 452 | HRVF3024 | 448 | HRVG3524GGL | 476 | HRVG3575LG | 471 |
| HRVC57PY2 | 453 | HRVF3030 | 448 | HRVG3524GGLG | 476 | HRVG421824GGNS | 478 |
| HRVC57PY2F | 453 | HRVF3036 | 448 | HRVG3524GGR | 475 | HRVG421824GGNSG | 478 |
| HRVC57PY3 | 453 | HRVF3042 | 448 | HRVG3524GGRG | 475 | HRVG421830GGNS | 478 |
| HRVC57PY3F | 453 | HRVF3048 | 448 | HRVG3524L | 470 | HRVG421830GGNSG | 478 |
| HRVC65GP | 473 | HRVF3060 | 448 | HRVG3524LG | 471 | HRVG4218GGL | 476 |
| HRVC65PF | 454 | HRVF3524P | 445 | HRVG3527L | 470 | HRVG4218GGLG | 476 |
| HRVC65PFF | 454 | HRVF3530P | 445 | HRVG3527LG | 471 | HRVG4218GGR | 475 |

CROSS REFERENCE INDEX

| MODEL | PAGE | MODEL | PAGE | MODEL | PAGE | MODEL | PAGE |
|-----------------|------|-----------------|------|--------------|------|-------------|----------|
| HRVG4218GGRG | 475 | HRVG4260L | 470 | HRVG5048GGLG | 476 | HRVSHV30 | 588 |
| HRVG4218GGT | 477 | HRVG4260LG | 471 | HRVG5048GGR | 475 | HRVSHV36 | 588 |
| HRVG4218GGTG | 477 | HRVG4263L | 470 | HRVG5048GGRG | 475 | HRVSHV42 | 588 |
| HRVG422418GGNS | 478 | HRVG4263LG | 471 | HRVG5048GGT | 477 | HRVSHV48 | 588 |
| HRVG422418GGNSG | 478 | HRVG4272GGT | 477 | HRVG5048GGTG | 477 | HRVSS24 | 449 |
| HRVG422430GGNS | 478 | HRVG4272GGTG | 477 | HRVG5048L | 470 | HRVSS30 | 449 |
| HRVG422430GGNSG | 478 | HRVG4275L | 470 | HRVG5048LG | 471 | HRVSS36 | 449 |
| HRVG4224GGL | 476 | HRVG4275LG | 471 | HRVG5051L | 470 | HRVSS42 | 449 |
| HRVG4224GGLG | 476 | HRVG501824GGNS | 478 | HRVG5051LG | 471 | HRVSS48 | 449 |
| HRVG4224GGR | 475 | HRVG501824GGNSG | 478 | HRVG5060GGL | 476 | HRVSS60 | 449 |
| HRVG4224GGRG | 475 | HRVG501830GGNS | 478 | HRVG5060GGLG | 476 | HRVT0724F | 463 |
| HRVG4224L | 470 | HRVG501830GGNSG | 478 | HRVG5060GGR | 475 | HRVT0724FF | 463 |
| HRVG4224LG | 471 | HRVG5018GGL | 476 | HRVG5060GGRG | 475 | HRVT0724T | 456, 464 |
| HRVG4227L | 470 | HRVG5018GGLG | 476 | HRVG5060GGT | 477 | HRVT0730F | 463 |
| HRVG4227LG | 471 | HRVG5018GGR | 475 | HRVG5060GGTG | 477 | HRVT0730FF | 463 |
| HRVG423018GGNS | 478 | HRVG5018GGRG | 475 | HRVG5060L | 470 | HRVT0730T | 456, 464 |
| HRVG423018GGNSG | 478 | HRVG5018GGT | 477 | HRVG5060LG | 471 | HRVT0736F | 463 |
| HRVG423024GGNS | 478 | HRVG5018GGTG | 477 | HRVG5063L | 470 | HRVT0736FF | 463 |
| HRVG423024GGNSG | 478 | HRVG502418GGNS | 478 | HRVG5063LG | 471 | HRVT0736T | 456, 464 |
| HRVG4230GGL | 476 | HRVG502418GGNSG | 478 | HRVG5072GGT | 477 | HRVT0742F | 463 |
| HRVG4230GGLG | 476 | HRVG502430GGNS | 478 | HRVG5072GGTG | 477 | HRVT0742FF | 463 |
| HRVG4230GGR | 475 | HRVG502430GGNSG | 478 | HRVG5075L | 470 | HRVT0742T | 456, 464 |
| HRVG4230GGRG | 475 | HRVG5024GGL | 476 | HRVG5075LG | 471 | HRVT0748F | 463 |
| HRVG4230L | 470 | HRVG5024GGLG | 476 | HRVGLSK | 473 | HRVT0748FF | 463 |
| HRVG4230LG | 471 | HRVG5024GGR | 475 | HRVGMSK | 473 | HRVT0748T | 456, 464 |
| HRVG4233L | 470 | HRVG5024GGRG | 475 | HRVGTGG | 479 | HRVT0754F | 463 |
| HRVG4233LG | 471 | HRVG5024L | 470 | HRVOH1530RM | 586 | HRVT0754FF | 463 |
| HRVG4236GGL | 476 | HRVG5024LG | 471 | HRVOH1536RM | 586 | HRVT0760F | 463 |
| HRVG4236GGLG | 476 | HRVG5027L | 470 | HRVOH1542RM | 586 | HRVT0760FF | 463 |
| HRVG4236GGR | 475 | HRVG5027LG | 471 | HRVOH1548RM | 586 | HRVT0760T | 456, 464 |
| HRVG4236GGRG | 475 | HRVG503018GGNS | 478 | HRVOH1560RM | 586 | HRVT0766F | 463 |
| HRVG4236GGT | 477 | HRVG503018GGNSG | 478 | HRVOH24FM | 586 | HRVT0766FF | 463 |
| HRVG4236GGTG | 477 | HRVG503024GGNS | 478 | HRVOH30FM | 586 | HRVT0772F | 463 |
| HRVG4236L | 470 | HRVG503024GGNSG | 478 | HRVOH36FM | 586 | HRVT0772FF | 463 |
| HRVG4236LG | 471 | HRVG5030GGL | 476 | HRVOH42FM | 586 | HRVT0778F | 463 |
| HRVG4239L | 470 | HRVG5030GGLG | 476 | HRVOH48FM | 586 | HRVT0778FF | 463 |
| HRVG4239LG | 471 | HRVG5030GGR | 475 | HRVOH60FM | 586 | HRVT0784F | 463 |
| HRVG4242GGL | 476 | HRVG5030GGRG | 475 | HRVOH72FM | 586 | HRVT0784FF | 463 |
| HRVG4242GGLG | 476 | HRVG5030L | 470 | HRVOHV24HLA | 589 | HRVT0790F | 463 |
| HRVG4242GGR | 475 | HRVG5030LG | 471 | HRVOHV24HMA | 588 | HRVT0790FF | 463 |
| HRVG4242GGRG | 475 | HRVG5033L | 470 | HRVOHV30HLA | 589 | HRVT0796F | 463 |
| HRVG4242GGT | 477 | HRVG5033LG | 471 | HRVOHV30HMA | 588 | HRVT0796FF | 463 |
| HRVG4242GGTG | 477 | HRVG5036GGL | 476 | HRVOHV36HLA | 589 | HRVT1524CK | 469 |
| HRVG4242L | 470 | HRVG5036GGLG | 476 | HRVOHV36HMA | 588 | HRVT1524E | 458 |
| HRVG4242LG | 471 | HRVG5036GGR | 475 | HRVOHV42HLA | 589 | HRVT1524F | 463 |
| HRVG4245L | 470 | HRVG5036GGRG | 475 | HRVOHV42HMA | 588 | HRVT1524FF | 463 |
| HRVG4245LG | 471 | HRVG5036GGT | 477 | HRVOHV48HLA | 589 | HRVT1524G | 461 |
| HRVG4248GGL | 476 | HRVG5036GGTG | 477 | HRVOHV48HMA | 588 | HRVT1524HS2 | 460 |
| HRVG4248GGLG | 476 | HRVG5036L | 470 | HRVOMOD | 455 | HRVT1524M | 467 |
| HRVG4248GGR | 475 | HRVG5036LG | 471 | HRVP24P | 610 | HRVT1524PM | 468 |
| HRVG4248GGRG | 475 | HRVG5039L | 470 | HRVP30P | 610 | HRVT1524R | 462 |
| HRVG4248GGT | 477 | HRVG5039LG | 471 | HRVP36P | 610 | HRVT1524T | 456 |
| HRVG4248GGTG | 477 | HRVG5042GGL | 476 | HRVP42P | 610 | HRVT1524W | 465 |
| HRVG4248L | 470 | HRVG5042GGLG | 476 | HRVP48P | 610 | HRVT1530CK | 469 |
| HRVG4248LG | 471 | HRVG5042GGR | 475 | HRVP60P | 610 | HRVT1530E | 458 |
| HRVG4251L | 470 | HRVG5042GGRG | 475 | HRVSH24 | 586 | HRVT1530F | 463 |
| HRVG4251LG | 471 | HRVG5042GGT | 477 | HRVSH30 | 586 | HRVT1530FF | 463 |
| HRVG4260GGL | 476 | HRVG5042GGTG | 477 | HRVSH36 | 586 | HRVT1530G | 461 |
| HRVG4260GGLG | 476 | HRVG5042L | 470 | HRVSH42 | 586 | HRVT1530HS2 | 460 |
| HRVG4260GGR | 475 | HRVG5042LG | 471 | HRVSH48 | 586 | HRVT1530M | 467 |
| HRVG4260GGRG | 475 | HRVG5045L | 470 | HRVSH60 | 586 | HRVT1530PM | 468 |
| HRVG4260GGT | 477 | HRVG5045LG | 471 | HRVSH72 | 586 | HRVT1530R | 462 |
| HRVG4260GGTG | 477 | HRVG5048GGL | 476 | HRVSHV24 | 588 | HRVT1530T | 456 |

CROSS REFERENCE INDEX

| MODEL | PAGE | MODEL | PAGE | MODEL | PAGE | MODEL | PAGE |
|-------------|------|-------------|------|-------------|------|-----------------|--------------------|
| HRVTI530W | 465 | HRVT2248T | 456 | HRVT3736HS2 | 460 | HRVTC66 | 446 |
| HRVTI536CK | 469 | HRVT2260T | 456 | HRVT3736T | 456 | HRVTC66F | 446 |
| HRVTI536E | 458 | HRVT3024CK | 469 | HRVT3742E | 458 | HRVTC72 | 446 |
| HRVTI536F | 463 | HRVT3024E | 458 | HRVT3742HS2 | 460 | HRVTC72F | 446 |
| HRVTI536FF | 463 | HRVT3024G | 461 | HRVT3742T | 456 | HRVTC78 | 446 |
| HRVTI536G | 461 | HRVT3024HS2 | 460 | HRVT3748E | 458 | HRVTC78F | 446 |
| HRVTI536HS2 | 460 | HRVT3024M | 467 | HRVT3748HS2 | 460 | HRVTC84 | 446 |
| HRVTI536M | 467 | HRVT3024P | 464 | HRVT3748T | 456 | HRVTC84F | 446 |
| HRVTI536PM | 468 | HRVT3024PM | 468 | HRVT3760E | 458 | HRVTC90 | 446 |
| HRVTI536R | 462 | HRVT3024R | 462 | HRVT3760HS2 | 460 | HRVTC90F | 446 |
| HRVTI536T | 456 | HRVT3024T | 456 | HRVT3760T | 456 | HRVTC96 | 446 |
| HRVTI536W | 465 | HRVT3030CK | 469 | HRVT4524E | 459 | HRVTC96F | 446 |
| HRVTI542CK | 469 | HRVT3030E | 458 | HRVT4524T | 457 | HRVTRAYM | 467 |
| HRVTI542E | 458 | HRVT3030G | 461 | HRVT4530E | 459 | HRVUP24 | 596 |
| HRVTI542F | 463 | HRVT3030HS2 | 460 | HRVT4530T | 457 | HRVUP30 | 596 |
| HRVTI542FF | 463 | HRVT3030M | 467 | HRVT4536E | 459 | HRVUP36 | 596 |
| HRVTI542G | 461 | HRVT3030P | 464 | HRVT4536T | 457 | HRVUP42 | 596 |
| HRVTI542HS2 | 460 | HRVT3030PM | 468 | HRVT4542E | 459 | HRVUP48 | 596 |
| HRVTI542M | 467 | HRVT3030R | 462 | HRVT4542T | 457 | HRVUP60 | 596 |
| HRVTI542PM | 468 | HRVT3030T | 456 | HRVT4548E | 459 | HS30ABC | 663 |
| HRVTI542R | 462 | HRVT3036CK | 469 | HRVT4548T | 457 | HS42ABC | 663 |
| HRVTI542T | 456 | HRVT3036E | 458 | HRVT4560E | 459 | HS60ABC | 663 |
| HRVTI542W | 465 | HRVT3036G | 461 | HRVT4560T | 457 | HS72ABC | 663 |
| HRVTI548CK | 469 | HRVT3036HS2 | 460 | HRVT5224E | 459 | HS82ABC | 663 |
| HRVTI548E | 458 | HRVT3036M | 467 | HRVT5224T | 457 | HSC1842 | 664 |
| HRVTI548F | 463 | HRVT3036P | 464 | HRVT5230E | 459 | HSC1872 | 664 |
| HRVTI548FF | 463 | HRVT3036PM | 468 | HRVT5230T | 457 | HSC2472 | 664 |
| HRVTI548G | 461 | HRVT3036R | 462 | HRVT5236E | 459 | HSCABD02 | 556, 662, 676 |
| HRVTI548HS2 | 460 | HRVT3036T | 456 | HRVT5236T | 457 | HSCABD10 | 556, 662, 676 |
| HRVTI548M | 467 | HRVT3042CK | 469 | HRVT5242E | 459 | HSCACW25 | 675 |
| HRVTI548PM | 468 | HRVT3042E | 458 | HRVT5242T | 457 | HSCACW35 | 675 |
| HRVTI548R | 462 | HRVT3042G | 461 | HRVT5248E | 459 | HSCACW50 | 675 |
| HRVTI548T | 456 | HRVT3042HS2 | 460 | HRVT5248T | 457 | HSCAFD02 | 556, 662, 676, 747 |
| HRVTI548W | 465 | HRVT3042M | 467 | HRVT5260E | 459 | HSCAFD10 | 556, 662, 676, 747 |
| HRVTI554F | 463 | HRVT3042P | 464 | HRVT5260T | 457 | HSCAHR12 | 675 |
| HRVTI554FF | 463 | HRVT3042PM | 468 | HRVT6024E | 459 | HSCAHR15 | 674 |
| HRVTI560CK | 469 | HRVT3042R | 462 | HRVT6024T | 457 | HSCAPB | 675 |
| HRVTI560E | 458 | HRVT3042T | 456 | HRVT6030E | 459 | HSCAUC1824 | 556, 676 |
| HRVTI560F | 463 | HRVT3048CK | 469 | HRVT6030T | 457 | HSCAUC1830 | 556, 676 |
| HRVTI560FF | 463 | HRVT3048E | 458 | HRVT6036E | 459 | HSCAUC1836 | 556, 676 |
| HRVTI560G | 461 | HRVT3048G | 461 | HRVT6036T | 457 | HSCAWS6520 | 675 |
| HRVTI560HS2 | 460 | HRVT3048HS2 | 460 | HRVT6042E | 459 | HSCAWS6524 | 675 |
| HRVTI560M | 467 | HRVT3048M | 467 | HRVT6042T | 457 | HSCAWS6530 | 675 |
| HRVTI560PM | 468 | HRVT3048P | 464 | HRVT6048E | 459 | HSCF223018BFL | 555, 671 |
| HRVTI560R | 462 | HRVT3048PM | 468 | HRVT6048T | 457 | HSCF223018BFM | 553, 669 |
| HRVTI560T | 456 | HRVT3048R | 462 | HRVT6060E | 459 | HSCF223018O | 553, 669 |
| HRVTI560W | 465 | HRVT3048T | 456 | HRVT6060T | 457 | HSCF223618BFL | 555, 671 |
| HRVTI566F | 463 | HRVT3060CK | 469 | HRVTB11 | 474 | HSCF223618BFM | 553, 669 |
| HRVTI566FF | 463 | HRVT3060E | 458 | HRVTB18 | 474 | HSCF223618O | 553, 669 |
| HRVTI572F | 463 | HRVT3060G | 461 | HRVTC24 | 446 | HSCF224818LBFOL | 555, 671 |
| HRVTI572FF | 463 | HRVT3060HS2 | 460 | HRVTC24F | 446 | HSCF224818LBFOM | 553, 669 |
| HRVTI578F | 463 | HRVT3060M | 467 | HRVTC30 | 446 | HSCF224818RBFOL | 555, 671 |
| HRVTI578FF | 463 | HRVT3060P | 464 | HRVTC30F | 446 | HSCF224818RBFOM | 553, 669 |
| HRVTI584F | 463 | HRVT3060PM | 468 | HRVTC36 | 446 | HSCF226018LBFOL | 555, 671 |
| HRVTI584FF | 463 | HRVT3060R | 462 | HRVTC36F | 446 | HSCF226018LBFOM | 553, 669 |
| HRVTI590F | 463 | HRVT3060T | 456 | HRVTC42 | 446 | HSCF226018RBFOL | 555, 671 |
| HRVTI590FF | 463 | HRVT3724E | 458 | HRVTC42F | 446 | HSCF226018RBFOM | 553, 669 |
| HRVTI596F | 463 | HRVT3724HS2 | 460 | HRVTC48 | 446 | HSCF227218LBFOL | 555, 671 |
| HRVTI596FF | 463 | HRVT3724T | 456 | HRVTC48F | 446 | HSCF227218LBFOM | 553, 669 |
| HRVT2224T | 456 | HRVT3730E | 458 | HRVTC54 | 446 | HSCF227218RBFOL | 555, 671 |
| HRVT2230T | 456 | HRVT3730HS2 | 460 | HRVTC54F | 446 | HSCF227218RBFOM | 553, 669 |
| HRVT2236T | 456 | HRVT3730T | 456 | HRVTC60 | 446 | HSCK24BF | 675 |
| HRVT2242T | 456 | HRVT3736E | 458 | HRVTC60F | 446 | HSCK30BF | 675 |

CROSS REFERENCE INDEX

| MODEL | PAGE | MODEL | PAGE | MODEL | PAGE | MODEL | PAGE |
|----------------|------|-----------------|----------|--------------------|----------|--------------------|------|
| HSCK300 | 675 | HSCLP652418LME | 696 | HSDLP421218RL | 695 | HSISLAUTIPYB7236S2 | 737 |
| HSCK36BF | 675 | HSCLP652418RL | 695 | HSDLP421218RLE | 697 | HSISLAUTIPYB7236S3 | 737 |
| HSCK36O | 675 | HSCLP652418RLE | 697 | HSDLP421218RM | 694 | HSISLAUTIPYB7236S6 | 737 |
| HSCKTPS | 498 | HSCLP652418RM | 694 | HSDLP421218RME | 696 | HSISLAUTIPYB8436S2 | 737 |
| HSCLF501218LL | 695 | HSCLP652418RME | 696 | HSDLP651218LL | 695 | HSISLAUTIPYB8436S7 | 737 |
| HSCLF501218LLE | 697 | HSCP223018BFL | 554, 670 | HSDLP651218LLE | 697 | HSISLAUT2PNB2418S1 | 735 |
| HSCLF501218LM | 694 | HSCP223018BFM | 552, 668 | HSDLP651218LM | 694 | HSISLAUT2PNB3018S1 | 735 |
| HSCLF501218LME | 696 | HSCP223018O | 552, 668 | HSDLP651218LME | 696 | HSISLAUT2PNB3618S1 | 735 |
| HSCLF501218RL | 695 | HSCP223618BFL | 554, 670 | HSDLP651218RL | 695 | HSISLAUT2PNB3618S3 | 735 |
| HSCLF501218RLE | 697 | HSCP223618BFM | 552, 668 | HSDLP651218RLE | 697 | HSISLAUT2PNB4218S1 | 735 |
| HSCLF501218RM | 694 | HSCP223618O | 552, 668 | HSDLP651218RM | 694 | HSISLAUT2PNB4818S2 | 735 |
| HSCLF501218RME | 696 | HSCP224818LBFOL | 554, 670 | HSDLP651218RME | 696 | HSISLAUT2PNB4818S4 | 735 |
| HSCLF502418LL | 695 | HSCP224818LBFOM | 552, 668 | HSDMP244 | 421 | HSISLAUT2PNB6018S2 | 735 |
| HSCLF502418LLE | 697 | HSCP224818RBFOL | 554, 670 | HSDMP249 | 421 | HSISLAUT2PNB6018S5 | 735 |
| HSCLF502418LM | 694 | HSCP224818RBFOM | 552, 668 | HSDMP304 | 421 | HSISLAUT2PNB7218S2 | 735 |
| HSCLF502418LME | 696 | HSCP226018LBFOL | 554, 670 | HSDMP309 | 421 | HSISLAUT2PNB7218S3 | 735 |
| HSCLF502418RL | 695 | HSCP226018LBFOM | 552, 668 | HSDMP364 | 421 | HSISLAUT2PNB7218S6 | 735 |
| HSCLF502418RLE | 697 | HSCP226018RBFOL | 554, 670 | HSDMP369 | 421 | HSISLAUT2PNB8418S2 | 735 |
| HSCLF502418RM | 694 | HSCP226018RBFOM | 552, 668 | HSDMP424 | 421 | HSISLAUT2PNB8418S7 | 735 |
| HSCLF502418RME | 696 | HSCP227218LBFOL | 554, 670 | HSDMP429 | 421 | HSISLAUT2PYB4818S2 | 736 |
| HSCLF651218LL | 695 | HSCP227218LBFOM | 552, 668 | HSDMP484 | 421 | HSISLAUT2PYB4818S4 | 736 |
| HSCLF651218LLE | 697 | HSCP227218RBFOL | 554, 670 | HSDMP489 | 421 | HSISLAUT2PYB4836S2 | 736 |
| HSCLF651218LM | 694 | HSCP227218RBFOM | 552, 668 | HSDMP544 | 421 | HSISLAUT2PYB4836S4 | 736 |
| HSCLF651218LME | 696 | HSDBK29 | 420 | HSDMP549 | 421 | HSISLAUT2PYB6018S2 | 736 |
| HSCLF651218RL | 695 | HSDCDPA29L | 420 | HSDMP604 | 421 | HSISLAUT2PYB6018S5 | 736 |
| HSCLF651218RLE | 697 | HSDCDPA29R | 420 | HSDMP609 | 421 | HSISLAUT2PYB6036S2 | 736 |
| HSCLF651218RM | 694 | HSDCMP3614 | 421 | HSDMP664 | 421 | HSISLAUT2PYB6036S5 | 736 |
| HSCLF651218RME | 696 | HSDCMP3629 | 421 | HSDMP669 | 421 | HSISLAUT2PYB7218S2 | 736 |
| HSCLF652418LL | 695 | HSDCMP4214 | 421 | HSDMP724 | 421 | HSISLAUT2PYB7218S3 | 736 |
| HSCLF652418LLE | 697 | HSDCMP4229 | 421 | HSDMP729 | 421 | HSISLAUT2PYB7218S6 | 736 |
| HSCLF652418LM | 694 | HSDCMP4814 | 421 | HSDRK29 | 420 | HSISLAUT2PYB7236S2 | 736 |
| HSCLF652418LME | 696 | HSDCMP4829 | 421 | HSDSL2429F | 418 | HSISLAUT2PYB7236S3 | 736 |
| HSCLF652418RL | 695 | HSDCMP6014 | 421 | HSDSL29 | 419 | HSISLAUT2PYB7236S6 | 736 |
| HSCLF652418RLE | 697 | HSDCMP6029 | 421 | HSDSL3029F | 418 | HSISLAUT2PYB8418S2 | 736 |
| HSCLF652418RM | 694 | HSDCMP7214 | 421 | HSFCF283018BBFL | 672 | HSISLAUT2PYB8418S7 | 736 |
| HSCLF652418RME | 696 | HSDCMP7229 | 421 | HSFCF283018BBFM | 672 | HSISLAUT2PYB8436S2 | 736 |
| HSCLP501218LL | 695 | HSDDL29 | 419 | HSFCP283018BBFL | 672 | HSISLAUT2PYB8436S7 | 736 |
| HSCLP501218LLE | 697 | HSDDPA29L | 420 | HSFCP283018BBFM | 672 | HSISLAUTNPNB2418S1 | 734 |
| HSCLP501218LM | 694 | HSDDPA29R | 420 | HSISLACB2P4842S2 | 738 | HSISLAUTNPNB2436S1 | 734 |
| HSCLP501218LME | 696 | HSDEP1129F | 418 | HSISLACB2P4842S4 | 738 | HSISLAUTNPNB3018S1 | 734 |
| HSCLP501218RL | 695 | HSDEP2429F | 418 | HSISLACB2P6042S5 | 738 | HSISLAUTNPNB3036S1 | 734 |
| HSCLP501218RLE | 697 | HSDEP3029F | 418 | HSISLACB2P7242S3 | 738 | HSISLAUTNPNB3618S1 | 734 |
| HSCLP501218RM | 694 | HSDG | 419 | HSISLACB2P7242S6 | 738 | HSISLAUTNPNB3618S3 | 734 |
| HSCLP501218RME | 696 | HSDLF421218LL | 695 | HSISLACB2P8442S7 | 738 | HSISLAUTNPNB3636S1 | 734 |
| HSCLP502418LL | 695 | HSDLF421218LLE | 697 | HSISLACENB1842 | 738 | HSISLAUTNPNB3636S3 | 734 |
| HSCLP502418LLE | 697 | HSDLF421218LM | 694 | HSISLACESP3642 | 738, 739 | HSISLAUTNPNB4218S1 | 734 |
| HSCLP502418LM | 694 | HSDLF421218LME | 696 | HSISLACEYB1842L | 738 | HSISLAUTNPNB4236S1 | 734 |
| HSCLP502418LME | 696 | HSDLF421218RL | 695 | HSISLACEYB1842R | 738 | HSISLAUTNPNB4818S1 | 734 |
| HSCLP502418RL | 695 | HSDLF421218RLE | 697 | HSISLACEYB3642 | 738 | HSISLAUTNPNB4818S2 | 734 |
| HSCLP502418RLE | 697 | HSDLF421218RM | 694 | HSISLACO3642 | 739 | HSISLAUTNPNB4818S4 | 734 |
| HSCLP502418RM | 694 | HSDLF421218RME | 696 | HSISLAFB2P6042S2 | 738 | HSISLAUTNPNB4836S1 | 734 |
| HSCLP502418RME | 696 | HSDLF651218LL | 695 | HSISLAFB2P7242S2 | 738 | HSISLAUTNPNB4836S2 | 734 |
| HSCLP651218LL | 695 | HSDLF651218LLE | 697 | HSISLAFB2P8442S2 | 738 | HSISLAUTNPNB4836S4 | 734 |
| HSCLP651218LLE | 697 | HSDLF651218LM | 694 | HSISLAFENB1842 | 738 | HSISLAUTNPNB6018S1 | 734 |
| HSCLP651218LM | 694 | HSDLF651218LME | 696 | HSISLAFESP3642 | 738, 739 | HSISLAUTNPNB6018S2 | 734 |
| HSCLP651218LME | 696 | HSDLF651218RL | 695 | HSISLAFEBY1842L | 738 | HSISLAUTNPNB6018S5 | 734 |
| HSCLP651218RL | 695 | HSDLF651218RLE | 697 | HSISLAFEBY1842R | 738 | HSISLAUTNPNB6036S1 | 734 |
| HSCLP651218RLE | 697 | HSDLF651218RM | 694 | HSISLAFEBY3642 | 738 | HSISLAUTNPNB6036S2 | 734 |
| HSCLP651218RM | 694 | HSDLF651218RME | 696 | HSISLAFO3642 | 739 | HSISLAUTNPNB6036S5 | 734 |
| HSCLP651218RME | 696 | HSDLP421218LL | 695 | HSISLAUTIPYB4836S2 | 737 | HSISLAUTNPNB7218S1 | 734 |
| HSCLP652418LL | 695 | HSDLP421218LLE | 697 | HSISLAUTIPYB4836S4 | 737 | HSISLAUTNPNB7218S2 | 734 |
| HSCLP652418LLE | 697 | HSDLP421218LM | 694 | HSISLAUTIPYB6036S2 | 737 | HSISLAUTNPNB7218S3 | 734 |
| HSCLP652418LM | 694 | HSDLP421218LME | 696 | HSISLAUTIPYB6036S5 | 737 | HSISLAUTNPNB7218S6 | 734 |

CROSS REFERENCE INDEX

| MODEL | PAGE | MODEL | PAGE | MODEL | PAGE | MODEL | PAGE |
|---------------------|----------|---------------------|-------------------|-----------------|----------|------------------|----------|
| HSISLAUTNPB7236S1 | 734 | HSPSBX281524FFM(?) | 699 | HSTF422424RFFM | 561, 684 | HSTSF421824RFFL | 691 |
| HSISLAUTNPB7236S2 | 734 | HSPSBX281530BBFL(?) | 702 | HSTF501824LFFL | 691 | HSTSF421824RFFM | 689 |
| HSISLAUTNPB7236S3 | 734 | HSPSBX281530BBFM(?) | 699 | HSTF501824LFFM | 689 | HSTSF422424LBBFL | 564, 687 |
| HSISLAUTNPB7236S6 | 734 | HSPSBX281530FFL(?) | 702 | HSTF501824RFFL | 691 | HSTSF422424LBBFM | 562, 685 |
| HSISLAUTNPB8418S1 | 734 | HSPSBX281530FFM(?) | 699 | HSTF501824RFFM | 689 | HSTSF422424LFFL | 564, 687 |
| HSISLAUTNPB8418S2 | 734 | HSPSSF281518BBFL(?) | 703 | HSTF502424LBBFL | 563, 686 | HSTSF422424LFFM | 562, 685 |
| HSISLAUTNPB8418S7 | 734 | HSPSSF281518BBFM(?) | 700 | HSTF502424LBBFM | 561, 684 | HSTSF422424RBBFL | 564, 687 |
| HSISLAUTNPB8436S1 | 734 | HSPSSF281518FFL(?) | 703 | HSTF502424LFFL | 563, 686 | HSTSF422424RBBFM | 562, 685 |
| HSISLAUTNPB8436S2 | 734 | HSPSSF281518FFM(?) | 700 | HSTF502424LFFM | 561, 684 | HSTSF422424RFFL | 564, 687 |
| HSISLAUTNPB8436S7 | 734 | HSPSSF281524BBFL(?) | 703 | HSTF502424RBBFL | 563, 686 | HSTSF422424RFFM | 562, 685 |
| HSLACW50 | 674 | HSPSSF281524BBFM(?) | 700 | HSTF502424RBBFM | 561, 684 | HSTSF501824LFFL | 691 |
| HSLACW57 | 674 | HSPSSF281524FFL(?) | 703 | HSTF502424RFFL | 563, 686 | HSTSF501824LFFM | 689 |
| HSLDIGMGR | 698, 726 | HSPSSF281524FFM(?) | 700 | HSTF502424RFFM | 561, 684 | HSTSF501824RFFL | 691 |
| HSLDIGPRG | 698, 726 | HSPSSF281530BBFL(?) | 703 | HSTF651824LFFL | 691 | HSTSF501824RFFM | 689 |
| HSLF283018FFL | 673 | HSPSSF281530BBFM(?) | 700 | HSTF651824LFFM | 689 | HSTSF502424LBBFL | 564, 687 |
| HSLF283018FFM | 673 | HSPSSF281530FFL(?) | 703 | HSTF651824RFFL | 691 | HSTSF502424LBBFM | 562, 685 |
| HSLF283618FFL | 673 | HSPSSF281530FFM(?) | 700 | HSTF651824RFFM | 689 | HSTSF502424LFFL | 564, 687 |
| HSLF283618FFM | 673 | HSQLF422418LL | 695 | HSTF652424LBBFL | 563, 686 | HSTSF502424LFFM | 562, 685 |
| HSLP283018FFL | 673 | HSQLF422418LLE | 697 | HSTF652424LBBFM | 561, 684 | HSTSF502424RBBFL | 564, 687 |
| HSLP283018FFM | 673 | HSQLF422418LM | 694 | HSTF652424LFFL | 563, 686 | HSTSF502424RBBFM | 562, 685 |
| HSLP283618FFL | 673 | HSQLF422418LME | 696 | HSTF652424LFFM | 561, 684 | HSTSF502424RFFL | 564, 687 |
| HSLP283618FFM | 673 | HSQLF422418RL | 695 | HSTF652424RBBFL | 563, 686 | HSTSF502424RFFM | 562, 685 |
| HSLRFID100C | 698 | HSQLF422418RLE | 697 | HSTF652424RBBFM | 561, 684 | HSTSF651824LFFL | 691 |
| HSLRFID100S | 698 | HSQLF422418RM | 694 | HSTF652424RFFL | 563, 686 | HSTSF651824LFFM | 689 |
| HSLRFID25C | 698 | HSQLF422418RME | 696 | HSTF652424RFFM | 561, 684 | HSTSF651824RFFL | 691 |
| HSLRFID25S | 698 | HSQLF652418LL | 695 | HSTP421824LFFL | 690 | HSTSF651824RFFM | 689 |
| HSLRFID5C | 698 | HSQLF652418LLE | 697 | HSTP421824LFFM | 688 | HSTSF652424LBBFL | 564, 687 |
| HSLRFID5S | 698 | HSQLF652418LM | 694 | HSTP421824RFFL | 690 | HSTSF652424LBBFM | 562, 685 |
| HSPAKI5 | 700 | HSQLF652418LME | 696 | HSTP421824RFFM | 688 | HSTSF652424LFFL | 564, 687 |
| HSPFSF221518BFL(?) | 568, 703 | HSQLF652418RL | 695 | HSTP422424LBBFL | 559, 682 | HSTSF652424LFFM | 562, 685 |
| HSPFSF221518BFM(?) | 566, 700 | HSQLF652418RLE | 697 | HSTP422424LBBFM | 557, 680 | HSTSF652424RBBFL | 564, 687 |
| HSPFSF221524BFL(?) | 568, 703 | HSQLF652418RM | 694 | HSTP422424LFFL | 559, 682 | HSTSF652424RBBFM | 562, 685 |
| HSPFSF221524BFM(?) | 566, 700 | HSQLF652418RME | 696 | HSTP422424LFFM | 557, 680 | HSTSF652424RFFL | 564, 687 |
| HSPHI181518BFL(?) | 702 | HSQLP422418LL | 695 | HSTP422424RBBFL | 559, 682 | HSTSF652424RFFM | 562, 685 |
| HSPHI181518BFM(?) | 699 | HSQLP422418LLE | 697 | HSTP422424RBBFM | 557, 680 | HSTSP421824LFFL | 690 |
| HSPHI181524BFL(?) | 702 | HSQLP422418LM | 694 | HSTP422424RFFL | 559, 682 | HSTSP421824LFFM | 688 |
| HSPHI181524BFM(?) | 699 | HSQLP422418LME | 696 | HSTP422424RFFM | 557, 680 | HSTSP421824RFFL | 690 |
| HSPHI181530BFL(?) | 702 | HSQLP422418RL | 695 | HSTP501824LFFL | 690 | HSTSP421824RFFM | 688 |
| HSPHI181530BFM(?) | 699 | HSQLP422418RLE | 697 | HSTP501824LFFM | 688 | HSTSP422424LBBFL | 560, 683 |
| HSPM211518BFL(?) | 567, 702 | HSQLP422418RM | 694 | HSTP501824RFFL | 690 | HSTSP422424LBBFM | 558, 681 |
| HSPM211518BFM(?) | 565, 699 | HSQLP422418RME | 696 | HSTP501824RFFM | 688 | HSTSP422424LFFL | 560, 683 |
| HSPM211524BFL(?) | 567, 702 | HSQLP652418LL | 695 | HSTP502424LBBFL | 559, 682 | HSTSP422424LFFM | 558, 681 |
| HSPM211524BFM(?) | 565, 699 | HSQLP652418LLE | 697 | HSTP502424LBBFM | 557, 680 | HSTSP422424RBBFL | 560, 683 |
| HSPM271518BBFL(?) | 702 | HSQLP652418LM | 694 | HSTP502424LFFL | 559, 682 | HSTSP422424RBBFM | 558, 681 |
| HSPM271518BBFM(?) | 699 | HSQLP652418LME | 696 | HSTP502424LFFM | 557, 680 | HSTSP422424RFFL | 560, 683 |
| HSPM271518FFL(?) | 702 | HSQLP652418RL | 695 | HSTP502424RBBFL | 559, 682 | HSTSP422424RFFM | 558, 681 |
| HSPM271518FFM(?) | 699 | HSQLP652418RLE | 697 | HSTP502424RBBFM | 557, 680 | HSTSP501824LFFL | 690 |
| HSPM271524BBFL(?) | 702 | HSQLP652418RM | 694 | HSTP502424RFFL | 559, 682 | HSTSP501824LFFM | 688 |
| HSPM271524BBFM(?) | 699 | HSQLP652418RME | 696 | HSTP502424RFFM | 557, 680 | HSTSP501824RFFL | 690 |
| HSPM271524FFL(?) | 702 | HSTAKL | 564, 687 | HSTP651824LFFL | 690 | HSTSP501824RFFM | 688 |
| HSPM271524FFM(?) | 699 | HSTAKR | 564, 687 | HSTP651824LFFM | 688 | HSTSP502424LBBFL | 560, 683 |
| HSPM271530BBFL(?) | 702 | HSTB2W1 | 82, 229, 284, 633 | HSTP651824RFFL | 690 | HSTSP502424LBBFM | 558, 681 |
| HSPM271530BBFM(?) | 699 | HSTF421824LFFL | 691 | HSTP651824RFFM | 688 | HSTSP502424LFFL | 560, 683 |
| HSPM271530FFL(?) | 702 | HSTF421824LFFM | 689 | HSTP652424LBBFL | 559, 682 | HSTSP502424LFFM | 558, 681 |
| HSPM271530FFM(?) | 699 | HSTF421824RFFL | 691 | HSTP652424LBBFM | 557, 680 | HSTSP502424RBBFL | 560, 683 |
| HSPRAY | 774 | HSTF421824RFFM | 689 | HSTP652424LFFL | 559, 682 | HSTSP502424RBBFM | 558, 681 |
| HSPSBX281518BBFL(?) | 702 | HSTF422424LBBFL | 563, 686 | HSTP652424LFFM | 557, 680 | HSTSP502424RFFL | 560, 683 |
| HSPSBX281518BBFM(?) | 699 | HSTF422424LBBFM | 561, 684 | HSTP652424RBBFL | 559, 682 | HSTSP502424RFFM | 558, 681 |
| HSPSBX281518FFL(?) | 702 | HSTF422424LFFL | 563, 686 | HSTP652424RBBFM | 557, 680 | HSTSP651824LFFL | 690 |
| HSPSBX281518FFM(?) | 699 | HSTF422424LFFM | 561, 684 | HSTP652424RFFL | 559, 682 | HSTSP651824LFFM | 688 |
| HSPSBX281524BBFL(?) | 702 | HSTF422424RBBFL | 563, 686 | HSTP652424RFFM | 557, 680 | HSTSP651824RFFL | 690 |
| HSPSBX281524BBFM(?) | 699 | HSTF422424RBBFM | 561, 684 | HSTSF421824LFFL | 691 | HSTSP651824RFFM | 688 |
| HSPSBX281524FFL(?) | 702 | HSTF422424RFFL | 563, 686 | HSTSF421824LFFM | 689 | HSTSP652424LBBFL | 560, 683 |

CROSS REFERENCE INDEX

| MODEL | PAGE | MODEL | PAGE | MODEL | PAGE | MODEL | PAGE |
|------------------|----------|---------------|------------------------|---------------|---|------------|---------------|
| HSTSP652424LBBFM | 558, 681 | HTCOL52 | 68, 173, 317, 353, 369 | HUVFOWT | 760 | HWD244830P | 619 |
| HSTSP652424LFFL | 560, 683 | HTWTH | 588 | HUVHEWT | 760 | HWD245430P | 619 |
| HSTSP652424LFFM | 558, 681 | HUVAHS | 761 | HUVLSWT | 760 | HWD246030P | 619 |
| HSTSP652424RBBFL | 560, 683 | HUVABLS2424L | 766 | HUVMAWT | 760 | HWD246630P | 619 |
| HSTSP652424RBBFM | 558, 681 | HUVABLS2424R | 766 | HUVMAWT24 | 761 | HWD247230P | 619 |
| HSTSP652424RFFL | 560, 683 | HUVABLS2430L | 766 | HUVMAWT48 | 761 | HWD304824P | 619 |
| HSTSP652424RFFM | 558, 681 | HUVABLS2430R | 766 | HUVMBHS48 | 761 | HWD305424P | 619 |
| HSWEEPA2 | 322, 354 | HUVABLS3024L | 766 | HUVMBHS96 | 761 | HWD306024P | 619 |
| HSWEEPA3 | 322, 354 | HUVABLS3024R | 766 | HUVMMFS55 | 762 | HWD306624P | 619 |
| HSWEEPC2 | 322, 354 | HUVABLS3030L | 766 | HUVMMFS63 | 762 | HWD307224P | 619 |
| HSWEEPC3 | 322, 354 | HUVABLS3030R | 766 | HUVPAWT | 760 | HWJ58ABLP | 625 |
| HSWF421218LL | 693 | HUVABLS3624L | 766 | HUVREWT | 760 | HWJ58ABRP | 625 |
| HSWF421218LM | 692 | HUVABLS3624R | 766 | HUVSLFS3254L | 763 | HWJ58BBLP | 625 |
| HSWF421218RL | 693 | HUVABLS3630L | 766 | HUVSLFS3254LC | 763 | HWJ58BBRP | 625 |
| HSWF421218RM | 692 | HUVABLS3630R | 766 | HUVSLFS3259L | 763 | HWJ59ABLP | 625 |
| HSWF421224LL | 693 | HUVAUS482413 | 766 | HUVSLFS3259LC | 763 | HWJ59ABRP | 625 |
| HSWF421224LM | 692 | HUVAUS482420 | 766 | HUVSLFS3267L | 763 | HWJ59BBLP | 625 |
| HSWF421224RL | 693 | HUVAUS483013 | 766 | HUVSLFS3267LC | 763 | HWJ59BBRP | 625 |
| HSWF421224RM | 692 | HUVAUS483020 | 766 | HUVSLFS4054L | 763 | HWMCCLIPLG | 107, 242, 283 |
| HSWF501218LL | 693 | HUVAUS602413 | 766 | HUVSLFS4054LC | 763 | HWMCCLIPSM | 107, 242 |
| HSWF501218LM | 692 | HUVAUS602420 | 766 | HUVSLFS4059L | 763 | HWP2460P | 625 |
| HSWF501218RL | 693 | HUVAUS603013 | 766 | HUVSLFS4059LC | 763 | HWP2466P | 625 |
| HSWF501218RM | 692 | HUVAUS603020 | 766 | HUVSLFS4067L | 763 | HWP2472P | 625 |
| HSWF501224LL | 693 | HUVAUS722413 | 766 | HUVSLFS4067LC | 763 | HWP3060P | 625 |
| HSWF501224LM | 692 | HUVAUS722420 | 766 | HUVSLFS4754L | 763 | HWP3066P | 625 |
| HSWF501224RL | 693 | HUVAUS723013 | 766 | HUVSLFS4754LC | 763 | HWP3072P | 625 |
| HSWF501224RM | 692 | HUVAUS723020 | 766 | HUVSLFS4759L | 763 | HWR1824P | 617 |
| HSWF651218LL | 693 | HUVCFCT24 | 761 | HUVSLFS4759LC | 763 | HWR1830P | 617 |
| HSWF651218LM | 692 | HUVCFCT48 | 761 | HUVSLFS4767L | 763 | HWR1836P | 617 |
| HSWF651218RL | 693 | HUVDPS1324 | 765 | HUVSLFS4767LC | 763 | HWR1842P | 617 |
| HSWF651218RM | 692 | HUVDPS1330 | 765 | HUVSSWT | 760 | HWR1848P | 617 |
| HSWF651224LL | 693 | HUVDPS2024 | 765 | HUVSTAHSD | 761 | HWR1854P | 617 |
| HSWF651224LM | 692 | HUVDPS2030 | 765 | HUVSTAHSP | 761 | HWR1860P | 617 |
| HSWF651224RL | 693 | HUVDRWT | 760 | HUVSTAHST | 761 | HWR1866P | 617 |
| HSWF651224RM | 692 | HUVDSA01348 | 765 | HUVSTBHSD | 761 | HWR1872P | 617 |
| HSWP421218LL | 693 | HUVDSA01360 | 765 | HUVSTBHSP | 761 | HWR2424P | 617 |
| HSWP421218LM | 692 | HUVDSA01372 | 765 | HUVSTBHST | 761 | HWR2430P | 617 |
| HSWP421218RL | 693 | HUVDSA02048 | 765 | HUVTOWT | 760 | HWR2436P | 617 |
| HSWP421218RM | 692 | HUVDSA02060 | 765 | HUVTOWT24 | 761 | HWR2436PN | 529 |
| HSWP421224LL | 693 | HUVDSA02072 | 765 | HUVTOWT48 | 761 | HWR2442P | 617 |
| HSWP421224LM | 692 | HUVDSA0EM1348 | 765 | HUVTRWT | 760 | HWR2448P | 617 |
| HSWP421224RL | 693 | HUVDSA0EM1360 | 765 | HUVVWVT | 760 | HWR2448PN | 529, 530 |
| HSWP421224RM | 692 | HUVDSA0EM1372 | 765 | HV-UT1 | 566, 636, 751 | HWR2454P | 617 |
| HSWP501218LL | 693 | HUVDSA0EM2048 | 765 | HVFB20R | 636 | HWR2460P | 617 |
| HSWP501218LM | 692 | HUVDSA0EM2060 | 765 | HVFB23R | 636 | HWR2460PN | 530 |
| HSWP501218RL | 693 | HUVDSA0EM2072 | 765 | HVFF20R | 636 | HWR2466P | 617 |
| HSWP501218RM | 692 | HUVDSBS2048 | 582, 766 | HVFF23R | 636 | HWR2472P | 617 |
| HSWP501224LL | 693 | HUVDSBS2060 | 582, 766 | HVL991 | 114, 127, 181, 240, 327, 360, 372, 379, 386, 392, 404, 571, 644 | HWR2472PN | 530 |
| HSWP501224LM | 692 | HUVDSBS2072 | 582, 766 | HVPWLBK24 | 82, 284 | HWR2484P | 617 |
| HSWP501224RL | 693 | HUVDSHAB4813 | 766 | HVPWLBK30 | 82, 284 | HWR3024P | 618 |
| HSWP501224RM | 692 | HUVDSHAB4820 | 766 | HWC3624P | 620 | HWR3030P | 618 |
| HSWP651218LL | 693 | HUVDSHAB6013 | 766 | HWC4224P | 620 | HWR3036P | 618 |
| HSWP651218LM | 692 | HUVDSHAB6020 | 766 | HWC4230P | 620 | HWR3042P | 618 |
| HSWP651218RL | 693 | HUVDSHAB7213 | 766 | HWC4824P | 620 | HWR3048P | 618 |
| HSWP651218RM | 692 | HUVDSHAB7220 | 766 | HWC4830P | 620 | HWR3048PN | 530 |
| HSWP651224LL | 693 | HUVDSSE1324 | 765 | HWC72 | 664 | HWR3054P | 618 |
| HSWP651224LM | 692 | HUVDSSE1330 | 765 | HWCS3624P | 621 | HWR3060P | 618 |
| HSWP651224RL | 693 | HUVDSSE2024 | 765 | HWCS4224P | 621 | HWR3060PN | 530 |
| HSWP651224RM | 692 | HUVDSSE2030 | 765 | HWCS4230P | 621 | HWR3066P | 618 |
| HT48ND | 407 | HUVDSSM1324 | 765 | HWCS4824P | 621 | HWR3072P | 618 |
| HT60ND | 407 | HUVDSSM1330 | 765 | HWCS4830P | 621 | HWR3072PN | 530 |
| HT66ND | 407 | HUVDSSM2024 | 765 | HWSA2 | | HWR3084P | 618 |
| HT72ND | 407 | HUVDSSM2030 | 765 | | | HWSA2 | 632 |

CROSS REFERENCE INDEX

| MODEL | PAGE | MODEL | PAGE | MODEL | PAGE | MODEL | PAGE |
|-------------|------|-----------|------|-----------|------|---------------------------|------|
| HWSB2 | 632 | HWWT1518F | 256 | HWWT3024P | 261 | HWWT4536V | 260 |
| HWSR24 | 633 | HWWT1518L | 259 | HWWT3030F | 257 | HWWT4542F | 257 |
| HWSR30 | 633 | HWWT1518P | 261 | HWWT3030L | 259 | HWWT4542M | 258 |
| HWSR36 | 633 | HWWT1524F | 256 | HWWT3030M | 258 | HWWT4542V | 260 |
| HWSR42 | 633 | HWWT1524L | 259 | HWWT3030P | 261 | HWWT4548F | 257 |
| HWSR48 | 633 | HWWT1524P | 261 | HWWT3036F | 257 | HWWT4548M | 258 |
| HWV73AALP | 623 | HWWT1524T | 262 | HWWT3036L | 259 | HWWT4548V | 260 |
| HWV73AARP | 624 | HWWT1530F | 256 | HWWT3036M | 258 | HWWT4554F | 257 |
| HWV73BALP | 623 | HWWT1530L | 259 | HWWT3036P | 261 | HWWT4554M | 258 |
| HWV73BARP | 624 | HWWT1530M | 258 | HWWT3036V | 260 | HWWT4554V | 260 |
| HWV75AALP | 623 | HWWT1530P | 261 | HWWT3042F | 257 | HWWT4560F | 257 |
| HWV75AARP | 624 | HWWT1530T | 262 | HWWT3042V | 260 | HWWT4560M | 258 |
| HWV75ABLP | 623 | HWWT1536F | 256 | HWWT3048F | 257 | HWWT718F | 256 |
| HWV75ABRP | 624 | HWWT1536L | 259 | HWWT3048V | 260 | HWWT718L | 259 |
| HWV75BALP | 623 | HWWT1536M | 258 | HWWT3054F | 257 | HWWT718P | 261 |
| HWV75BARP | 624 | HWWT1536P | 261 | HWWT3060F | 257 | HWWT724F | 256 |
| HWV75BBLP | 623 | HWWT1536T | 262 | HWWT3718F | 257 | HWWT724L | 259 |
| HWV75BBRP | 624 | HWWT1542F | 256 | HWWT3718L | 259 | HWWT724P | 261 |
| HWV93AALP | 623 | HWWT1542T | 262 | HWWT3724F | 257 | HWWT724T | 262 |
| HWV93AARP | 624 | HWWT1548F | 256 | HWWT3724L | 259 | HWWT730F | 256 |
| HWV93BALP | 623 | HWWT1548T | 262 | HWWT3730F | 257 | HWWT730L | 259 |
| HWV93BARP | 624 | HWWT1554F | 256 | HWWT3730L | 259 | HWWT730P | 261 |
| HWV95AALP | 623 | HWWT1554T | 262 | HWWT3730M | 258 | HWWT730T | 262 |
| HWV95AARP | 624 | HWWT1560F | 256 | HWWT3736F | 257 | HWWT736F | 256 |
| HWV95ABLP | 623 | HWWT1560T | 262 | HWWT3736L | 259 | HWWT736L | 259 |
| HWV95ABRP | 624 | HWWT2218F | 256 | HWWT3736M | 258 | HWWT736P | 261 |
| HWV95BALP | 623 | HWWT2218L | 259 | HWWT3736V | 260 | HWWT736T | 262 |
| HWV95BARP | 624 | HWWT2218P | 261 | HWWT3742F | 257 | HWWT742F | 256 |
| HWV95BBLP | 623 | HWWT2224F | 256 | HWWT3742M | 258 | HWWT742T | 262 |
| HWV95BBRP | 624 | HWWT2224L | 259 | HWWT3742V | 260 | HWWT748F | 256 |
| HWWAC | 264 | HWWT2224P | 261 | HWWT3748F | 257 | HWWT748T | 262 |
| HWWAH | 264 | HWWT2230F | 256 | HWWT3748M | 258 | HWWT754F | 256 |
| HWWAP | 264 | HWWT2230L | 259 | HWWT3748V | 260 | HWWT754T | 262 |
| HWWAPH | 264 | HWWT2230M | 258 | HWWT3754F | 257 | HWWT760F | 256 |
| HWWARAIL18 | 263 | HWWT2230P | 261 | HWWT3754M | 258 | HWWT760T | 262 |
| HWWARAIL24 | 263 | HWWT2236F | 256 | HWWT3754V | 260 | SPLH-ABND-GALGLSS.M482171 | 472 |
| HWWARAIL30 | 263 | HWWT2236L | 259 | HWWT3760F | 257 | SPLH-ABND-GALGLSS.M482172 | 472 |
| HWWARAIL36 | 263 | HWWT2236M | 258 | HWWT3760M | 258 | SPLH-ABND-GALGLSS.M482173 | 472 |
| HWWARAIL42 | 263 | HWWT2236P | 261 | HWWT4518F | 257 | SPLH-ABND-GALGLSS.M482174 | 472 |
| HWWARAIL48 | 263 | HWWT2242F | 256 | HWWT4518L | 259 | SPLH-ABND-GALGLSS.M482175 | 472 |
| HWWARAIL54 | 263 | HWWT2248F | 256 | HWWT4524F | 257 | SPLH-ABND-GALGLSS.M482176 | 472 |
| HWWARAIL60 | 263 | HWWT2254F | 256 | HWWT4524L | 259 | SPLH-ABND-GALGLSS.M482177 | 472 |
| HWWASB | 264 | HWWT2260F | 256 | HWWT4530F | 257 | SPLH-ABND-GALGLSS.M482178 | 472 |
| HWWASHELF18 | 263 | HWWT3018F | 257 | HWWT4530L | 259 | SPLH-ABND-GALGLSS.M482179 | 472 |
| HWWASHELF24 | 263 | HWWT3018L | 259 | HWWT4530M | 258 | SPLH-ABND-GALGLSS.M482180 | 472 |
| HWWASHELF30 | 263 | HWWT3018P | 261 | HWWT4536F | 257 | SPLH-ABND-GALGLSS.M482181 | 472 |
| HWWASHELF36 | 263 | HWWT3024F | 257 | HWWT4536L | 259 | SPLH-ABND-GALGLSS.M482182 | 472 |
| HWWAST | 264 | HWWT3024L | 259 | HWWT4536M | 258 | SPLH-ABND-GALGLSS.M482183 | 472 |
| HWWATS | 264 | | | | | | |

NOTES

NOTES

NOTES

INFORMATION ON ORDERING PARTS

When parts are needed to repair HON products, the following guidelines should be followed to expedite the process.

1. Warranty orders are submitted on HON Ready via the Quick Claim tool. To purchase repair parts, please visit HONAccessories.com which can be found on HON.com.
2. There are no discounts applied to parts. Pricing quoted is the net value. Parts pricing is subject to change without notice.
3. For a part not covered by warranty applicable shipping charges will apply.
4. All keys are \$6.00 each plus a shipping and handling fee of \$3.00 per shipping location.
5. Parts may be paid for with an approved credit card. Approved Cards: MasterCard, VISA and American Express.
6. Payment terms for invoiced parts are Net 30 days.
7. Due to short leadtimes on parts, no changes will be accepted after the order has been placed.
8. When placing a **warranty** parts order:

If the product is under warranty, the product serial number must be provided. Most finished goods products have a serial number placed on them at the factory. The label containing the serial number is located:

Vertical Files — right side of the uppermost drawer

Lateral Files — left side of the uppermost drawer or shelf

Desk Towers — outside of top drawer

Desks, Credenzas, & Returns — on the outside, kneespace side of the top drawer. Fully extend the drawer to find it.

Desks, Credenzas, Corner Units, Bridges, Peninsulas & Returns without drawers — underside of top

Tables and Stands — underside of the top

Table Trucks — underside of side rail

Cabinets & Bookcases — left inner side of the case

Modular Component Top and Backs — underside of top

Modular End Panels — top inside surface

Reception Stations — top inside surface of back panel

Organizers — top inside surface of left end panel near back panel

Vertical Paper Manager — back panel inside surface near top

Pedestals — bottom drawer right side exterior

Seating — underside of the seat

Panels — underside of the top cap

Hutches, Storage Units, Overhead Storage — underside of the shelf

Hanging Bookshelves — underside of shelf

NOTE: Removal of the serial number tag from the product voids the warranty.

An important note regarding Product Serial Numbers:

HON desks, tables, chairs, files and systems components are tagged with a serial number. This number helps us identify *when and where your product was made*, and to identify and correct the root causes for the problem. NEITHER THE DEALER NOR THE CONSUMER SHOULD REMOVE THIS TAG UNDER ANY CIRCUMSTANCES. To do so immediately voids your Warranty coverage for that particular item *and prevents us from further identifying it*. Instead, please transcribe the number and call your Dealer.